

# Instruction Manual

UM8-40 SERIES

## High Voltage Power Supply

MODEL :  
SERIAL# :  
DATE :

**SPELLMAN  
HIGH VOLTAGE ELECTRONICS  
CORPORATION**

475 Wireless Blvd.  
Hauppauge, New York, 11788

+1(631) 630-3000\*FAX: +1(631) 435-1620\*  
E-mail: [sales@spellmanhv.com](mailto:sales@spellmanhv.com)  
Website: [www.spellmanhv.com](http://www.spellmanhv.com)

## IMPORTANT SAFETY PRECAUTIONS

### SAFETY

THIS POWER SUPPLY GENERATES VOLTAGES THAT ARE DANGEROUS AND MAY BE FATAL.  
OBSERVE EXTREME CAUTION WHEN WORKING WITH THIS EQUIPMENT.

High voltage power supplies must always be grounded.

Do not touch connections unless the equipment is off and the Capacitance of both the load and power supply is discharged.

Allow five minutes for discharge of internal capacitance of the power supply.

Do not ground yourself or work under wet or damp conditions.

### SERVICING SAFETY

Maintenance may require removing the instrument cover with the power on.

Servicing should be done by qualified personnel aware of the electrical hazards.

**WARNING** note in the text call attention to hazards in operation of these units that could lead to possible injury or death.

**CAUTION** notes in the text indicate procedures to be followed to avoid possible damage to equipment.

Copyright © 2000, Spellman High Voltage Electronics Corporation. All Rights Reserved.  
This information contained in this publication is derived in part from proprietary and patent data. This information has been prepared for the express purpose of assisting operating and maintenance personnel in the efficient use of the model described herein, and publication of this information does not convey any right to reproduce it or to use it for any purpose other than in connection with installation, operation, and maintenance of the equipment described.

# WICHTIGE SICHERHEITSHINWEISE

## SICHERHEIT

DIESES HOCHSPANNUNGSNETZTEIL ERZEUGT LEBENSGEFÄHRLICHE HOCHSPANNUNG.  
SEIN SIE SEHR VORSICHTIG BEI DER ARBEIT MIT DIESEM GERÄT.

Das Hochspannungsnetzteil muß immer geerdet sein.

Berühren Sie die Stecker des Netzteiles nur, wenn das Gerät ausgeschaltet ist und die elektrischen Kapazitäten des Netzteiles und der angeschlossenen Last entladen sind.

Die internen Kapazitäten des Hochspannungsnetzteiles benötigen ca. 5 Minuten, um sich zu entladen.

Erden Sie sich nicht, und arbeiten Sie nicht in feuchter oder nasser Umgebung.

## SERVICESICHERHEIT

Notwendige Reparaturen können es erforderlich machen, den Gehäusedeckel während des Betriebes zu entfernen.

Reparaturen dürfen nur von qualifiziertem, eingewiesenem Personal ausgeführt werden.

“WARNING” im folgenden Text weist auf gefährliche Operationen hin, die zu Verletzungen oder zum Tod führen können.

“CAUTION” im folgenden Text weist auf Prozeduren hin, die genauestens befolgt werden müssen, um eventuelle Beschädigungen des Gerätes zu vermeiden.

# PRECAUTIONS IMPORTANTES POUR VOTRE SECURITE

## CONSIGNES DE SÉCURITÉ

CETTE ALIMENTATION GÉNÈRE DES TENSIONS QUI SONT DANGEUREUSES ET PEUVENT ÊTRE FATALES.  
SOYEZ EXTRÊMEMENT VIGILANTS LORSQUE VOUS UTILISEZ CET ÉQUIPEMENT.

Les alimentations haute tension doivent toujours être mises à la masse.

Ne touchez pas les connectiques sans que l'équipement soit éteint et que la capacité à la fois de la charge et de l'alimentation soient déchargées.

Prévoyez 5 minutes pour la décharge de la capacité interne de l'alimentation.

Ne vous mettez pas à la masse, ou ne travaillez pas sous conditions mouillées ou humides.

## CONSIGNES DE SÉCURITÉ EN CAS DE REPARATION

La maintenance peut nécessiter l'enlèvement du couvercle lorsque l'alimentation est encore allumée.

Les réparations doivent être effectuées par une personne qualifiée et connaissant les risques électriques.

Dans le manuel, les notes marquées « **WARNING** » attire l'attention sur les risques lors de la manipulation de ces équipements, qui peuvent entraîner de possibles blessures voire la mort.

Dans le manuel, les notes marquées « **CAUTION** » indiquent les procédures qui doivent être suivies afin d'éviter d'éventuels dommages sur l'équipement.

## IMPORTANTI PRECAUZIONI DI SICUREZZA

### SICUREZZA

QUESTO ALIMENTATORE GENERA TENSIONI CHE SONO PERICOLOSE E POTREBBERO ESSERE MORTALI.  
PONI ESTREMA CAUTELA QUANDO OPERI CON QUESTO APPARECCHIO.

- Gli alimentatori ad alta tensione devono sempre essere collegati ad un impianto di terra.
- Non toccare le connessioni a meno che l'apparecchio sia stato spento e la capacità interna del carico e dell'alimentatore stesso siano scariche.
- Attendere cinque minuti per permettere la scarica della capacità interna dell'alimentatore ad alta tensione.
- Non mettere a terra il proprio corpo oppure operare in ambienti bagnati o saturi d'umidità.

### SICUREZZA NELLA MANUTENZIONE.

- Manutenzione potrebbe essere richiesta, rimuovendo la copertura con apparecchio acceso.
- La manutenzione deve essere svolta da personale qualificato, coscio dei rischi elettrici.
- Attenzione alle **AVVERTENZE** contenute nel manuale, che richiamano all'attenzione ai rischi quando si opera con tali unità e che potrebbero causare possibili ferite o morte.
- Le note di **CAUTELA** contenute nel manuale, indicano le procedure da seguire per evitare possibili danni all'apparecchio.

# Table of Contents

	PAGE
<b>1. INTRODUCTION</b>	
1.1 Description of the UM8-40 Series .....	1
1.2 Standard Features.....	1
1.3 Remote Operating Features.....	1
1.4 Options.....	2
1.5 Interpreting the Model Number .....	2
<b>2. INSPECTION &amp; INSTALLATION</b>	
2.1 Initial Inspection .....	3
2.2 Mechanical Installation.....	3
2.3 Temperature Considerations .....	3
<b>3. OPERATING INSTRUCTIONS</b>	
3.1 Operation.....	5
3.2 Standard Features.....	6
<b>4. PRINCIPLES OF OPERATION</b>	
4.1 DC Input.....	9
4.2 Inverter .....	9
4.3 High Voltage Transformer .....	9
4.4 High Voltage Output Section.....	9
4.5 Control Circuitry .....	9
<b>5. OPTIONS</b>	
5.1 L Option – Legacy Interface.....	11
5.2 C Option – Fast Rise Time.....	11
5.3 T Option – Low Temperature Coefficient .....	11
5.4 M Option – Mu Metal Shield.....	12
5.5 S Option – RF Tight Shielded Can .....	12
5.6 E Option – Eared Mounting Plate.....	12
5.7 B Option – Terminal Block.....	12
5.8 X Numbered Units – Custom Options .....	12
<b>6. MAINTENANCE</b>	
6.1 Periodic Servicing.....	13
6.2 Performance Tests.....	13
6.3 High Voltage Dividers .....	13
<b>7. FACTORY SERVICE</b>	
7.1 Warranty Service .....	14
7.2 Factory Service Procedures.....	14
7.3 Shipping Instructions .....	14

## LIST OF FIGURES

Figure 1	Outline Dimensions .....	4
Figure 2	Grounding .....	7
Figure 3	Remote Programming with a Remote Voltage Source .....	7
Figure 4	Programming using the +5V Reference.....	8
Figure 5	Remote Voltage and Current Monitoring .....	8
Figure 6	Enable Input .....	8
Figure 7	Block Diagram .....	10

# Chapter 1

## INTRODUCTION

### 1.1 Description of the UM8-40 Series

Spellman's UM8-40 Series of printed circuit board mountable, high voltage modules offer a form, fit and function replacement for presently available commercially made units, while providing additional features and benefits. Utilizing proprietary power conversion technology these SMT based high voltage modules provide improved performance, reliability and easy system integration.



The UM8-40 is available in three power ranges of 4, 15 and 30 watts with output voltages spanning from 15kV to 40kV with fixed positive or negative polarities. Voltage & Current loops with automatic cross over control regulate the output into any load condition. The UM8-40 is a reliable and robust series that is arc and short circuit protected. The comprehensive standard interface provides interfacing flexibility and all UM8-40 units are CE and RoHS compliant.

### 1.2 Standard Features

The UM8-40 Series incorporates several standard features designed to optimize user satisfaction and safety:

- **Slow Start:** A 10 millisecond slow start time constant assures quick yet fully controllable risetime of the high voltage output.
- **Current Regulating Loop:** Current programmability allows the user to set where the unit will current limit, anywhere from 0 to 100% of maximum rated current.
- **0 to +4.64Vdc Programming Inputs:** Positive polarity, high impedance, ground referenced 0 to 4.64Vdc voltage programming inputs correspond to 0 to 100% rated voltage and current outputs.

- **0 to +4.64Vdc Monitor Outputs:** Positive polarity, low impedance, ground referenced 0 to 4.64Vdc voltage monitor outputs correspond to 0 to 100% rated output voltage and current.

- **Precision +5Vdc Reference Output:** A precision micro power band gap reference of +5Vdc,  $\pm 0.5\%$ , 25ppm/ $^{\circ}\text{C}$  with an output impedance of 475 $\Omega$  is provided to simplify remote programming of the power supply.

- **Arc and Short Circuit Protected:** Due to the fixed, high frequency conversion rate the UM8-40s output capacitance is small resulting in minimal stored energy. Through the use of generously rated surge limiting resistors and a fast acting current loop, all units are fully arc and short circuit protected.

### 1.3 Remote Operating Features

- **Enable Input:** The Enable Input allows the user to easily control the HV ON/HV OFF status of the power supply. HCMOS compatible signals A low (<1.5Vdc) enable input signal equals HV OFF, while a high (open or >3Vdc) enable signal equals HV ON.

#### **Warning!**

***The Enable Input should not be used as for protection against user injury or for a safety interlock function.***



### 1.4 Options

Several standard options are available to customize your UM for you application.

- L Option – Legacy Interface
- C Option – Fast Rise Time
- T Option – Low Temperature Coefficient



- M Option – Mu Metal Shield
- S Option – RF Tight Shielded Can
- E Option – Eared Mounting Plate
- X Numbered Units – Custom Options

## 1.5 Interpreting the Model Number

The power supplies model number describes its capabilities. Model numbers are configured as follows:

UM25P15/L/E where:

- UM** is the product series name
- 25** is the maximum output voltage in kV
- P** is the output polarity
- 15** is the output power in watts
- L** is the Legacy Interface
- E** is the Eared Mounting Plate

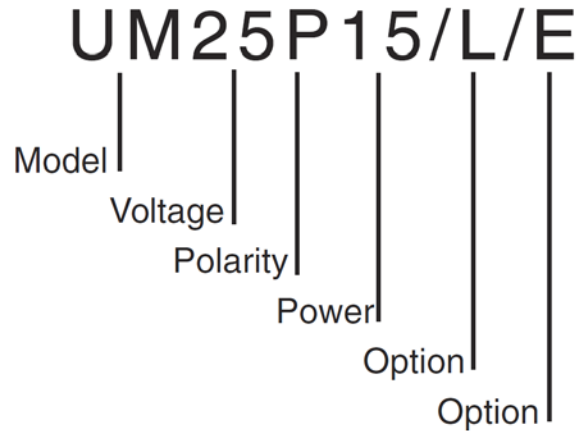

X numbered units are unique units custom developed for specific application requirements above and beyond the scope of the available standard options. Each 4 digit X number corresponds to an applicable specification control drawing.

# Chapter 2

## INSPECTION & INSTALLATION

Initial inspection and preliminary checkout procedures are recommended. For safe operation, please follow the procedures described in Chapter 3, Operating Instructions.

### 2.1 Initial Inspection

Inspect the packaging exterior for evidence of damage due to improper handling in transit. Notify the carrier and Spellman High Voltage immediately if damage is evident. Do not destroy or remove any of the packing material used in a damaged shipment.

After unpacking inspect the power supply for any visible signs of damage.

### 2.2 Mechanical Installation

Standard UM8-40 modules are intended for direct printed circuit board mounting, it is recommended that the unit be processed in a hand solder operation only.

Solder iron tip temperatures are most commonly between 315-371°C (600-700°F) for Sn63/Pb37 alloys and between 371-427°C (700-800°F) for Sn96.5/Ag3.0/Cu0.5 lead-free alloys.

Heat both the land area and component lead to be soldered with the iron prior to adding cored wire. Apply the solder wire to the land area or component lead. Do not apply the wire directly to the soldering iron tip. Do not apply solder iron to joint for a period exceeding 15 seconds.

Process and inspect workmanship to IPC-A-610 class 2 standards as applicable.

2-56 pan head stainless steel screws are provided to mechanically secure the unit to the printed circuit board assembly. Tighten the screws to 3 inch/pounds (0.34N•m) of torque.

Do not use longer screws than those provided, otherwise risk of damage to the unit is possible. The mounting screws are electrically isolated, they are not connected to any potential or ground point inside the power supply. Please see the UM8-40 data sheet for a more detailed dimensional drawing.

### 2.3 Temperature Consideration

Connection cooled typical. 30 Watt units operating at full power might require additional cooling to maintain case temperature below 65°C. Methods may include: Forced air cooling, use of a heat sink or metal case, etc. It is the user's responsibility to maintain the case temperature below 65°C. Damage to the power supply due to inadequate cooling is considered misuse and repairs will not be covered under warranty.

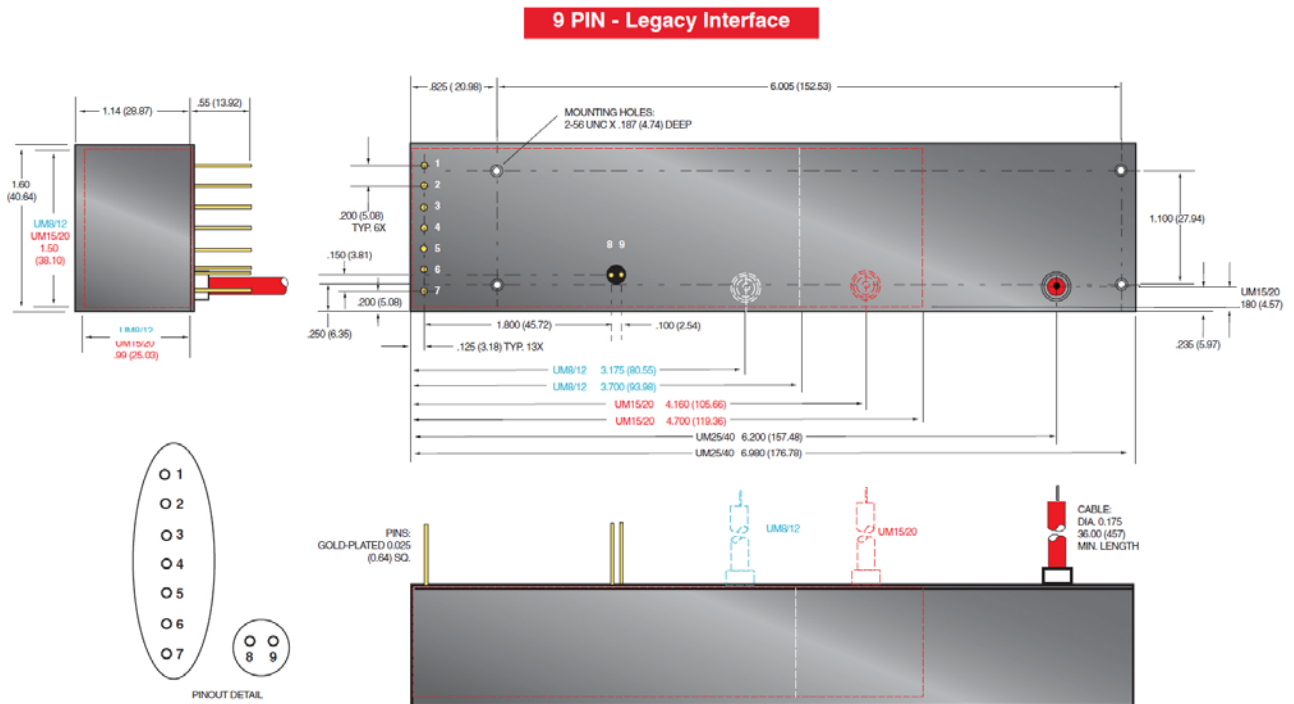
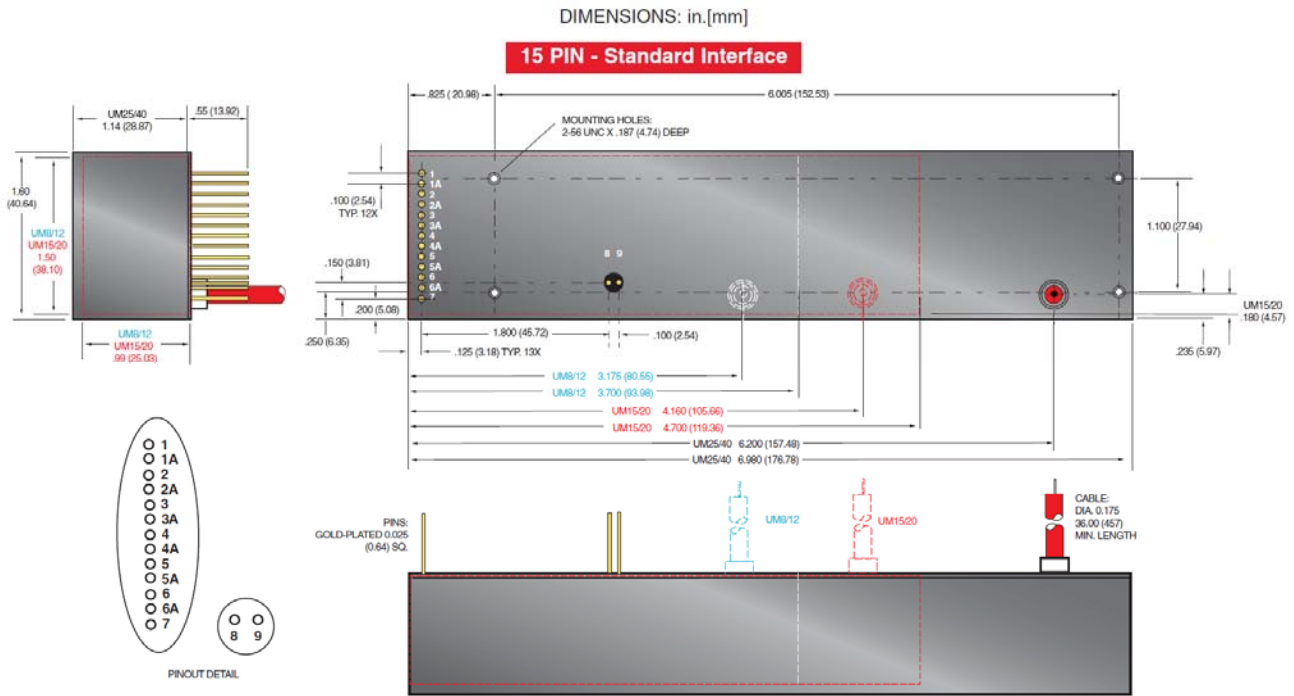

**Figure 1 Outline Dimensions**

# Chapter 3

## Operating Instructions

### 3.1 Operation

#### **WARNING!**

***This equipment generates dangerous voltages that may be fatal.***

***Proper grounding of all high voltage equipment is essential.***

***It is highly recommended that all testing comply with IEEE Standard 510-1983 IEEE***

***Recommended Practices for Safety in High Voltage and High Power Testing. A copy of this standard can be downloaded from the Spellman High Voltage website [here](#).***



#### **INPUT VOLTAGE**

Check the identification label on the power supply and confirm it matches the input voltage of the source supply that will be used to power the UM8-40 module. 4 watt units operate off +12Vdc, while 15 and 30 watt units operate off +24Vdc. If a 4 watt unit is connected to +24Vdc, the unit will operate properly meeting all specifications. If a 15 or 30 watt unit is connected to +12Vdc, no damage will occur but the unit may not perform properly.

#### **HIGH VOLTAGE CONNECTION**

Insure that high voltage connection is properly terminated to the load. Confirm that adequate air isolations spacings exist for the maximum voltage of the power supply, using the guideline of 10kV per inch (25.4mm) to any points that will be elevated to high voltage. All accessible high voltage points should be enclosed in a protective Faraday enclosure. Any access panels on the safety enclosure should be interlocked.

UM8-40 MANUAL

#### **GROUNDING**

Proper grounding of the unit is essential for reliable operation. Power Ground, Signal Ground and HV Ground Return are connected internally. For best performance they should not be connected externally.

The Power Ground connection (Pin 1) carries the +12Vdc or +24Vdc current that powers the unit, make this connection adequate enough to handle 2 amps, minimum. Additionally it is recommended that this connection be used to tie the power supply to whatever potential is used as the local “system ground”.

Signal grounds relating to programming and monitor functions should be referenced to the UM8-40’s Signal Ground (Pin5).

A physical load return connection must be made from the bottom of the load to the power supplies HV Ground Return (Pin 8).

See Figure 2 for details.

#### **OPTIONS**

See Section 5 of this manual for setup and operating instructions if the unit under test has any options. Custom X numbers units may also require special test requirements; consult the unit’s specification control drawing for details.

#### **SIGNAL CONNECTIONS**

Connect the appropriate programming and monitoring signals to the unit as detailed in the figures in this chapter.

#### **INITIAL TURN ON**

- A) Set the voltage and current programming inputs for zero output (Pin 6A and 5A respectively). Ground the Enable Input (Pin 4), to assure the unit is in HV OFF mode.
- B) The DC input power can now be connected.
- C) Enable the power supply by opening the Enable Input (Pin 4).

- D) Set the current programming level (Pin 5A) to just above the current anticipated that will be drawn from the power supply or leave open for preset current to 103% of rated current.
- E) Slowly increase the voltage programming (Pin 6A) while monitoring the voltage and current monitors (Pin 4A and 3A respectively). Carefully note proper equipment operation and that the load is behaving as predicted.
- F) To turn the HV OFF ground the Enable Input (Pin 4). If the equipment is to be left off for an extended period of time or service of the unit or load is required turn off the DC input power.

**Legacy Interface Units:**

Negative output polarity units are programmed such that 5.0Vdc to 0.36Vdc equals 0 to 100% of rated output voltage

**WARNING!**

***After turn off do not touch anything that has been connected to the output of the power supply. Wait a minimum of 5 minutes, and then discharge any remaining stored energy by connecting the high voltage output to ground. Failure to follow these safety warnings can result in injury or death.***



**3.2 Standard Features**

Programming and monitoring of the UM8-40 is accomplished via the use of conventional positive polarity, ground referenced signals. All signal inputs and outputs are noise filtered, impedance protected and diode clamped providing an easy to use, robust analog customer interface. Excellent results have been obtained via the use of standard engineering design guidelines like twisted pair, shielded cables, the prudent dressing of interface wiring away from possible noise sources, short cable runs and adhering to a well thought out and executed grounding topology.

**REMOTE PROGRAMMING**

The UM8-40's programming and monitor signals are based upon a universal, positive polarity, ground referenced signal such that 0 to 4.64Vdc corresponds to 0 to 100% rated output.

Programming can be accomplished via the use of an applicable customer provided ground referenced voltage source that meets the mentioned requirements. See Figure 3 for details.

If such a source is not available a precision +5Vdc reference is provided on Pin 7. A simple adjustable voltage divider can be created using this reference and an external potentiometer(s) which will provide full control of the voltage and current loops. See Figure 4 for details.

**REMOTE MONITORING**

The voltage and current monitor signals have adequate bandwidth capability to accurately represent the actual respective output within the dynamic limits of the power supply. See Figure 5 for details.

**ENABLE INPUT**

The enable input signal provides simple control of the ON/OFF functionality of the high voltage output. See Figure 6 for details.

**WARNING!**

***It is extremely dangerous to use this circuit to inhibit high voltage generation for the purpose of servicing or approaching any area considered unsafe during normal usage.***



### OT OUTPUT

The UM8-40 is protected with a thermostat that will disable the generation of high voltage if an internal temperature of  $\geq 65$  degree C is sensed. This latching circuit will require the removal and reapplication of the input power to clear the fault, along with the power supply case dropping below 55 degrees C.

(provided through a  $1k\Omega$  series resistance) to indicate the power supply has terminated the generation of high voltage due to an over temperature condition. If this OT fault condition exists most likely the unit requires additional cooling, see section 2.3 “Temperature Considerations” in this manual for additional details and recommendations.

An Over Temperature Output fault signal is provided on pin 2A. This signal will go high, sourcing +5Vdc @ 1mA

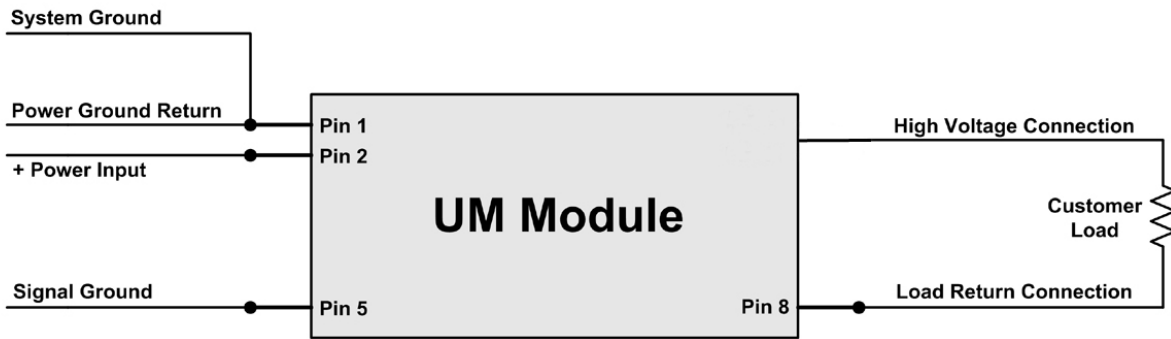

Figure 2 – Grounding

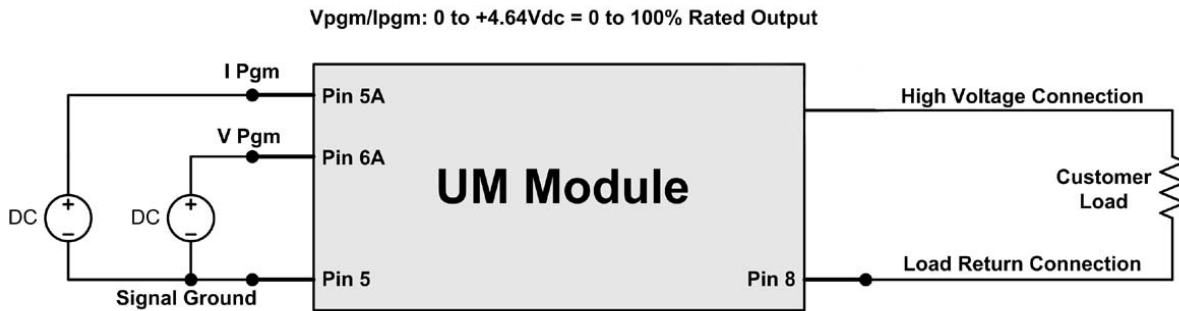
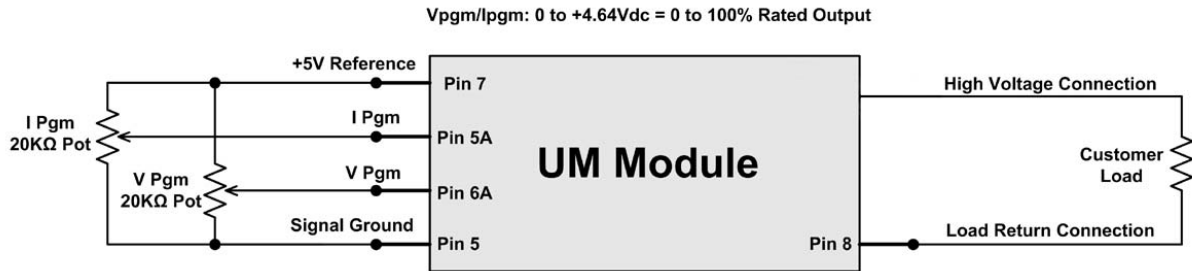

Figure 3 – Programming with a Remote Voltage Source



**Note:**  
 The +5V reference output (pin 7) is provided via an internal 475Ω inline series resistor for transient and short circuit protection. Take this impedance into account when selecting the resistance value of external programming potentiometers. Use 20K pots if both voltage and current adjustments are used as shown above. Use a 10K pot if only one pot is used and the other programming input is pulled up directly to +5V. The use of excessively low resistance values of programming potentiometers will create a significant voltage divider against the internal 475Ω series resistor resulting in the inability of programming the power supply to its maximum voltage and current outputs.

**Figure 4 – Programming using the +5V Reference**

Vmon/lmon: 0 to +4.64Vdc = 0 to 100% Rated Output

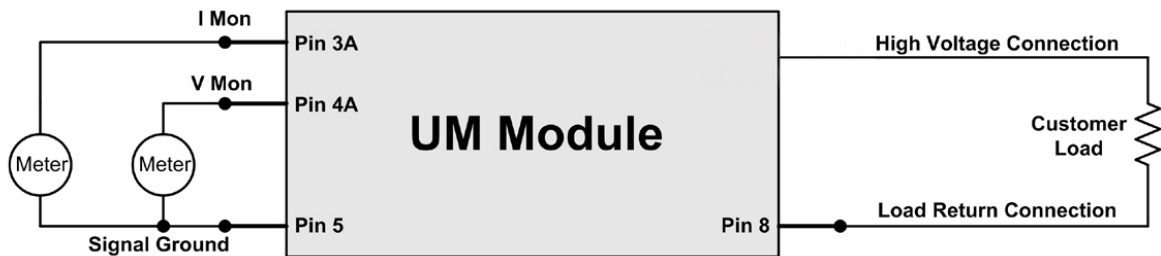

**Figure 5 – Remote Voltage and Current Monitoring**

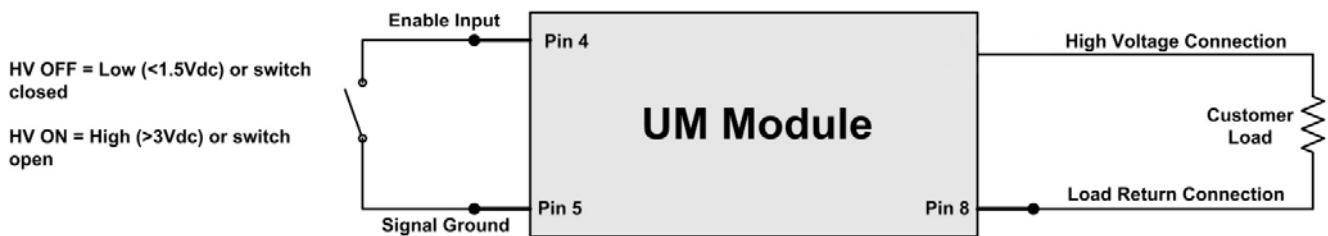

**Figure 6 – Enable Input**

**External Capacitance:**

For standard units (non C Option) placing large external capacitance on the output may result in operational instability. As a general rule of thumb, external capacitance should satisfy the equation:

$$C_{\text{external}} < 0.1 \text{ millisecond} / R_{\text{limit}}$$

where  $R_{\text{limit}}$  is the applicable arc limiting resistance specified in the UM8-40 selection table on page 2 of 6 of the UM8-40 data sheet.

For fast risetime units (C Option) no value of external capacitance will make the unit unstable.

# Chapter 4

## Principles of Operation

### Warning!

***The energy levels used and generated by the power supply can be lethal! Do not attempt to operate the power supply unless the user has a sufficient knowledge of the dangers and hazards of working with high voltage. Do not attempt to approach or touch and circuits that are connected to or have been connected to the power supply. Be certain to discharge any stored energy that may be present before and after the power supply is used. Consult IEEE recommended practices for safety in high voltage testing document number 510-1983.***



### 4.1 DC Input

The UM8-40 is a DC to DC converter. Within the power supply conversions from low voltage DC, to low voltage AC, to high voltage AC and finally to high voltage DC takes place. The DC input (either +12Vdc or +24Vdc) powers both the power conversion circuitry that creates the high voltage output, along with the low voltage DC housekeeping voltages that provide power to the affiliated support control circuitry.

### 4.2 Inverter

The DC input voltage is fed to the Inverter circuitry. Here the low voltage DC is converted to a low voltage, high frequency AC signal. This power conversion step allows for all subsequent power processing to take advantage of component miniaturization due to the high operational frequency. The Inverter functionality is controlled via the power supplies regulating loops which allows for complete command of the desired output voltage and current.

### 4.3 High Voltage Transformer

The high voltage transformer is a ferrite core step up type in which the primary is driven from the output of the Inverter circuit. The secondary of the high voltage transformer feeds the High Voltage Output Section.

### 4.4 High Voltage Output Section

The High Voltage Output Section utilizes an arrangement of half wave Cockcroft-Walton voltage multiplier stages to obtain the necessary output voltage.

The actual output voltage is sampled via a high impedance divider to create a voltage feedback signal. A current feedback signal is created via a current sense resistor in the low end return of the High Voltage Output Circuitry. These two accurate ground referenced feedback signals are used to precisely regulate and control the unit, in addition to providing external monitoring.

### 4.5 Control Circuitry

Various SMT based control circuitry is used for all interfacing, monitoring and regulation functionality of the UM8-40 modular power supply.

The voltage and current feedback signals generated in the High Voltage Output Section are compared to the requested voltage and current commands from the remote interface. The voltage or current loop error amplifier creates the appropriate error signal which is provided to the Pulse Width Modulation (PWM) circuitry.

The output of the PWM circuitry drives the Inverter circuit to provide the required output in a continuous closed loop control process, regulating in either voltage mode or current mode as required.



The internally generated voltage and current feedback signals are processed and provided to the remote interface for monitoring purposes.

A precision +5Vdc,  $\pm 0.5\%$ , 25ppm/ $^{\circ}\text{C}$  micro power band gap reference output is provided for user programming convenience.

The Enable Input from the remote interface controls the HV ON and HV OFF status of the power supply by interfacing with the PWM circuitry.

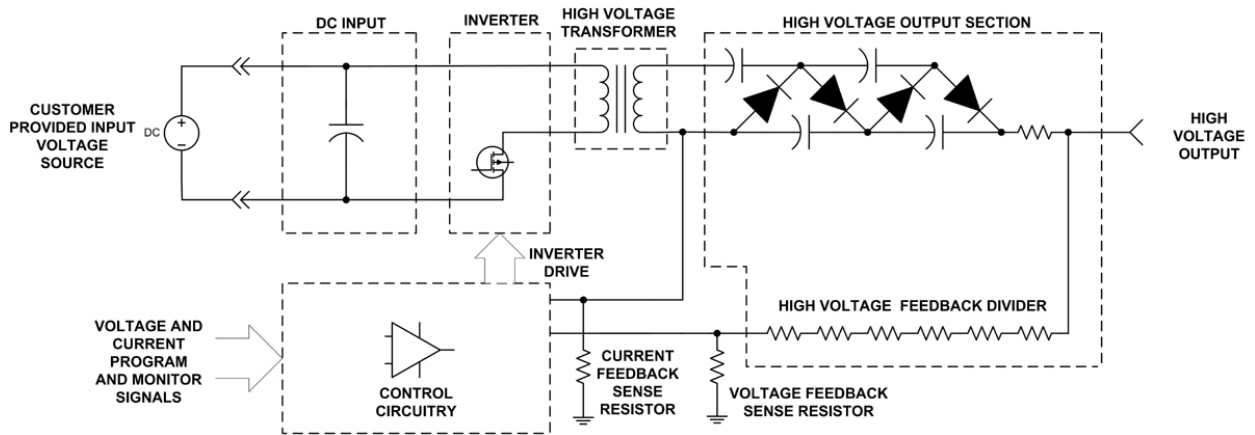
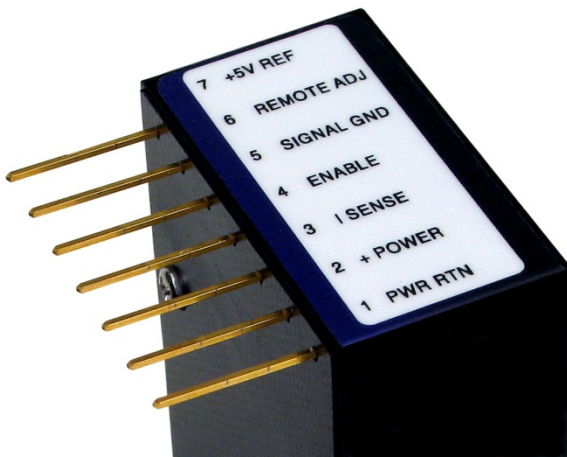

**Figure 7 - Block Diagram**

# Chapter 5

## OPTIONS

### 5.1 L Option - Legacy Interface



The Legacy Interface provides form, fit and function replacement for presently available commercially made units.

The standard UM8-40 is provided with a row of 13 interface pins on 0.1" center spacing. By removing "every other pin" the Legacy Interface provides 7 pins on 0.2" center spacing. Physically the UM8-40 with the Legacy Interface will fit into printed circuit boards designed for other commercially made units. A standard unit can be turned into a Legacy Interface unit by clipping the appropriate interface pins.

Functionality wise the Legacy Interface is electrically identical to other commercially made units so interface compliance is guaranteed.

### 5.2 C Option – Fast Rise Time

The C Option optimizes the UM8-40 for fast rise time/low overshoot requirements. A Hysteretic control circuit is employed providing improved performance. If used for capacitor charging, a Spellman Capacitor Charging Questionnaire should have been filled out to assure all aspects of the intended usage were reviewed assuring the appropriate unit was selected.

Typical rise times can be calculated using the following formula:

$$t_{RISETIME} = (V)(C + C_{EXT})/I$$

Where:

C = Output Capacitance of Unit  
C<sub>EXT</sub> = External Capacitance  
I = Nominal Output Current  
V = Maximum Rated Voltage

Where the minimum risetime shall never be less than 3ms.

Considering the maximum short circuit discharge rate is important in fast rise time applications. Energy is stored in the capacitance of the High Voltage Output Section of the unit. Output limiting resistors located inside the unit are electrically connected series with the output. These resistors limit the short circuit discharge current to a safe level. During short circuiting all the energy stored in the High Voltage Output Section is dissipated as heat in the output limiting resistors. If the repetitive short circuit discharge rate is too great the internal limiting resistors can get damaged due to thermal overload. Maximum short circuit discharge rates can be calculated as follows:

$$(CV^2)(f) < 1 \text{ watt}$$

Where:

C = Output Capacitance of Unit  
V = Rated Output Voltage of Unit  
f = Frequency of Discharge

### 5.3 T Option – Low Temperature Coefficient

The T Option offers the UM8-40 with an improved temperature coefficient. The standard voltage feedback divider is replaced with one having a superior temperature coefficient, resulting in a unit with 25ppm/C° (typical) temperature coefficient.

## 5.4 M Option – Mu Metal Shield



The M Option fits the UM8-40 with an adhesive backed Mu Metal foil shield to help protect sensitive adjacent circuitry. See data sheet for dimensional drawing.

## 5.5 S Option – RF Tight Shielded Can



The S Option mounts the UM8-40 module inside of a flanged RF tight aluminum can. See data sheet for dimensional drawing.

## 5.6 E Option – Eared Mounting Plate



An eared mounting plate is affixed to the top surface of the UM8-40 module allowing simple chassis mounting of unit. See data sheet for dimensional drawing.

## 5.7 B Option – Terminal Block



The B Option provides terminal block connections for the customer interface and high voltage return. Acceptable wires range from 20AWG to 26AWG. See data sheet for dimensional drawing.

## 5.8 X Numbered Units – Custom Options

When modification requirements of standard units are beyond the scope of standard options a custom unit is created. To accurately capture the details Spellman creates a unique Specification Control Drawing. This drawing outlines all items (mechanical, electrical, etc) that differ from a standard unit. These units will be designated as an X numbered unit. An X numbered unit will have an X number in its model number, like X1234. Together the UM8-40 data sheet and the applicable Specification Control Drawing will detail the parameters of these proprietary custom units.

# Chapter 6

## MAINTENANCE

**WARNING!**

***This power supply generates voltages that are dangerous and may be fatal.***

***Observe extreme caution when working with high voltage.***



### 6.1 Periodic Servicing

The UM8-40 product family does not require any periodic maintenance or servicing.

### 6.2 Performance Testing

**WARNING!**

***High Voltage is dangerous.  
Only qualified personnel should perform these tests.***

***It is highly recommended that all testing comply with IEEE Standard 510-1983 IEEE Recommended Practices for Safety in High Voltage and High Power Testing. A copy of this standard can be downloaded from the Spellman High Voltage website [here](#).***



Generalized high voltage test procedures are described in Bulletin STP-783, [Standard Test Procedures for High Voltage Power Supplies](#). A copy of this bulletin can be downloaded from the Spellman High Voltage website [here](#).

Test equipment includes, but is not limited to: an oscilloscope, a high impedance digital volt meter, a current meter, a ripple checker, a high voltage load, a high voltage divider (such as the Spellman HVD-100 or HVD-200) an insulated load stick and insulated short circuit stick and a safety interlocked Faraday test cage to safety conduct the tests inside of. All equipment must be properly rated for the power supply to be tested. If you do not possess the required equipment and skills necessary to safety conduct these tests do not attempt to perform these performance tests.

### 6.3 High Voltage Dividers

High voltage dividers for precise measurements of output voltage with accuracy up to 0.1% are available from Spellman. The HVD-100 is used for voltages up to 100KV, the HVD-200 measures up to 200KV.

The HVD Series of high voltage dividers are designed for use with differential voltmeters or high impedance digital voltmeters. The high input impedance of the HVD Series is ideal for measuring high voltage low current sources, which would be overloaded by traditional lower impedance dividers.

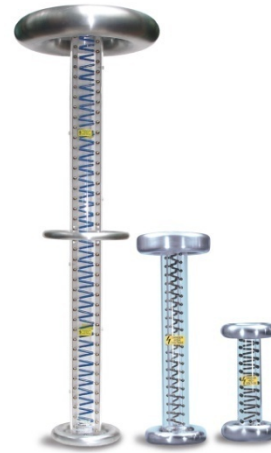

HVD Dividers

The HVD Series data sheet can be downloaded from the Spellman High Voltage website [here](#). Contact the Spellman Sales Department for information on price and availability.

# Chapter 7

## FACTORY SERVICE

### 7.1 Warranty Repairs

During the Warranty period, Spellman will repair all units free of charge. The Warranty is void if the unit is worked on by other than Spellman personnel. See the Warranty in the rear of this manual for more information. Follow the return procedures described in Section 7.2. The customer shall pay for shipping to and from Spellman.

### 7.2 Factory Service Procedures

Spellman has a well-equipped factory repair department. If a unit is returned to the factory for calibration or repair, a detailed description of the specific problem should be attached.

For all units returned for repair, please obtain an authorization to ship from the Customer Service Department, either by phone or mail prior to shipping. When you call, please state the model and serial numbers, which are on the plate on the rear of the power supply, and the purchase order number for the repair. A Return Material Authorization Code Number (RMA Number) is needed for all returns. This RMA Number should be marked clearly on the outside of the shipping container. Packages received without an RMA Number will be returned to the customer. The Customer shall pay for shipping to and from Spellman.

A preliminary estimate for repairs will be given by phone by Customer Service. A purchase order for this amount is requested upon issuance of the RMA Number. A more detailed estimate will be made when the power supply is received at the Spellman Repair Center. In the event that repair work is extensive, Spellman will call to seek additional authorization from your company before completing the repairs.

### 7.3 Shipping Instructions

All power supplies returned to Spellman must be sent shipping prepaid. Pack the units carefully and securely in a suitable container, preferably in the original container, if available. The power supply should be surrounded by at least four inches of shock absorbing material. Please return all associated materials, i.e. high voltage output cables, interconnection cables, etc., so that we can examine and test the entire system.

All correspondence and phone calls should be directed to:

**Spellman High Voltage Electronics Corp.**  
475 Wireless Boulevard  
Hauppauge, New York 11788  
TEL: (631) 630-3000  
FAX: (631) 435-1620  
E-Mail: [sales@Spellmanhv.com](mailto:sales@Spellmanhv.com)

To obtain information on Spellman's product warranty please visit our website at:

<http://www.spellmanhv.com/en/About/Warranty.aspx>

