

Keysight U9397A/C

FET Solid State Switches (SPDT)

U9397A 300 kHz to 8 GHz

U9397C 300 kHz to 18 GHz

Technical Overview

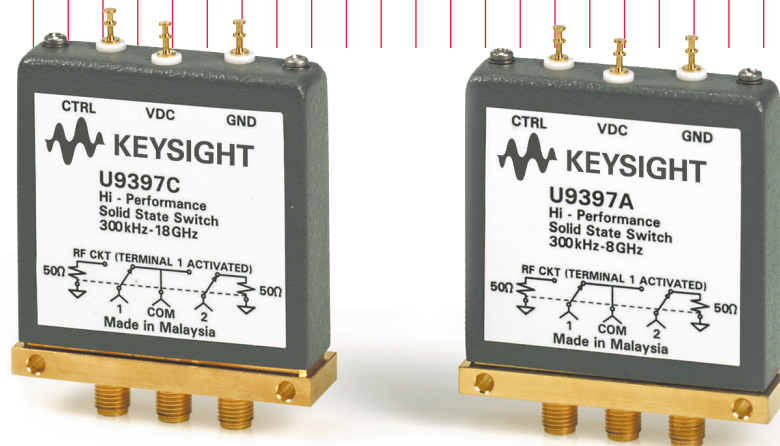

The Benefits of GaAs FET

GaAs FET switches have inherently low video leakage which makes them more suitable for measuring devices that require low maximum input power ratings. Sensitive components such as receivers, traveling wave tube (TWT) and handset power amplifiers typically have maximum input power ratings of < 13 dBm and can be easily damaged or over-driven by the high video leakage of PIN switches. Keysight Technologies, Inc. U9397A/C switches have < 10 mVpp video leakage compared to PIN switches which typically have 3 1 V video leakage.

GaAs FET switches have RF response extending down to DC, whereas in PIN switches there is a practical lower limit to the frequency range in which the diodes behave as linear resistors. Generally, PIN diode switches perform poorly below 10 MHz; the ON and OFF switching uses the same path as the RF, so they can not operate well at low frequencies.

Historically, the main drawback of GaAs FET switches has been a long settling time. The settling time of a switch is defined as 50% of TTL drive to 0.01 dB (99.88% Vfinal) of the final RF value as shown in Figure 1. Settling time includes: the time delay of the switch, switching speed and the time it takes to settle within 0.01 dB of its final value.

Typical GaAs FET switches have settling time in the order of tens of ms. This is mainly caused by the slow transients or the "gate lag" effect. Gate lag occurs when electrons become trapped at the surface of the GaAs device. The conventional method of reducing gate lag in GaAs devices is usually achieved by controlling the gate trough geometry so that the gates fit "tightly" in the bottom of trough. However, this approach reduces the breakdown voltage and power handling of the device. As shown in Figure 1, the typical transient behavior of FET switches from OFF state to ON state has a slow tail effect that increases the settling time.

Keysight U9397A/C FET switches patented design eliminates the gate lag effect (i.e. slow tail), resulting in a settling time of approximately 500 μ s.

Key Features

- Prevent damage to sensitive components with low video leakage < 10 mVpp
- Minimize crosstalk with exceptionally high isolation 100 dB @ 8 GHz
- Maintain fast throughput with settling time for FET switches of approximately 500 μ s
- Integrated TTL/CMOS driver eliminates the need for external drivers

Description

Keysight U9397A and U9397C FET solid state switches, SPDT provide superior performance in terms of video leakage, isolation, settling time and insertion loss across a broad operating frequency range. The U9397A/C are particularly suitable for measuring sensitive devices and components, such as mixers and amplifiers, where video leakage may cause damage or reliability issues. High isolation minimizes crosstalk between measurements, ensuring accurate testing and improving yields. A settling time of 500 μ s makes these ideal for high-speed RF and microwave SPDT switching applications in instrumentation, communications, radar, and many other test systems.

The U9397A/C incorporate a patented design which reduces the settling time to approximately 500 μ s (measured to 0.01 dB of the final value). Other FET switches available today have a typical settling time of > 50 ms.

The U9397A/C switches have a GaAs FET MMIC at each RF port, and the integrated TTL/CMOS driver is configured in such a way that when either the RF1 or RF2 port is not selected to RFCOM, the port is terminated to 50 Ohm.

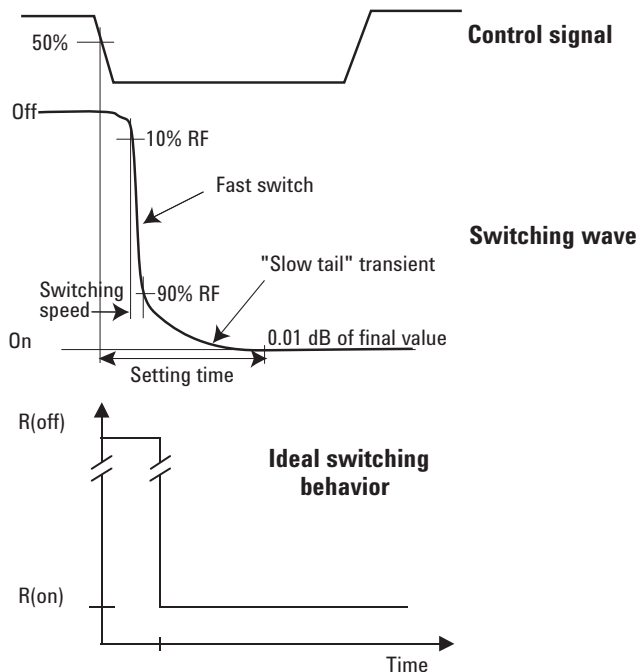
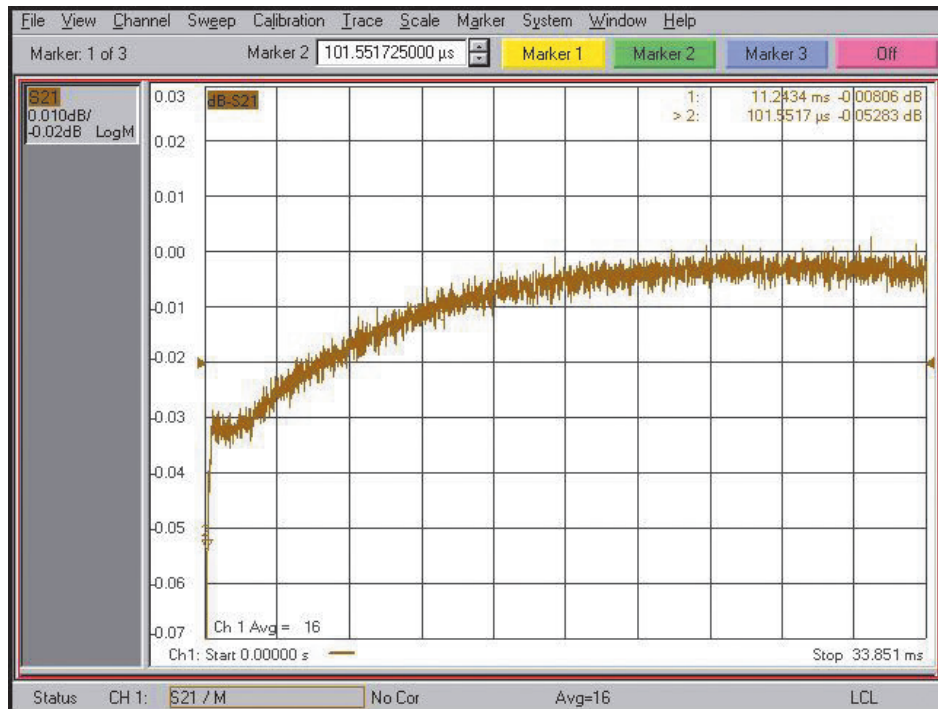
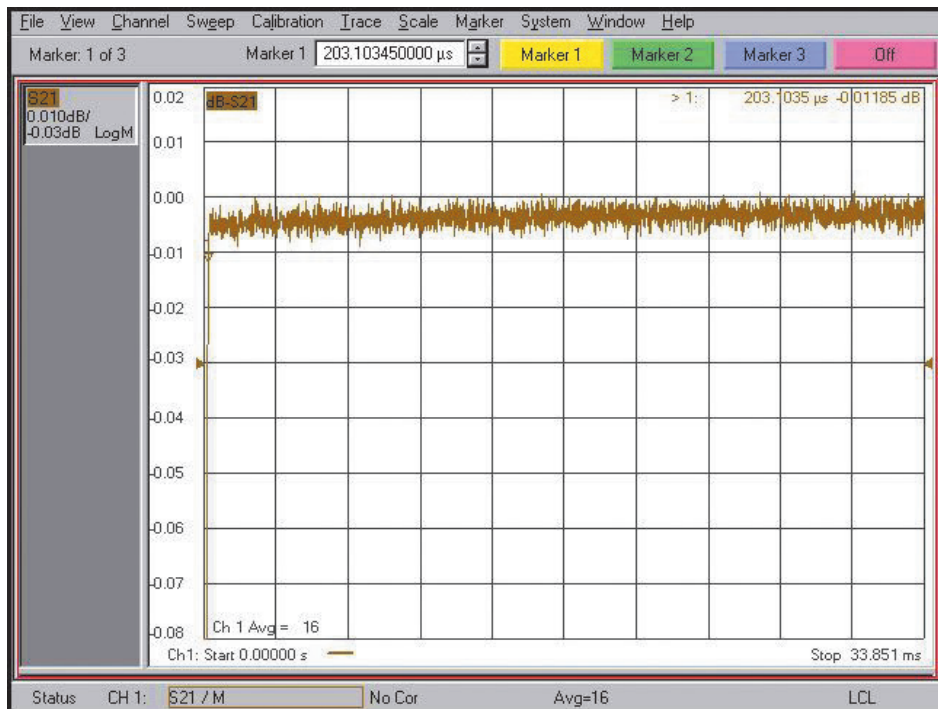

Figure 1. Comparison of ideal and real switching behavior



In Figure 2 the N5230A PNA-L network analyzer is used to measure the settling time of a typical FET switch. The trigger source is connected to the switch control pin and PNA-L external trigger to synchronize the measurement. Figure 2 shows the typical FET switch has very fast switching speed but very slow settling time. It takes about 11 ms to slowly settle from 0.03 dB to 0.01 dB. Keysight FET switches incorporate a patented technology that eliminates the slow settling time as shown in Figure 3. Settling time is very important for data acquisition systems because it is the primary factor that defines the data rate for a given error level. Hence, 0.01 dB settling time of the switch can be interpolated as 0.01 dB errors of the DUT measurement when the switch is being used in the measurement path.



A 0.01 dB settling time less than approximately 500 μ s makes these switches suitable for signal routing in EGSM/GSM power amplifier testing since each slot of a GSM signal is 577 μ s. This example will be explained in the Application section of this document.

Figure 3. Keysight FET switch transient behavior

Applications

Mixer measurements

Figure 4 shows a mixer test setup which is used to test two devices simultaneously. The LO signal is omitted in the diagram since it is a fixed LO. When the first device is being tested for s-parameters, the second device is being measured for harmonics or spurious signals. The high isolation of the switches plays an important role in achieving accurate measurements when measuring spurious signals as low as -120 dBm. In this test setup, the test signal of the first device-under-test (DUT) goes through switches “B” and “D” and appearing as spurious signals for the second DUT. The spurious signal can be as low as -120 dBm for second DUT, so the total isolation between each DUT must be greater than 140 dB. Hence, each switch needs to have at least 70 dB isolation to get accurate measurements.

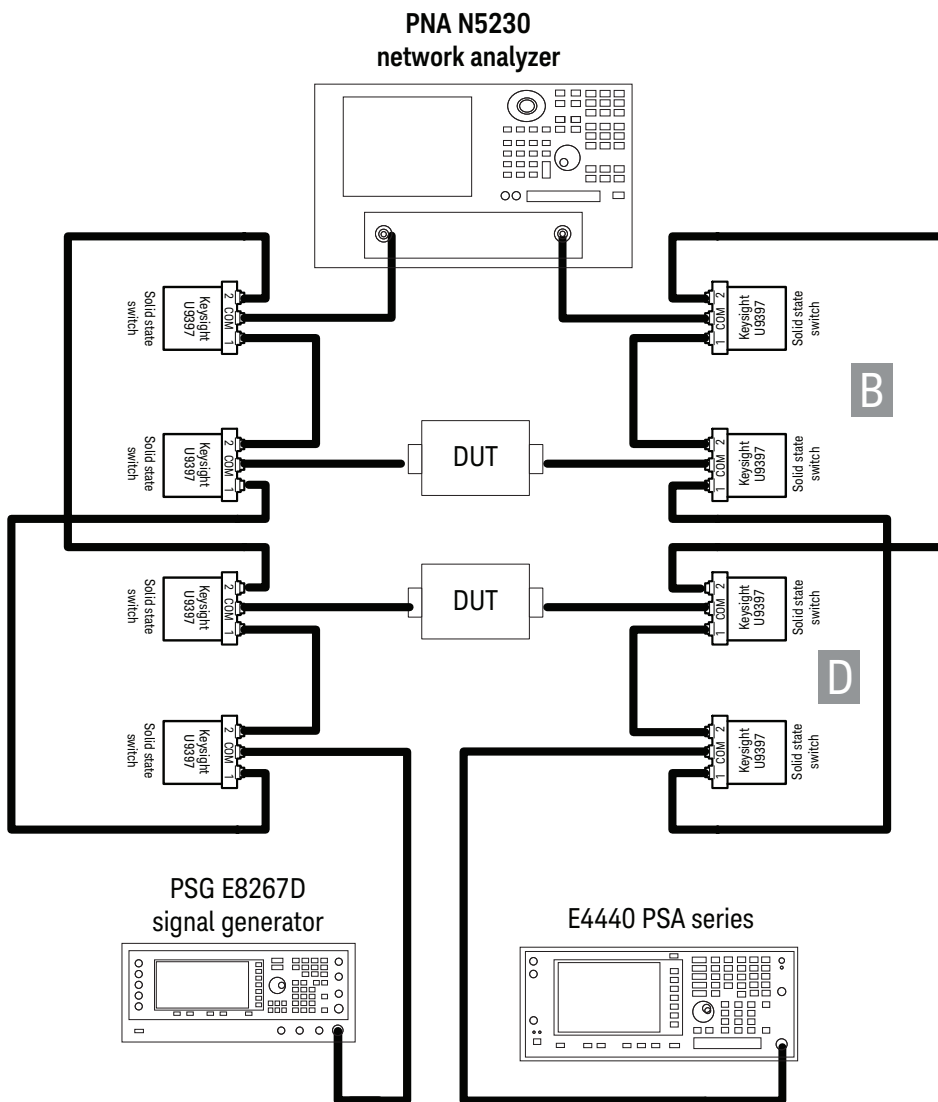

Figure 4. Mixer testing setup

Dual-band mobile handset power amplifier testing

Figure 5 shows a simplified test setup of a dual-band mobile handset power amplifier. A signal generator with digital modulation capability supplies the test signal to the power amplifier and a vector signal analyzer (VSA) is used to measure the output signal from the power amplifier. Two switches are used to switch between the DCS and GSM bands and two attenuators are placed at the output of the power amplifier to protect the switches. The triggering signal (frame trigger) from the signal generator is used to synchronize the VSA and trigger the switches to test the correct band of the power amplifier at the right time.

Switch selection is very important in this application for two reasons: First, the switch must have a settling time that is fast enough to allow the VSA to capture any timeframe of the of the Signal. Figure 6 shows a timing diagram for a GSM/EDGE signal, as you can see one slot equals 577 μ s. Thus, when the signal generator sends a frame trigger signal out, the switches must switch and settle within 577 μ s so the VSA can start to capture data within the time frame of the slot 1 signal to ensure accurate measurements. The second reason careful switch selection is needed is video leakage. Typical PIN switches have video leakage of 3 1V due to the nature of PIN switch design. This can potentially cause permanent damage to power amplifiers because their maximum input power is typically < 13 dBm. The other alternative, electro-mechanical switches, have low or no video leakage but the switching speed (typically in ms) is too slow for application.

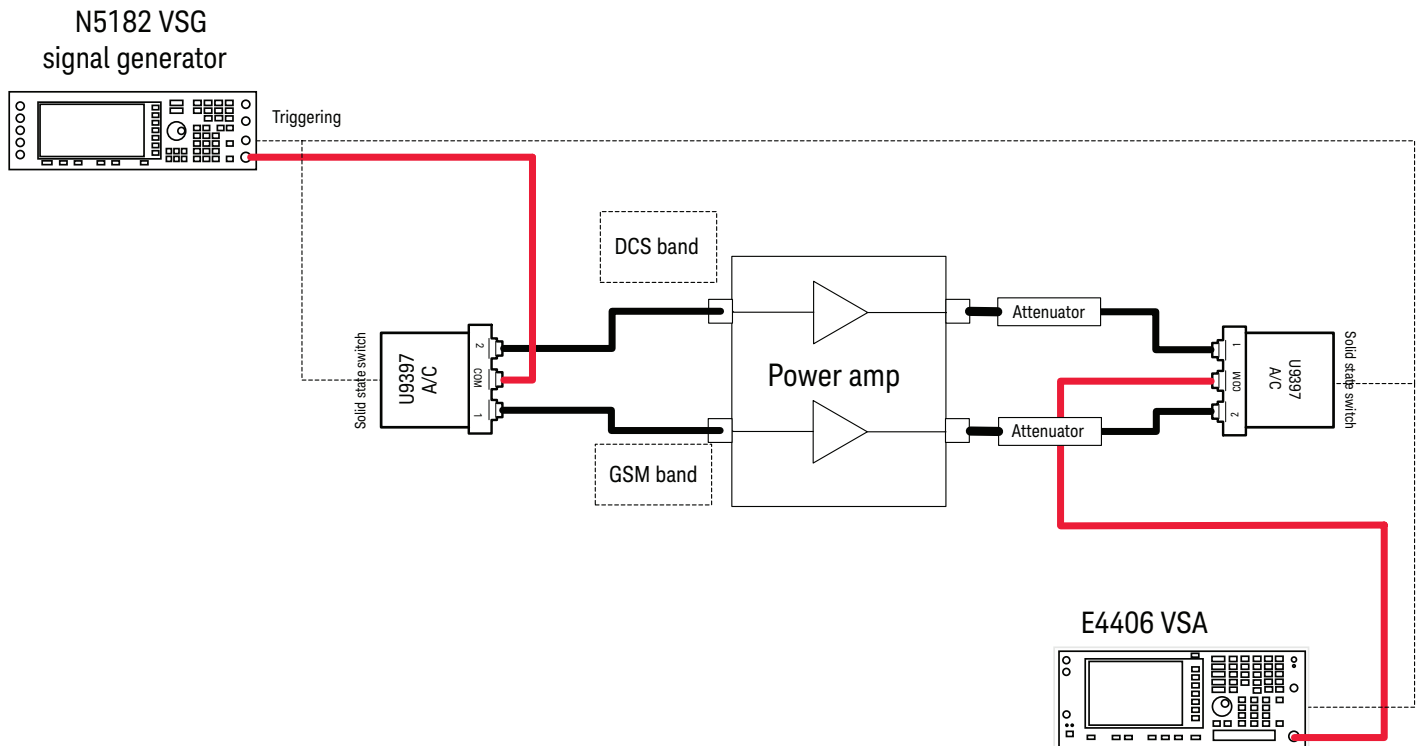

Figure 5. Simplified test setup for testing GSM/EDGE handset power amplifier

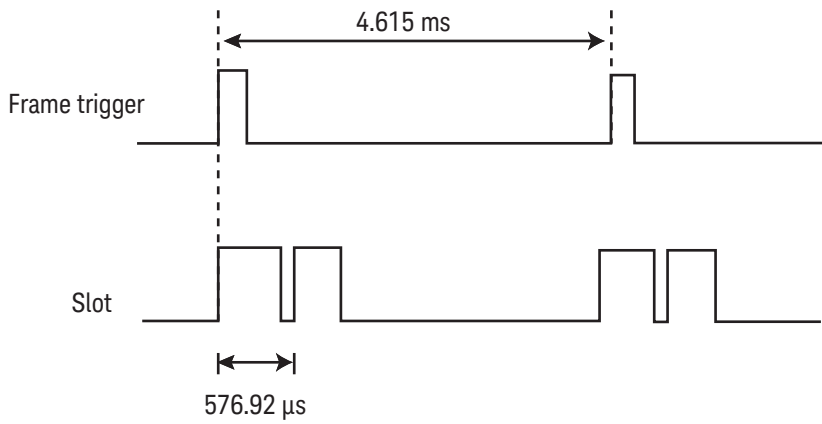

Figure 6. Timing diagram of a GSM/EDGE signal

Hence, U9397A/C is the most suitable switch for this application because of the low video leakage of < 10 mVpp and fast settling time of approximately $500 \mu\text{s}$. Because the typical spectrum analyzer smallest scale is only 0.1dB/div, the 0.01 dB settling time may be insufficient for certain applications. The typical 0.05 dB settling time of U9397A/C is approximately $250 \mu\text{s}$.

Specifications

Specifications refer to the performance standards or limits against which the solid state switches are tested.

Typical characteristics are included for additional information only and they are not specifications. These are denoted as “typical”, “nominal” or “approximate” and are printed in italic.

RF Specifications

Model	U9397A	U9397C
Frequency range	300 kHz to 8 GHz	300 kHz to 18 GHz
Insertion loss	< 3.0 dB (300 kHz to 4 GHz) < 3.5 dB (4 to 8 GHz)	< 5.0 dB (300 kHz to 8 GHz) < 6.5 dB (8 to 18 GHz)
Isolation	100 dB	90 dB
Return loss (ON & common port)	> 15 dB	> 10 dB
Return loss (OFF port)	> 18 dB	> 13 dB
Settling time	500 μ s (typical)	500 μ s (typical)
Switching speed rise/fall ¹	5 μ s (typical)	5 μ s (typical)
Video leakage	< 10 mVpp	< 10 mVpp
Characteristic impedance	50 Ω (nominal)	50 Ω (nominal)
Connectors	SMA (f)	SMA (f)

1. Switching speed is based on 10% to 90% RF.

Absolute Maximum Ratings¹

Parameters	U9397A		U9397C	
	Min	Max	Min	Max
RF input power (average)		+29 dBm		+27 dBm
DC voltage to RF port	-2.5 V	+2.5 V	-2.5 V	+2.5 V
Vdc bias	+12 V	+24 V	+12 V	+24 V
CTRL input high voltage	+2.4 V	5 V	+2.4 V	5 V
CTRL input low voltage	0 V	+0.8 V	0 V	+0.8 V

1. Operation in excess of any one of these specifications may result in permanent damage to the product.

2. Sinking not allowed.

Note: I_{DC} bias current is typically drawn of 47 mA

Environmental Specifications

The U9397A/C solid state switches are designed to fully comply with Keysight Technologies' product operating environment specifications. The following summarizes the environmental specifications for these products.

Temperature

Operating	-40 °C to +65 °C
Storage	-65 °C to +85 °C
Cycling	-65 °C to +150 °C, 10 cycles @ 20 °C per minute, 20 minutes dwell time per MIL-STD-833F, Method 1010.8, Condition C (modified)

Humidity

Operating	50% to 95% RH @ 40 °C, one 24 hour cycle, repeated 5 times
Storage	< 95% RH @ 40 °C, 5 days

Shock

Half-sine, smoothed	1000 G @ 0.5 ms, 3 shock pulses per orientation, 18 total per MIL-STD-833F, Method 2002.4, Condition B (modified)
---------------------	---

Vibration

Broadband, random	50 to 2000 Hz, 7.0 G rms, 15 minutes, per MIL-STD-833F, Method 2026-1 (modified)
-------------------	--

Altitude

Storage	< 15,300 meters (50,000 feet)
---------	-------------------------------

ESD immunity

Direct discharge ¹	4 kV per IEC 61000-4-2
Air discharge ²	8 kV per IEC 61000-4-2

1. To outer conductor

2. To center conductor

Mechanical Dimensions

	U9397A	U9397C
Length, mm (inches)	65.5 (2.58)	65.5 (2.58)
Width, mm (inches)	53.3 (2.1)	53.3 (2.1)
Net weight, kg (lb)	0.055 (0.121)	0.055 (0.121)

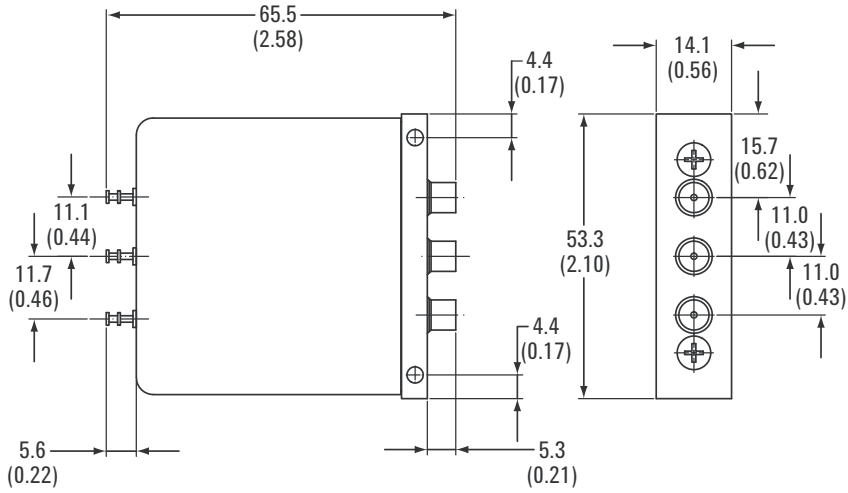

Figure 7. U9397A/C product outline

Typical Performance

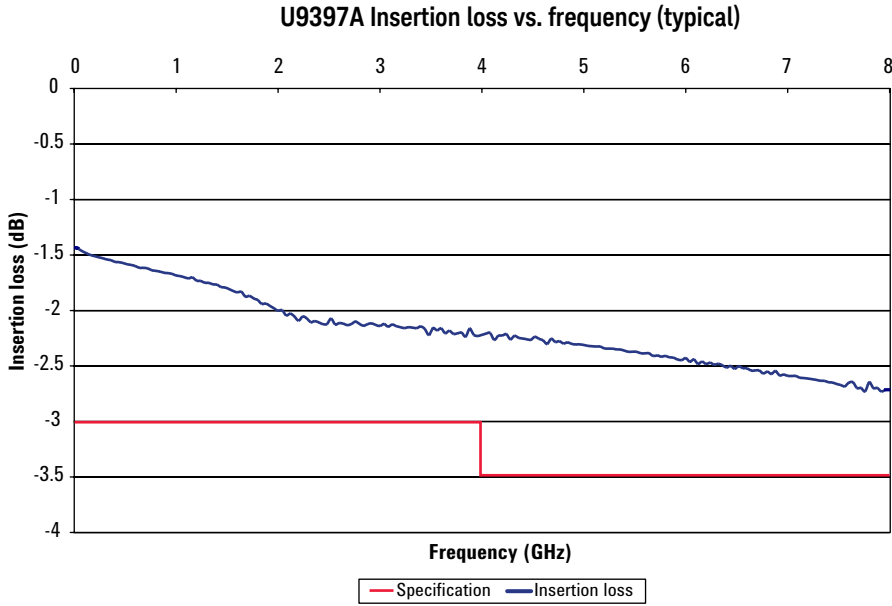

Figure 8. U9397A Insertion loss vs. frequency (typical)

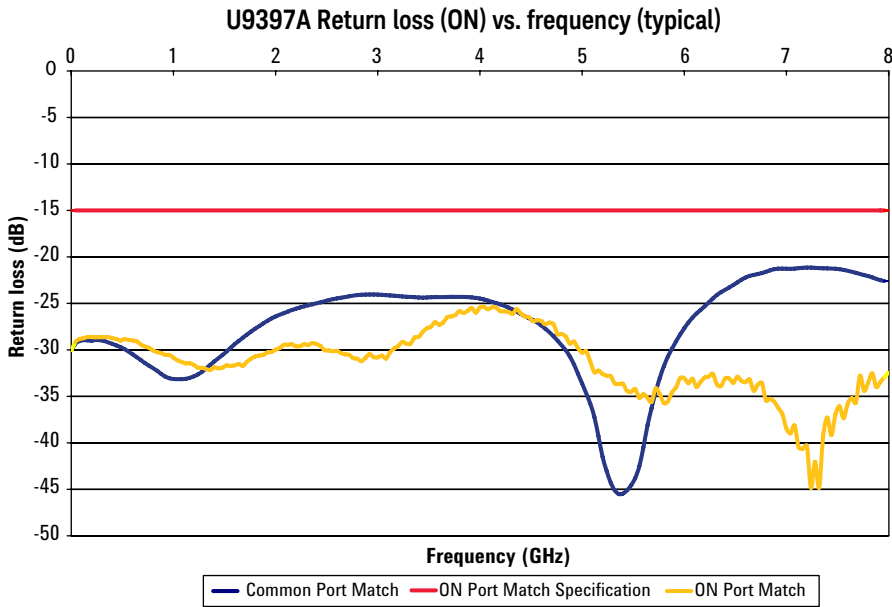

Figure 9. U9397A Return loss (ON) vs. frequency (typical)

Typical Performance

(continued)

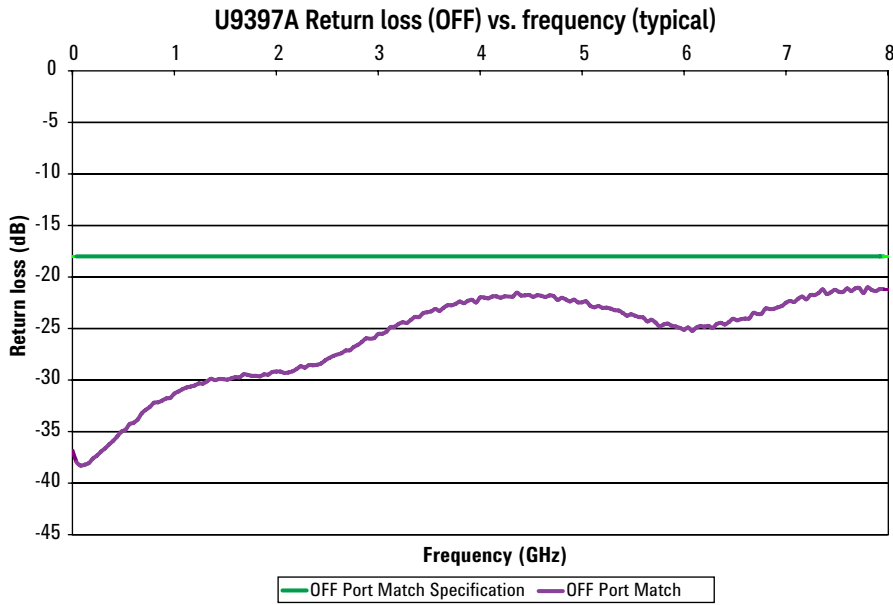

Figure 10. U9397A Return loss (OFF) vs. frequency (typical)

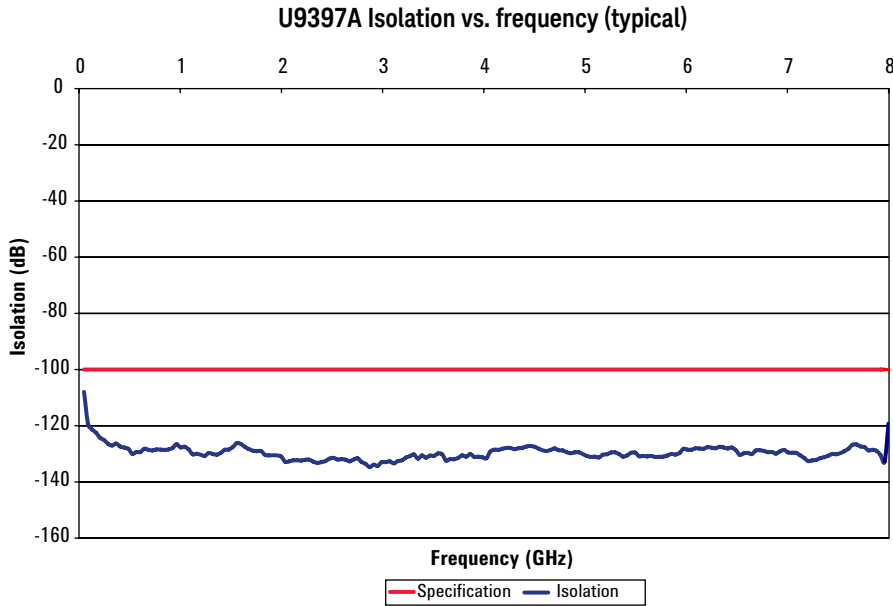

Figure 11. U9397A Isolation vs. frequency (typical)

Typical Performance

(continued)

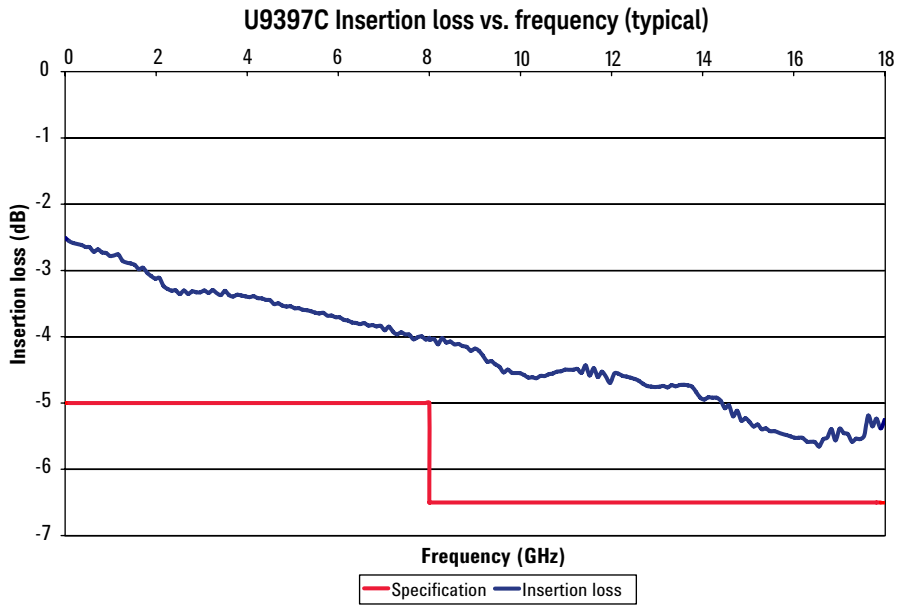

Figure 12. U9397C insertion loss vs. frequency (typical)

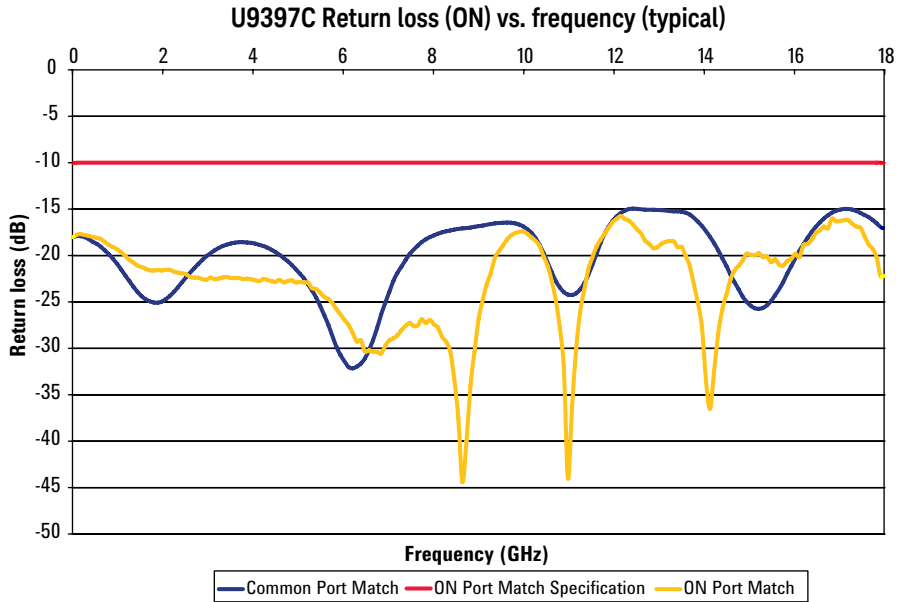

Figure 13. U9397C return loss (ON) vs. frequency (typical)

Typical Performance

(continued)

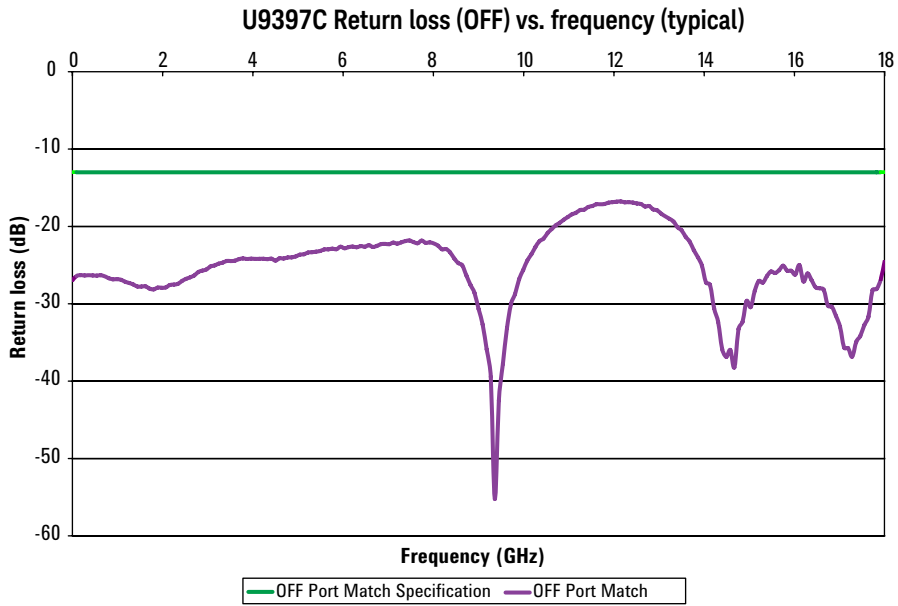

Figure 14. U9397C return loss (OFF) vs. frequency (typical)

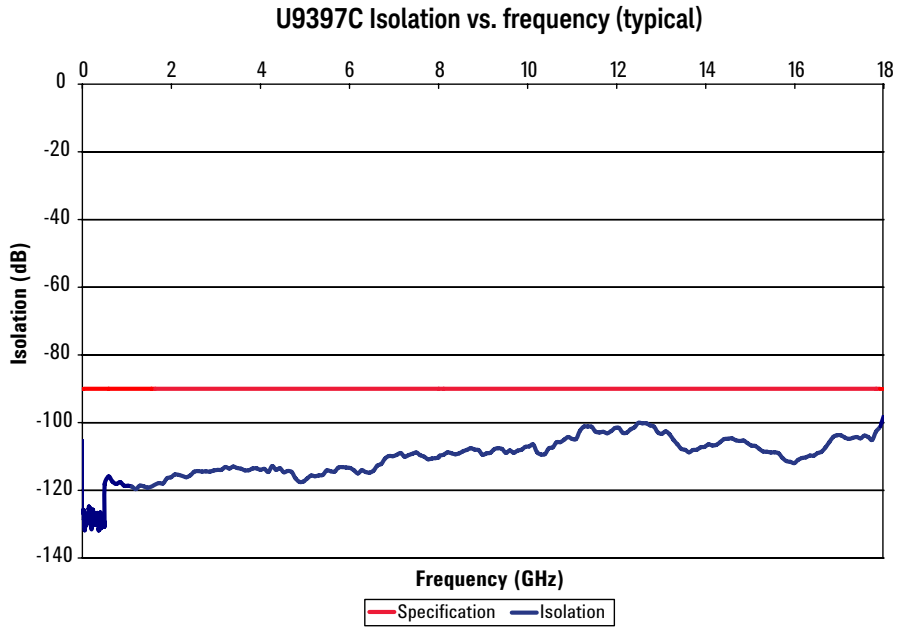

Figure 15. U9397C isolation vs. frequency (typical)

Ordering Information

U9397A	8GHz high performance solid state switch
U9397C	18 GHz high performance solid state switch

Related Literature

U9397A/C High Performance Solid State Switch Photo Card, 5989-6087EN

Video Leakage Application Note, 5989-6086EN

www.keysight.com/find/mta

Evolving Since 1939

Our unique combination of hardware, software, services, and people can help you reach your next breakthrough. We are unlocking the future of technology.
 From Hewlett-Packard to Agilent to Keysight.

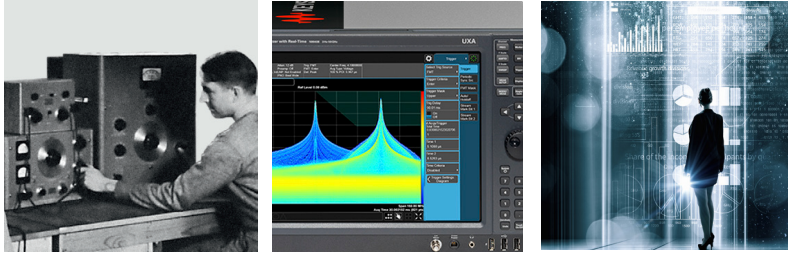

For more information on Keysight Technologies' products, applications or services, please contact your local Keysight office. The complete list is available at: www.keysight.com/find/contactus

Americas

Canada	(877) 894 4414
Brazil	55 11 3351 7010
Mexico	001 800 254 2440
United States	(800) 829 4444

Asia Pacific

Australia	1 800 629 485
China	800 810 0189
Hong Kong	800 938 693
India	1 800 11 2626
Japan	0120 (421) 345
Korea	080 769 0800
Malaysia	1 800 888 848
Singapore	1 800 375 8100
Taiwan	0800 047 866
Other AP Countries	(65) 6375 8100

Europe & Middle East

Austria	0800 001122
Belgium	0800 58580
Finland	0800 523252
France	0805 980333
Germany	0800 6270999
Ireland	1800 832700
Israel	1 809 343051
Italy	800 599100
Luxembourg	+32 800 58580
Netherlands	0800 0233200
Russia	8800 5009286
Spain	800 000154
Sweden	0200 882255
Switzerland	0800 805353
	Opt. 1 (DE)
	Opt. 2 (FR)
	Opt. 3 (IT)
United Kingdom	0800 0260637

For other unlisted countries:

www.keysight.com/find/contactus
 (BP-9-7-17)

DEKRA Certified
 ISO9001 Quality Management System

www.keysight.com/go/quality
 Keysight Technologies, Inc.
 DEKRA Certified ISO 9001:2015
 Quality Management System

This information is subject to change without notice.
 © Keysight Technologies, 2007 - 2014, 2017
 Published in USA, September 21, 2017
 5989-6088EN
www.keysight.com

myKeysight

myKeysight

www.keysight.com/find/mykeysight

A personalized view into the information most relevant to you.

http://www.keysight.com/find/emt_product_registration

Register your products to get up-to-date product information and find warranty information.

KEYSIGHT SERVICES
 Accelerate Technology Adoption.
 Lower costs.

Keysight Services

www.keysight.com/find/service

Keysight Services can help from acquisition to renewal across your instrument's lifecycle. Our comprehensive service offerings—one-stop calibration, repair, asset management, technology refresh, consulting, training and more—helps you improve product quality and lower costs.

Keysight Assurance Plans

www.keysight.com/find/AssurancePlans

Up to ten years of protection and no budgetary surprises to ensure your instruments are operating to specification, so you can rely on accurate measurements.



Keysight Channel Partners

www.keysight.com/find/channelpartners

Get the best of both worlds: Keysight's measurement expertise and product breadth, combined with channel partner convenience.

This data sheet contains a variety of typical and guaranteed performance data. This information supplied should not be interpreted as a complete list of circuit specifications. In this data sheet, the term typical refers to the 50th percentile performance. For additional information contact WPTC Marketing at 1-577-4211.

The product described in this data sheet is RoHS Compliant. See *RoHS Compliance* section for more details.

ATCA®, **AdvancedTCA®**, and the **ATCA logo** are registered US trademarks of the PCI Industrial Computer Manufacturers Group

www.keysight.com/find/mta

