

Keysight Technologies

# L Series L7222C Coaxial Transfer Switches

DC to 26.5 GHz

## Technical Overview



## High performance transfer switches for microwave and RF instrumentation and systems

- 0.03 dB insertion loss repeatability for 2 million cycles ensures accuracy and reduces calibration cycles
- Operating life of 5 million cycles typical
- Unmatched isolation maximizes measurement accuracy and improves system dynamic range
- Economical price minimizes budgetary constraints

Flexibility is essential in signal routing applications, and the Keysight Technologies, Inc. L7222C 4-port coaxial transfer switches offer just that. They provide exceptional repeatability, low insertion loss, and high isolation. These switches provide simplification of design in signal routing and conditioning applications.

The L7222C can be used in a variety of applications, such as switching two inputs and two outputs, signal reversal switching or as a drop-out switch. Innovative design and careful process control mean the L7222C meet the requirements for highly repeatable switching elements in test instruments and switching interfaces. They offer exceptional insertion loss repeatability, reducing sources of random errors in the measurement path and improving measurement uncertainty.

Switch life is a critical consideration in production test systems, satellite and antenna monitoring systems, and test instrumentation. The longevity of these switches increases system uptime and lowers the cost of ownership by reducing calibration cycles and switch maintenance.

Keysight L7222C transfer switches provide simplification of design in signal routing and conditioning applications with

- 0.03 dB insertion loss repeatability for 2 million cycles
- Excellent isolation, typically > 80 dB at 26.5 GHz
- Opto-electronic indicators and interrupts
- Magnetic latching
- TTL/5V CMOS compatible

### Description

Operating from DC to 26.5 GHz, these switches exhibit exceptional isolation performance required to maintain measurement integrity. Isolation between ports is typically > 90 dB to 12 GHz, > 80 dB to 26.5 GHz, reducing the influence of signals from other channels and system measurement uncertainties. Hence, the L7222C are ideal elements in large, multitiered switching systems.

The Keysight L7222C is designed to fall within most popular industry footprints. The 1¼ inch square flange provides tapped mounting holes, while the rest of the 2¾ inch long by 1¼ inch square body will easily fit into most systems. The standard 10-pin ribbon drive cable or optional solder terminal connections accommodate the need for secure and efficient control cable attachment.

Opto-electronic interrupts and indicators improve reliability and extend the life of the switch by eliminating DC circuit contact failures characteristic of conventional electromechanical switches. The L7222C have circuits that interrupt the current to all the solenoids once switching is complete and offer independent indicators that are controlled by optical interrupts. These indicators provide a closed path between the indicator common pin and the corresponding sense pin of the selected path.

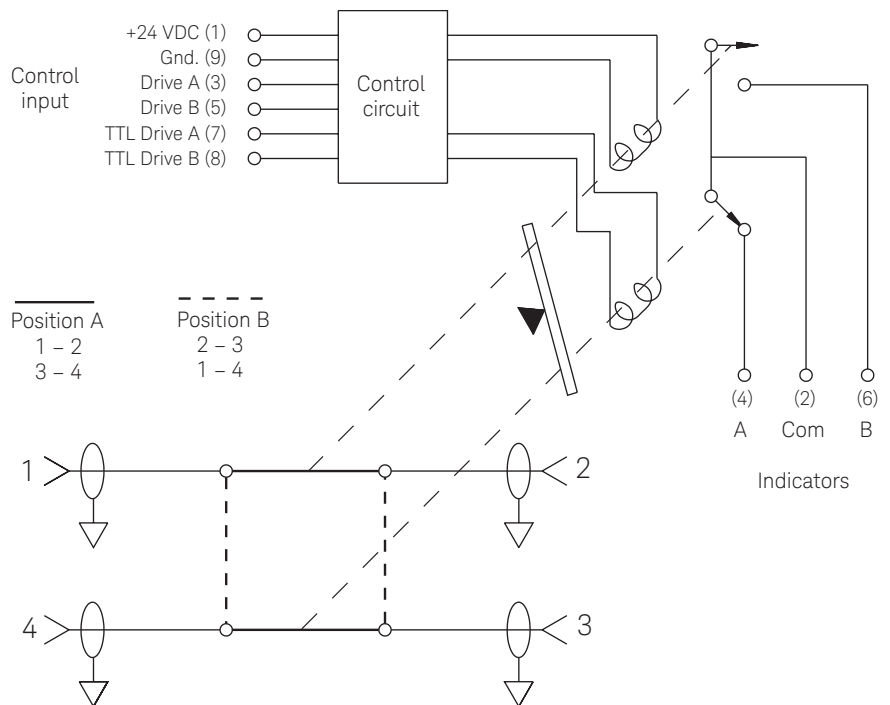

Figure 1. Keysight L7222C schematic

## Applications

The Keysight L7222C transfer switches can be used in many different applications to increase system flexibility and simplify system design. The following are five examples: switch between two inputs and two outputs, use as a drop-out switch, use for signal reversal, configure as a SPDT switch, and bypass an active device.

The L7222C transfer switches have the ability to exchange two signals between two inputs and two outputs. The transfer switch can connect two different instruments with two devices under test (DUT). Once switched, the signals are exchanged between the two instruments and the two DUTs. The exchanged signals allow complete network and spectrum analysis on two devices with a single switch and one test setup. See Figure 2 for an example of this application.

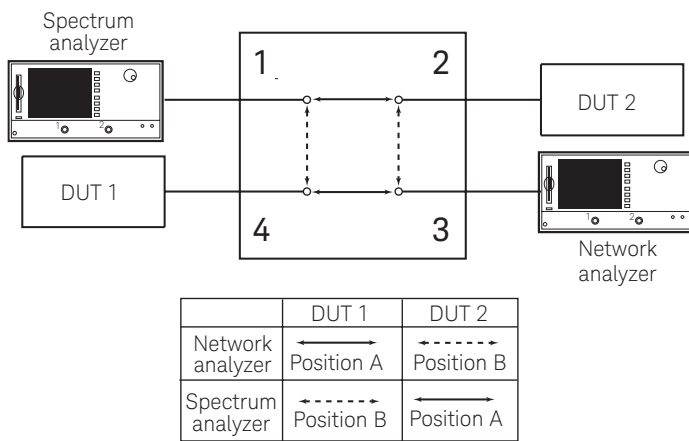

Figure 2. Switching two instruments and two DUTs

The L7222C can be used as a simple drop-out switch where a signal is either run through the device under test or straight through the switch, bypassing the device. See Figure 3.

In the signal reverse configuration, a device can be connected across two diagonal ports of the L7222C transfer switch. This will allow the signal direction through the device to be reversed. See Figure 4.

By attaching an external termination, the designer can use the L7222C in a SPDT terminated switch configuration. See Figure 5.

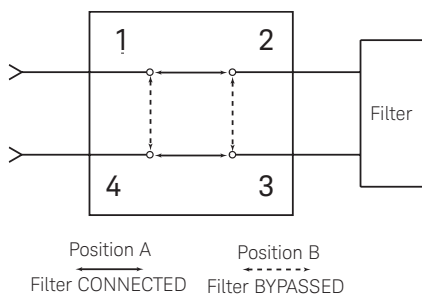

Figure 3. Drop-out switch

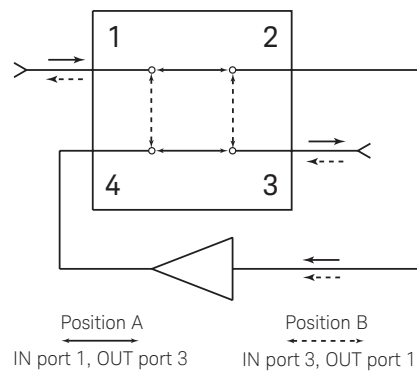

Figure 4. Signal reversal

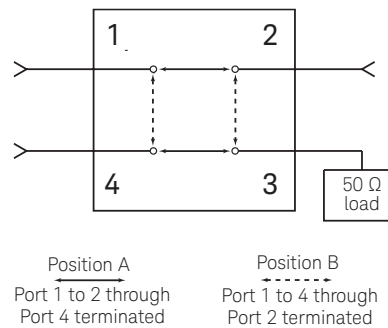

Figure 5. SPDT terminated

In Figure 6, an active device, such as an amplifier, is inserted into a signal path presenting a unique problem. A single transfer switch has the undesirable characteristic of shunting the output of the amplifier to its input when the signal is bypassing the amplifier. The advantage of using two transfer switches is that an additional signal path is available; however two SPDT switches can also be used. This additional path can utilize the same amplifier when the original path is bypassed.

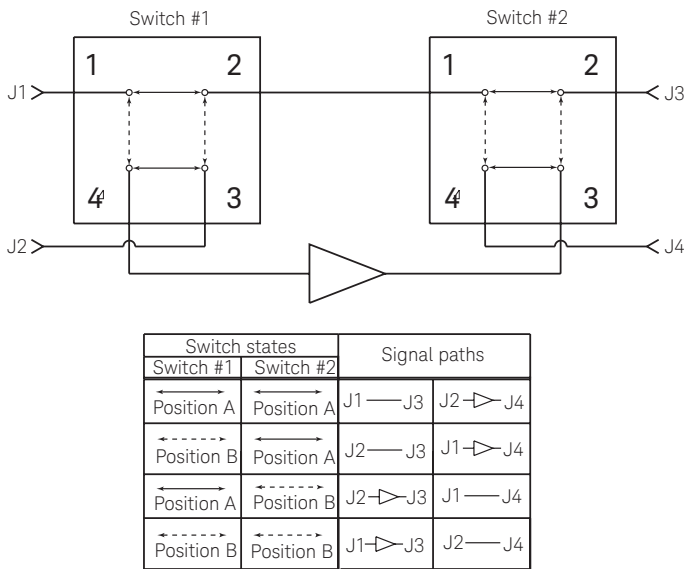

Figure 6. Bypassing an active device

## Driving the Switch

There are two positions for the L7222C transfer switches. See Table A. Position A has RF Port 1 connected to RF Port 2 and RF Port 3 connected to RF Port 4. Position B has RF Port 2 connected to RF Port 3 and RF Port 1 connected to RF Port 4. Either switch can be driven with a standard grounding drive control with or without a separate ground. Single line or dual line TTL control is also available. The switch operates in a break-before-make mode. See Figure 7.

### (I) Standard drive

See Figure 8 for drive connection diagrams.

- Connect pin 1 to supply (+20 VDC to +32 VDC).
- Connect pin 9 to ground (see Note 1).
- Select position A by applying ground to pin 3 (see Note 3).
- Select position B by applying ground to pin 5 (see Note 3).

### (II) Single line TTL drive

See Figure 8 for drive connection diagrams.

See Figure 9 for TTL voltage states.

- Connect pin 1 to supply (+20 VDC to +32 VDC).
- Connect pin 9 to ground (see Notes 2, 4).
- Connect pin 8 to TTL “High.”
- Select position A by applying TTL “High” to pin 7 (see Note 3).
- Select position B by applying TTL “Low” to pin 7 (see Note 3).

### (III) Dual line TTL drive

See Figure 8 for drive connection diagrams.

See Figure 9 for TTL voltage states.

- Connect pin 1 to supply (+20 VDC to +32 VDC).
- Connect pin 9 to ground (see Notes 2, 4).
- Select position A by applying TTL “High” to pin 7 and TTL “Low” to pin 8 (see Note 3).
- Select position B by applying TTL “Low” to pin 7 and TTL “High” to pin 8 (see Note 3).

#### Notes:

1. Pin 9 does not need to be grounded for the switch to operate in standard drive mode. If pin 9 is not grounded, the position indicators will only function while the appropriate drive has ground applied. Therefore, if a pulse drive is used and continuous indicator operation is required, pin 9 must be grounded.
2. For TTL drive, pin 9 must be grounded.
3. After the RF path is switched and latched, the drive current is interrupted by the electronic position-sensing circuitry. Pulsed control is not necessary, but if implemented, the pulse width must be 15 ms minimum to ensure that the switch is fully latched.
4. In addition to the quiescent current supplying the electronic position-sensing circuitry, the drive current flows out of pin 9 (during switching) when using TTL drive.

**CAUTION FOR USERS OF THE Keysight 11713B/C SWITCH DRIVER:** Do not drive the L7222C/D/E using the S9 or SO outputs from either the banana plugs or from pins 3 or 4 within the Atten X and Atten Y Viking sockets located on the rear panel of the 11713B/C.

Table A. Drive control alternatives

RF path	(I) Standard drive voltage		(II) Single line TTL/5V CMOS drive voltage		(III) Dual line TTL/5V CMOS drive voltage	
	Drive A	Drive B	TTL Drive A	TTL Drive B	TTL Drive A	TTL Drive B
	Pin 3	Pin 5	Pin 7	Pin 8	Pin 7	Pin 8
Position A 1 to 2, 3 to 4	Ground	Open	High	High	High	High
Position B 2 to 3, 1 to 4	Open	Ground	Low	High	Low	Low

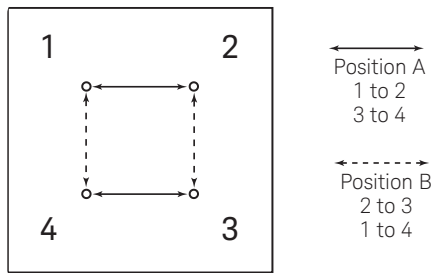

Figure 7. RF port connections

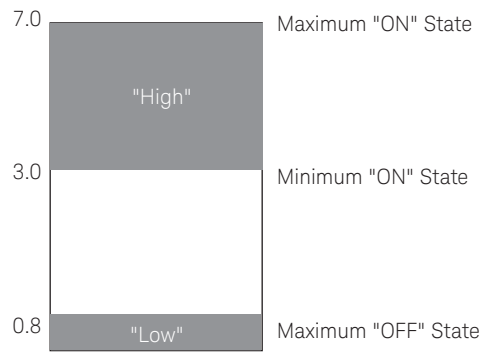
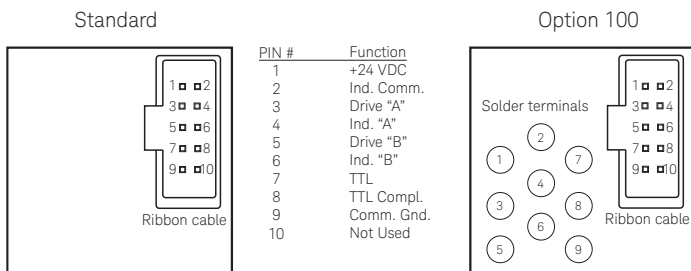

Figure 9. TTL control voltage states



Note:  
RF Port 1 is located directly behind the 10-pin ribbon cable connector.

Figure 8. Drive connections

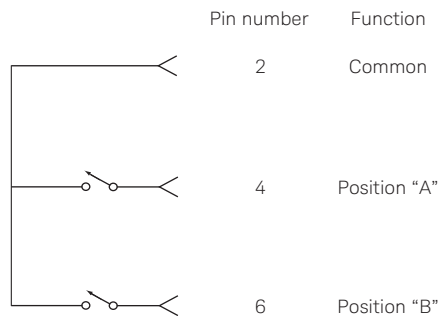

Figure 10. Indicator function diagram

## Electronic position indicators

The independent electronic position indicators consist of optically isolated, solid-state relays, which are driven by photo-electric sensors coupled to the mechanical position of the RF path's moving elements. See Figure 10. The circuitry consists of a common which can be connected to an output corresponding to either position A or position B. The solid state relays are configured for AC and/or DC operation. (See indicator specifications.) The electronic position indicators require that the supply (+20 VDC to +32 VDC) be connected to pin 1 but requires that pin 9 be grounded if pulse drive is used and continuous indicators operation is desired. If pin 9 is not grounded, the position indicators will function while the appropriate drive has ground applied.

## Specifications

Specifications describe the instrument's warranted performance. Supplemental and typical characteristics are intended to provide information useful in applying the instrument by giving typical, but not warranted performance parameters.

Table B. Standard switch drive specifications

Parameter	Conditions	Min	Nom	Max	Units
Supply voltage		20	24	32	V
Supply current, I <sub>cc</sub>	Switching: Pulse width > 15 ms: V <sub>cc</sub> = 24 VDC		200		mA
Supply current (quiescent)		25		50	mA

Table C. TTL Specific drive specifications

Parameter	Conditions	Min	Nom	Max	Units
High level input		3		7	V
Low level input				0.8	V
Max high input current	V <sub>cc</sub> = Max V input = 3.85 VDC		1	1.4	mA

## General Operating Data

Nominal/Impedance	50 $\Omega$
Maximum power rating	
Hot Switching	1 W CW 50 W peak, 10 us max pulse width, not to exceed 1 W average
Life	2,000,000 cycles minimum
Switching speed	15 ms maximum

### Indicator specifications

Maximum withstand voltage	60 V
Maximum current capacity	100 mA
Maximum "ON" resistance	50 $\Omega$
Maximum "OFF" resistance	1 G $\Omega$

### Environmental specifications

Operating temperature	-25 to 75 °C
Storage temperature	-55 to 85 °C
Temperature cycling	55 to 85 °C, 10 cycles per MIL-STD-202F, Method 107D, Condition A (modified)
Vibration	
Operating	7 g, 5 to 2000 Hz at 0.25 inches pk-pk
Survival	20 g, 20 to 2000 Hz at 0.06 inches pk-pk, 4 min/cycle, 4 cycles/axis
Random	2.41 g (rms) 10 min/axis
Shock	
Half-sine	500 g at 0.5 ms, 3 drops/direction, 18 total
Operating	50 g at 6 ms, 6 directions
Moisture resistance	65 °C, 95% RH, 10 days per MIL-STD-202F, Method 106E
Altitude storage	50,000 feet (15,240 meters per MIL-STD-202F)
RFI	Radiated Emission per CISPR

## Keysight L7222C

Frequency range	DC to 26.5 GHz
Insertion loss	0.2 dB + 0.025 x frequency (GHz)
Isolation	110 dB-2.0 x frequency (GHz)
SWR	1.1 maximum DC to 2 GHz 1.15 maximum 2 to 4 GHz 1.25 maximum 4 to 12.4 GHz 1.4 maximum 12.4 to 20 GHz 1.65 maximum 20 to 26.5 GHz
Insertion loss repeatability	< 0.03 dB typical
Connectors	SMA (f)

### Keysight L7222C physical specifications

Dimensions	Per Figure 13
Weight	100 gm (0.23 lb)

## Supplemental Characteristics

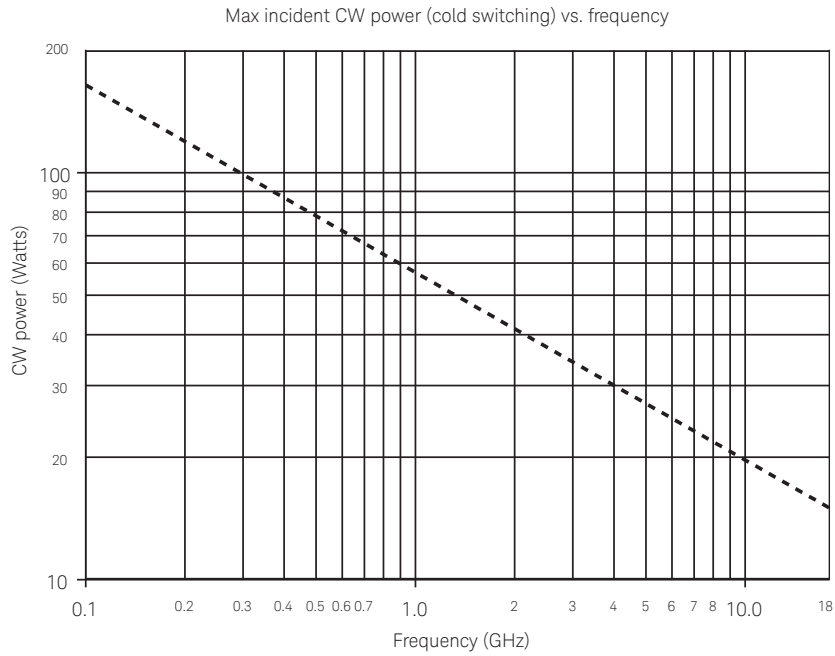

Figure 11. Maximum CW power for cold switching

### Reference conditions

- Cold switching only (NO Hot switching)
- Ambient temperature of 75 °C or less
- Sea level (0.88 derating @ 15,000 ft.)
- Load VSWR < 1.2 (see graph for derating above 1.2 VSWR)

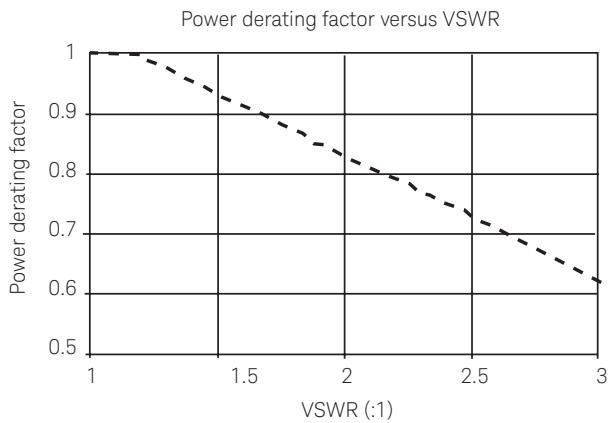

Figure 12. Power derating factor versus VSWR



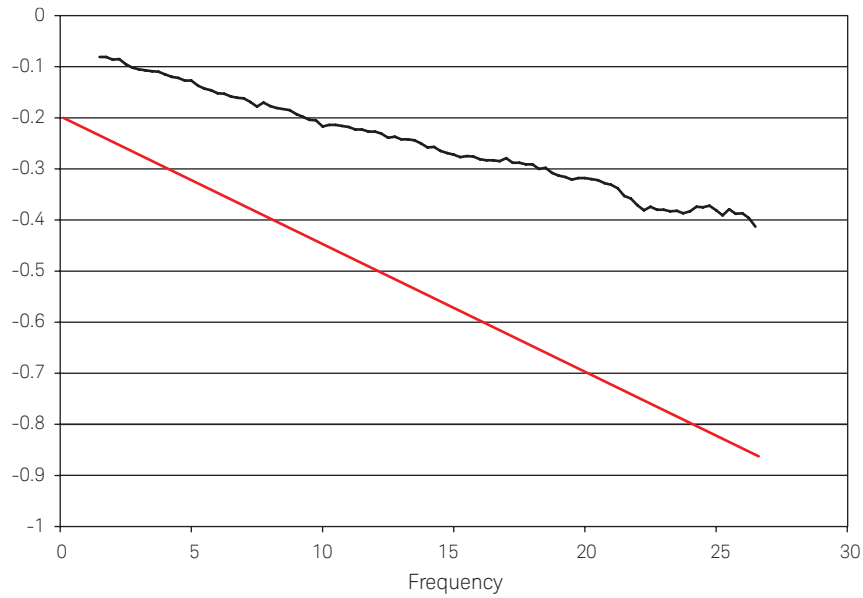

Figure 13. Keysight L7222C insertion loss versus frequency

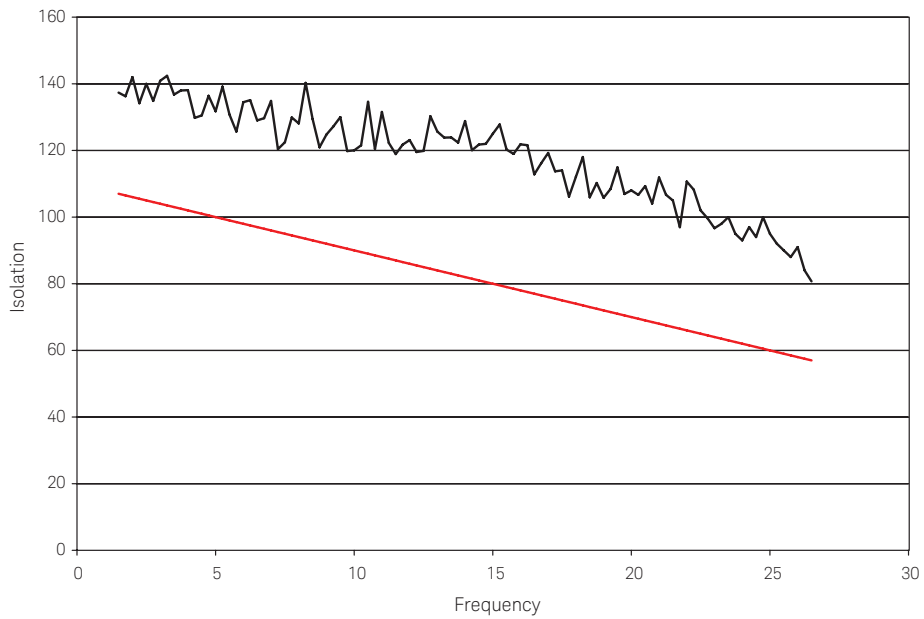

Figure 14. Keysight L7222C isolation versus frequency

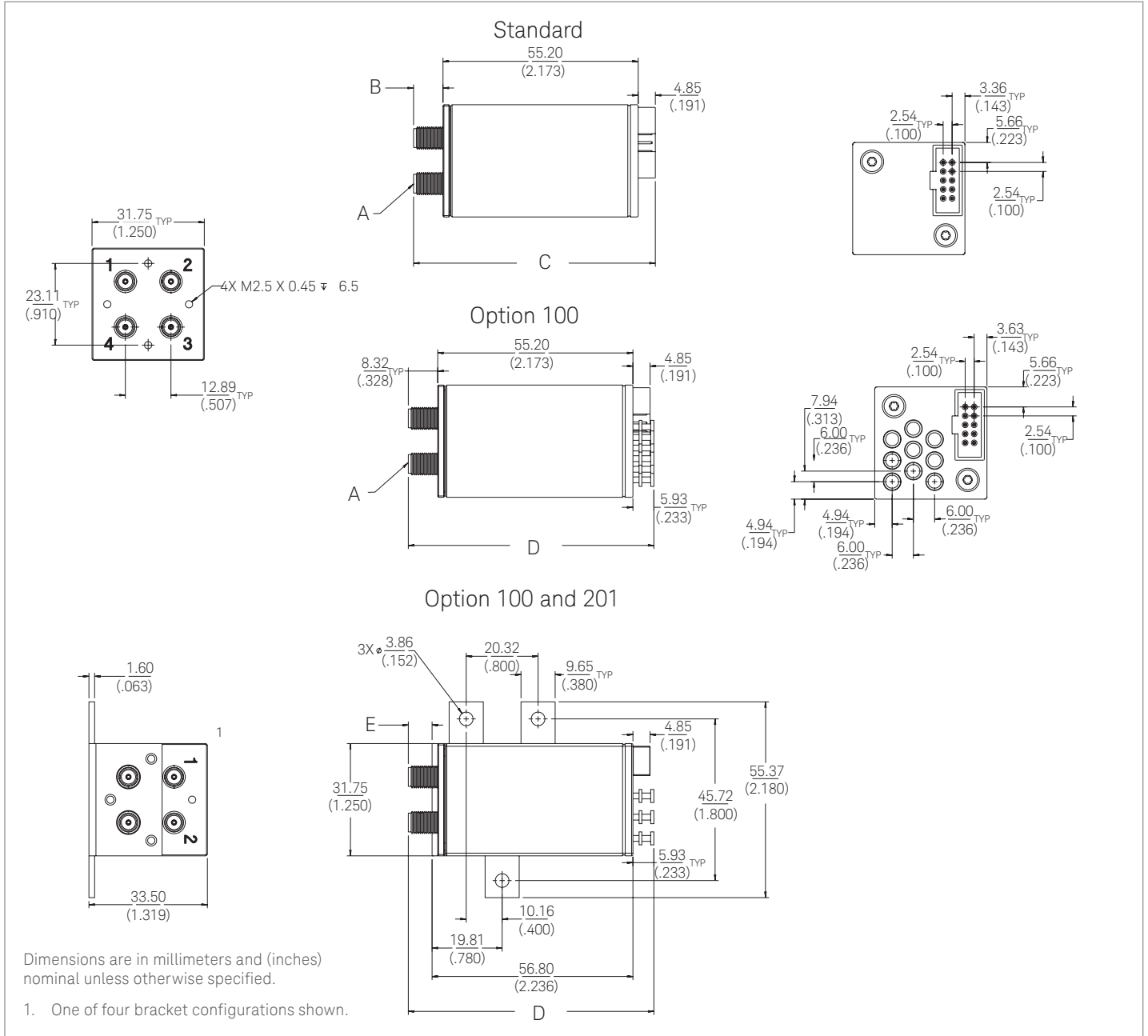

Figure 13. Product outlines

Keysight model number		A	B	C	D	E
L7222C	millimeter	8.32	68.37	69.46	6.72	
	(inches)	(.328)	(2.692)	(2.735)	(.265)	
		TYP	REF	REF	REF	

## Ordering Information

### Keysight coaxial transfer switch

- L7222C DC to 26.5 GHz
  - Option 100 Solder terminals in addition to ribbon cable
  - Option 201 Mounting bracket-assembly required
  - Option UK6 Commercial calibration test data with certificate

### Accessories available

- 87222-00003 Mounting bracket

### Keysight drivers

- 11713B/C attenuator switch driver
  - Drives up to 20 switches.

### Accessory cables

- 5061-0969 Viking connector to bare tinned wires (60 inches long). Use to connect 11713B/C to L7222C with Option 100. Will operate four L7222C switches.
- 11713-60047 Viking connector to (4) 10-pin DIP connectors. Will operate four L7222C switches using the 11713B/C driver.

## Related Literature

*Keysight Technologies Bench and System Switching Products*, Literature Number 5989-9872EN

*Keysight RF and Microwave Switch Selection Guide*, Literature Number 5989-6031EN

*Keysight 11713B/C Attenuator/Switch Drivers*, Configuration Guide, Literature Number 5989-7277EN

### Application Notes

*Power Handling Capability of Electromechanical Switches*, Literature Number 5989-6032EN

*How Operating Life and Repeatability of Keysight's Electromechanical Switches Minimize System Uncertainty*, Literature Number 5989-6085EN

**myKeysight**

**myKeysight**

[www.keysight.com/find/mykeysight](http://www.keysight.com/find/mykeysight)

A personalized view into the information most relevant to you.



[www.keysight.com/go/quality](http://www.keysight.com/go/quality)

Keysight Technologies, Inc.

DEKRA Certified ISO 9001:2008

Quality Management System

**Keysight Infoline**

[www.keysight.com/find/service](http://www.keysight.com/find/service)

**Keysight Infoline**

Keysight's insight to best in class information management. Free access to your Keysight equipment company reports and e-library.

**Keysight Channel Partners**

[www.keysight.com/find/channelpartners](http://www.keysight.com/find/channelpartners)

Get the best of both worlds: Keysight's measurement expertise and product breadth, combined with channel partner convenience.

[www.keysight.com/find/mta](http://www.keysight.com/find/mta)

For more information on Keysight Technologies' products, applications or services, please contact your local Keysight office. The complete list is available at: [www.keysight.com/find/contactus](http://www.keysight.com/find/contactus)

**Americas**

Canada	(877) 894 4414
Brazil	55 11 3351 7010
Mexico	001 800 254 2440
United States	(800) 829 4444

**Asia Pacific**

Australia	1 800 629 485
China	800 810 0189
Hong Kong	800 938 693
India	1 800 11 2626
Japan	0120 (421) 345
Korea	080 769 0800
Malaysia	1 800 888 848
Singapore	1 800 375 8100
Taiwan	0800 047 866
Other AP Countries	(65) 6375 8100

**Europe & Middle East**

Austria	0800 001122
Belgium	0800 58580
Finland	0800 523252
France	0805 980333
Germany	0800 6270999
Ireland	1800 832700
Israel	1 809 343051
Italy	800 599100
Luxembourg	+32 800 58580
Netherlands	0800 0233200
Russia	8800 5009286
Spain	800 000154
Sweden	0200 882255
Switzerland	0800 805353
	Opt. 1 (DE)
	Opt. 2 (FR)
	Opt. 3 (IT)
United Kingdom	0800 0260637

For other unlisted countries:  
[www.keysight.com/find/contactus](http://www.keysight.com/find/contactus)  
 (BP-04-23-15)