



Sigma 6-16HS

from serial no. 145876



Laboratory Centrifuge
with Heating System

Operating Manual

Please retain for later use!

© Copyright by
Sigma Laborzentrifugen GmbH
An der Unteren Söse 50
37520 Osterode am Harz
Germany

Tel.: +49 (0) 5522 / 5007-0
Fax: +49 (0) 5522 / 5007-12
Web: www.sigma-zentrifugen.de
E-mail: info@sigma-zentrifugen.de

Table of contents

1	General information	9
1.1	Importance of the operating manual	9
1.2	Intended use	9
1.3	Warranty and liability	9
1.4	Copyright	10
1.5	Standards and regulations	10
1.6	Scope of Supply	10
2	Layout and mode of operation	11
2.1	Layout of the centrifuge	11
2.1.1	Functional and operating elements	11
2.1.2	Name plate	12
2.2	Mode of operation	13
2.2.1	Centrifugation principle	13
2.2.2	Area of application	13
2.2.2.1	Speed, radius, and relative centrifugal force	14
2.2.2.2	Density	14
3	Safety	15
3.1	Marking of the unit	15
3.2	Explanation of the symbols and notes	16
3.3	Responsibility of the operator	17
3.4	Operating personnel	17
3.5	Informal safety instructions	17
3.6	Safety instructions	18
3.6.1	Electrical safety	18
3.6.2	Mechanical safety	18
3.6.3	Fire prevention	19
3.6.4	Chemical and biological safety	19
3.6.5	Safety instructions for centrifugation	20
3.6.6	Resistance of plastics	20
3.6.7	Safety of rotors and accessories	21
3.6.7.1	Service life	21
3.6.7.2	Marking	22
3.7	Safety devices	23
3.7.1	Lid lock device	23
3.7.2	Standstill monitoring system	23
3.7.3	System check	23
3.7.4	Earth conductor check	23
3.7.5	Imbalance monitoring system	23
3.7.6	Temperature monitoring system	23
3.7.7	Rotor monitoring system	23
3.8	Measures in the event of hazards and accidents	24
3.9	Remaining hazards	24

Table of contents

4	Storage and transport	25
4.1	Dimensions and weight.....	25
4.2	Storage conditions	25
4.3	Notes on transport	25
4.4	Packaging.....	26
4.5	Transport safety device.....	26
5	Set-up and connection	27
5.1	Installation site	27
5.2	Power supply	27
5.2.1	Type of connection	27
5.2.2	Customer-provided fuses.....	27
6	Using the centrifuge	29
6.1	Initial start-up	29
6.2	Switching the centrifuge on	29
6.2.1	Opening and closing the lid.....	29
6.2.2	Installation of rotors and accessories	30
6.2.2.1	Installation of a rotor	30
6.2.2.2	Installation of an angle rotor with a hermetic lid.....	30
6.2.2.3	Installation of accessories	32
6.2.2.4	Adapters	34
6.2.2.5	Vessels	34
6.2.2.6	Blood bag systems.....	35
6.2.2.7	Centrifugation with tubes for mineral oil	36
6.3	Control system "Spincontrol S"	37
6.3.1	User interface	37
6.3.2	Manual mode.....	38
6.3.2.1	Starting a centrifugation run	38
6.3.2.2	Interrupting a centrifugation run	38
6.3.2.3	Interrupting a deceleration process	38
6.3.2.4	Selection, display, and modification of data.....	38
6.3.2.5	Standard menu	39
6.3.2.6	Process library menu	45
6.3.2.7	Parameters menu	46
6.3.2.8	Setup menu	50
6.3.2.9	Curve menu	53
6.3.2.10	Help menu	54
6.3.2.11	Changing the contrast.....	55
6.3.3	Program mode.....	55
6.3.3.1	Saving a program.....	56
6.3.3.2	Loading a program.....	56
6.3.3.3	Executing a program.....	57
6.3.3.4	Deleting a program	57
6.3.3.5	Automatic program rotation.....	58
6.3.4	Options for data input and output.....	59

Table of contents

6.4	Switching the centrifuge off	59
7	Malfunctions and error correction	60
7.1	General malfunctions	60
7.1.1	Emergency lid release	61
7.2	Table of error codes.....	62
7.3	Service contact	63
8	Maintenance and service.....	64
8.1	Maintenance	64
8.1.1	Centrifuge	64
8.1.2	Accessories	65
8.1.2.1	Plastic accessories	65
8.1.3	Rotors, buckets and carriers	66
8.1.4	Load bearing bolts	67
8.1.5	Glass breakage	68
8.2	Sterilisation and disinfection of the rotor chamber and accessories	68
8.2.1	Autoclaving.....	69
8.3	Service	70
8.4	Return of defective centrifuges or parts	71
9	Disposal.....	73
9.1	Disposal of the centrifuge	73
9.2	Disposal of the packaging.....	73
10	Technical data.....	74
10.1	Ambient conditions	74
10.2	Technical documentation	75
11	Appendix	76
11.1	Range of accessories	76
11.1.1	Rotor radii.....	76
11.2	Speed-gravitational-field-diagram	77
11.3	Acceleration and deceleration curves	78
11.4	Table of the service life of rotors and accessories.....	80
11.5	Resistance data	81
11.6	EC declaration of conformity	85
11.7	Declaration of conformity – China RoHS 2.....	87
12	Index	89

Table of contents

1 General information

1.1 Importance of the operating manual

A fundamental requirement for the safe and trouble-free operation of the centrifuge is to be familiar with the fundamental safety instructions and all possible hazards.

The operating manual includes important information concerning the safe operation of the centrifuge.

This operating manual and, in particular, the notes on safety and hazards must be observed by all persons operating the centrifuge.

In addition, the local rules and regulations for the prevention of accidents must be complied with.

1.2 Intended use

Centrifuges are power-driven machines that separate liquids from solid matter, liquid mixtures, or solid mixtures by centrifugal force. They are solely intended for this purpose. Any other use beyond this area of application is regarded as improper use. Sigma Laborzentrifugen GmbH cannot be held liable for any damage resulting from such improper use.

The intended use also includes

- observation of all the notes and instructions included in the operating manual and
- compliance with the care, cleaning, and maintenance instructions.

1.3 Warranty and liability

The warranty and liability are subject to our "General Conditions" that were distributed to the operator upon the conclusion of the contract.

Warranty and liability claims are excluded if they are due to:

- improper use.
- non-compliance with the safety instructions and hazard warnings in the operating manual.
- improper installation, start-up, operation, or maintenance of the centrifuge.

1 General information

1.4 Copyright

The copyright concerning the operating manual remains with Sigma Laborzentrifugen GmbH.

The operating manual is solely intended for the operator and their personnel. It includes instructions and information that must not be

- duplicated,
- distributed, or
- communicated in any other way.

Non-compliance may be prosecuted under criminal law.

1.5 Standards and regulations

EC declaration of conformity

(see chapter 11.6 - "EC declaration of conformity")

1.6 Scope of Supply

The centrifuge comprises:

- | | |
|--|------------------|
| • 1 rotor wrench, size 13 | Part no. 930 102 |
| • 1 hexagon socket wrench (size 5) | Part no. 930 051 |
| • 1 tube (30 g) heavy-duty grease for load-bearing bolts | Part no. 71 401 |

Documentation

Operating manual incl. EC declaration of conformity
(see chapter 11.6 - "EC declaration of conformity")

Accessories

according to your order, our order confirmation, and our delivery note.

2 Layout and mode of operation

2.1 Layout of the centrifuge

2.1.1 Functional and operating elements

- 1 Lid
- 2 User interface (see chapter 6.3.1 - "User interface")
- 3 Mains switch



Fig. 1: Total view of the centrifuge

- 4 Name plate (see chapter 2.1.2 - "Name plate")
- 5 Fuse holder
- 6 Mains cable

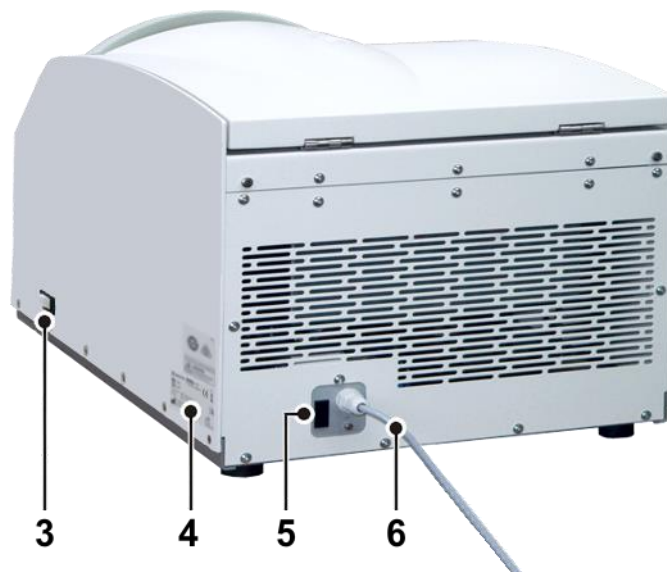

Fig. 2: Rear view of the centrifuge

2 Layout and mode of operation

2.1.2 Name plate

- 1 Manufacturer
- 2 Power consumption
- 3 Max. speed
- 4 Max. kinetic energy
- 5 Serial number
- 6 Part number
- 7 Type
- 8 Nominal voltage
- 9 CE mark in compliance with the directive 2006/42/EC
- 10 Symbol for special disposal (see chapter 9 - "Disposal")
- 11 Consult operating manual
- 12 Date of manufacture
- 13 Max. permissible density

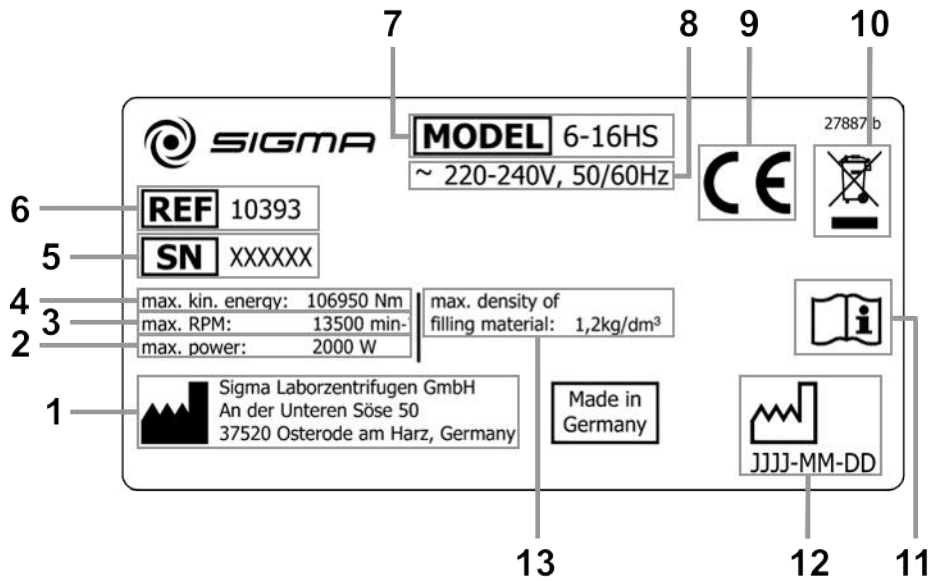

Fig. 3: Example of a name plate

2.2 Mode of operation

2.2.1 Centrifugation principle

Centrifugation is a process for the separation of heterogeneous mixtures of substances (suspensions, emulsions, or gas mixtures) into their components. The mixture of substances, which rotates on a circular path, is subject to centripetal acceleration that is several times greater than the gravitational acceleration.

Centrifuges use the mass inertia inside the rotor chamber for separating the substances. Due to their higher inertia, particles or media with a higher density travel outwards. In doing so, they displace the components with a lower density, which in turn travel towards the centre.

The centripetal acceleration of an object inside a centrifuge, as the effect of centripetal force, depends on the distance between the object and the axis of rotation as well as on the angular velocity. It increases linearly as a function of the distance with regard to the axis of rotation and quadratically as a function of the angular velocity. The bigger the radius in the rotor chamber is and the higher the speed is, the higher the centripetal acceleration is. However, the forces acting on the rotor also increase.

2.2.2 Area of application

Depending on the area of application of the centrifuge and also on the particle size, solids content, and volume throughput of the mixture of substances that is to be centrifuged, there are different types of centrifuges.

The areas of application go from household use as a salad spinner or honey separator up to specialised technical applications in the clinical, biological, or biochemical context:

- For numerous clinical examinations, cellular material must be separated from the liquid to be analysed. The normal separation process can be sped up considerably by using laboratory centrifuges.
- In the metal-working industry, centrifuges are used for separating oil from metal cuttings. Dairies use centrifuges in order to separate cow's milk into cream and low-fat milk.
- Particularly big centrifuges are used in the sugar industry for separating the syrup from the crystalline sugar.
- Ultracentrifuges are predominantly used in biology and biochemistry in order to isolate particles, e.g. viruses. They are specifically designed for high speeds up to 500,000 rpm. The rotor moves in a vacuum in order to avoid air friction.

2 Layout and mode of operation

2.2.2.1 Speed, radius, and relative centrifugal force

The acceleration g , which the samples are subject to, can be increased by increasing the radius in the rotor chamber and by increasing the speed. These three parameters are interdependent and linked with each other via the following formula:

$$\text{Relative centrifugal force RCF} = 11.18 \times 10^{-6} \times r \times n^2$$

r = radius in cm

n = speed in rpm

RCF without any dimension

If two values are entered, the third value is determined by way of the stated formula. If, afterwards, the speed or the radius is changed, the resulting relative centrifugal force will be recalculated automatically by the control unit. If the RCF is changed, the speed will be adapted while the specified radius is maintained.

The speed-gravitational-field-diagram provides an overview of the relationship between speed, radius, and RCF (see chapter 11.2 - "Speed-gravitational-field-diagram").

2.2.2.2 Density

The laboratory centrifuge is suitable for the separation of constituents of different densities in mixtures with a maximum density of 1.2 g/cm^3 . All information concerning the speed of rotors and accessories refers to liquids with a density corresponding to this specification. If the density is above this value, the maximum permissible speed of the centrifuge must be reduced based on the following formula:













$$n = n_{\max} \times \sqrt{(1,2 / \text{Rho})}$$

Rho = density in g/cm^3

3 Safety

3.1 Marking of the unit

The following symbols are used for all types of centrifuges manufactured by Sigma:

	Dangerous voltage		On (Power)
	Hot surface		Off (Power)
	Caution! Risk of bruising		Name plate (see chapter 2.1.2 - "Name plate")
	Protective earth (ground)		CE mark in compliance with the directive 2006/42/EC
	Earth (ground)		Do not dispose as part of domestic waste
	g-lock®-System installed		Unplug the mains plug
	Arrow indicating the direction of rotation		GS mark (tested safety; only for Germany)
	4°C Guarantee		NRTL mark (only for the USA and Canada)
	Centrifuge with heating system		RCM mark (only for Australia)
	Rotor loading information (see chapter 6.2.2.3 - "Installation of accessories")		China RoHS 2 mark (only for China)

3 Safety



Safety indications on the centrifuge must be kept readable at all times. If necessary, they must be replaced.



Not all of the symbols/labels are used for this centrifuge type.

3.2 Explanation of the symbols and notes

In this operating manual, the following names and symbols to indicate hazards are used:



This symbol stands for a **direct** hazard to the life and health of persons.

Non-observance of these symbols **causes** serious health problems up to life-endangering injuries.



This symbol stands for a **direct** hazard to the life and health of persons due to electrical voltage.

Non-observance of these symbols **causes** serious health problems up to life-endangering injuries.



This symbol stands for a **potential** hazard to the life and health of persons.

Non-observance of these symbols **can** cause serious health problems up to life-endangering injuries.



This symbol indicates a potentially hazardous situation

Non-observance of these notes can cause minor injuries or damage to property.



This symbol indicates important information.

3.3 Responsibility of the operator

The operator is responsible for authorising only qualified personnel to work on the centrifuge (see chapter 3.4 - "Operating personnel").

The areas of responsibility of the personnel concerning the operation, maintenance, and care of the unit must be clearly defined.

The safety-conscious work of the personnel in compliance with the operating manual and the relevant EC and national health and safety regulations as well as with the accident prevention regulations must be checked at regular intervals (e.g. every month).

Under the international rules for health and safety at work, the operator is obliged to:

- take measures in order to prevent all danger to life or health during work.
- ensure that centrifuges are operated properly and entirely as intended (see chapter 1.2 - "Intended use").
- take protective measures against fire and explosion when working with hazardous substances.
- take measures for the safe opening of centrifuges.

The operator must perform a risk assessment concerning potential accidents in connection with the centrifuge and take design-related countermeasures, if necessary.

The centrifuge has to be maintained regularly (see chapter 8 - "Maintenance and service").

Components that are not in a perfect state must be replaced immediately.

3.4 Operating personnel

Persons operating the unit must

- be familiar with the fundamental regulations concerning workplace safety and accident prevention
- have read and understood this operating manual (and in particular the safety sections and warning notes) and confirmed this with their signature.

3.5 Informal safety instructions

- This operating manual is a part of the product.
- The operating manual must be kept at the location of use of the centrifuge. Ensure that it is accessible at all times.
- The operating manual must be handed over to any subsequent owner or operator of the centrifuge.
- Any changes, additions or updates received must be added to the operating manual.
- In addition to the operating manual, the general and local rules and regulations concerning the prevention of accidents and the protection of the environment must also be supplied.
- Safety and danger indications on the centrifuge must be kept readable at all times. If necessary, they must be replaced.

3 Safety

3.6 Safety instructions

3.6.1 Electrical safety

To reduce the risk of electrical shock, the centrifuge uses a three-wire electrical cord and plug to connect the equipment to earth-ground. To preserve this safety feature:



DANGER

- Ensure that the wall socket is properly wired and grounded.
- Check that the mains voltage agrees with the nominal voltage listed on the name plate.
- Do not place vessels containing liquid on the centrifuge lid or within the safety distance of 30 cm around the centrifuge. Spilled liquids may get into the centrifuge and damage electrical or mechanical components.
- Only qualified and specialised personnel are authorised to perform service tasks or repairs of the electrical system for which the housing needs to be removed.
- Inspect the electrical equipment of the unit regularly. Defects such as loose or burnt cables must be eliminated immediately.
- Following the completion of any type of repair or service, the qualified and specialised personnel must perform final inspection and testing in compliance with the relevant standards.

3.6.2 Mechanical safety

In order to ensure the safe operation of the centrifuge, observe the following:



WARNING

- Do not open the lid when the rotor is in motion!
- Do not reach into the rotor chamber when the rotor is in motion!
- Do not use the centrifuge if it was installed incorrectly.
- Do not use the centrifuge without panels.
- Do not use the centrifuge if the rotors and inserts show signs of corrosion or other defects.
- Only use the centrifuge with rotors and accessories that have been approved by the manufacturer. In case of doubt, contact the manufacturer (see chapter 7.3 - "Service contact").
- Do not hold your fingers between the lid and the housing when closing the lid. Risk of crushing!
- Defective lid relieving devices could cause the centrifuge lid to fall (contact the service department, if necessary). Risk of crushing!
- Do not hit or move the centrifuge during its operation.
- Do not lean against or rest on the centrifuge during its operation.
- Do not spin any substances that could damage the material of the rotors and buckets of the centrifuge in any way. Highly corrosive substances, for example, damage the material and affect the mechanical strength of the rotors and buckets.
- Stop the centrifuge immediately in the event of a malfunction. Eliminate the malfunction (see chapter 7 - "Malfunctions and error correction") or inform the service department of the manufacturer (see chapter 7.3 - "Service contact").

**WARNING**

- Ensure that all repairs are performed only by authorised and specialised personnel.
- Prior to any start-up, check the centrifuge, rotor, and accessories for signs of damage that can be discerned from the outside. Special attention must be paid to all of the rubber parts (e.g. motor cover, lid seal, and adapters) in terms of visible structural changes. Defective parts must be replaced immediately.
- Open the centrifuge when it is not in use so that moisture can evaporate.

3.6.3 Fire prevention

**DANGER**

- Do not spin explosive or inflammable substances.
- Do not use the centrifuge within hazardous locations.

3.6.4 Chemical and biological safety

If pathogenic, toxic, or radioactive samples are intended to be used in the centrifuge, it is in the responsibility of the user to ensure that all necessary safety regulations, guidelines, precautions, and practices are adhered to accordingly.

**DANGER**

- Infectious, toxic, pathogenic, and radioactive substances may only be used in special, certified containment systems with a bio-seal in order to prevent the material from being released.
- Take suitable precautions for your own safety if there is a risk of toxic, radioactive, or pathogenic contamination
- Materials that chemically react with each other with a high level of energy are prohibited.

**WARNING**

- Keep informed about local measures to avoid harmful emissions (depending on the substances to be centrifuged).
- Protective clothing is not required for the operation of the centrifuge. The materials to be centrifuged may, however, require special safety measures (e.g. centrifugation of infectious, toxic, radioactive, or pathogenic substances).

3 Safety

3.6.5 Safety instructions for centrifugation

For safe operation, observe the following before starting the centrifuge:



WARNING

- Ensure that the centrifuge was set up properly (see chapter 5 - "Set-up and connection").
- Maintain a safety distance of at least 30 cm (12 inches) around the centrifuge.
- Do not store any dangerous goods in the centrifuge area.
- Do not stay in the safety area longer than what is absolutely necessary for the operation of the centrifuge.
- Only use the centrifuge with rotors and accessories that have been approved by the manufacturer. We explicitly warn against the use of equipment of poor quality. Breaking glass or bursting vessels can cause dangerous imbalances at high speeds
- Ensure that rotor and buckets are correctly fitted (see chapter 6.2.2.1 - "Installation of a rotor").
- Observe the instructions on the installation of accessories (see chapter 6.2.2.3 - "Installation of accessories").



WARNING

- The rotor must be loaded in a rotationally symmetrical manner at equal weights.
- If liquids with a density $> 1.2 \text{ g/cm}^3$ are used, reduce the speed (see chapter 2.2.2.2 - "Density").
- Do not use the centrifuge if the rotor is loaded asymmetrically.
- Do not use the centrifuge with tubes that are excessively long.

3.6.6 Resistance of plastics

Chemical influences have a strong effect on the polymeric chains of plastics, and, therefore, on their physical properties. Plastic parts can be damaged if solvents, acids, or alkaline solutions are used.



NOTE

- Refer to the resistance data (see chapter 11.5 - "Resistance data")!

3.6.7 Safety of rotors and accessories

3.6.7.1 Service life

The rotors and accessories have a limited service life.



WARNING

- Perform regular checks (at least once per month) for safety reasons!
- Pay special attention to changes, such as corrosion, cracks, material abrasion, etc.
- After 10 years, they must be inspected by the manufacturer.
- After 50,000 cycles, the rotor must be scrapped for reasons of safety.
- If other data concerning the service life are engraved on the rotor or bucket, these data shall apply accordingly. For example, a bucket with the engraving "max. cycles = 10,000" has a service life of 10,000 cycles, and a rotor with the engraving "Exp. date 01/27" must be scrapped in January 2027 at the latest (see figure).
- If a specification concerning the maximum number of cycles **and** a specification concerning the service life (i.e. a date) are provided, the specification that occurs first shall apply.



Fig. 4: Different service life – engraving on the bucket/rotor



- Refer to the table of rotors and accessories with a different service life (see chapter 11.4 - " Table of the service life of rotors and accessories ")!

3 Safety

3.6.7.2 Marking

During production, every rotor and bucket receives a batch number enabling conclusions to be drawn concerning the production process and the subsequent quality inspection. Some rotors also have an additional serial number providing further detailed information.

The batch number and serial number is engraved on the rotor as follows:

- 1 Batch number
- 2 Serial number

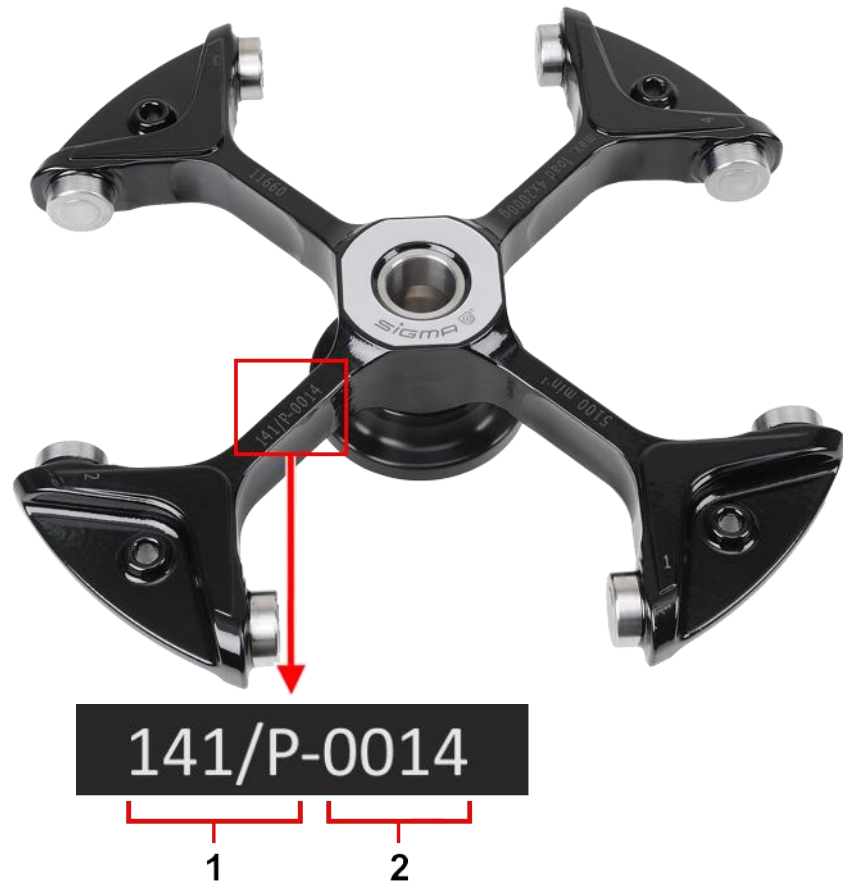

Fig. 5: Rotor with an engraved batch number and serial number (example)



If there are any enquiries concerning the rotor, please state the batch number and serial number!

3.7 Safety devices

3.7.1 Lid lock device

The centrifuge can only be started when the lid is properly closed. The electrical lock must be locked. The lid can only be opened when the rotor has stopped. If the lid is opened by way of the emergency release system during operation, the centrifuge will immediately switch off and decelerate brakeless. If the lid is open, the drive is completely separated from the mains power supply, i.e. the centrifuge cannot be started (see chapter 7.1.1 - "Emergency lid release").

3.7.2 Standstill monitoring system

Opening of the centrifuge lid is only possible if the rotor is at a standstill. This standstill is checked by the microprocessor.

3.7.3 System check

An internal system check monitors the data transfer and sensor signals with regard to plausibility. Errors are detected with extreme sensitivity and displayed as error messages in a dialog box (see chapter 7.2 - "Table of error codes").

3.7.4 Earth conductor check

An earth conductor check can be carried out by authorised and specialised personnel using a suitable measuring instrument. Please contact the Sigma service department (see chapter 7.3 - "Service contact").

3.7.5 Imbalance monitoring system

A dialog box may pop up or emit a sound signal in order to indicate that the centrifuge is in the inadmissible imbalance range. If the rotor is loaded unevenly, the drive will be switched off in the acceleration phase or during the run.

3.7.6 Temperature monitoring system

If the temperature inside the rotor chamber rises above +70°C, the drive system will be switched off automatically. The centrifuge cannot be restarted until it has cooled.

3.7.7 Rotor monitoring system

When a rotor number and, if applicable, a bucket number are selected, the computer will automatically check whether the entered speed or the entered gravitational field are permissible for the selected rotor.

3 Safety

3.8 Measures in the event of hazards and accidents



DANGER

- If an emergency arises, switch off the centrifuge immediately!
- If in doubt, call the emergency doctor!

3.9 Remaining hazards

The centrifuge was built in accordance with the state of the art and in compliance with the generally recognized safety rules. However, danger to life and limb of the operator, or of third parties, or impairments of the unit or other material assets cannot be completely excluded when the unit is being used.

- Use the unit only for the purpose that it was originally intended for (see chapter 1.2 - "Intended use").
- Use the unit only if it is in a perfect running state.
- Immediately eliminate any problems that can affect safety.

4 Storage and transport

4.1 Dimensions and weight

	Sigma 6-16HS
Height:	483 mm
Height with open lid:	990 mm
Width:	581 mm
Depth:	711 mm
Weight:	116 kg

4.2 Storage conditions

The centrifuge can be stored in its original packaging for up to a year.

- Store the centrifuge only in dry rooms.
- The permissible storage temperature is between -20°C and +60°C.
- If you would like to store it for more than one year, or if you intend to ship it overseas, please contact the manufacturer.

4.3 Notes on transport

- Install the transport safety device (see chapter 4.5 - "Transport safety device")
- Always lift the centrifuge with a lifting device.
- When lifting the centrifuge, always reach under the centrifuge from the side.



CAUTION

The centrifuge weighs approx. 116 kg!

- For transport, use suitable packaging and, if at all possible, the original packaging (see chapter 4.4 - "Packaging").

4 Storage and transport

4.4 Packaging

The centrifuge is packaged in a wooden crate.

- After taking off the lid, remove the side panels.
- Remove the packaging material.
- Lift the centrifuge upwards with a lifting device to lift it safely. When lifting the centrifuge, always reach under the centrifuge from the side.



CAUTION

The centrifuge weighs approx. 116 kg!

- Retain the packaging for any possible future transport of the centrifuge.

4.5 Transport safety device

The transport safety device consists of two plastic screws which are located at the bottom panel.



CAUTION

The transport safety device must be removed prior to start-up because the screws lock the motor bearings!

Removal

- Lift the centrifuge upwards at the front side. Always reach under from the side.
- Put a suitable object, e.g. a wooden block, between the table and centrifuge. The two plastic screws can now be seen at the bottom panel.

1 Locking screws

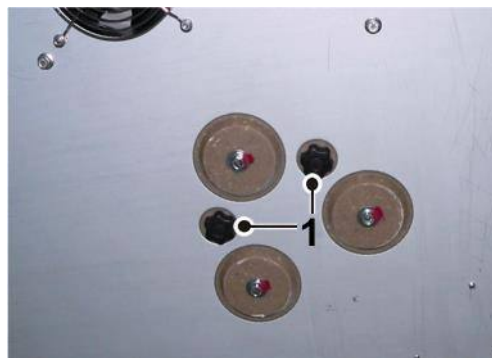

Fig. 6: Locking screws (transport safety device)

- Unscrew the screws by hand anti-clockwise.
- Retain the transport safety device for the possibility of the return of the centrifuge.

5 Set-up and connection

5.1 Installation site

Operate the centrifuge only in closed and dry rooms.

All the energy supplied to the centrifuge is converted into heat and emitted to the ambient air.

- Ensure sufficient ventilation.
- Keep a safety distance of at least 30 cm around the centrifuge so that the vents in the centrifuge remain fully effective.
- Do not subject the centrifuge to thermal stress, e.g. by positioning it near heat generators.
- Avoid direct sunlight (UV radiation).
- The table must be stable and have a solid, even surface.
- Attention: During transport from cold to warmer places, condensational water will collect inside the centrifuge. It is important to allow sufficient time for drying (min. 24 h) before the centrifuge can be used again.

5.2 Power supply

5.2.1 Type of connection



DANGER

The operating voltage on the name plate must correspond to the local supply voltage!



CAUTION

The mains power plug is an isolating device which is why it must be accessible at all times.

Sigma centrifuges are units of protection class I. The centrifuges of this model series have a three-wire power cord with a fixed cable. They are equipped with a mains power switch with an integrated thermal circuit breaker.

- Switch the unit off by actuating the mains power switch.
- If it has tripped, let the circuit breaker cool for approximately 2 minutes.
- Switch the unit on.

The centrifuge is now ready for operation.

5.2.2 Customer-provided fuses

Typically, the centrifuge must be protected with 16 Amp L or B fuses that are to be provided by the customer.

5 Set-up and connection



To ensure safe disconnection in the event of a fault, an AC/DC-sensitive RCD (residual current device) must be integrated in the wiring system of the building.

6 Using the centrifuge

6.1 Initial start-up



DANGER

- Before the initial start-up, please ensure that your centrifuge is properly set up and installed (see chapter 5 - "Set-up and connection").

6.2 Switching the centrifuge on

- Press the mains power switch.

The display then illuminates. The centrifuge is ready for operation.



NOTE

As a default setting of the 6-16HS, the petroleum program "ASTM oil" is stored in the system (see chapter 6.3.2.5 - "Standard menu").

6.2.1 Opening and closing the lid

The lid can be opened if the centrifuge is at a standstill and if the lid key is illuminated.

- Press the lid key in order to open the lid.

The centrifuge cannot be started if the lid is opened.

- To close, press with both hands slightly on the lid until the lock is audibly locked.



WARNING

Do not place your fingers between the lid and the housing when closing the lid. Risk of crushing!

6 Using the centrifuge

6.2.2 Installation of rotors and accessories

6.2.2.1 Installation of a rotor

- Open the centrifuge lid by pressing the lid key.
- Unscrew the rotor tie-down screw from the motor shaft (counter-clockwise).
- Lower the rotor with its central bore straight down onto the motor shaft.
- Tighten the rotor tie-down screw clockwise with the supplied rotor wrench with 10 Nm (Option: torque wrench 10 Nm, part no. 17060). In doing so, hold the rotor at its outer rim.
- Follow the safety instructions and hazard warnings (see chapter 3 - "Safety")!



WARNING

Once a day or after 20 cycles, the rotor tie-down screw must be loosened by some turns, and the rotor must be lifted and fastened again. This ensures a proper connection between the rotor and the motor shaft.



CAUTION

When using rotors for microtiter plate formats:

Ensure that the plate holders are inserted together with the plates into the buckets.



NOTE

The lid screw serves for the fastening of the lid onto the rotor only, not for the fastening of the rotor onto the motor shaft.

Removal of a rotor

- Loosen the rotor tie-down screw by turning it anti-clockwise and remove the rotor.

6.2.2.2 Installation of an angle rotor with a hermetic lid

- Open the centrifuge lid by pressing the lid key.
- Unscrew the rotor tie-down screw from the motor shaft (counter-clockwise).
- Screw the hermetic lid onto the rotor and tighten it clockwise by hand.
- Lower the rotor with the lid with its central bore straight down onto the motor shaft.
- Insert the rotor tie-down screw into the motor shaft. Tighten the rotor tie-down screw clockwise with the supplied rotor wrench with 10 Nm (Option: torque wrench 10 Nm, part no. 17060). In doing so, hold the rotor at its outer rim.
- Follow the safety instructions and hazard warnings (see chapter 3 - "Safety")!



The rotor can also be used without a lid.



The lid screw serves for the fastening of the lid onto the rotor only, not for the fastening of the rotor onto the motor shaft.

Removing a rotor

- Loosen the rotor tie-down screw anti-clockwise and remove the rotor together with the lid.
- Loosen the lid by turning it anti-clockwise and then remove it.

- 1 Rotor tie down screw
- 2 Lid
- 3 Rotor

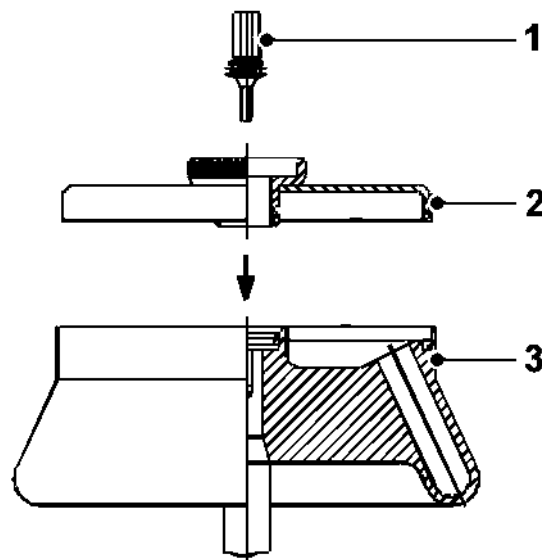

Fig. 7: Angle rotor with a hermetic lid

6 Using the centrifuge

6.2.2.3 Installation of accessories

- Only use vessels that are suitable for the rotor.
- In the case of swing-out rotors, all of the compartments must be equipped with buckets.
- Always load rotationally symmetrical compartments of the rotors with the same accessories and fill to avoid imbalance.

Centrifugation with vessels of various sizes

Working with vessel of various sizes is possible. In this case, however, it is very important that the rotationally symmetrical inserts are identical (see figure).

correct

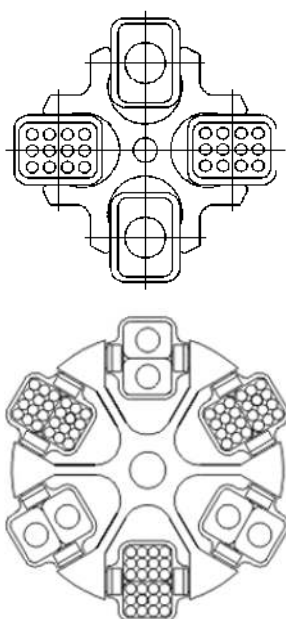

incorrect

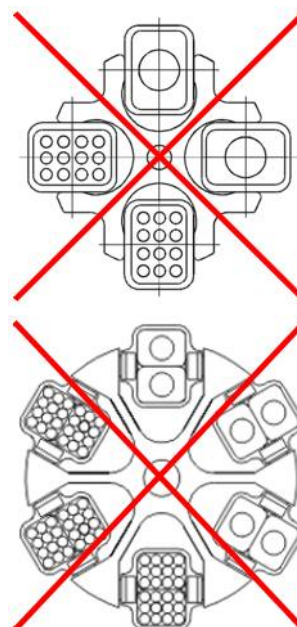

Fig. 8: Permissible and impermissible loading of a swing-out rotor with vessels of various sizes (example illustration)

6 Using the centrifuge

Centrifugation with low capacity

- Install the sample vessels in a rotationally symmetrical manner so that the buckets and their suspensions are loaded evenly.
- It is not permissible to load angle rotors on only one axis.

correct

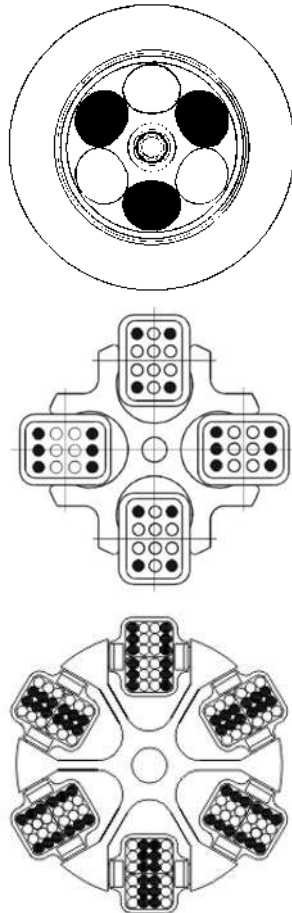

incorrect

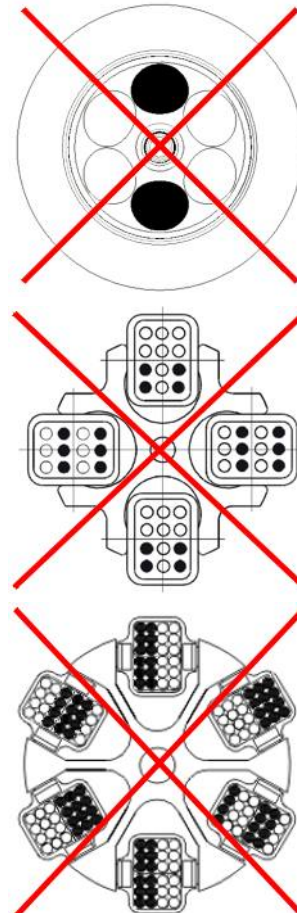

Fig. 9: Permissible and impermissible loading of an angle rotor and a swing-out rotor (example illustrations)

i
NOTE

Pay attention to the marking of the centrifuge (see the illustration below)! Safety indications on the centrifuge must be kept readable at all times. If necessary, they must be replaced.

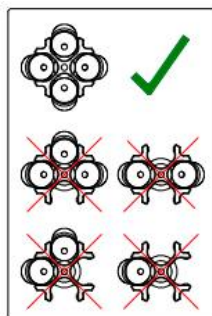

Fig. 10: Safety indication on the centrifuge: Loading of a swing-out rotor

6 Using the centrifuge

Double rectangular bucket 13420 and bucket 13621

The double rectangular bucket 13420 and the bucket for microtiter plates 13621 are dynamically balanced at the factory. Therefore, the buckets must be installed in sets of 4 and in the prescribed order (see the numbers on the buckets and on the rotor).



CAUTION

Mixed use with only two buckets on opposite sides will cause increased imbalance!

6.2.2.4 Adapters

In order to ensure easy handling, even if vessels of various sizes are used, carrier systems were developed.

- Load the opposite adapters with the same number of vessels and with the same weights in order to avoid imbalance.
- If all of the compartments of a carrier are not used, the buckets must be loaded evenly. Loading the edges of a bucket only is not permissible.

6.2.2.5 Vessels

- Load the vessels outside of the centrifuge. Liquids in the buckets or multiple carriers cause corrosion.
- Fill the vessels carefully and arrange them according to their weight. Imbalances result in the excessive wear of the bearings.
- Always fill the tubes up to their useful volume (= the volume that is stated for the tube).
- Follow the safety instructions and hazard warnings (see chapter 3 - "Safety")!

Maximum speed for tubes

Some tubes, such as centrifuge glass tubes, microtubes, culture tubes, fluoropolymer tubes and especially high-volume tubes can be used in our rotors, buckets, and adapters at higher speeds than their breaking limit.



NOTE

When using glass vessels, the maximum value of 4,000 x g must not be exceeded (except special high-strength glass tubes; please refer to the information provided by the manufacturer).



NOTE

When installing the 500 ml bottles use the supplied supporting rings

6.2.2.6 Blood bag systems

The centrifuge tolerates an imbalance of approx. 20 g. Therefore, it is important to balance the buckets carefully.

- All four places of a rotor must be loaded with buckets. It is permissible to fill just two opposite buckets with blood bag systems.
- The opposite buckets including the filled blood bag systems must have an equal weight.
- The blood bags have to be put into the opposite buckets mirror-inverted.
- If in one bucket the main blood bag is on the left side, then the main blood bag inserted in the opposite bucket has to be on the right side.

- 1 Filter
2 Blood bag

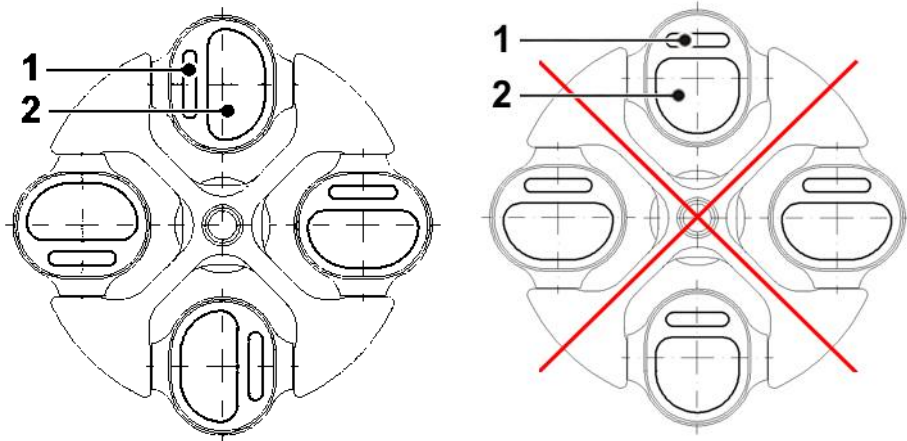

Fig. 11: Loading of blood bag systems

- When using smaller bag systems or in case of incompletely filled blood bags adapters (e.g. part no. 17750) have to be inserted together with the blood bag systems. This will avoid slipping of the bags which could result in an imbalance.
- For the centrifugation of human blood suitable acceleration and deceleration curves must be used. Curve no. 12 is the most suitable for this purpose.

6 Using the centrifuge

A German blood bank works successfully using the following data:

Temperature ¹⁾	Speed	RCF	Timet	Acceleration curve ²⁾	Deceleration curve	Program
°C	rpm	x g	min	no.	no.	
22	3,750	4,544	7	20 (2 min)	12	1 Full blood
22	3,570	4,544	10	20 (2 min)	12	2 Full blood in 4fold bags
20	4,000	5,170	12	24 (3 min)	12	3 Plasma with buffy coat
22	3,750	4,544	9	20 (2 min)	12	4 Full blood
20	4,000	5,170	14	24 (3 min)	12	5 Plasma with buffy coat
22	1,094	384	7	21 (2 min)	11 or 2 min	6 Platelets with buffy coat
22	1,094	384	7	21 (2 min)	11 or 3.5min	7 Platelets with buffy coat

¹⁾ only with special equipment heater

²⁾ Curves no. 20, 21 and 24 are freely programmable curves



NOTE

If the centrifuge does not reach the mentioned RCF values, the maximum gravitational field must be set and the run time must be extended.

6.2.2.7 Centrifugation with tubes for mineral oil

In the ASTM standard, a maximum gravitational field of 800 x g is required for the centrifugation with tubes for mineral oil. Practically, it is possible to reach higher RCF-values with the rotor 11165 and the buckets 13113, 13114 or 13116.



CAUTION

The required gravitational field must not be exceeded. Values above 800 x g increase the risk of glass breakage!

This is why a program is stored in the system as a default setting of the centrifuge. This program is specifically adapted to the petroleum rotor 11165 with buckets of the 13113 type.

- Use sealing caps (part no. 17107).

6.3 Control system "Spincontrol S"

6.3.1 User interface

The centrifuge is operated via three buttons with integrated light-emitting diodes and one function knob. The display is divided into several different fields. The various functions of the system can be called up by pressing and turning the function knob.

- 1 Start button
- 2 Display
- 3 Function knob
- 4 Stop button
- 5 Lid button



Fig. 12: User interface of the Spincontrol S control system

Display

The centrifuge display has the following fields:

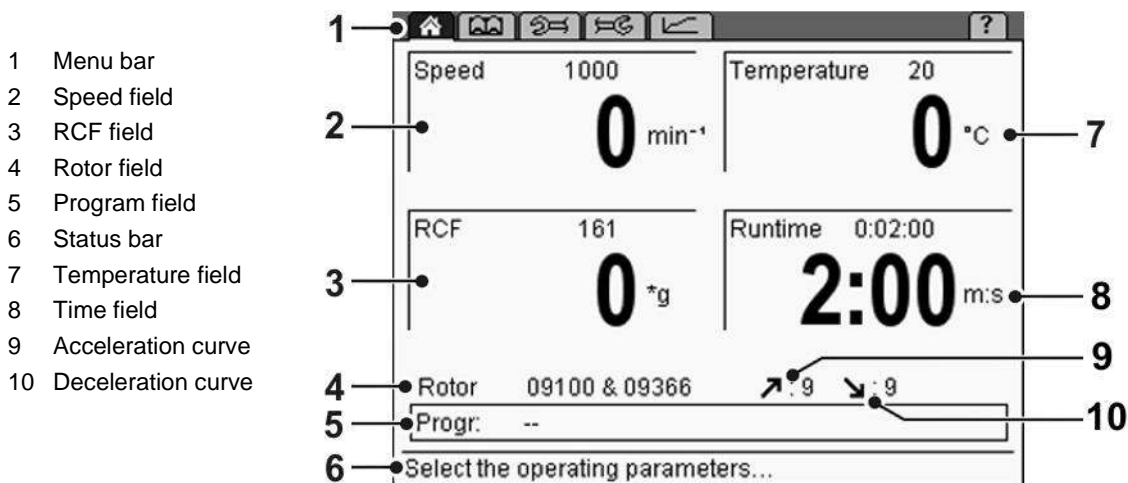

Fig. 13: Display of the Spincontrol S control system

6 Using the centrifuge

6.3.2 Manual mode

6.3.2.1 Starting a centrifugation run

The centrifuge is ready for operation when the start key is illuminated.

- Press the start key in order to start a centrifugation run.

6.3.2.2 Interrupting a centrifugation run

- Press the stop key in order to interrupt a centrifugation run. The centrifugation run will be terminated prematurely.

Quick stop

- Press the stop key for more than three seconds.

The centrifuge decelerates with the maximum deceleration curve.

After a quick stop, the centrifuge lid must be opened before a new centrifugation run can be started.

A quick stop can also be triggered during a normal deceleration, e.g. in order to speed up the deceleration.

When a quick stop is triggered, "Quick stop" will be displayed in the speed field.



A quick stop can be performed even if the centrifuge is blocked against unauthorised use.

6.3.2.3 Interrupting a deceleration process

- Press the start key during a deceleration process in order to interrupt it and to restart the centrifuge.

6.3.2.4 Selection, display, and modification of data

The "Standard" menu is displayed.

- Turn the function knob in order to select a field. The selected field is inverted.
- Press the function knob. The display starts to flash and the modification mode is active.
- Turn the function knob in order to modify the set value of the selected field.
- Press the function knob again to confirm the entry and to quit the modification mode.

6.3.2.5 Standard menu

The "Standard" menu is symbolised by the icon "🏠" on the menu bar and it is displayed a few seconds after the centrifuge has been switched on. In this menu, the parameters of a centrifugation run can be displayed and modified.



NOTE

As a default setting of the 6-16HS, the petroleum program "ASTM oil" is stored in the system (see the program list in this chapter).

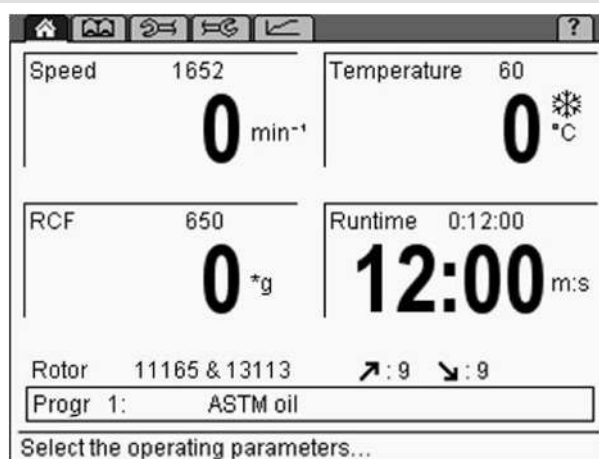

Fig. 14: Standard menu

Speed

In the upper section of the field, the set speed of the centrifuge is displayed. The actual speed is displayed below this value. The values are stated in revolutions per minute ($\text{min}^{-1} = \text{rpm}$) and depend on the RCF values (see chapter 2.2.2.1 - "Speed, radius, and relative centrifugal force"). The maximum speed values depend on the rotor that is used.

Relative centrifugal force (RCF)

The relative centrifugal force is the acceleration that the sample is subjected to during the centrifugation run. The set value of this parameter is displayed in the upper section of this field, with the actual value shown below. The values are stated in g (gravitational acceleration) and they depend on the speed values (see chapter 2.2.2.1 - "Speed, radius, and relative centrifugal force"). The maximum RCF values depend on the rotor that is used.



Temperature

The set temperature is displayed in the upper section of the field, with the current sample temperature shown below. Temperatures between -20°C and $+70^{\circ}\text{C}$ can be preselected. The maximum rotor temperature depends on the rotor that is used.

6 Using the centrifuge

Runtime

The set runtime is displayed in the upper section of this field, with the remaining runtime shown below. The runtime is defined as the period from the start of the centrifuge to the beginning of the deceleration phase. The maximum value is 99 h 59 min 59 sec.

In the "Setup" menu , it can be specified that the runtime is not to be started until the set speed is reached (see chapter 6.3.2.8 - "Setup menu"). In this case, the symbol "!" appears in the runtime field.

Continuous run

During the continuous run, the runtime of the centrifuge is unlimited and must be stopped manually. The centrifuge accelerates during the continuous run until the set speed is reached.

- Select the field "Runtime" and confirm the selection. The display flashes when it is activated.
- Turn the function knob from the time 0:00:10 anti-clockwise or from the time 99:59:59 clockwise. "Infinite" will be displayed. After the start of the centrifuge, the elapsed time will be displayed.
- Deactivate the continuous run by pressing the stop button or by entering a specific run time.

Short run

A short run can be started if no run is active.

- Keep the start button pressed during the short run.

During the short run, the centrifuge accelerates with the maximum acceleration curve until the maximum speed of the rotor is reached. The runtime is counted and in the speed field the message "Short run" flashes.

When the start button is released, the centrifuge decelerates at maximum brake to a standstill.



The parameters speed, RCF, temperature, and runtime can be changed during the centrifugation.



If the centrifuge is locked with level 02 or higher, it is not possible to start a short run.

Rotor: rotor selection list

This field shows the rotor that is currently being used.

- Select the field "Rotor" and confirm the selection. A list with all of the possible rotors without buckets is displayed.
- Select the desired rotor.
 - If an angle rotor is selected, additional information concerning this rotor will be displayed.
 - In the case of swing-out rotors, a list with all of the possible rotor/bucket combinations will be displayed. Select an item from the list so that the additional information concerning the combination will be displayed.
- Press the function knob in order to accept the data.

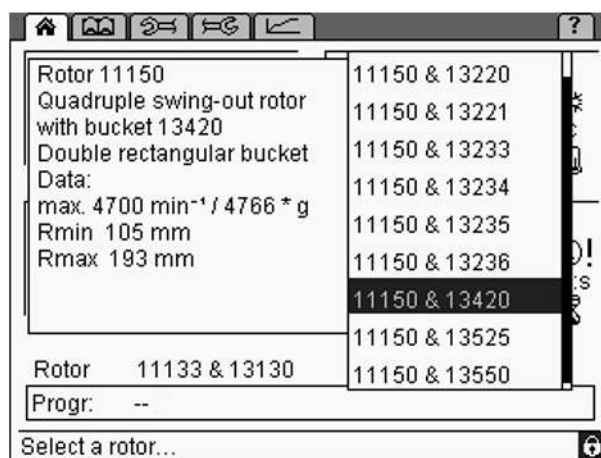

Fig. 15: Rotor selection list; here for a swing-out rotor

Automatic rotor identification

The centrifuge automatically identifies the rotor that is being currently used.

- If the system identifies a different rotor than the one that is set and if there are no different buckets for this rotor, the rotor input will be adapted automatically. The system will not display a message.
- If the system identifies a different rotor than the one that is set, and if there are different rotor/bucket combinations for this rotor, the system will automatically identify the correct rotor and select the rotor/bucket combination with the lowest speed. The system will display a corresponding message so that the combination can be adapted manually.
- If the system cannot identify the rotor, a message will be displayed. The rotor cannot be used in the centrifuge.

This prevents the maximum permissible speed from being exceeded.

6 Using the centrifuge

Acceleration ↗

This function is used to select an acceleration curve. One can select a linear rise (curves 0-9) or a quadratic rise (curves 10-19). The acceleration curves 20-29 can be programmed as desired (see chapter 11.3 - "Acceleration and deceleration curves").

Deceleration (Brake) ↘

This function is used to select a curve that decelerates the centrifuge to a standstill. Deceleration curves are inverted images of the acceleration curves and are labelled with identical numbers. Deceleration curve no. 0 represents a brakeless deceleration.

Progr.: program list

This field in the "Standard" menu shows the program that is currently loaded. When the field is selected, the program list is displayed (for information on how to work with the programs, please see chapter 6.3.3 - "Program mode").

The program "RAPID_TEMP" (see below) cannot be deleted.





Abb. 16: Program list

Programm "ASTM oil"

This program is stored in the system as a default setting of the centrifuge. It is specifically adapted to the petroleum rotor 11165 with buckets of the 13113 type.

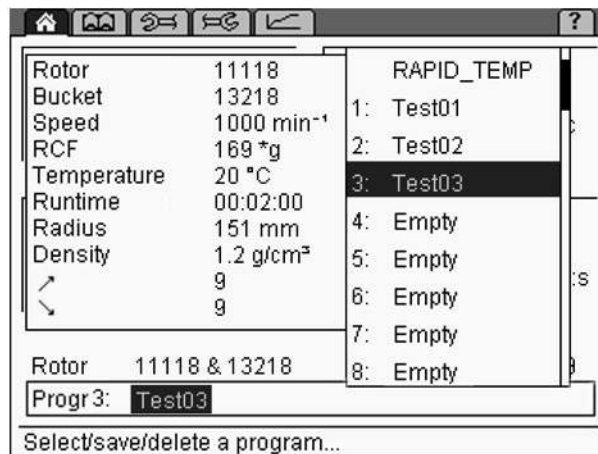
- Select the option "Progr" in the "Standard" menu  and confirm the selection. The program list will be displayed.
- Select the program "ASTM oil" from the list and confirm the input. The following values will be loaded:

Language:	English
Rotor/bucket:	11165/13113
RCF:	650
Temperature:	+60°C
Runtime:	12:00 min
Acceleration:	6
Deceleration:	6

In addition, the standstill heating will be activated and the automatic lid opening function will be disabled.

6 Using the centrifuge

Program "RAPID_TEMP"

Preheating at a standstill may distort the measurement results and subsequently cause increased wear of the mechanical components. This is why the centrifuge has a special program that preheats the centrifuge rapidly under defined conditions:

- Select the option "Progr" in the "Standard" menu  and confirm the selection. The program list will be displayed.
- Select the program "RAPID_TEMP" on the program list and confirm the selection. The display shows $\frac{1}{3}$ of the maximum rotor speed and the corresponding RCF value. The deceleration (brake) and acceleration curves correspond to curve 9 and the runtime field indicates "infinite" (continuous run).

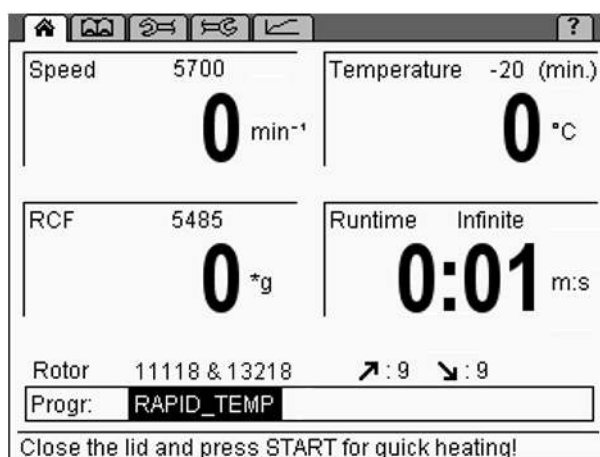

Fig. 17: Program "RAPID_TEMP"

i NOTE

The program will only be loaded if the actual temperature is below the set temperature.

- Press the start button in order to start the temperature control run.
- During the temperature control run, only the set temperature can be changed.

The current status of the program will be displayed on the status bar.

The "RAPID_TEMP" program will be stopped under the following conditions:

- The set value is reached. In this case, the "RAPID_TEMP" program stops with a sound signal (if this feature is activated), and the standstill heating system will be activated.
- The stop button is pressed. The "RAPID_TEMP" program will be stopped prematurely. No message will be issued when the set temperature is reached.
- A parameter is changed (except for the temperature) or another input is made. In this case, the "RAPID_TEMP" program will be aborted. No message will be issued when the set temperature is reached.

After the stop, the previous program will be reloaded or the changed parameters will be adopted as the new settings.

6 Using the centrifuge



The automatic lid opening function is suppressed after a temperature control run in order to prevent the material from cooling again.



The delta T temperature monitoring system (see chapter 6.3.2.7 - "Parameters menu", Process) remains inactive as long as the "RAPID_TEMP" program is active.



If the "RAPID_TEMP" program is used, the temperature of the unloaded aluminium bucket will be displayed. If samples, which have not been preheated, are placed into the buckets, the displayed temperature will deviate from the actual sample temperature.

Progress indicator

The progress indicator provides a quick overview of the remaining runtime of the running centrifugation run. For this purpose, a green progress bar and percentage value are displayed in the program field.

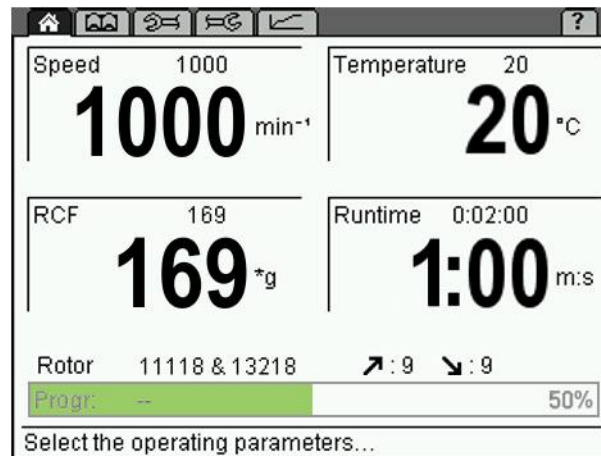

Fig. 18: Progress indicator during a centrifugation run

After the completion of the centrifugation run, the progress indicator remains at 100% until

- the lid is opened,
- a parameter is changed,
- a program is loaded, saved, or deleted, or
- a new centrifugation run is started.

6.3.2.6 Process library menu

The process library can be opened via the "📖" symbol on the menu bar. It provides the user with an overview of all of the stored programs as processes.

The processes are listed with their name, RCF, runtime, and temperature (exception: the "RAPID_TEMP" program will not be listed).

The order of the processes corresponds to their storage locations on the program list. Empty storage locations will not be displayed. If more than 11 programs have been stored, the user can scroll through the list.

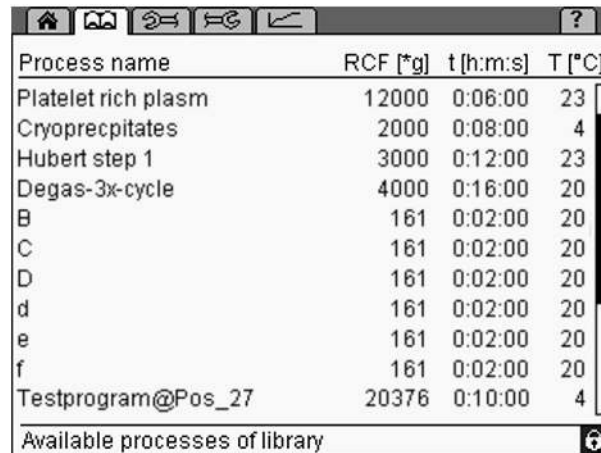

Process name	RCF [*g]	t [h:m:s]	T [°C]
Platelet rich plasm	12000	0:06:00	23
Cryoprecipitates	2000	0:08:00	4
Hubert step 1	3000	0:12:00	23
Degas-3x-cycle	4000	0:16:00	20
B	161	0:02:00	20
C	161	0:02:00	20
D	161	0:02:00	20
d	161	0:02:00	20
e	161	0:02:00	20
f	161	0:02:00	20
Testprogram@Pos_27	20376	0:10:00	4

Available processes of library

Fig. 19: Process library menu

Loading a process

- In the process library, select the desired process by turning the function knob. Press the function knob in order to confirm the selection.

The process will be loaded and the "Standard" menu 🏠 will be displayed.

Starting a process

- In the process library, select the desired process by turning the function knob. Then, press the start button.

The process will be loaded and started. The "Standard" menu 🏠 will be displayed.

6 Using the centrifuge

6.3.2.7 Parameters menu

The "Parameters" menu is symbolised by the "⚙️" symbol on the menu bar. It is used to specify various conditions for the centrifugation. These conditions are used to monitor the process and to control access to the centrifuge.

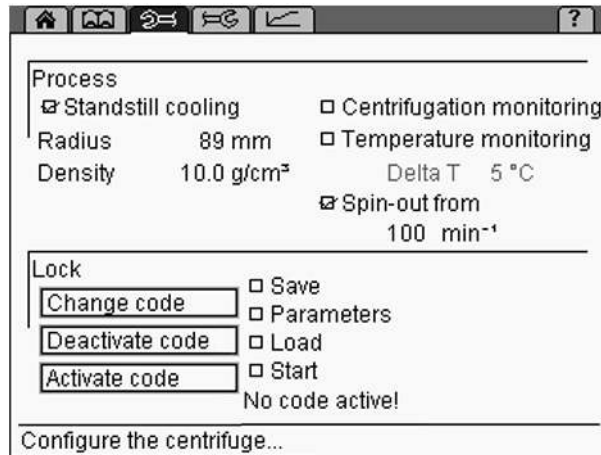

Fig. 20: Menu "Parameters"

Process

Standstill heating

Depending on the substances to be centrifuged, it may make sense to preheat the centrifuge. The preheating prevents the heated samples in the unheated centrifuge from cooling down to an inadmissible temperature level.

If the standstill heating is activated, the centrifuge starts to preheat after it is switched on. In the runtime field, the symbol "⚡" is displayed. The lid must be closed.



The centrifuge is equipped with the "RAPID_TEMP" program. This program is used to preheat the rotor chamber quickly under defined conditions (see chapter 6.3.2.5 - "Standard menu", Program list).

Radius

The radius determines the values of the relative centrifugal force (RCF) that the sample is subjected to. Normally, the maximum RCF value is displayed. If the value is reduced manually, a downward facing arrow "↓" will be displayed in the RCF field.

Density

This setting is useful for glass vessels. If the density of the liquid to be centrifuged is higher than 1.2 g/cm³, the value must be adapted manually in order to prevent the glass vessel from breaking. This will reduce the maximum possible final speed (see chapter 2.2.2.2 - "Density"). The reduction will be represented by a downward facing arrow "↓" in the speed field. Values between 1.2 and 10.0 g/cm³ are possible.

Centrifugation monitoring

The centrifugation monitoring function enables the continuous monitoring of the speed and runtime parameters during the centrifugation.

- Activate the centrifugation monitoring function by clicking.



If the function is activated during a centrifugation run, the monitoring process will not be started until the start of the next centrifugation run.

The centrifugation monitoring function compares the speed values of the current run with the reference values that are stored in the control unit. After every run, it issues a corresponding message.

The runtime is considered faulty if the centrifugation run had to be stopped prematurely.

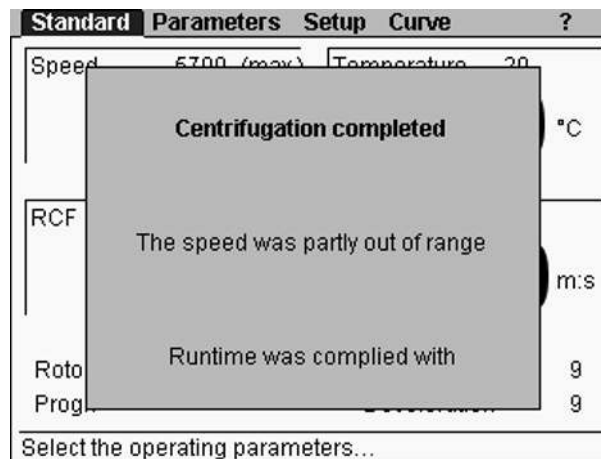

Fig. 21: Example of a centrifugation monitoring message



If the centrifugation monitoring system is used in combination with free acceleration or deceleration curves, unjustified error messages may result in certain cases.

Temperature monitoring

The control system includes a temperature monitoring function. If the actual temperature difference with regard to the set value deviates from the set temperature difference, the centrifuge will stop and an error message will be issued.

- Activate the temperature monitoring function by clicking.
- Adjust the desired "Delta T" limit value in steps of 1°C or 1°F and confirm the setting.

If the temperature monitoring function is active, the symbol "±" is displayed in the temperature field of the "Standard" menu.

In this case, the centrifuge can only be started if the current temperature is between the preset temperature in the "Standard" menu and the "Delta T" limit value.

6 Using the centrifuge

If the temperature leaves this range during the centrifugation run, an error message will be displayed and the centrifuge will be decelerated to a complete standstill.



The delta T temperature monitoring system remains inactive as long as the "RAPID_TEMP" program is active (see chapter 6.3.2.5 - "Standard menu", "Program "RAPID_TEMP"").

Spin-out from...

If this function is active, the brake will be deactivated when the actual speed is below the set speed. As a result, the rotor will spin out in a brakeless manner.



A spin-out, in particular with heavy rotors and at high speeds, can take a lot of time! (Depending on the rotor and load, the speed will be reduced by approximately 0.5 to 1 rpm per second.)

If the spin-out is active, "+0" is displayed next to the deceleration curve.

- The spin-out can be interrupted by a quick stop or by restarting the centrifuge.

Lock

In order to prevent any unauthorised use of the centrifuge, the following functions can be blocked:

- Saving of programs (level 01)
- Changing of parameters, short run (level 02)
- Loading of programs (level 03)
- Start button (level 04)

Blocking a function

- Select the function that is to be blocked. The lower levels will also be automatically selected (if, for example, the "Parameters" function is selected, the "Save" function will also be selected).
- Select the button "Activate code".
- Enter a four-digit code and confirm the entry.

The lock is now active. The symbol "🔒" will be displayed in the status line and the lock level will be indicated.

If changes are made after a function has been blocked, the system will ask for the code prior to executing the change.

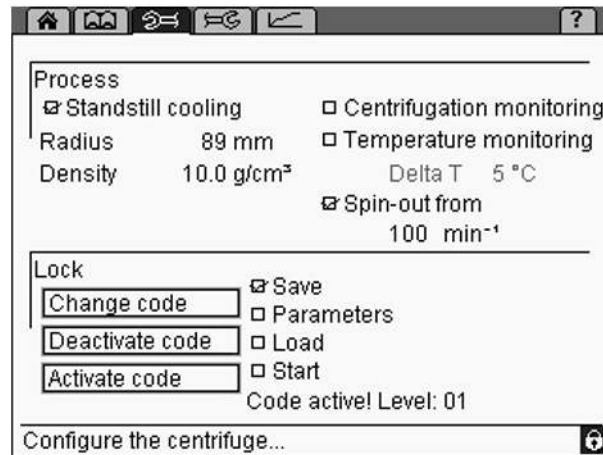

Fig. 22: "Parameters" menu with an active lock (level 01)

Unblocking a function

- Select the button "Deactivate code".
- Enter the code and confirm the entry.

The lock is now deactivated.

Changing the code

- Select the button "Change code".
- Enter the old code and confirm the entry.
- Enter the new code.
- For safety reasons, the code must be entered a second time.

The code is now changed.

6 Using the centrifuge

6.3.2.8 Setup menu

The "Setup" menu is symbolised by the "⚙️" symbol on the menu bar. It is used to perform basic settings concerning the control system of the centrifuge. It enables the optimum adaptation of the centrifuge to its specific area of application.

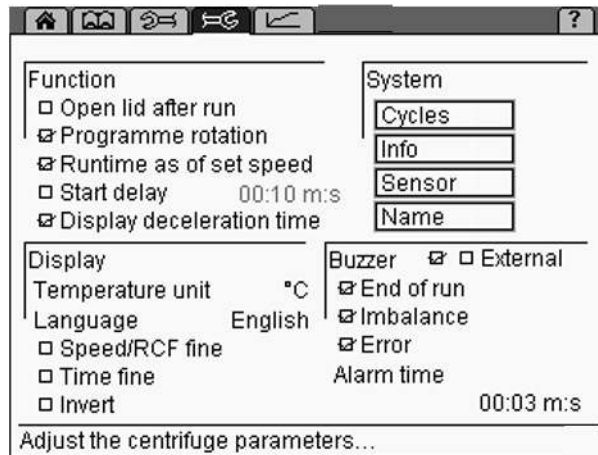

Fig. 23: Menu "Setup"

Function

Open lid after run

The automatic lid opening function ensures that the lid opens when the rotor has stopped.



CAUTION

When the lid is open, the cooling is not active. The sample may warm up!

Program rotation

See chapter 6.3.3.5 - "Automatic program rotation".

Runtime as of set speed

If this function is active, the runtime will not be measured until the set speed is reached. In the "Standard" menu, the symbol "⌚!" will be displayed in the runtime field.



NOTE

In the program mode, this function can be saved separately for every program. In this case, the symbol "⌚!" will be displayed under the runtime of the detailed program description.

6 Using the centrifuge

Start delay

If the start delay function is active, the centrifuge will not start until the preset time has elapsed. The symbol "⌚" will be displayed in the runtime field.

Display deceleration time

In the activated mode, the deceleration time will be displayed instead of the runtime during and after the deceleration process. Below the time display, the symbol "⏻" will be displayed. During a deceleration process, the symbol flashes. Once the deceleration is complete, it is displayed in a permanent manner.

Display

Temperature unit

The temperature can be displayed in °C (Celsius) or °F (Fahrenheit).

Language

The control system can be used in various language versions.

If a language is selected by mistake, it can be changed on any screen as follows:

- Press and hold the stop button.
- Turn the function knob one notch to the left and then one notch to the right.
- Release the stop button. The "Language" window will be displayed.
- Select the desired language.

Speed/RCF fine and Time fine

This menu item can be used to preselect the set speed in steps of 1 rpm (instead of 100 rpm), the RCF value in steps of 1 x g (instead of 10 x g), and the set time in steps of 1 min or 1 sec (instead of 10 min or 10 sec).



Regardless of the fine adjustment, the step size increases when the function knob is turned quickly.

Invert

If this function is activated, the display switches from the standard setting with a bright background and dark writing to a dark background with bright writing.

6 Using the centrifuge

System

Cycles

This field shows the number of cycles as well as the runtime of the rotor and buckets that are used.

Info

This item provides information on the software versions that are used in this centrifuge.

Sensor

The sensor mode is reserved for the service personnel.



Values can neither be entered nor changed in the menus "Cycles", "Info", and "Sensor".

Name

In this field, an identification will be assigned to the centrifuge.

- The letters and characters can be entered when the cursor flashes in the text field. Turn the function knob in order to select a character and press it to confirm the selection. Then, press the knob again in order to enter the next character. Pressing the arrow button ← will delete the last character. The maximum number of characters is 19.
- When the name is complete, select the option "Accept" and confirm it.

Buzzer (signal)

With this function, a warning sound signal can be selected for

- the end of a centrifugation run,
- an imbalance message,
- an error message.

The duration of the warning signal can be specified.

External

This function is only available if the centrifuge is equipped with the option for the input and output of data (external signal, floating switch) (see chapter 6.3.4 - "Options for data input and output").

6.3.2.9 Curve menu

This menu is used to create and edit customised acceleration and deceleration curves (see chapter 11.3 - "Acceleration and deceleration curves"). It is symbolised by the "⏮" symbol on the menu bar.

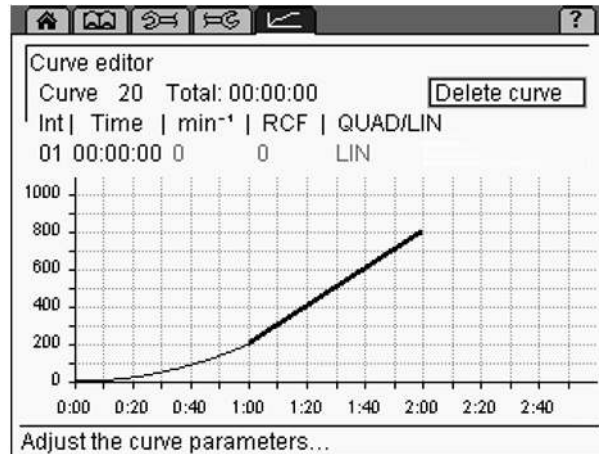

Fig. 24: Menu "Curve"

Creating or changing an acceleration curve

During a centrifugation run, curves can only be displayed. They cannot be changed or deleted.

- Select the "Curve" menu. The curve editor will be displayed.
- Select a curve number between 20 and 29 in the input field "Curve". If the curve number is already used, the stored curve will be displayed.
- The input field "Int" is used to specify the interval number of the process. Up to ten intervals can be entered for a curve.
- Enter the interval time of the current interval into the input field "Time". While doing so, certain restrictions must be taken into consideration (see below).
- Enter the desired acceleration under "min⁻¹" (rpm) or "RCF". While doing so, certain restrictions must be taken into consideration (see below). The values are interdependent.
- In the first interval, "QUAD/LIN" can be used to select a linear or quadratic rise. All of the other intervals are linear.

The field "Total" shows the total runtime of the process. The maximum total runtime of a curve depends on the slope of the curve and on the final speed of the rotor.



Only the last curve interval can be changed retroactively.

6 Using the centrifuge

Restrictions

- Acceleration and deceleration curves can include intervals with a positive slope as well as intervals with a negative slope and also intervals with 0 slope.
- The slope of the curve intervals can be 1 min⁻¹/sec (rpm/sec) minimum and 1000 min⁻¹/sec (rpm/sec) maximum.
- Quadratic curve intervals are only possible between 0 and 1000 min⁻¹ (rpm) maximum. If a final speed > 1000 min⁻¹ (rpm) is selected, this interval will automatically become linear above 1000 min⁻¹ (rpm).
- The possible runtime results from the maximum possible speed (depending on the rotor) and from the slope limitation.

Example 1: Start speed 0 min⁻¹ (rpm), final speed 100 min⁻¹ (rpm), runtime 1 hour not possible, since the necessary slope < 0.03 min⁻¹ (rpm), which means that it is beyond the defined range.

Example 2: Start speed 0 min⁻¹ (rpm), final speed 15000 min⁻¹ (rpm), runtime 10 sec. not possible, since the necessary slope is 1500 min⁻¹ (rpm), which means that it is beyond the defined range.

6.3.2.10 Help menu

The help function is symbolised by the "?" symbol on the menu bar. It provides a short description of the control elements of the selected option.

Activating and deactivating the help function

- Select the question mark on the menu bar and press the function knob.
- Quit the help function by selecting the question mark and by pressing the function knob again.

Parameters can still be changed when the help function is activated.



Fig. 25: Menu "Help"

6.3.2.11 Changing the contrast

To change the contrast:

- Press and hold the stop button and turn the function knob one notch to the left. A dialog box will be displayed once the stop button is released.
- Adjust the contrast of the centrifuge display and confirm the change.

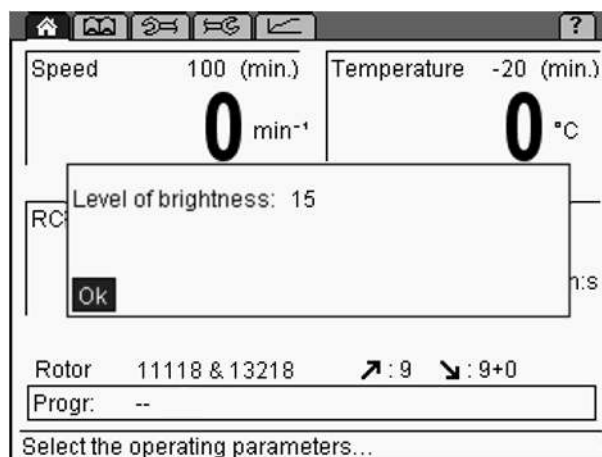

Fig. 26: Dialog box for changing the contrast

6.3.3 Program mode

A program contains all of the data that are required for a centrifuge run. Certain sedimentation results can be repeated under identical conditions. Programs can be loaded, executed, edited, and deleted when the centrifuge is at a standstill.

A maximum of 60 programs can be stored under the numbers 1-60. The program "RAPID_TEMP" does not occupy any storage location and cannot be deleted. It is used to bring the centrifuge to a specific temperature without any vessels.



"--" means that the values that are currently set are not a stored program.

The programs can be protected against unauthorised use, modification, or deletion with the aid of a code (see chapter 6.3.2.7 - "Parameters menu").

Stored programs are listed in the "Process library" menu .

6 Using the centrifuge

6.3.3.1 Saving a program

- Enter the parameters that are to be included in the program.
- Select the option "Progr" in the "Standard" menu  and confirm the selection. The program list will be displayed.
- Select a storage location from the program list.
- Save the program under the desired name. The letters and characters can be entered when the cursor flashes in the text field.
 - Turn the function knob in order to select a letter and press it to confirm the selection. Then, the next character can be selected.
 - Pressing the arrow button  will delete the last character.
- When the program name is complete, select "OK" and confirm it.

The program will be saved and the "Standard" menu will be displayed.

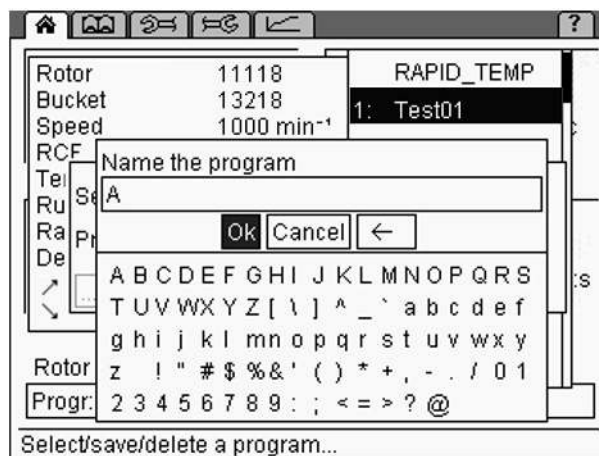



Fig. 27: Assignment of a program name prior to saving the program

6.3.3.2 Loading a program

- Select the option "Progr" from the "Standard" menu  and confirm the selection by pressing the function knob. The program list will be displayed.
- Select the desired program from the list and confirm the selection by pressing the function knob.

Or:

- Open the process library , select the desired program, and confirm the selection by pressing the function knob.

The program will be loaded and the "Standard" menu will be displayed.

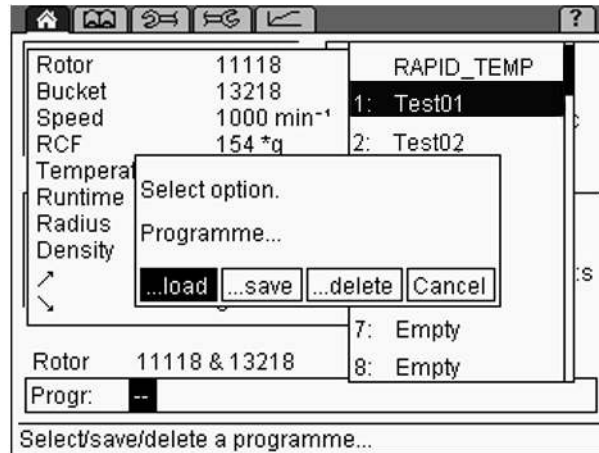



Fig. 28: Loading a program

6.3.3.3 Executing a program

- Select the option "Progr" from the "Standard" menu  and confirm the selection by pressing the function knob. The program list will be displayed.
- Select the desired program from the list and confirm the selection by pressing the function knob.
- Press the start button.

Or:

- Open the process library , select the desired program, and press the start button.

The program will be executed and the "Standard" menu will be displayed.

6.3.3.4 Deleting a program

- Select the option "Progr" in the "Standard" menu  and confirm the selection. The program list will be displayed.
- Select the program that is to be deleted.
- Select the option "Delete" and confirm it.

The program will be deleted and the "Standard" menu will be displayed.

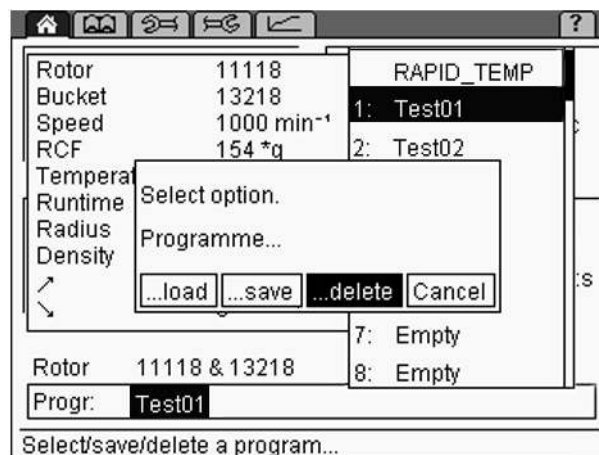



Fig. 29: Deleting a program

6 Using the centrifuge

6.3.3.5 Automatic program rotation

With the automatic program rotation, several programs can be executed directly one after the other.

- Activate the "Program rotation" function in the "Setup" menu .

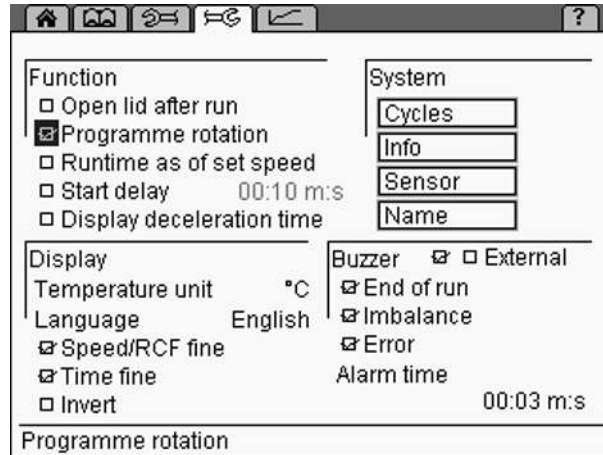

Fig. 30: Program rotation function

When a program is loaded while the program rotation function is active, this program will be used as the start program for the rotation. After the completion of the program, the next program on the program list will be loaded automatically. The rotation continues up to the next empty storage location and then restarts from the beginning (see the following illustration).

Example 1: Loading of Test04

Rotation: Test04, Test05, Test06, Test04,...

Example 2: Loading of Test05

Rotation: Test05, Test06, Test05,...

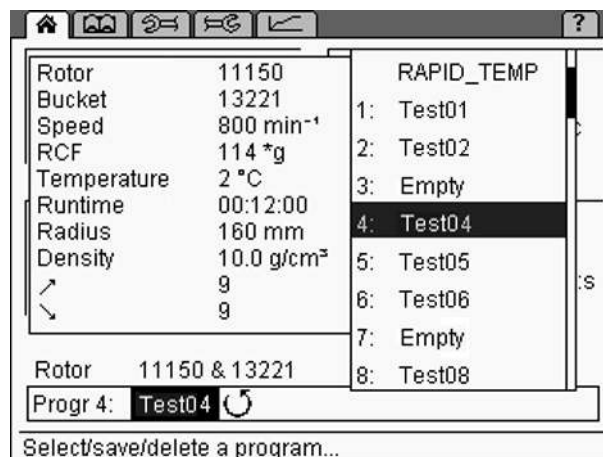

Fig. 31: Automatic program rotation

While the program rotation function is active, the arrow "↻" is displayed in the program line in the "Standard" menu.

6.3.4 Options for data input and output

- Connection for a serial interface (depending on the centrifuge type, partly standard).
- External signal active DC 24V, 0.5 A max. (part no. 17701)
- Floating switch AC 250V max., 6 A (part no. 17702)

6.4 Switching the centrifuge off

- Open the centrifuge when it is not in use so moisture can evaporate.
- Switch the centrifuge off by pressing the mains power switch.

7 Malfunctions and error correction

7 Malfunctions and error correction

7.1 General malfunctions

Malfunctions are indicated by a dialog box. If the acoustic signal is activated, it sounds when the error message is displayed.

- Eliminate the source of the problem (see table below).
- Acknowledge the error messages by pressing the lid key.



NOTE

Error messages can be eliminated by pressing the lid key. The error itself will not be eliminated, but the centrifuge can be operated again.

Type of error	Possible reason	Correction
No indication on the display	No power in the mains supply	Check fuse in the mains supply
	Power cord is not plugged in	Plug in power cord correctly
	Fuses have tripped	Reactivate temperature fuse (see chapter 5.2.1 - "Type of connection")
	Mains power switch off	Switch mains power switch on
Centrifuge cannot be started: start key LED is not illuminated	Several possible causes	Power off/on. If the error occurs again, contact service
Centrifuge cannot be started: lid key LED flashes	The lid lock is not closed correctly	Open and close the lid. If the error occurs again, contact service
Centrifuge decelerates during operation	Brief mains power failure	Press start key in order to restart the centrifuge
	System error	Power off/on. If the error occurs again, contact service
Centrifuge decelerates during operation, imbalance dialog box is displayed	<ul style="list-style-type: none"> – Improper loading – Centrifuge is inclined – Drive problem – Centrifuge was moved during run 	Balance load and restart the centrifuge. If the error occurs again, contact service
	– Ungreased load-bearing bolts	Clean and grease load-bearing bolts
Lid cannot be opened	Lid lock has not released	Unlock the lid manually (see chapter 7.1.1 - "Emergency lid release") and contact service
	Lid seal sticks	Clean the lid seal and apply talcum powder
Temperature value cannot be reached (only for refrigerated centrifuges)	Condenser dirty (only air-cooled units)	Clean the condenser. If the error occurs again, contact service
Hard running noise during the centrifugation	Screws of the transport safety device are not removed	Remove screws of the transport safety device (see chapter 4.5 - "Transport safety device")

7 Malfunctions and error correction

7.1.1 Emergency lid release

In the event of a power failure, it is possible to manually open the centrifuge lid.

- Switch off the mains power switch and disconnect the power cord from the socket.
- Remove the plugs (see figure, item 1) from the opening on the left and on the right side of the control panel, e.g. with a screwdriver.



Fig. 32: Position of the openings for the emergency lid release

- Insert the supplied hexagon socket key horizontally into the hole. The key will be guided through a funnel-shaped tube to the shaft of the lid lock motor.

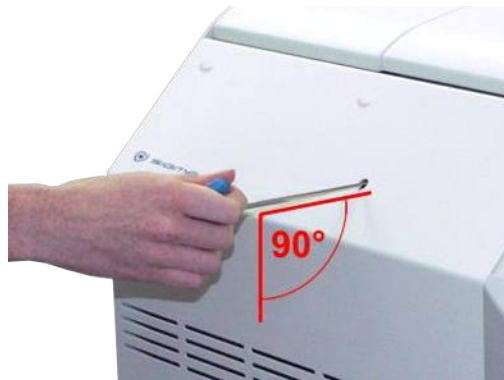

Fig. 33: The emergency lid release key must be inserted horizontally

- Unlock the motorised lid locks as follows:
 - Turn the left lid lock anti-clockwise.
 - Turn the right lid lock clockwise.
- Then, reinsert the plugs.



WARNING

Do not unlock or open the lid unless the rotor is at a standstill.

If the lid is opened via the emergency lid release system during a centrifuge run, the centrifuge will be switched off immediately and decelerate in an unbraked manner.

7 Malfunctions and error correction

7.2 Table of error codes

Error no.	Kind of error	Measures	Note
1-9	System error	<ul style="list-style-type: none"> Allow to slow down Power off/on 	All these errors stop the centrifuge or cause it to decelerate brakeless
10-19	Speedometer error	<ul style="list-style-type: none"> Allow to slow down Power off/on 	
20-29	Motor error	<ul style="list-style-type: none"> Power off Ensure ventilation 	
30-39	EEPROM error	<ul style="list-style-type: none"> Allow to slow down Power off/on 	With error 34, 35, and 36, the centrifuge will stop; with error 37 and 38 only an error message will be given
40-45	Temperature error (only for refrigerated centrifuges)	<ul style="list-style-type: none"> Allow to slow down Power off Allow to cool down Provide better ventilation (only air cooled centrifuges) Provide sufficient water throughput (only water cooled centrifuges) 	
46-49	Imbalance error (only for centrifuges with imbalance monitoring system)	<ul style="list-style-type: none"> Allow to slow down Power off Eliminate the imbalance 	
50-59	Lid error	<ul style="list-style-type: none"> Press lid key Close lid Remove foreign matter from the opening of the lid lock device 	With error 50 and 51, the centrifuge will stop
60-69	Process error	<ul style="list-style-type: none"> Allow to slow down Power off/on 	With error 60, the message "power failure during run" will be displayed, with error 61, the message "stop after power on" will be displayed
70-79	Communication error	<ul style="list-style-type: none"> Allow to slow down Power off/on 	
80-89	Parameter error	<ul style="list-style-type: none"> Power off Allow to cool down Provide for better ventilation 	With error 83, error message only
90-99	Other errors	<ul style="list-style-type: none"> Check connections Provide sufficient water throughput (only water cooled centrifuges) 	



If it is impossible to eliminate the errors, contact the service!

7.3 Service contact

In the event of queries, malfunctions, or spare part enquiries:

From Germany:

Contact

Sigma Laborzentrifugen GmbH
An der Unteren Söse 50
37520 Osterode (Germany)
Tel. +49 (0) 55 22 / 50 07-44 44
E-mail: support.lab@sigma-zentrifugen.de

Outside Germany:

Contact our agency in your country. All agencies are listed at
www.sigma-zentrifugen.de → [Sales Partners]



- If you would like to utilise our service, please state the type of your centrifuge and its serial number.

8 Maintenance and service

8 Maintenance and service

The centrifuge, rotor, and accessories are subject to high mechanical stress. Thorough maintenance performed by the user extends the service life and prevents premature failure.



CAUTION

If corrosion or other damage occurs due to improper care, the manufacturer cannot be held liable or subject to any warranty claims.

- Use soap water or other water-soluble, mild cleaning agents with a pH value between 6 and 8 for cleaning the centrifuge and accessories (see also chapter 8.2 - "Sterilisation and disinfection of the rotor chamber and accessories").
- Avoid corrosive and aggressive substances.
- Do not use solvents.
- Do not use agents with abrasive particles.
- Do not expose the centrifuge and rotors to intensive UV radiation or thermal stress (e.g. by heat generators).

8.1 Maintenance

8.1.1 Centrifuge

- Unplug the mains power plug before cleaning.
- Carefully remove all liquids, including water and particularly all the solvents, acids, and alkaline solutions from the rotor chamber using a cloth in order to avoid damage to the motor bearings.
- If the centrifuge has been contaminated with toxic, radioactive, or pathogenic substances, clean the rotor chamber immediately with a suitable decontamination agent (depending on the type of contamination).



WARNING

Take suitable precautions for your own safety if there is a risk of toxic, radioactive, or pathogenic contamination.

- After every cleaning process, grease the motor shaft slightly with a small amount of heavy-duty grease for load-bearing bolts (part no. 71401) and distribute the grease with a cloth so that it forms a thin layer.

8.1.2 Accessories**CAUTION**

For the care of the accessories, special safety measures must be considered as these are measures that will ensure operational safety at the same time!

- Immediately rinse off the rotor, buckets, or accessories under running water if they have come into contact with any liquids that may cause corrosion. Use a brush for test tubes in order to clean the bores of angle rotors. Turn the rotor upside down and allow it to dry completely.
- Clean the accessories outside the centrifuge once a week or preferably after each use. Adapters should be removed, cleaned and dried.

**CAUTION****Do not clean the accessories in a dishwasher!**

Cleaning in a dishwasher removes the anodised coating; the result is cracking in areas that are subject to stress.

- If the rotors or accessories have been contaminated with toxic, radioactive, or pathogenic substances, clean them immediately with a suitable decontamination agent (depending on the type of contamination). Take suitable precautions for your own safety if there is a risk of toxic, radioactive, or pathogenic contamination.
- Dry the accessories with a soft cloth or in a drying chamber at approx. 50°C.

8.1.2.1 Plastic accessories

The chemical resistance of plastic decreases with rising temperatures (see chapter 11.5 - "Resistance data").

- If solvents, acids, or alkaline solutions have been used, clean the plastic accessories thoroughly.

**WARNING**

Plastic accessories must not be greased!

8 Maintenance and service

8.1.3 Rotors, buckets and carriers

Rotors, buckets and carriers are produced with the highest precision, in order to withstand the permanent high stress from high gravitational fields. Chemical reactions as well as stress-corrosion (combination of oscillating pressure and chemical reaction) can affect or destroy the metals. Barely detectable cracks on the surface can expand and weaken the material without any visible signs.

- Check the material regularly (at least once a month) for
 - cracks
 - visible damage of the surface
 - pressure marks
 - signs of corrosion
 - other changes.

- Check the bores of the rotors and multiple carriers.
- Replace any damaged components immediately for your own safety.
- After every cleaning process, grease the rotor tie-down screw slightly with a small amount of heavy-duty grease for load-bearing bolts (part no. 71401) and distribute the grease with a cloth so that it forms a thin layer.

8.1.4 Load bearing bolts

Only greased load-bearing bolts ensure a uniform swing-out of the buckets and, therefore, the smooth operation of the centrifuge. Load-bearing bolts that are insufficiently greased may cause the centrifuge to stop due to an imbalance.

- Clean the load-bearing bolts and bucket groove in order to remove the old grease.
- Apply a small amount of heavy-duty grease for load-bearing bolts (ref. no. 71401, see the following picture) to both load-bearing bolts of a bucket.



Fig. 34: Sufficient quantity of grease for one bolt

- Install the bucket and swing it manually back and forth once in order to distribute the grease.
- Repeat this process with all the other buckets.

8 Maintenance and service

8.1.5 Glass breakage



CAUTION

In the case of glass breakage, immediately remove all glass particles (e.g. with a vacuum cleaner). Replace the rubber cushions since even thorough cleaning will not remove all glass particles.

Glass particles will damage the surface coating (e.g. anodising) of the buckets, which will then lead to corrosion.

Glass particles in the rubber cushions of the buckets will cause glass breakage again.

Glass particles on the pivot bearing of the load-bearing bolts prevent the buckets and carriers from swinging evenly, which will cause an imbalance.

Glass particles in the rotor chamber will cause metal abrasion due to the strong air circulation. This metal dust will not only pollute the rotor chamber, rotor, and materials to be centrifuged but also damage the surfaces of the accessories, rotors, and rotor chamber.

In order to completely remove the glass particles and metal dust from the rotor chamber:

- Grease the upper third of the rotor chamber with e.g. Vaseline.
- Then, let the rotor rotate for a few minutes at a moderate speed (approx. 2000 rpm). The glass and metal particles will now collect at the greased part.
- Remove the grease with the glass and metal particles with a cloth.
- If necessary, repeat this procedure.

8.2 Sterilisation and disinfection of the rotor chamber and accessories

- Use commercially-available disinfectants such as, for example, Sagrotan[®], Buraton[®], or Terralin[®] (available at chemist's shops or drugstores).
- The centrifuge and the accessories consist of various materials. A possible incompatibility must be considered.
- Before using cleaning or decontamination agents that were not recommended by us, contact the manufacturer to ensure that such a procedure will not damage the centrifuge.
- For autoclaving, consider the continuous heat resistance of the individual materials (see chapter 8.2.1 - "Autoclaving").

Please contact us if you have any queries (see chapter 7.3 - "Service contact").



DANGER

If dangerous materials (e.g. infectious and pathogenic substances) are used, the centrifuge and accessories must be disinfected.

8.2.1 Autoclaving

The service life of the accessories essentially depends on the frequency of autoclaving and use.

- Replace the accessories immediately when the parts show changes in colour or structure or in the occurrence of leaks etc.
- During autoclaving, the caps of the tubes must not be screwed on in order to avoid the deformation of the tubes.

NOTE

It cannot be excluded that plastic parts, e.g. lids or carriers, may deform during autoclaving.

Accessories	Max. temp. (°C)	Min. time (min)	Max. time (min)	Max. cycles
Aluminium buckets	134-138	3	5	-
Aluminium rotors	134-138	3	5	-
Glass tubes	134-138	3	40	-
Polyallomer / polycarbonate rectangular carriers	115-118	30	40	-
Polyallomer / polycarbonate round carriers	115-118	30	40	-
Polyamide buckets	115-118	30	40	10
Polycarbonate / polyallomer lids for angle rotors	115-118	30	40	20
Polycarbonate tubes	115-118	30	40	20
Polyphenylsulfone (PPSU) caps for buckets	134-138	3	5	100
Polypropylene balance adapter for blood-bag systems	115-118	30	40	n.s.
Polypropylene copolymer tubes	115-121	30	40	20
Polypropylene rectangular carriers	115-118	30	40	-
Polypropylene rotors	115-118	30	40	20
Polypropylene round carriers	115-118	30	40	-
Polysulfone caps for buckets	134-138	3	5	100
Polysulfone lids for angle rotors	134-138	3	5	100
Rubber adapters	115-118	30	40	-
Stainless-steel balance weight for blood-bag systems	121	30	30	n.s.
Teflon tubes	134-138	3	5	100

8 Maintenance and service

8.3 Service



DANGER

In the event of service work that requires the removal of the panels, there is a risk of electric shock or mechanical injury.

- Only qualified specialist personnel is authorised to perform this service work.
- Following the completion of any type of service, the qualified and specialised personnel must perform final inspection and testing in compliance with the relevant standards.

The centrifuge is subject to high mechanical stress. In order to be able to withstand this high level of stress, high-quality components were used during the production of the centrifuge. Nevertheless, wear cannot be excluded and it may not be visible from the outside. Especially the rubber parts that are – among other things – part of the motor suspension, are subject to ageing.

This is why we recommend having the centrifuge checked by the manufacturer during an inspection once per year in the operating state and once every three years in the dismantled state. Rubber parts should be replaced after three years.

Information and appointments:

In Germany:

Contact

Sigma Laborzentrifugen GmbH

An der Unteren Söse 50

37520 Osterode (Germany)

Tel. +49 (0) 55 22 / 50 07-44 44

E-mail: support.lab@sigma-zentrifugen.de

Outside Germany:

Contact our agency in your country. All agencies are listed at www.sigma-zentrifugen.de → [Sales Partners]



NOTE

- If you would like to utilise our service, please state the type of your centrifuge and its serial number.

8.4 Return of defective centrifuges or parts

Although we exercise great care during the production of our products, it may be necessary to return a unit or accessory to the manufacturer.

In order to ensure the quick and economical processing of returns of centrifuges, spare parts, or accessories, we require complete and extensive information concerning the process. Please fill in the following forms completely, sign them, enclose them with the return package, and send them together with the product to:

Sigma Laborzentrifugen GmbH
An der Unteren Söse 50
37520 Osterode (Germany)

1. Declaration of decontamination

As a certified company and due to the legal regulations for the protection of our employees and of the environment, we are obliged to certify the harmlessness of all incoming goods. For this purpose, we require a declaration of decontamination.

- The form must be filled in completely and signed by authorised and specialised personnel only.
- Affix the original form in a clearly visible manner to the outside of the packaging.



NOTE

We will return the part/unit if no declaration of decontamination is provided!

2. Form for the return of defective parts

This form is for the product-related data. They facilitate the assignment, and they enable the quick processing of the return. If several parts are returned together in one packaging, please enclose a separate problem description for every defective part.

- A detailed problem description is necessary in order to perform the repair quickly and economically.



NOTE

If the form does not include a description of the malfunction, neither a refund nor a credit note can be issued. In this case, we reserve the right to return the part/unit to you at your expense.

- Upon request, we will prepare and submit to you a cost estimate prior to performing the repair. Please confirm such cost estimate within 14 days. If the cost estimate has still not been confirmed after 4 weeks, we will return the defective part/unit. Please note that you must bear the incurred costs.

8 Maintenance and service



The defective part/unit must be packaged in a transport-safe manner. Please use the original packaging for the unit, if at all possible. If the product is dispatched to us in unsuitable packaging, you will be charged the cost for returning it to you in new packaging.

The forms can be downloaded online from
www.sigma-zentrifugen.de → [Service] → [Overhaul and repair].

9 Disposal

9.1 Disposal of the centrifuge



In accordance with the directive 2012/19/EU, SIGMA centrifuges are marked with the symbol shown to the left. This symbol means that it is not permissible to dispose of the unit among household waste.

- You can return these centrifuges free of cost to Sigma Laborzentrifugen GmbH.
- Ensure that the unit is decontaminated. Fill in a declaration of decontamination (see chapter 8.4 - "Return of defective centrifuges or parts").
- Comply with any other applicable local rules and regulations.

9.2 Disposal of the packaging

- Use the packaging to return the centrifuge for disposal or
- dispose of the packaging, after having separated the individual materials.
- Comply with all local rules and regulations.

10 Technical data

10 Technical data

Manufacturer:	Sigma Laborzentrifugen GmbH An der Unteren Söse 50 37520 Osterode (Germany)
Type:	6-16HS
<u>Connection requirements</u>	
Electr. connection:	see name plate
Protection class:	I
IP code:	20
Power consumption (kW):	2.0
Input fuse (AT):	16.0 (at 220-240 V / 50 Hz), temperature fuses
<u>Performance data</u>	
Max. speed (rpm):	13,500
Max. capacity (ml):	3,200
Max. gravitational field (x g):	20,376
Max. kinetic energy (Nm):	106,950
<u>Other parameters</u>	
Time range:	10 sec – 99 h 59 min, short run, continuous run
Temperature range:	-20°C to +70°C
Storage locations:	60
<u>Physical data</u>	
Height (mm):	483
Height with open lid (mm):	990
Width (mm):	581
Depth (mm):	711
Weight (kg):	116
Noise level (dB(A)):	< 73 (at maximum speed)

10.1 Ambient conditions

- The figures are valid for an ambient temperature of +23°C and a nominal voltage $\pm 10\%$.



At a nominal voltage of 100V or 200V, a tolerance of +10% / -5% applies.

- For indoor use only.
- Allowable ambient temperature +5°C to +40°C.
- Max. allowable relative humidity of air 80% from 5°C up to 31°C with a linear decrease to 50% relative humidity of air at 40°C.
- Maximum altitude 2,000 m above sea level.

10.2 Technical documentation

For environmental reasons, the comprehensive technical documentation of the centrifuge (e.g. circuit diagrams) and the safety data sheets of the manufacturers of refrigerants and lubricants are not attached to this documentation.

You can order these documents from our service department.

11 Appendix

11 Appendix

11.1 Range of accessories

The complete list of accessories can be downloaded from www.sigma-zentrifugen.de.



Some accessories come supplied together with a data sheet that includes important information and notes on safety. This data sheet must be added to the operating manual.

11.1.1 Rotor radii

The information in the accessories table concerning the radius refers to the values of the respective rotor as shown below. The radius calculation is described in chapter 2.2.2.1 - "Speed, radius, and relative centrifugal force".

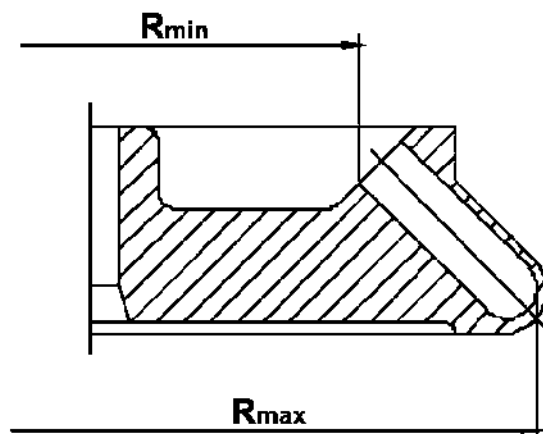

Fig. 35: Minimum and maximum radius of an angle rotor

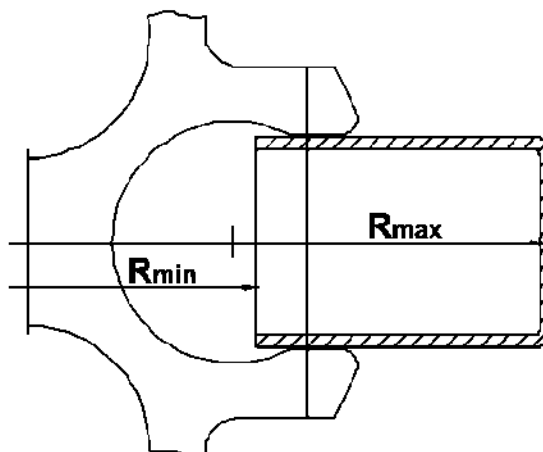

Fig. 36: Minimum and maximum radius of a swing-out rotor

11.2 Speed-gravitational-field-diagram

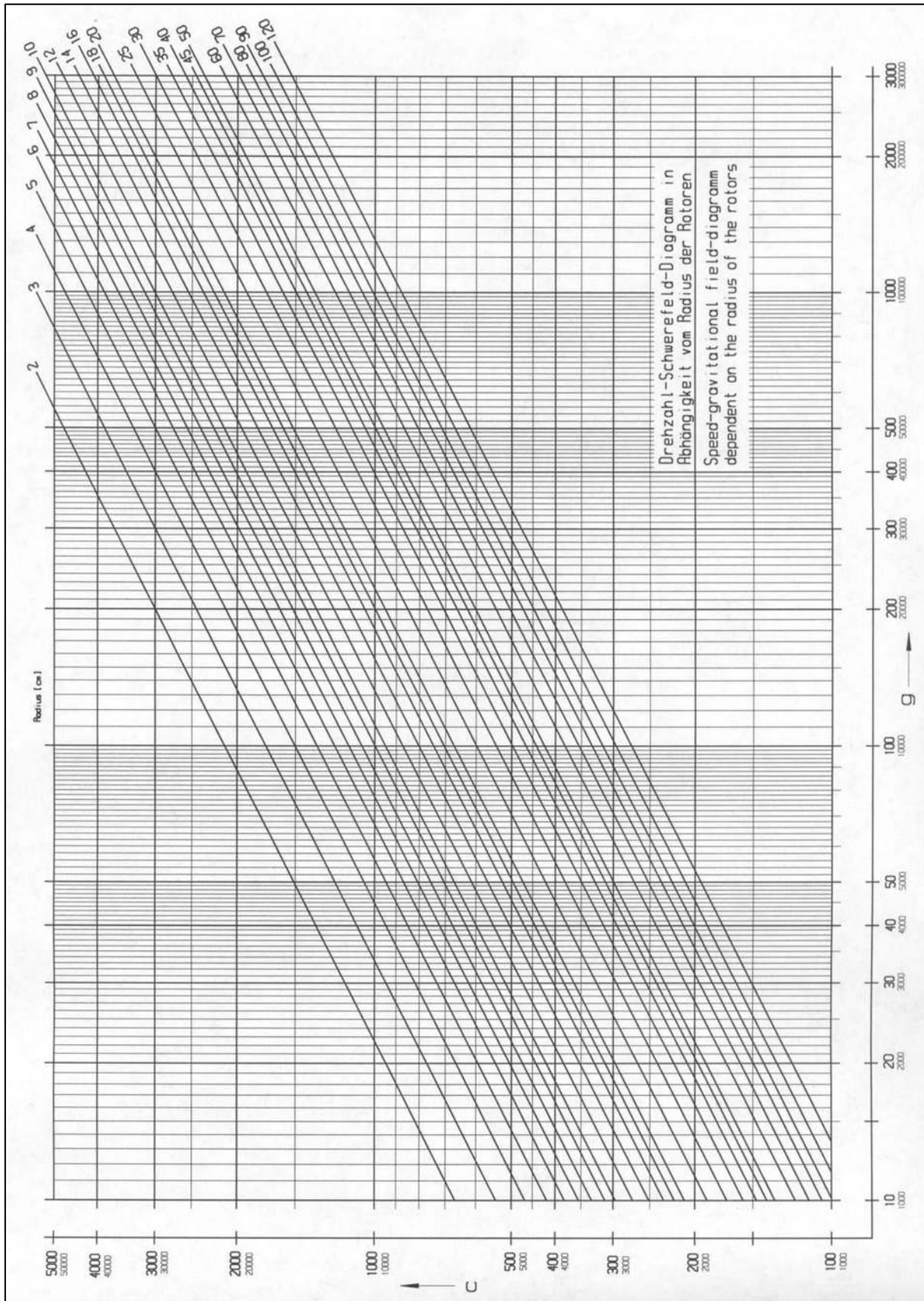

Fig. 37: Speed-gravitational-field-diagram

11 Appendix

11.3 Acceleration and deceleration curves

Linear as well as quadratic curves are numbered in the direction of increasing acceleration (from right to left).

The deceleration curves are inverted images of the acceleration curves and are assigned the same numbers. An exception is curve 0. It decelerates brakeless (spin-out).

In general, the runtime, until the set speed is reached, depends on the moment of inertia of the rotor.

Linear curves

The slope of the fixed acceleration curves defines the time that is required to accelerate the rotor by 1,000 rpm.

Curve 9 is a special case compared to the other curves. The centrifuge accelerates with maximum power. The runtime, until the set speed is reached, depends solely on the moment of inertia of the rotor.

Linear curve no.	Slope
0	4 [rpm/sec]
1	6 [rpm/sec]
2	8 [rpm/sec]
3	17 [rpm/sec]
4	25 [rpm/sec]
5	33 [rpm/sec]
6	50 [rpm/sec]
7	100 [rpm/sec]
8	200 [rpm/sec]
9	1.000 [rpm/sec]

Fig. 38: Slope of linear curves

Quadratic curves

Curve 19 is a special case compared to the other curves. The centrifuge accelerates with maximum power. The runtime depends solely on the moment of inertia of the rotor.

Quadratic curve no.	Time until 1,000 rpm	Slope as of 1,000 rpm
10	500 sec	4 [rpm/sec]
11	333 sec	6 [rpm/sec]
12	250 sec	8 [rpm/sec]
13	118 sec	17 [rpm/sec]
14	80 sec	25 [rpm/sec]
15	60 sec	33 [rpm/sec]
16	40 sec	50 [rpm/sec]
17	20 sec	100 [rpm/sec]
18	10 sec	200 [rpm/sec]
19	2 sec	1.000 [rpm/sec]

Fig. 39: Slope of quadratic curves

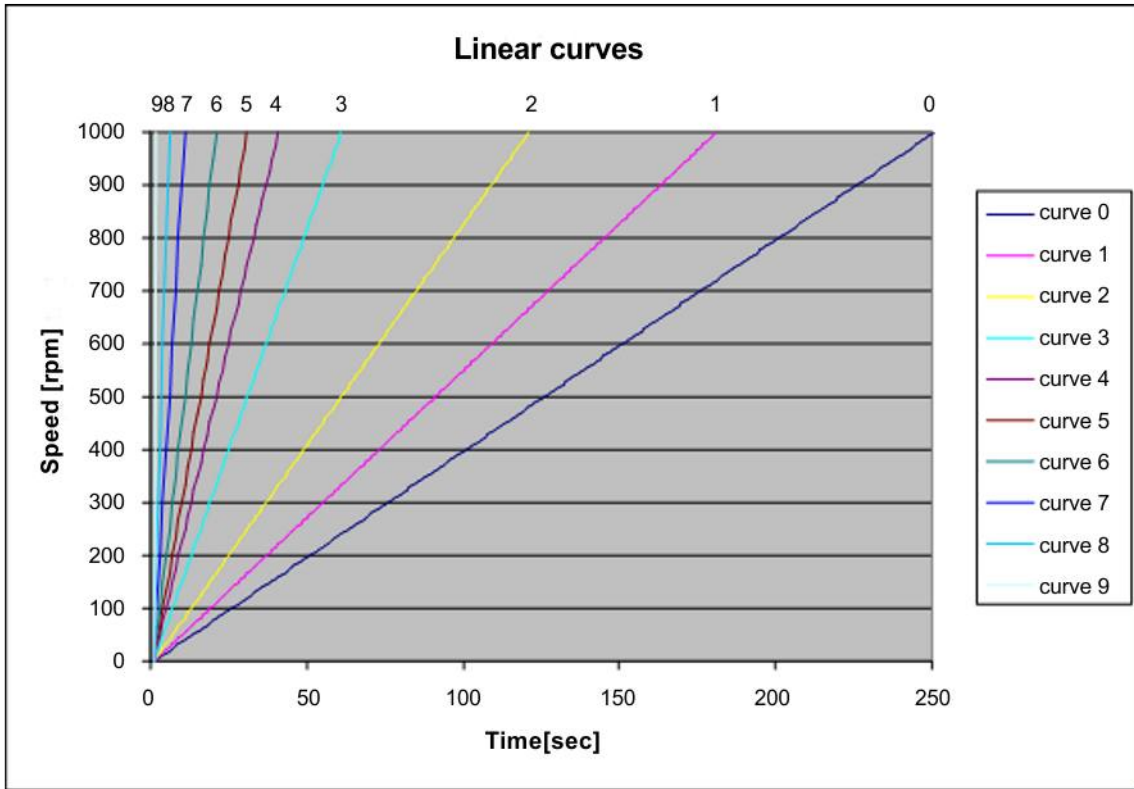

Fig. 40: Diagram of linear curves

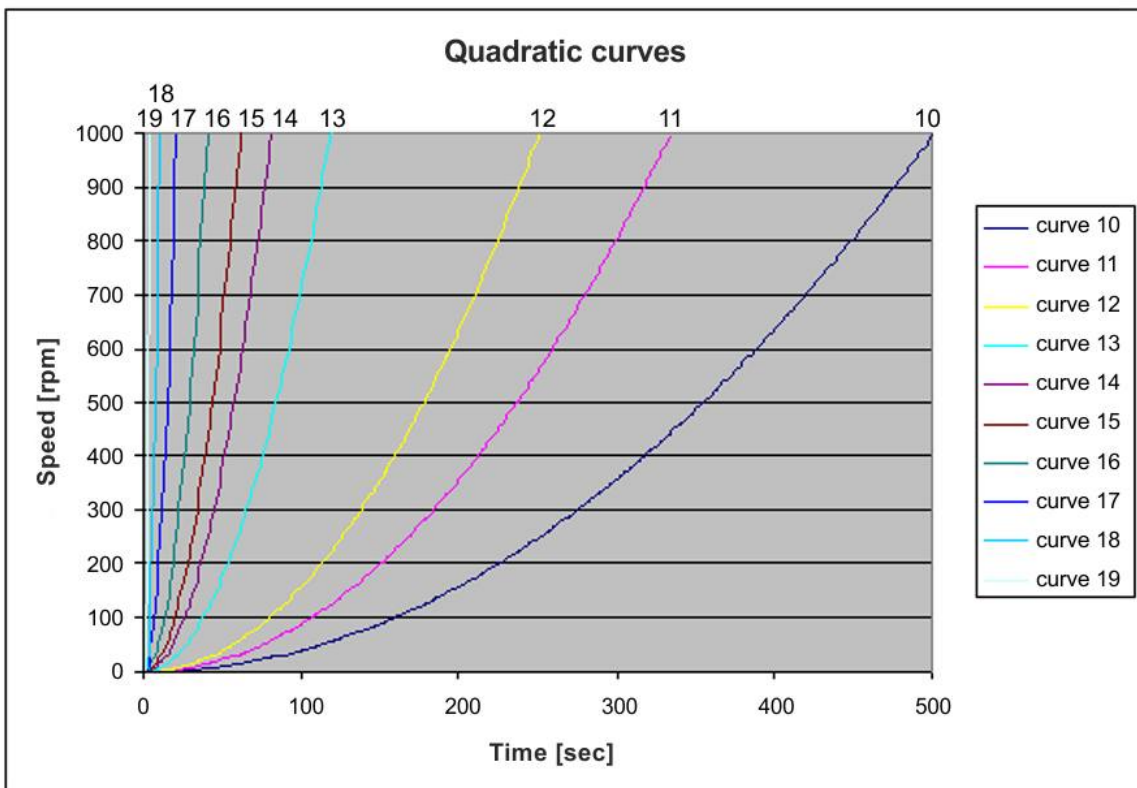

Fig. 41: Diagram of quadratic curves

11 Appendix

11.4 Table of the service life of rotors and accessories

- If no other data concerning the service life are engraved on the rotor or accessory, rotors and buckets must be checked by the manufacturer after 10 years.
- If a specification concerning the maximum number of cycles **and** a specification concerning the service life (i.e. a date) are provided, the specification that occurs first shall apply.
- After 50,000 cycles, rotors must be scrapped for safety reasons.

Rotor / bucket	Cycles	Service life ("Exp.Date")	Autoclaving	Suitable for centrifuge	Remarks
9100	15,000			4-15C, 4K15C, 4-16, 4-16S, 4-16K, 4-16KS, 6-15, 6K15, 6-16, 6-16K	without engraving, only "spincontrol professional" and "spincontrol S"
11026		7 years		1-14, 1-14K	
11805 / 13850	10,000	10 years		8K, 8KB, 8KS, 8KBS	
11805 / 13860	10,000	10 years		8K, 8KB, 8KS, 8KBS	
11806		10 years		8K, 8KB, 8KS, 8KBS	
12033		5 years		1-16 Edition, 1-16K Edition	
12082		7 years		1-14, 1-14K	
12083		7 years		1-14, 1-14K	
12084		7 years		1-14, 1-14K	
12085		7 years		1-14, 1-14K	
12092		5 years	20x	1-14, 1-14K	
12093		5 years	20x	1-14, 1-14K	
12094		5 years	20x	1-14, 1-14K	
12096		5 years	20x	1-14, 1-14K	
12097		5 years	20x	1-14, 1-14K	
12101		5 years	20x	1-15, 1-15K, 1-15P, 1-15PK	
12124		5 years	20x	1-15, 1-15K, 1-15P, 1-15PK	
12126		5 years	20x	1-15, 1-15K, 1-15P, 1-15PK	
12134		5 years	20x	1-16, 1-16K	
12135		5 years	20x	1-16, 1-16K	
12137		5 years	20x	1-16, 1-16K	
12500		7 years		6-15, 6K15, 6-16, 6-16K	
12600		7 years		6-16S, 6-16KS	
13218	20,000			4-16, 4-16S, 4-16K, 4-16KS, 6-16, 6-16S, 6-16K, 6-16KS	
13296	35,000	5 years	10x	2-6, 2-6E, 2-7, 2-16P, 2-16KL, 2-16KHL	
13299		5 years	10x	2-6, 2-6E, 2-7, 2-16P, 2-16KL, 2-16KHL	
13635	25,000			6-16, 6-16K, 6-16S, 6-16KS	
13650	20,000			4-5L, 4-16S, 4-16KS, 4-16KHS, 6-16S, 6-16HS, 6-16KS, 6-16KHS	
13845	20,000			8K, 8KB, 8KS, 8KBS	
13850	10,000*	10 years		8K, 8KB, 8KS, 8KBS	*in combination with rotor 11805
13860	15,000*	10 years		8K, 8KB, 8KS, 8KBS	*in combination with rotor 11805
13864	1,000			8K, 8KB, 8KS, 8KBS	without engraving
13865	1,000			8K, 8KB, 8KS, 8KBS	without engraving
13866	1,000			8K, 8KB, 8KS, 8KBS	without engraving
13867	2,500			8K, 8KB, 8KS, 8KBS	without engraving
13868	5,000			8K, 8KB, 8KS, 8KBS	without engraving
13869	5,000			8K, 8KB, 8KS, 8KBS	without engraving
13870	5,000			8K, 8KB, 8KS, 8KBS	without engraving

11.5 Resistance data



The data refer to resistance at 20°C.

- no data 1 resistant 2 practically resistant 3 partially resistant 4 not resistant	Medium	Formula	Concentration [%]	High Density Polyethylene	Polyamide	Polycarbonate	Polyoxymethylene	Polypropylene	Polysulfone	Polyvinyl chloride, hard	Polyvinyl chloride, soft	Polytetrafluorethylene	Acrylonitrile-butadiene- caoutchouc	Aluminium
				HDPE	PA	PC	POM	PP	PSU	PVC	PVC	PTFE	NBR	AL
	Acetaldehyde	C ₂ H ₄ O	40	3	2	4	2	3	4	4	-	1	4	1
	Acetamide	C ₂ H ₅ NO	saturated	1	1	4	1	1	4	4	-	1	-	1
	Acetone	C ₃ H ₆ O	100	1	1	4	1	1	4	4	-	1	4	1
	Acrylonitrile	C ₃ H ₃ N	100	1	1	4	3	3	4	4	4	1	4	1
	Allyl alcohol	C ₃ H ₆ O	96	1	3	3	2	2	2	2	4	1	1	1
	Aluminium chloride	AlCl ₃	saturated	1	3	2	4	1	-	1	-	1	1	4
	Aluminium sulfate	Al ₂ (SO ₄) ₃	10	1	1	1	3	1	1	1	1	1	1	1
	Ammonium chloride	(NH ₄)Cl	aqueous	1	1	1	2	1	1	1	1	1	1	3
	Ammonium hydroxide	NH ₃ + H ₂ O	30	1	3	4	1	1	2	1	-	1	-	1
	Aniline	C ₆ H ₇ N	100	1	3	4	1	2	4	4	4	1	4	1
	Anisole	C ₇ H ₈ O	100	3	4	4	1	4	4	2	-	1	4	1
	Antimony trichloride	SbCl ₃	90	1	4	1	4	1	-	1	-	1	-	4
	Benzaldehyde	C ₇ H ₆ O	100	1	3	4	1	1	3	4	4	1	4	1
	Benzene	C ₆ H ₆	100	3	2	4	1	3	4	4	-	1	4	1
	Boric acid	H ₃ BO ₃	aqueous	1	3	1	2	1	-	-	-	1	1	1
	Butyl acrylate	C ₇ H ₁₂ O ₂	100	1	2	4	2	3	4	4	4	1	-	1
	Butyl alcohol, normal	C ₄ H ₁₀ O	100	1	1	2	1	1	2	2	4	1	1	1
	Calcium chloride	CaCl ₂	alcoholic	1	4	2	3	1	-	-	4	1	1	3
	Carbon disulfide	CS ₂	100	4	3	4	2	4	4	4	4	1	3	1
	Carbon tetrachloride (TETRA)	CCl ₄	100	4	4	4	2	4	4	4	4	1	3	1
	Chlorine	Cl ₂	100	4	4	4	4	4	4	4	4	1	-	3
	Chlorine water	Cl ₂ x H ₂ O		3	4	4	4	3	-	3	3	1	-	4
	Chlorobenzene	C ₆ H ₅ Cl	100	3	4	4	1	3	4	4	4	1	4	1
	Chloroform	CHCl ₃	100	3	3	4	4	3	4	4	4	1	4	3

11 Appendix

- no data 1 resistant 2 practically resistant 3 partially resistant 4 not resistant	Medium	Formula	Concentration [%]	High Density Polyethylene	Polyamide	Polycarbonate	Polyoxymethylene	Polypropylene	Polysulfone	Polyvinyl chloride, hard	Polyvinyl chloride, soft	Polytetrafluorethylene	Acrylonitrile-butadiene- caoutchouc	Aluminium
				HDPE	PA	PC	POM	PP	PSU	PVC	PVC	PTFE	NBR	AL
	Chromic acid	CrO ₃	10	1	4	2	4	1	4	1	-	1	4	1
	Chromic potassium sulphate	KCr(SO ₄) ₂ x 12H ₂ O	saturated	1	2	1	3	1	-	1	-	1	-	3
	Citric acid	C ₆ H ₈ O ₇	10	1	1	1	2	1	1	1	1	1	1	1
	Citric acid	C ₆ H ₈ O ₇	50	1	3	1	2	1	-	-	-	1	1	1
	Copper sulphate	CuSO ₄ x 5H ₂ O	10	1	1	1	1	1	1	1	1	1	1	4
	Cyclohexanol	C ₆ H ₁₂ O	100	1	1	3	1	1	1	1	4	1	2	1
	Decane	C ₁₀ H ₂₂	100	-	1	2	1	3	-	-	-	1	2	1
	Diaminoethane	C ₂ H ₈ N ₂	100	1	1	3	1	1	-	3	4	1	1	1
	Diesel fuel	—	100	1	1	3	1	1	-	1	3	1	1	1
	Dimethyl formamide (DMF)	C ₃ D ₇ NO	100	1	1	4	1	1	4	3	-	1	3	1
	Dimethyl sulfoxide (DMSO)	C ₂ H ₆ SO	100	1	2	4	1	1	4	4	-	1	-	1
	Dimethylaniline	C ₈ H ₁₁ N	100	-	3	4	2	4	-	-	-	1	-	1
	Dioxane	C ₄ H ₈ O ₂	100	2	1	4	1	3	2	3	4	1	3	1
	Dipropylene glycol (mono)methyl ether	C ₄ H ₁₀ O	100	3	1	4	1	4	4	4	4	1	-	1
	Ethyl acetate	C ₄ H ₈ O ₂	100	1	1	4	1	1	4	4	4	1	4	1
	Ethylene chloride	C ₂ H ₄ Cl ₂	100	3	3	4	1	3	4	4	4	1	-	1
	Ferrous chloride	FeCl ₂	saturated	1	3	1	3	1	1	1	1	1	-	4
	Formaldehyde solution	CH ₂ O	30	1	3	1	1	1	-	-	-	1	2	1
	Formic acid	CH ₂ O ₂	100	1	4	3	4	1	3	3	1	1	2	1
	Furfural	C ₅ H ₄ O ₂	100	1	3	3	2	4	-	-	-	1	4	1
	Gasoline	C ₅ H ₁₂ - C ₁₂ H ₂₆	100	2	1	3	1	3	3	2	-	1	1	1
	Glycerol	C ₃ H ₈ O ₃	100	1	1	3	1	1	1	1	2	1	1	1
	Heptane, normal	C ₇ H ₁₆	100	2	1	1	1	2	1	2	4	1	1	1
	Hexane, n-	C ₆ H ₁₄	100	2	1	2	1	2	1	2	4	1	1	1
	Hydrogen chloride	HCl	5	1	4	1	4	1	1	1	-	1	2	4
	Hydrogen chloride	HCl	concentrated	1	4	4	4	1	1	2	3	1	4	4
	Hydrogen peroxide	H ₂ O ₂	3	1	3	1	1	1	1	1	-	1	3	3
	Hydrogen peroxide	H ₂ O ₂	30	1	4	1	4	1	1	1	-	1	3	3
	Hydrogen sulphide	H ₂ S	10	1	1	1	1	1	1	1	3	1	3	1
	Iodine, tincture of	I ₂		1	4	3	1	1	-	4	4	1	1	1

11 Appendix

- no data 1 resistant 2 practically resistant 3 partially resistant 4 not resistant	Medium	Formula	Concentration [%]	High Density Polyethylene	Polyamide	Polycarbonate	Polyoxymethylene	Polypropylene	Polysulfone	Polyvinyl chloride, hard	Polyvinyl chloride, soft	Polytetrafluorethylene	Acrylonitrile-butadiene- caoutchouc	Aluminium
				HDPE	PA	PC	POM	PP	PSU	PVC	PVC	PTFE	NBR	AL
	Isopropyl alcohol	C ₃ H ₈ O	100	1	1	1	1	1	1	1	4	1	-	2
	Lactic acid	C ₃ H ₆ O ₃	3	1	3	1	2	1	1	2	-	1	1	1
	Magnesium chloride	MgCl ₂	10	1	1	1	1	1	1	1	1	1	1	1
	Mercuric chloride	HgCl ₂	10	1	4	1	3	1	1	1	1	1	1	4
	Mercury	Hg	100	1	1	1	1	1	1	1	3	1	1	3
	Methyl acetate	C ₃ H ₆ O ₂	100	1	1	4	2	1	-	4	4	1	-	1
	Methyl alcohol	CH ₄ O	100	1	2	4	1	1	3	1	3	1	2	1
	Methyl benzene	C ₇ H ₈	100	3	1	4	1	3	4	4	4	1	4	1
	Methyl ethyl ketone (MEK)	C ₄ H ₈ O	100	1	1	4	1	1	4	4	4	1	4	1
	Methylene chloride	CH ₂ Cl ₂	100	4	3	4	3	3	4	4	4	1	-	1
	Mineral oil	—	100	1	1	1	1	1	1	1	-	1	1	1
	Nitric acid	HNO ₃	10	1	4	1	4	1	1	1	-	1	4	3
	Nitric acid	HNO ₃	100	4	4	4	4	4	-	4	-	1	4	1
	Nitrobenzene	C ₆ H ₅ NO ₂	100	3	4	4	3	2	4	4	4	1	4	1
	Oleic acid	C ₁₈ H ₃₄ O ₂	100	1	1	1	2	1	-	1	-	1	3	1
	Oxalic acid	C ₂ H ₂ O ₄ x 2H ₂ O	100	1	3	1	4	1	1	1	1	1	2	1
	Ozone	O ₃	100	3	4	1	4	3	1	1	-	1	4	2
	Petroleum	—	100	1	1	3	1	1	1	1	3	1	1	1
	Phenol	C ₆ H ₆ O	10	1	4	4	4	1	4	1	3	1	3	1
	Phenol	C ₆ H ₆ O	100	2	4	4	4	1	3	4	3	1	3	1
	Phosphoric acid	H ₃ PO ₄	20	1	4	2	4	1	-	-	-	1	2	4
	Phosphorus pentachloride	PCl ₅	100	-	4	4	4	1	-	4	4	1	-	1
	Potassium hydrogen carbonate	CHKO ₃	saturated	1	1	2	1	1	-	-	-	1	-	4
	Potassium hydroxide	KOH	30	1	1	4	3	1	1	1	1	1	-	4
	Potassium hydroxide	KOH	50	1	1	4	3	1	1	1	1	1	-	4
	Potassium nitrate	KNO ₃	10	1	1	1	1	1	-	-	-	1	1	1
	Potassium permanganate	KMnO ₄	100	1	4	1	1	1	-	1	-	1	3	1
	Pyridine	C ₅ H ₅ N	100	1	1	4	1	3	4	4	4	1	4	1
	Resorcinol	C ₆ H ₆ O ₂	5	1	4	2	3	1	4	2	-	1	-	2
	Silver nitrate	AgNO ₃	100	1	1	1	1	1	1	1	1	1	2	4

11 Appendix

- no data 1 resistant 2 practically resistant 3 partially resistant 4 not resistant		Concentration	High Density Polyethylene	Polyamide	Polycarbonate	Polyoxymethylene	Polypropylene	Polysulfone	Polyvinyl chloride, hard	Polyvinyl chloride, soft	Polytetrafluorethylene	Acrylonitrile-butadiene- caoutchouc	Aluminium	
			Medium	Formula	[%]	HDPE	PA	PC	POM	PP	PSU	PVC	PVC	PTFE
	Sodium bisulphite	NaHSO ₃	10	1	1	2	4	1	-	-	-	1	1	1
	Sodium carbonate	Na ₂ CO ₃	10	1	1	1	1	1	-	-	-	1	-	3
	Sodium chloride	NaCl	30	1	1	1	1	1	1	1	1	1	1	3
	Sodium hydroxide	NaOH	30	1	1	4	1	1	1	1	1	1	2	4
	Sodium hydroxide	NaOH	50	1	1	4	1	1	1	1	-	1	2	4
	Sodium sulfate	Na ₂ SO ₄	10	1	1	1	1	1	1	1	1	1	1	1
	Spirits	C ₂ H ₆ O	96	1	1	1	1	1	1	1	3	1	-	1
	Styrene	C ₈ H ₈	100	4	1	4	1	3	-	4	4	1	4	1
	Sulphuric acid	H ₂ SO ₄	6	1	4	1	4	1	1	1	-	1	2	3
	Sulphuric acid	H ₂ SO ₄	fuming	4	4	4	4	4	4	4	4	1	4	3
	Tallow	—	100	1	1	1	1	1	-	1	1	1	1	1
	Tetrahydrofuran (THF)	C ₄ H ₈ O	100	3	1	4	1	3	4	4	4	1	3	1
	Tetrahydronaphthalene	C ₁₀ H ₁₂	100	3	1	4	1	4	4	4	4	1	-	1
	Thionyl chloride	Cl ₂ SO	100	4	4	4	2	4	4	4	4	1	-	3
	Tin chloride	SnCl ₂	10	1	4	2	2	1	-	-	-	1	1	4
	Transformer oil	—	100	1	1	3	3	1	1	1	-	1	1	1
	Trichloroethane	C ₂ H ₃ Cl ₃	100	3	3	4	2	4	4	4	4	1	4	4
	Urea	CH ₄ N ₂ O	10	1	1	1	1	1	-	-	-	1	1	1
	Urine	—	100	1	1	1	1	1	-	1	1	1	-	2
	Vinegar	C ₂ H ₄ O ₂	10	1	4	1	1	1	1	1	1	1	2	1
	Vinegar	C ₂ H ₄ O ₂	90	1	4	4	4	1	3	1	4	1	-	1
	Wax	—	100	-	1	1		1	-	-	-	1	-	1
	Wines	—	100	1	1	1	2	1	1	1	1	1	-	4
	Xylene	C ₈ H ₁₀	100	3	1	4	1	4	4	4	4	1	4	1

11.6 EC declaration of conformity



EC – DECLARATION OF CONFORMITY

The product named hereinafter was developed, designed, and manufactured in compliance with the relevant, fundamental safety and health requirements of the listed EC directives and norms.

In the event of modifications that were not authorised by us or if the product is used in a manner that is not in line with the intended purpose, this declaration will be rendered void.

<i>Product name:</i>	Laboratory centrifuge
<i>Product type:</i>	Sigma 6-16S, 6-16HS
<i>Order number:</i>	10390, 10391, 10392, 10393
<i>Directives:</i>	2006/42/EC Machinery Directive 2014/35/EU Low Voltage Directive 2014/30/EU EMC Directive (EU) 2015/863 RoHS Directive
<i>Normes:</i>	EN 61010-2-020:2017 EN IEC 61000-3-2:2019 EN 61000-3-3:2013 EN 61326-1:2013

Sigma Laborzentrifugen GmbH

An der Unteren Söse 50
37520 Osterode
Germany

Authorised representative
for CE matters:
Eckhard Tödteberg

Osterode, 07/04/2020



General Manager

11 Appendix

11.7 Declaration of conformity – China RoHS 2



DECLARATION OF CONFORMITY

China RoHS 2 (Administrative Measures for the Restriction of the Use of Hazardous Substances in Electrical and Electronic Products)

Laboratory centrifuge models: Sigma 1-14, 1-14K, 1-7, 1-16, 1-16K, 2-7, 2-16P, 2-16KL, 2-16KHL, 3-16L, 3-16KL, 3-18KS, 3-18KHS, 3-30KS, 3-30KHS, 4-5L, 4-5KRL, 4-16S, 4-16KS, 4-16KHS, 4-16KRL, 6-16S, 6-16HS, 6-16KS, 6-16KHS, 6-16KRL, 8KS, 8KBS

Sigma Laborzentrifugen GmbH has made reasonable effort to avoid the use of hazardous substances in the products it manufactures (laboratory centrifuges).

A Product Conformity Assessment (PCA) was performed in order to determine whether the concentration of harmful substances in all homogeneous materials of the component parts is above or below the MCV limit (Maximum Concentration Value limit) as defined in GB/T 26572:

Mercury and its compounds: 0.1 % Cadmium (Cd) and its compounds: 0.01 %
 Lead (Pb) and its compounds: 0.1 % Hexavalent chromium (Cr (VI)) and its compounds: 0.1 %
 Polybrominated biphenyls (PBB): 0.1 % Polybrominated diphenyl ethers (PBDE): 0.1 %

表1 产品中有害物质的名称及含量
 Table 1: Name and content of hazardous substances in the product

部件名称 Component part (PCA)	有害物质 Hazardous substance					
	铅 Lead (Pb)	汞 Mercury (Hg)	镉 Cadmium (Cd)	六价铬 Hexavalent Chromium (Cr (VI))	多溴联苯 Poly-brominated biphenyls (PBB)	多溴二苯醚 Polybrominated diphenyl ethers (PBDE)
Electronic PCB, cables	X ¹⁾	○	○	○	○	○
Display	○	○	○	○	○	○
Housing	X ²⁾	○	○	○	○	○
Base, metal, accessories	X ²⁾	○	○	○	○	○

本表格依据SJ/T 11364的规定编制。
 This table is made according to SJ/T 11364.

11 Appendix



O: 表示该有害物质在该部件所有均质材料中的含量均在GB/T 26572规定的限量要求以下。
Indicates that the content of the harmful substance in all homogeneous materials of the component part is below the limit as defined in GB/T 26572.)

X: 表示该有害物质至少在该部件的某一均质材料中的含量超出GB/T 26572规定的限量要求。(企业可在此处, 根据实际情况对上表打“X”的技术原因进行进一步说明。)
Indicates that the content of the harmful substance in at least one homogeneous material of the component part exceeds the limit as defined in GB/T 26572. (Contact the manufacturer for further technical information according to the actual situation.)

1) Contains parts in compliance with exemptions 6c, 7c.I, 7c.II and 37 of 2011/65/EU RoHS.

2) Contains parts in compliance with exemptions 6a, 6b and 6c of 2011/65/EU RoHS.

Apart from the exemptions given in this table, none of the substances listed above have been intentionally added to the product or metallic coatings.

Sigma Laborzentrifugen GmbH

An der Unteren Söse 50
37520 Osterode
Germany

Osterode, 20/11/2017



General Manager

12 Index

A

Acceleration	42
Acceleration curve	42, 53, 78
Acceleration curve (changing)	53
Acceleration curve (creating)	53
Accessories, cleaning and care	65
Acid	20, 64, 65
Acoustic signal	60
Activating the help function	54
Adapters	34, 65
Alkaline solutions	20, 64, 65
Ambient conditions	74
Ambient temperature	74
Anodised coating	65
Application examples	13
ASTM standard	36
Autoclaving	69
Automatic lid opening function	50
Automatic program rotation	58
Automatic rotor identification	41

B

Blocking a function	48
Blood bag systems	35
Brake	42
Brakeless deceleration	42
Brakeless deceleration from set speed	48
Brief mains power failure	60
Bucket	34
Buckets, cleaning and care	66
Buzzer/signal	52

C

Capacity	74
Carrier	34
Carrier systems	34
Carriers, cleaning and care	66
CE mark in compliance with the directive 2006/42/EC	15
Centrifugation monitoring	47
Centrifugation of blood bag systems	35

Centrifugation of infectious, toxic, radioactive, or pathogenic substances	19
Centrifugation principle	13
Centrifugation with low capacity	33
Centrifugation with tubes in compliance with ASTM standard D91/D96	36
Centrifugation with vessels of various sizes	32
Centrifuge cannot be started	60
Centrifuge decelerates during operation	60
Centrifuge is inclined	60
Centrifuge was moved during run	60
Centrifuge, cleaning and care	64
Centrifuges - definition	9
Changes in colour	69
Changes in structure	69
Changing an acceleration curve	53
Changing the code	49
Chemical and biological safety	19
Chemical resistance of plastic	65
China RoHS 2 – Declaration of conformity	87
Cleaning agents	68
Cleaning the bores of angle rotors	65
Cleaning the centrifuge	64
Closing the lid	18, 29
Communication error	62
Condensation	27
Condenser dirty	60
Contamination	19, 65
Continuous heat resistance	68
Continuous run	40
Contrast (changing)	55
Control system	37
Copyright	10
Corrosion	18, 21, 34, 64, 65, 66, 68
Cost estimate	71
Cracking	65
Cracks	66
Creating an acceleration curve	53
Curve menu	53
Customer-provided fuses	27
Cycles	30, 52

Index

D

Damage of the surface.....	66
Dangerous goods.....	20
Dangerous materials.....	68
Date of manufacture	12
Deactivating the help function	54
Deceleration.....	42
Deceleration curve.....	42, 53, 78
Declaration of conformity	10, 85
Declaration of conformity – China RoHS 2.....	87
Declaration of decontamination.....	71, 73
Decontamination agent	65, 68
Deformation of tubes.....	69
Deleting a program	57
Density.....	12, 20, 46
Dialog box.....	23
Different service life of rotors and accessories	21, 80
Dimensions	25
Direct hazard to the life and health.....	16
Directive 2002/96/EC	73
Disinfectants	68
Disinfection of the rotor chamber and accessories	68
Display.....	37, 51
Display deceleration time	51
Disposal of the centrifuge.....	73
Disposal of the packaging	73
Documentation.....	10
Drive problem	60

E

Earth conductor check	23
EC declaration of conformity	10, 85
EEPROM error.....	62
Electrical connection	74
Electrical safety.....	18
Emergency lid release	61
Error correction	60
Error message	60
Executing a program.....	57
Explanation of the symbols and notes.....	16
Explosive substances	19
External signal	52

F

Fire preventions	19
Form for the return of defective parts	71
Function.....	50
Functional and operating elements	11
Fuses have tripped	60

G

General conditions	9
Glass breakage.....	68
Glass particles	68
Gravitational field	74
Grease for load-bearing bolts.....	64, 67

H

Hard running noise during the centrifugation	60
Hazard warnings.....	9, 30, 34
Heavy-duty grease for load-bearing bolts... ..	67
Help function.....	54
Hexagon socket wrench.....	10
Highly corrosive substances	18

I

Imbalance	32, 34
Imbalance error.....	62
Imbalance monitoring system	23
Importance of the operating manual.....	9
Important information	16
Improper loading.....	60
Infectious substances	68
Inflammable substances	19
Informal safety instructions	17
Initial start-up	29
Input fuse.....	74
Inspection by the manufacturer	70
Installation of a rotor	30
Installation of accessories	32
Installation of an angle rotor with a hermetic lid	30
Installation of rotors and accessories	30
Installation site	27
Insufficiently greased load-bearing bolts	67
Intended use.....	9
Interrupting a centrifugation run	38
Interrupting a deceleration process	38
Invert.....	51

IP code	74	No indication on the display	60
K		No power in the mains supply	60
Kinetic energy	12, 74	Noise level	74
L		Nominal voltage	12
Language.....	51	Notes on safety and hazards	9
Layout of the centrifuge.....	11	Notes on transport	25
Leaks	69	O	
Lid cannot be opened	60	Online download of forms	72
Lid error	62	Open lid after run	50
Lid lock device	23	Opening the lid.....	29
Lid lock has not released	60	Operating personnel	17
Lid seal sticks	60	Operating voltage.....	27
Limit "Delta T"	47	Operational safety.....	65
Linear curves	78	Option for the input and output of data	52
Loading a process.....	45	Options for data input and output.....	59
Loading a program.....	56	Overseas shipping	25
Lock.....	48	P	
M		Packaging.....	26
Mains power switch off.....	60	Parameter error	62
Mains switch	11	Parameters menu	46
Mains voltage.....	18	Pathogenic substances.....	19, 64, 68
Maintenance	64	Plastic accessories, cleaning and care.....	65
Malfunctions and error correction.....	60	Potential hazard to the life and health	16
Manual mode	38	Potentially hazardous situation.....	16
Manufacturer.....	74	Power consumption	12, 74
Marking of rotors.....	22	Power cord is not plugged in.....	60
Marking of the unit	15	Power supply	27
Maximum speed for tubes.....	34	Pressure marks.....	66
Measures in the event of hazards and accidents.....	24	Prevention of accidents.....	9
Mechanical safety	18	Problem description	71
Menu Curve	53	Process.....	46
Menu Help	54	Process error	62
Menu Parameters	46	Process library	45
Menu Processlibrary	45	Program "RAPID_TEMP"	43
Menu Setup	50	Program list.....	42, 56, 57
Menu Standard	39	Program mode	55
Mode of operation	13	Program rotation	50
Modification mode active.....	38	Programm "ASTM oil"	42
Motor error	62	Progress indicator	44
Motor shaft.....	30, 64	Protection class	27, 74
Multiple carrier	34	Q	
N		Quadratic curves.....	78
Name plate	11, 12	Quick stop.....	38

Index

R	
Radioactive substances	19, 64
Radius	14, 46
RAPID_TEMP program.....	43
RCF	39
Relative centrifugal force.....	39
Relative centrifugal force (RCF)	14
Removal of a rotor	30
Removal of the transport safety device	26
Remove glass particles and metal dust from the rotor chamber	68
Removing a rotor	31
Responsibility of the operator.....	17
Return of centrifuges, spare parts, or accessories	71
Return of defective parts	71
Risk of electrical shock.....	18
Rotor chamber	64
Rotor identification, automatic.....	41
Rotor monitoring system	23
Rotor radii	76
Rotor removal	31
Rotor selection list.....	41
Rotor tie-down screw	30, 66
Rotor wrench	10, 30
Rotors and accessories with a different service life	21, 80
Rotors for microtiter plate formats	30
Rotors, cleaning and care	66
Runtime	40
Runtime as of set speed	50
S	
Safety area	20
Safety devices	23
Safety distance	18, 20, 27
Safety instructions.....	9, 30, 34
Safety instructions for centrifugation	20
Safety of rotors and accessories	21
Safety, chemical and biological	19
Safety, electrical	18
Safety, mechanical.....	18
Safety-conscious work	17
Saving a program.....	56
Scope of supply	10
Screws of the transport safety device are not removed	60
Selection, display, and modification of data	38
Serial number	12, 63, 70
Service.....	70
Service contact	63
Service life	64
Service life of rotors and accessories... 21,	80
Service life of the accessories.....	69
Service work	70
Set-up and connection	27
Setup menu	50
Short run.....	40
Solvents.....	20, 64, 65
Sound signal	23
Sound signal (warning)	52
Spare part enquiries.....	63
Speed	12, 14, 39, 74
Speed/RCF fine	51
Speed-gravitational-field-diagram	77
Speedometer error.....	62
Spin-out from set speed	48
Standard menu	39
Standards and regulations	10
Standstill heating.....	46
Standstill monitoring system	23
Start delay.....	51
Starting a centrifugation run	38
Starting a process.....	45
Sterilisation of the rotor chamber and accessories	68
Stopping of the centrifuge due to an imbalance.....	67
Storage and transport	25
Storage conditions	25
Storage locations	74
Stress-corrosion see corrosion	66
Structural changes	19
Supply voltage	27
Supporting rings.....	34
Switching the centrifuge off	59
Switching the centrifuge on	29
System.....	52
System check	23

System error	60, 62	Type.....	12, 74
T		Type of connection.....	27
Table of error codes.....	62	Type of the centrifuge	63, 70
Table of rotors and accessories with a different service life	21, 80	U	
Technical data	74	Unblocking a function.....	49
Technical documentation	75	Ungreased load- bearing bolts	60
Temperature	39	Units of protection class I	27
Temperature error.....	62	Useful volume	
Temperature inside the rotor chamber	23	- volume that is stated for the tube	34
Temperature monitoring.....	47	User interface	37
Temperature monitoring system.....	23	UV radiation	27, 64
Temperature range	74	V	
Temperature unit.....	51	Vents	27
Temperature value not reached	60	Vessels	34
Thermal stress	64	W	
Time fine	51	Warning signal	52
Time range.....	74	Warranty and liability.....	9
Toxic substances	19, 64	Wear	70
Transport safety device.....	26	Weight	25
Tubes.....	34		