

PD1500A Series

Dynamic Power Device Analyzer/Double-Pulse Tester
for discrete IGBT, SiC, and GaN devices

- Characterize 650 V, 1.2 kV, and 1.7 kV-rated discrete devices
- I_D / I_C up to 200 A
- Fast slew rates, high bandwidth measurement probes



*Achieve repeatable,
reliable characterization
of wide-bandgap
semiconductors*

Introduction

Power converters are a key component enabling the electrification of the transportation, renewable energy and industrial markets. To facilitate needed advances in power converter design, new wide-bandgap (WBG) semiconductor technologies, based on silicon carbide (SiC) and gallium nitride (GaN), are being commercialized. WBG semiconductors provide major leaps in speed (10x to 100x faster than older designs), higher voltage and thermal operation, which in turn improve efficiency, reduce size and cost.

However, the resulting high-performance power converters are proving difficult to design due to many new challenges when characterizing WBG semiconductors. These difficulties delay the innovation of semiconductor manufacturers and engineers designing new converters.

Homegrown test systems have been the primary source for characterizing WBG semiconductors. Building these systems has been necessary because, to date, commercially available test systems have not been readily available. Unfortunately, it is difficult to produce repeatable and reliable measurement results with one-off, "homegrown" testers. Unreliable results create additional obstacles for power-converter designers when correlating their measurements with the semiconductor's data sheets.

To enable consistent, reliable characterization of WBG semiconductors, Keysight created the PD1500A dynamic power device analyzer platform. Initially employing the Double Pulse Test (DPT) technique, it has been developed in close collaboration with semiconductor manufacturers and designers from the energy and electric vehicle (EV) industries.

Reduce your time to market with the PD1500A

As an off-the-shelf measurement solution, the PD1500A delivers repeatable, reliable measurements of WBG semiconductors. The platform also ensures user safety and protection of the system's measurement hardware.

The ability to ensure repeatable DPT results is built on Keysight's expertise in measurement science. Examples include innovations in high-frequency testing (gigahertz range), low leakage (femto-ampere range), and pulsed power (1,500 A current, 10 μ s resolution). As a result, Keysight is uniquely positioned to help you overcome the challenges of dynamic power-semiconductor characterization.

Included with the PD1500A are standard measurement techniques such as probe compensation, gain/offset adjustment, de-skewing, and common mode noise rejection. These techniques are utilized within an innovative measurement topology and layout. A semi-automated calibration routine (AutoCal) that corrects for system gain and offset errors was specifically developed for this system. The system also uses advanced techniques to compensate for inconsistencies when measuring current.

Overview: Established and emerging measurement methods

Fully characterizing a SiC- or GaN-based WBG device requires both static and dynamic measurements. Keysight's B1505A and B1506A power device analyzers excel at static measurements. The PD1500A has the needed flexibility to address a variety of dynamic measurements and the evolution of JEDEC standards as they take shape.

Static measurements: The following parameters are typically used to understand the static characteristics of a power device:

- Output characteristics
- On-resistance
- Threshold voltage
- Transconductance
- Junction, input, output and reverse transfer capacitance
- Breakdown voltage
- Gate charge

Static measurements: Power device analyzers

Keysight is the industry's *de facto* leader in static measurements, and the preferred solutions are the B1505A and B1506A power device analyzers.

The B1505A provides the broad and deep measurement capabilities needed by developers creating new semiconductor devices. The B1506A provides the core set of test functions more commonly needed by product designers when evaluating semiconductor devices for use in a power module.

www.keysight.com/find/B1505A

www.keysight.com/find/B1506A

Dynamic measurements: As JEDEC continues to define the dynamic testing of WBG devices, some standardized tests are starting to emerge. The DPT determines these key performance parameters:

- Turn-on characteristics
- Dynamic on-resistance
- Switching characteristics
- Gate charge
- Turn-off characteristics
- Dynamic current and voltage
- Reverse recovery
- Derived output characteristics

Ruggedness testing (coming soon): Since WBG devices operate with high voltages and at high temperatures, characterizing ruggedness is necessary. The key measurements determined by short-circuit testing and avalanche testing include:

- Short-circuit conduction time
- Short-circuit energy
- Avalanche energy

Dynamic power converter design challenges

Semiconductor and power engineering teams are in a tenuous position. The market forces them to quickly develop and ship reliable products, while needing to overcome changing technology, unreliable measurements in a hazardous test environment. In the absence of commercial characterization solutions, most engineering teams have been forced to develop their own solutions. Some of their key challenges are listed below:

- Improving efficiency has resulted in higher frequency switching converters. Accounting for the high-frequency energy is important in both characterizing power semiconductors and in modeling and simulating them in power converter designs. This additional complication challenges the traditional power designer.
- The combination of increased frequency and higher power affects the reliability of the measurements. It is often hard to distinguish whether the measured signal is the device characteristic or the parasitic characteristic of the measurement setup.
- Operating with greater voltage (> 1000 V) and current (> 100 A) levels leads to a more hazardous test environment. Design and test engineers need to use extra precaution when working with lethal power levels.
- The process for making WBG semiconductors is still maturing and is not as well studied as Si-based semiconductors. The resulting unproven reliability makes it difficult for many designers to commit to WBG devices for their designs. This isn't stopping some designers from using these new devices for mission critical applications such as renewable energy and EV's.
- Characterization and test standards are under development and will soon drive a common methodology for testing WBG devices.



JC-70 Wide-Bandgap Power Electronic Conversion Semiconductors

The JEDEC standards recognized the need to provide WBG standards for the power semiconductor industry.

In September of 2017, the JC-70 Wide Bandgap Power Electronic Conversion Semiconductor committee was formed for both GaN JC-70.1 and SiC JC-70.2

Each section has three task groups, focusing on Reliability and Qualification Procedures, Datasheet Elements and Parameters, and Test and Characterization Methods. Keysight actively participates in developing these standards.

As a result of the challenges above, WBG device manufacturers struggle to consistently characterize their devices. Data sheets often provide specifications defined more narrowly than the breadth of a specific application (e.g., temperature). These specifications are often typical and not guaranteed. As a result, power-converter designers often end up characterizing the semiconductors themselves, augmenting the manufacturer's provided specifications. Obviously, new approaches are needed for characterizing, modeling and simulating power semiconductors and their respective converter designs.

DPT Parameters

Group	Parameters	Description	Associated Standards
Turn-On Characteristics	$t_{d(on)}$, t_r , t_{on} , $e_{(on)}$, dv/dt , di/dt	Characterizes how quickly the transistor can turn on, the maximum di/dt and dv/dt , and the resulting energy loss. Contributes to switching loss characteristic.	FET – IEC 60747-8 IGBT – 60747-9
Turn-Off Characteristics	$t_{d(off)}$, t_f , t_{off} , $e_{(off)}$, dv/dt , di/dt	Characterizes how quickly the transistor can turn off, the maximum di/dt and dv/dt , and the resulting energy loss. Contributes to switching loss characteristic.	FET – IEC 60747-8 IGBT – 60747-9
Switching Characteristics	I_d vs. t , V_{ds} vs. t , V_{gs} vs. t , I_g vs. t , Clamped V_{ds} vs. t , e vs. t , I_d vs V_{ds} (switching locus)	These time-based parameters are waveforms retrieved directly from the oscilloscope. The I_d vs V_{ds} (switching locus) are derived from the waveforms.	
Reverse Recovery	t_{rr} , Q_{rr} , E_{rr} , I_{rr} , I_d vs. t	Characterization of reverse recovery of body diode in vertical FETs. Provides additional timing information regarding how quickly the transistor can switch between on and off.	IEC 60747-8 JESD 24-10
Gate Charge	V_g vs. Q_g , ($Q_{gs(th)}$, $Q_{gs(pl)}$, Q_{gd})	The voltage and the current of the gate are measured during a double pulse turn-on operation. The charge on the gate during different gate voltage transitions is characterized. This parameter is used to determine the driving loss of the transistor.	JESD 24-10
Derived Output Characteristics	I_d vs. V_g , I_d vs. V_d	Provides basic transfer characteristics for the semiconductor.	

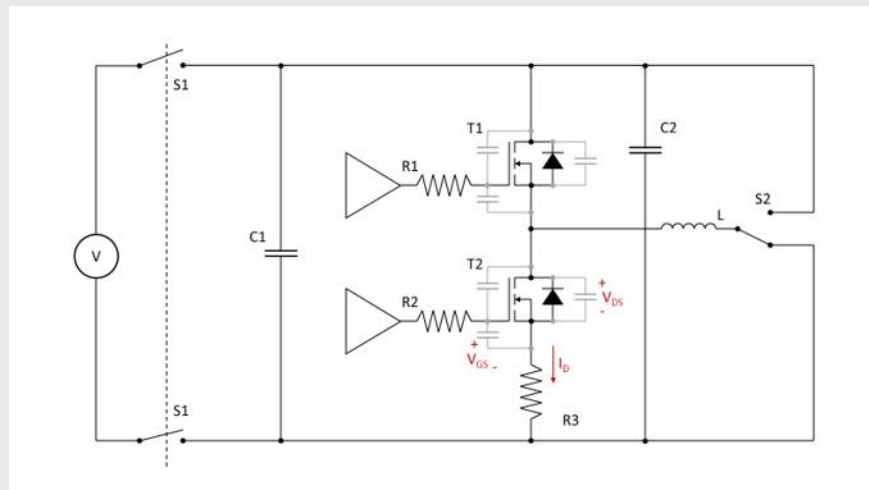

Figure 3. Basic reverse recovery test configuration (T2 body diode – DUT)

Reverse recovery is also measured using a double pulse, but the load inductor is now switched across T2 and T1 is used to charge the inductor. After T1 is turned off, the body diode in T2 conducts. When T1 is turned on again, the reverse recovery of T2 can be measured.

Repeatable, Reliable Measurements

Common Measurement Practice

Keysight's PD1500A uses many common measurement practices. Some attenuation probe errors are eliminated by compensating the passive probes and adjusting the offset of the differential probe as recommended. Care was taken to minimize parasitic capacitance and inductance when laying out the DPT setup in the fixture. In order to correlate the timing of each measurement probe, de-skew is also implemented.

AutoCal

Gain and offset errors for each oscilloscope channel/probe can often lead to errors in the DPT waveforms, which will impact the extracted parameters. The PD1500A incorporates an automatic calibration technique that uses a known-good accurate, internal system voltage standard to measure and characterize each oscilloscope channel. Gain and offset errors are compensated for to provide more accurate and repeatable DPT waveforms.

Current Shunt Compensation

Current shunts can have poor bandwidth and inconsistent performance from shunt to shunt. Keysight characterized a popular coaxial shunt with a network analyzer and found a wide variability in bandwidth, from ~25 MHz to 300 MHz. This variability significantly impacts dynamic testing of higher-speed WBG power devices. Every PD1500A system is supplied with a pre-compensated current shunt that is used for I_D / I_C measurements. The compensation applies the inverse of the shunt's transfer function to the output signal measured in order to flatten the response across the bandwidth of interest. This method increases the accuracy of I_D / I_C measurements, resulting in a more accurate extraction of DPT parameters.

Safe Test Environment

Your safety is critical when testing power semiconductors. Keysight designed multiple safety features into the PD1500A to enhance your safety. The test environment is covered by a transparent hood, protecting the user from contacting high voltages. When $> 42V$ is energized, the hood is locked and the red light is illuminated.

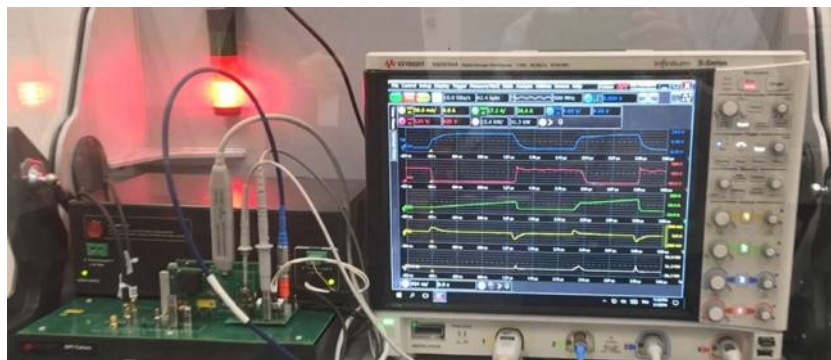

For further protection, the PD1500A provides an Emergency Off Operation (EMO) button to disconnect high voltages when pressed.

Expandable Power Device Platform

The initial PD1500A introduction focuses on performance testing such as DPT for IGBT and SiC discrete devices. However, the PD1500A platform was developed with modularity in mind, enabling expansion of its capabilities as needs and standards develop.

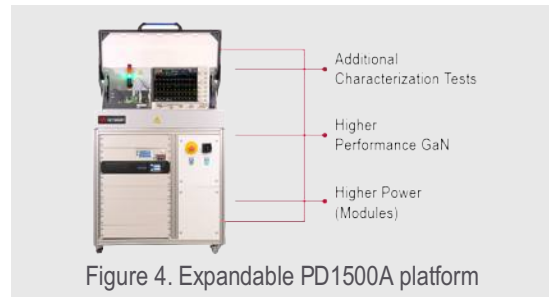

Figure 4. Expandable PD1500A platform

Planned Future Enhancements

Higher Performance GaN Characterization: The higher switching speeds of GaN make it particularly challenging to test. Therefore, new enhancements focussed on fixturing and an increased performance will be developed for GaN discrete devices.

Higher Power Module Testing: Many developers purchase modules (2x, 4x, 6x, etc.) for their power converter designs instead of discrete devices. Higher power module testing capability for power converter applications such as the EV market will be added.

Additional Characterization Tests: Ruggedness tests (short circuit and avalanche) are planned to be added to the platform in the future. As the JEDEC JC-70 standard evolves, we will continue enhance the suite of characterization tests.

PD1000A Power Device Measurement System for Advanced Modeling

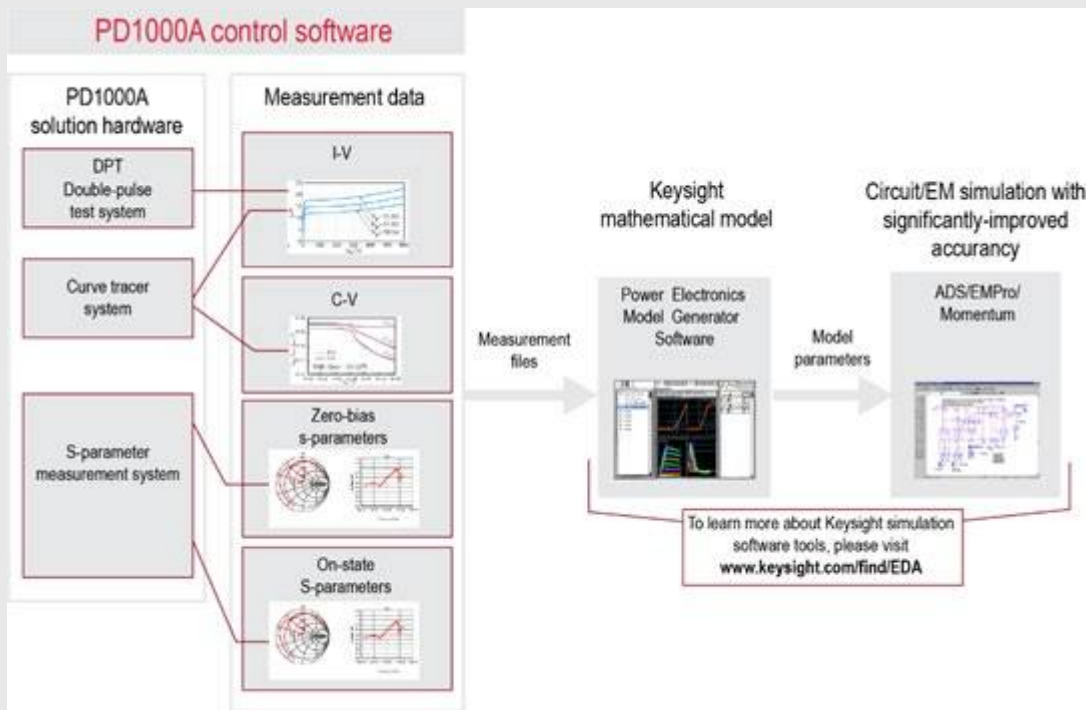

Key Features

- Easily create models you can trust for any WBG device with real measurements right on your bench*
- Exclusive WBG device modeling results in accurate simulations of EMI, in-rush, overshoots, switching time, etc.
- Easily identify causes of EM noise in simulation, before the design is finalized
- Complete, one-vendor solution of hardware, software, consulting and support services worldwide

Please reference the PD1000A Power Device Measurement System for Advanced Modeling Solution Brochure ([5992-2700EN](#)) for more information.

PD1500A Overview and Basic Operation

The PD1500A is designed to be modular, allowing for a variety of devices (SiC, IGBTs, Si MOSFETs and GaN), characterization tests (DPT, reverse recovery, gate charge), ruggedness tests (short-circuit, avalanche), different power levels ($> 1.2 \text{ kV}$, $> 200 \text{ A}$), and module test. The initial system provides complete DPT characterization and parameter extraction for discrete power semiconductors, supporting maximum power operation at 1.2 kV and 200 A .

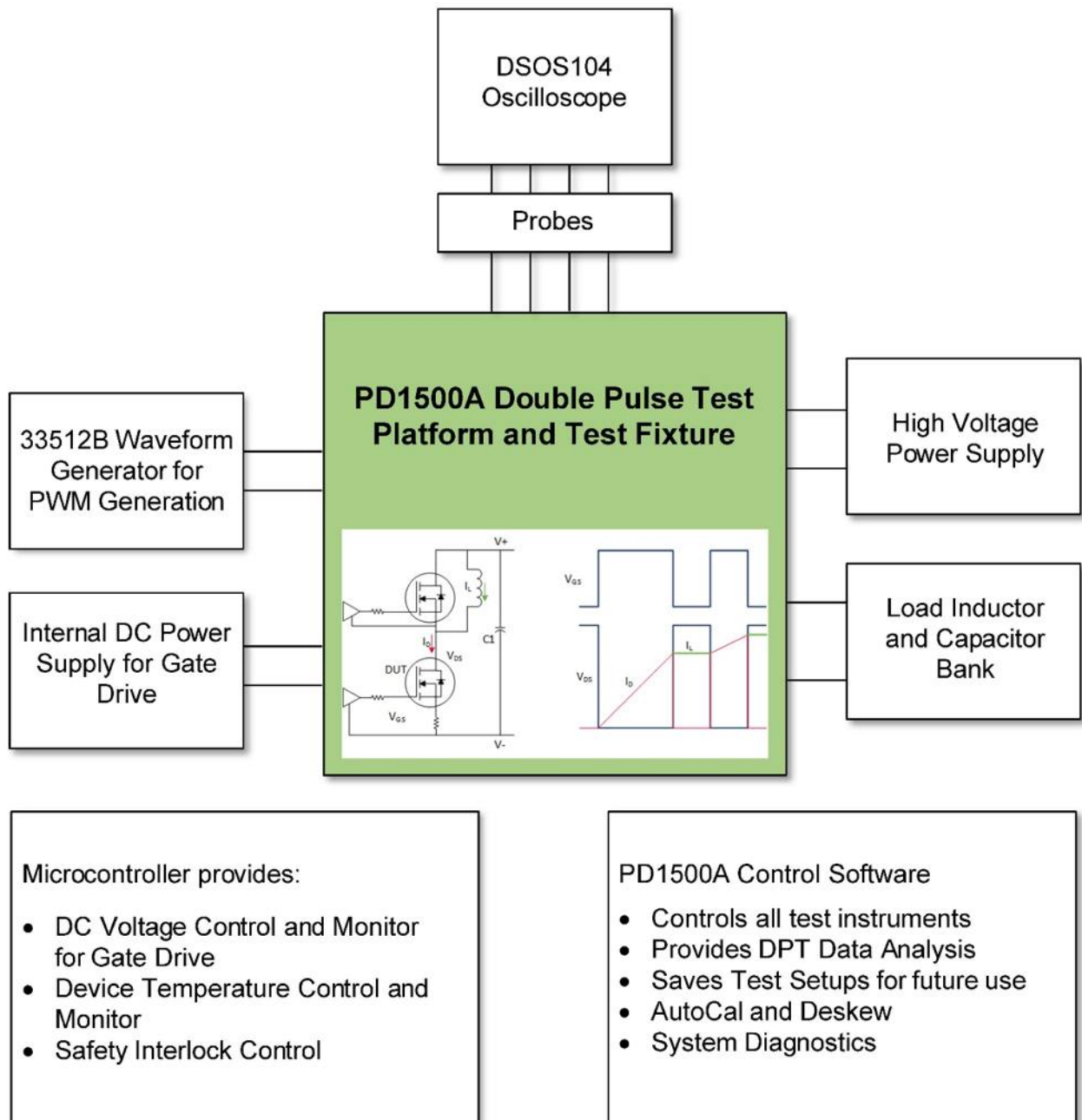

Figure 6. PD1500A block diagram

The PD1500A fixture allows TO-247 (3- or 4-pin) or SMD packages to interface with the system. Connections for de-skew and AutoCal are readily available. When high-current and module testing is included, the system will scale to the appropriate size for the DC-link capacitor and load inductors. When high performance GaN testing is included, the gate drivers, clamp circuit, DC-link capacitors and load inductors will be integrated into a single PCA.



Figure 7. PD1500A fixture

Temperature Test

The PD1500A enables testing of characteristics over a temperature range (ambient temperature up to 150°C for SMD; up to 175°C for TO-247). A small heater is connected directly to the DUT for maximum heat conduction. The temperature is monitored (K-type thermocouple) and controlled by an internal microcontroller.

User Configuration, Control and Analysis

The PD1500A is controlled with a simple and flexible graphical user interface. It provides test setup, execution, DPT display and data logging. Both the raw waveform and the extracted parameters are available from the local database. A simple semi-automated sequence is shown below.

1. Insert DUTs on the test module
2. Attach heater and thermocouple (if used)
3. Assemble test modules (DUT, clamp, gate driver modules) onto test fixture
4. Connect probes to test modules
5. Set up test parameters in the control software
6. Press "Start"
7. Repeat steps 4 and 5 for reverse recovery diode test or other tests

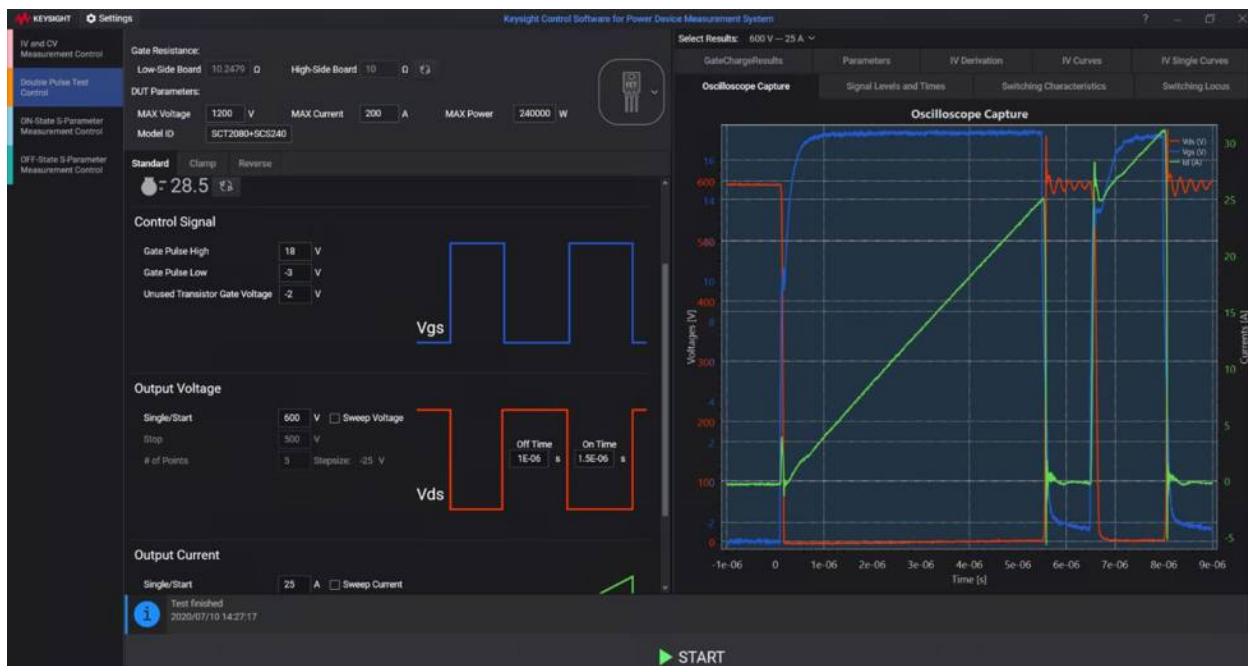

Figure 8. Example PD1500A user interface

Tested Parameters^{1,2}

Test	Parameter / Characteristics	Symbol	
Double Pulse Test/Clamp	Turn-on delay time	td(on)	
	Turn-off delay time	td(off)	
	Rise time	tr	
	Fall time	tf	
	Turn-on time	ton	
	Turn-off time	toff	
	Turn-on energy	e(on)	
	Turn-off energy	e(off)	
	di/dt	di/dt	
	dv/dt	dv/dt	
	On-resistance	Rds(on)	
	Switching characteristics	Id vs. t	
		Vds vs. t	
		Vgs vs. t	
Ig vs. t			
Clamped Vds vs. t			
Switching locus	Id vs Vds ³		
Reverse Recovery	Reverse recovery time	trr	
	Reverse recovery charge	Qrr	
	Reverse recovery energy	Err	
	Maximum reverse recovery current	Irr	
	Reverse recovery current characteristics	Id vs. t	
Gate Charge ⁴	Total gate charge	Qg	
	Plateau gate charge	Qgs(pl)	
	Gate drain charge	Qgd	
	Gate charge curve	Vgs vs. t	
Multiple Tests	Derived output characteristics	Id vs. Vd ³	

¹ Based on IEC 60747 and JESD24 standards

² Long off time leads to significant loss of inductor current. This leads to limitations of parameter extraction

³ Quality of the characteristics depends on the cleanliness of measured switching characteristics.

⁴ Gate charge parameter extraction requires gate current monitoring. The quality of gate charge parameters depends on the smoothness of the measured curve. High gate resistance (e.g. ≥ 100 Ohm) is recommended.

Specifications

Category	Type		Item	Specification			
Electrical	General		Sample Rate	10 GSa/s			
			Sampling Accuracy	12 ppb + 75 ppb/year			
			Deskew Accuracy	200 ps (typical)			
	Drain/ Collector Channel	DC	Source	Max Voltage	1200 V ⁵		
				Min Voltage	50 V		
				Max Current	200 A ⁶		
				Min Current	10 A		
				Voltage Programming Resolution	23 mV		
		Measure	Voltage Accuracy	2% of range (typical)			
			Current Accuracy	4% of range (typical)			
			AC	Measure	Voltage probe bandwidth	500 MHz	
					Current shunt bandwidth (compensated)	400 MHz (typical)	
					Voltage transition time	< 10 ns (depends on DUT response, Rg)	
					Gate	DC	Source
	Low Level Max/Min Voltage	0 V / -10 V					
	Voltage Resolution	<0.1 V (typical)					
	Max Current	10 A (sink and source)					
	Measure	Voltage Accuracy	2% of range (typical)				
		Current Accuracy	4% of range (typical)				
		AC	Source	Timing Resolution / Accuracy		100 ps / 200 ps	
Typical 1st Pulse Width	1 to 60 μ s						
Min Pulse Width (1st Pulse)	1 μ s						
Max Off-Time between 1st and 2nd Pulse	25 μ s ⁷						
Min Off-Time between 1st and 2nd Pulse	200 ns ⁸						
Max Pulse Width (2nd Pulse)	10 μ s ⁹						
Min Pulse Width (2nd Pulse)	200 ns ⁸						
Measure	Voltage probe bandwidth	500 MHz					
	Current probe bandwidth	800 MHz					

⁵ Maximum supply voltage 1.2 kV; capable of characterizing 650 V, 1.2 kV, and 1.7 kV-rated devices; Clamp circuit limits max voltage to 400 V.

⁶ 200 A is maximum system current; limited test voltage see Figure 9 on Page 14.

⁷ Big values for off-time lead to significant loss of inductor current. This leads to limitations of parameter extraction

⁸ Smaller values may be possible but are not recommended and tested

⁹ Second pulse-width must be selected so that max system current is not exceeded

Specifications (continued)

Category	Type	Item	Specification	
Electrical	Modular Components	Load Inductors (typical)	120 μ H	
			16.7 μ H	
		DC-Link Capacitor (typical)	800 μ F @ \leq 200 V	
			144 μ F @ $>$ 200 V to \leq 400 V	
			36 μ F @ $>$ 400 V to \leq 880 V	
		12 μ F @ $>$ 880 V		
DUT	Discrete devices	MOSFET, IGBT		
		Silicon and SiC		
		TO-247-3, TO-247-4, D2PAK7		
Temperature Control		Heater (Option H01)	Ambient temperature to 175°C ¹⁰	
System	Mechanical	Safety Enclosure	Size – safety hood closed	92 cm (W) x 72 cm (D) x 151 cm (H)
			Size – safety hood open	92 cm (W) x 87 cm (D) x 168 cm (H)
			Weight – enclosure only	120.5 kg
			Weight – complete system	162.0 kg
		SIC Fixture	Size	32cm (W) x 25cm (D) x 16cm (H)
			Weight	5.3 kg
		Environmental	Operating Temperature	20 °C to 30 °C
			Operating Humidity	50 % to 70 % RH, non-condensing
			Operating Altitude	Up to 3000 m
			Warmup time	1 hour
			Storage Temperature	0 to 40 °C
		Line Power	Voltage	200 V to 240 V, \pm 10% 50/60 Hz
			Power Consumption	600 VA
		Protection & Safety	Emergency Off switch (EMO)	
			Oscilloscope protection (Clamp output)	\pm 15 V (typical)
	Safety Hood		Maximum energy in the system	16 J (typical)
			Lock	$>$ 42 V ¹¹ (typical)
			Open hood detection	High-voltage disconnect; DC-Link capacitor discharged
	Over-temperature Shutdown	$>$ 50 °C (typical)		
Interface	LAN		10/100/1000 Base-T Ethernet	

¹⁰ TO-247 only; D2PAK7 limited to 150°C

¹¹ Safety hood cannot be opened when $>$ 42 V is present in the system

Specifications (continued)

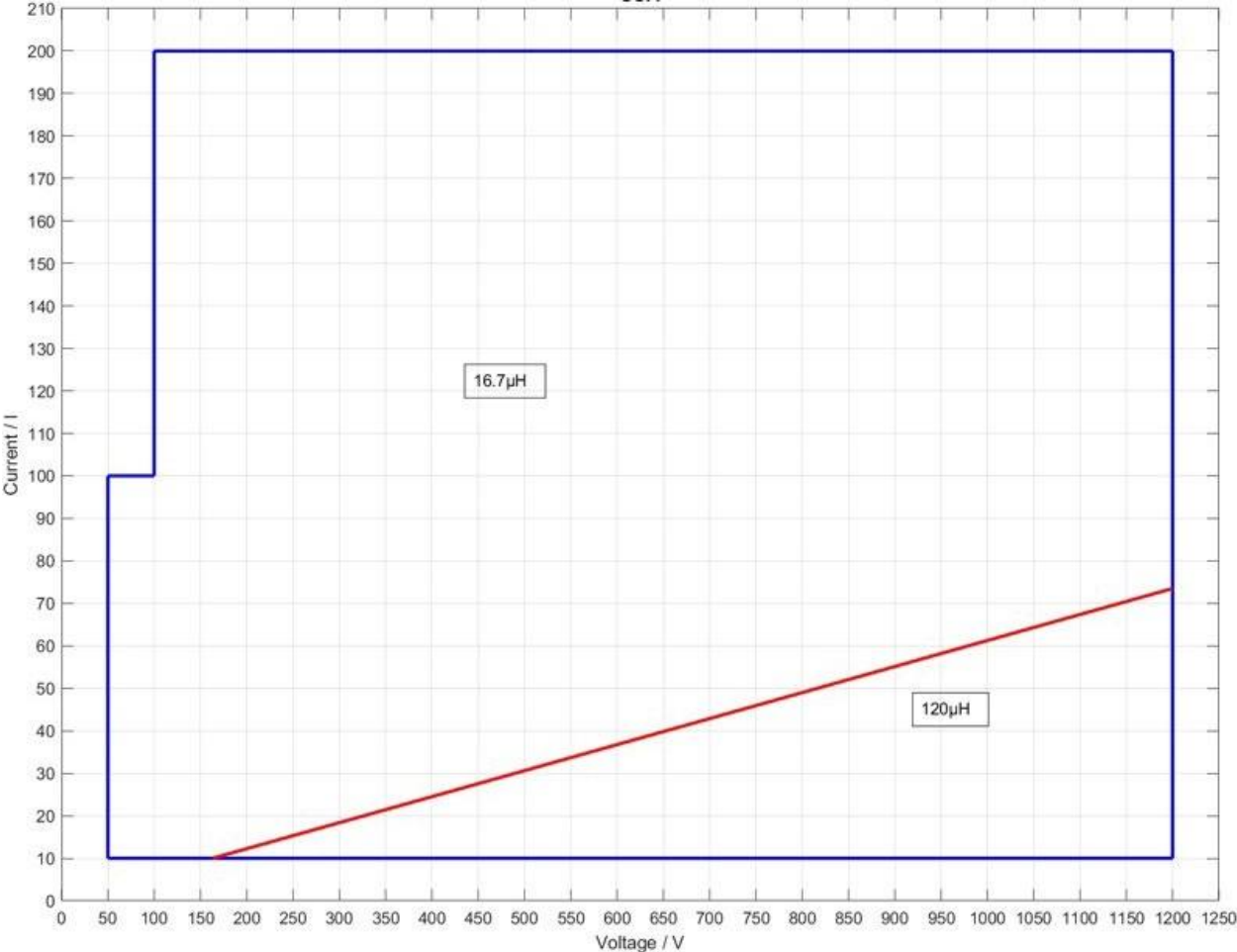

Figure 9. PD1500 inductor use for Current vs. Voltage

How to Order

How to order your PD1500A Dynamic Power Device Analyzer/Double Pulse Tester

PD1500A Core System (1 required)

The core PD1500A system is comprised of all the necessary equipment to perform dynamic / double-pulse testing. A list is provided below for reference:

PD1500A Core System
1 x DSOS104A, DPT Oscilloscope with accessories
1 x Oscilloscope protection probe
1 x 1.2kV high-voltage power supply with accessories
1 x 33512B, DPT Function generator with accessories
1 x Auto calibration basic pack
1 x DPT Rack & Safety Enclosure with accessories

Fixture Options (1 required)

Option	Description
SIC	DPT Fixture for discrete device modular system

DUT Boards (1 required)

Choose the DUT boards that match the device(s) under test. Required to mount the DUT to the fixture.

Option	Description
247	DUT Board for discrete TO-247-3 devices
24K	DUT Board for discrete TO-247-4 devices
D2P	DUT Board for discrete D2PAK7 devices

Coaxial Shunt (1 required)

Choose a coaxial shunt. Required for I_D measurements.

Option	Description
SH1	10 mOhm BNC shunt

How to Order (continued)

Gate Driver Boards (1 pair required)

Choose gate driver board pairs (high and low). Required to drive the gates of the high and low devices.

Option	Description
GD1	Low-side gate drive board, blank Rg
GD2	High-side gate driver board, blank Rg
GD3	Low-side gate drive board, 0 Ohm Rg
GD4	High-side gate driver board, 0 Ohm Rg
GD5	Low-side gate drive board, 10 Ohm Rg
GD6	High-side gate driver board, 10 Ohm Rg
GD7	Low-side gate drive board, 100 Ohm Rg
GD8	High-side gate driver board, 100 Ohm Rg

Clamp Circuit Board for Rds(on) measurement (1 required)

Choose at least one clamp circuit board. Required to perform Rds(on) measurements.

Option	Description
CB1	Clamp circuit board

DUT Heater Kit (1 required)

Choose at least one heater kit.

Option	Description
H01	DUT Heater Kit for TO-247 and D2PAK

For more information, please go to www.keysight.com/find/PD1500A.

Learn more at: www.keysight.com

For more information on Keysight Technologies' products, applications or services, please contact your local Keysight office. The complete list is available at: www.keysight.com/find/contactus

