

81195A Optical Modulation Generator Software

Version 1.1

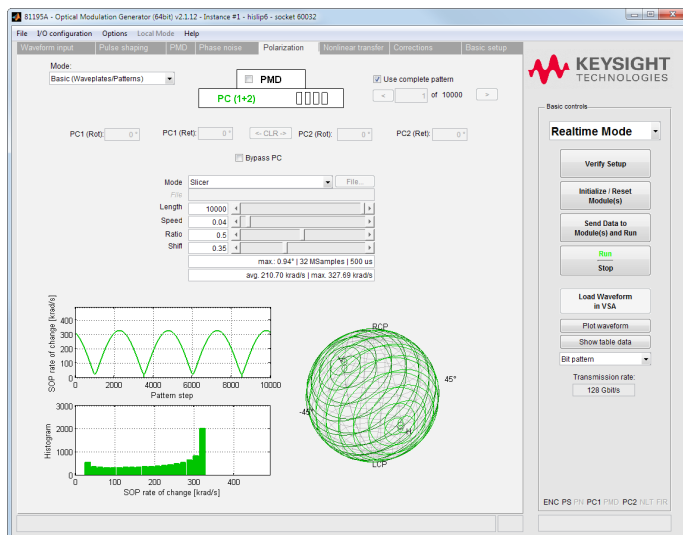

Product Description

The latest developments in 200G, 400G and 1Tb coherent optical transmission systems are challenging test engineers. More and more flexibility is required to generate clean modulated signals as well as signal impairments to stress coherent receivers over multiple test scenarios.

The 81195A optical modulation generator software introduces an innovative soft-ware-defined test approach. It enables generation of dual-polarization complex modulated signals as well as electronic synthesis of optical signal impairments such as phase noise, polarization rotation, and polarization mode dispersion (PMD), both in real time with M8195A or in a traditional waveform generation mode using M8195A, M8196A or M8194A Arbitrary waveform generators.

Combined with the M8195A 65 GSa/s arbitrary waveform generator hardware Digital Signal Processor functions it improves up to 100x the speed of test, the cost and the predictability of the output

In traditional fiber transmission and optical receiver testing, which uses optical elements for stress conditioning, the stress conditions can only be changed in a stochastic way resulting in long test times.

In contrast, this new test approach allows you to generate and reproduce dynamic stress conditions with precise time evolution or stress statistics, increasing test coverage and reducing test time. The 81195A software in conjunction with a four-channel Keysight Technologies arbitrary waveform generator can generate clean and distorted signals.

With the digital signal processing (DSP) block of the M8195A, the parameters of the waveform (e.g. the pulse-shaping filter coefficients) and the impairments can be adjusted at run time without downloading a new waveform. The real-time waveform generation enables deterministic emulation of optical signal properties over a long period of time, which previously has not been possible.

Key Features

- Waveform calculation for dual-polarization, complex modulated signals (up to 256QAM)
- Supporting hardware DSP in M8195A for real-time waveform generation
- Off-line waveform generation for M8196A, M8194A and multi-module M8195A AWGs setups
- Effective use of the available M8195A module memory in real-time waveform generation mode for complex modulated signals (up to 8 GSym per channel on two IQ channels simultaneously at up to 32.5 GBaud)
- Realistic emulation of optical signal properties and impairments, including phase noise, polarization mode dispersion, and polarization rotation over a long period of time
- Change signal properties, 'on-the-fly' without needing to re-calculate the entire waveform (saves valuable time during debug and characterization)
- Output triggers synchronized with impairment generation
- Corresponding analysis capabilities in the Keysight Technologies optical modulation analyzer portfolio

Waveform Creation Methods

The 81195A software provides two means of generating waveforms. As shown in the figure below, waveform mode creates them using software algorithms. Real-time mode uses the M8195A hardware DSP block to create the waveforms.

Waveform mode

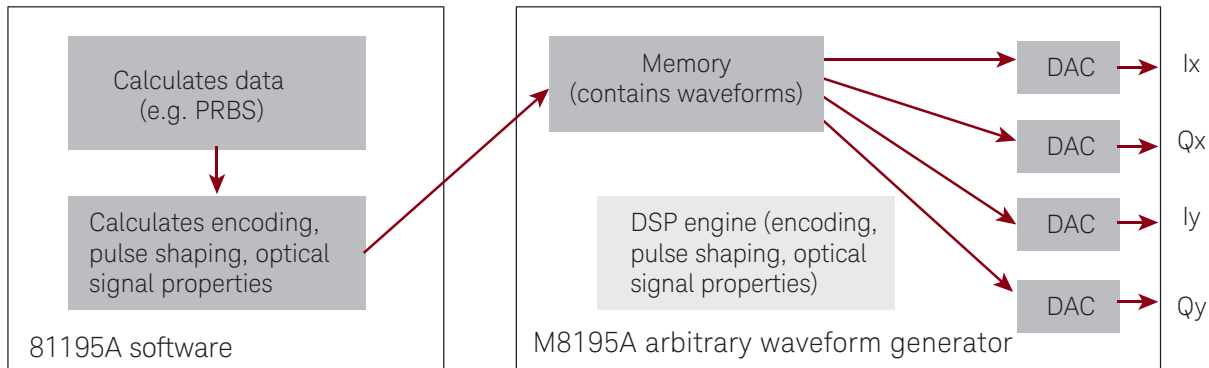

Real-time mode

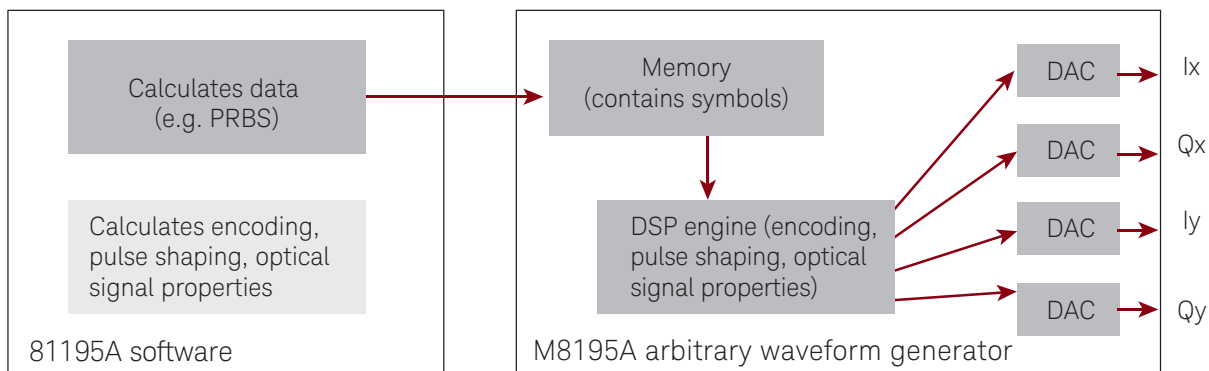

Each method has distinct benefits:

- In waveform mode
 - A wide range of baud rates are available (real-time mode is limited to certain ranges)
 - Signal waveforms with non-integer number of samples per symbol can be generated using waveform resampling
- In real-time mode
 - Signal properties like pulse shaping parameters and signal impairments can be modified at run-time without need for re-calculating and re-downloading a new waveform, significantly reducing test time
 - Real-time operation allows signal property generation and variation, such as polarization rotation, either as fast transients or slowly changing effects over a long period of time
 - Trigger output, which is aligned with the signal impairment pattern, can be used to synchronize test equipment, e.g. time-to-error measurement with BERT

Real Time DSP Engine

The real time DSP engine on the AWG chip of the M8195A arbitrary waveform generator consists of a fixed concatenation of pre-defined DSP functions and FIR filters, with programmable coefficients. Coefficient memories of various sizes are available to change the DSP characteristic upon external triggering or according to a repetitive dynamic impairment pattern. Output triggers are generated in sync with the coefficient patterns.

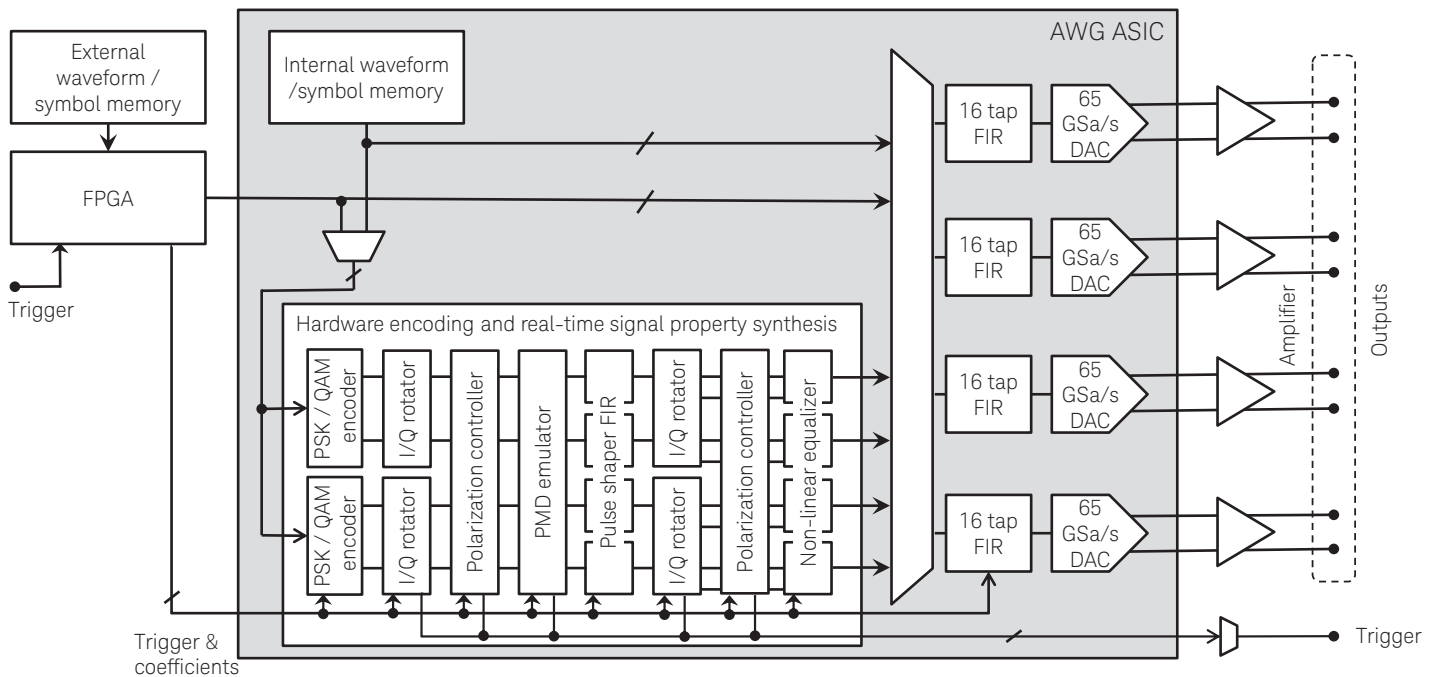

PSK/QAM encoder

For the real-time DSP operation, the AWG memory stores the data pattern symbols which are then encoded using the PSK/QAM encoder based on reconfigurable look-up tables (LUT), instead of storing the pre-calculated waveform samples of the desired signal.

IQ rotator

The IQ rotator consists of two identical blocks where an instantaneous rotation angle, controlled from a pre-programmed coefficient pattern memory, is applied to the complex IQ signal for both the X and Y polarization, emulating, for example, carrier phase noise or a frequency offset.

Polarization controller

The polarization controller is a one-tap butterfly filter and alters the state of polarization (SOP) by acting like a concatenation of a circular and linear retarder. Rotation angle and retardation can be controlled from a pre-programmed pattern memory, which allows complex SOP trajectories on the Poincare sphere to be synthesized.

PMD emulator

Based on the model of multi-segment concatenation of birefringent elements, the PMD emulator block is a complex FIR butterfly structure in which its filter coefficients represent the optical channel's PMD impulse response.

Pulse shaper FIR

For a spectrally efficient transmission channels, the data symbols can be filtered with a general 16-tap FIR filter to flexibly vary the pulse shaping such as raised or root-raised cosine or the roll-off factor.

Non-linear equalizer

The non-linear equalizer applies a non-linear transfer function based on a broken line approximation algorithm to the data signal, allowing, for example, the equalizer to compensate for the transfer characteristic of an electro-optical modulator.

Product Structure

The product structure of the 81195A optical modulation generator software is divided into

- Base functionality/waveform mode (does not require any option)
- Real-time signal processing/real-time mode (requires option #RSP)
- Optical signal properties (requires option #OSP)

In the product description below, features that require one of the options are marked with #RSP or #OSP respectively.

The 81195A GUI contains a number of tabs to setup the data pattern, modulation scheme, pulse shaping, and optical signal properties.

Supported AWG Setups

- Support for single module setup (1x M8195A #004 or #002) – waveform mode and real-time mode (#RSP)
- Support for 4 module setup (4x M8195A #001 with sync module M8197A) – in waveform mode only¹
- Support for single module M8196A #004 or #002 – in waveform mode only¹
- Support for single module M8194A #004 or #002 – in waveform mode only¹

Specifications

Waveform generation

Data source

- Load external waveform and data patterns (supported formats: CSV, MAT89600 *.mat, *.ptrn)
- Generate waveforms of the following formats:
 - Standard waveforms (sine, rectangle)
 - Complex modulated (BPSK, QPSK, 8-PSK, 8-QAM (circ.), 16-QAM, 32-QAM, 64-QAM, 128-QAM, 256-QAM) with user-definable constellation rotation angle (phase offset)
 - User-defined constellation

1. RSP functionality is not support for this setup

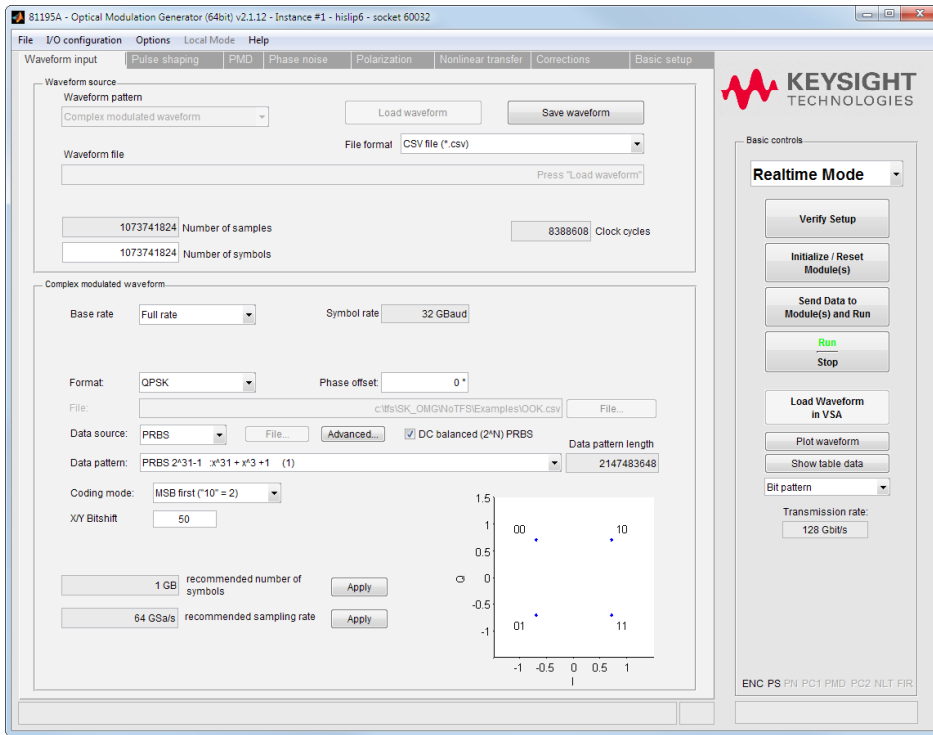

Symbol rates

- In Real-time mode: 27...32.5 GBaud/13.5 ... 16.25 GBaud/7.25 ... 8.125 GBaud (i.e. $fs/2$, $fs/4$, $fs/8$ with fs being the sampling rate)
- In Waveform mode: Arbitrary resampling rates, e.g. 45 GBaud with appropriate pulse shaping

Display

- Constellation plot
- Transmission rate

Data generation

- PRBS (PRBS7, ..., PRBS23, PRBS31) selectable per channel
 - Selectable MSB first/LSB first coding
 - Selectable DC-balanced 2^N or standard 2^{N-1} PRBS (up to PRBS 2^{23-1})
- External pattern file (#OSP)
 - supported format: J-BERT N4903B File *.ptrn per channel
- Horizontal/Vertical Bit-pattern shift (de-correlation)

Display

- Data pattern length
- Recommended number of samples
- Recommended sampling rate (for arbitrary resampling)

Pulse shaping

- Pre-defined filter coefficients
 - Rectangular, raised cosine, root-raised cosine, Gaussian
 - Filter roll-off
- User-defined coefficients (format: CSV) (#OSP)
- FIR coefficients can be selected individually for each channel or by single selection for all

Display

- Filter response in time and frequency domain

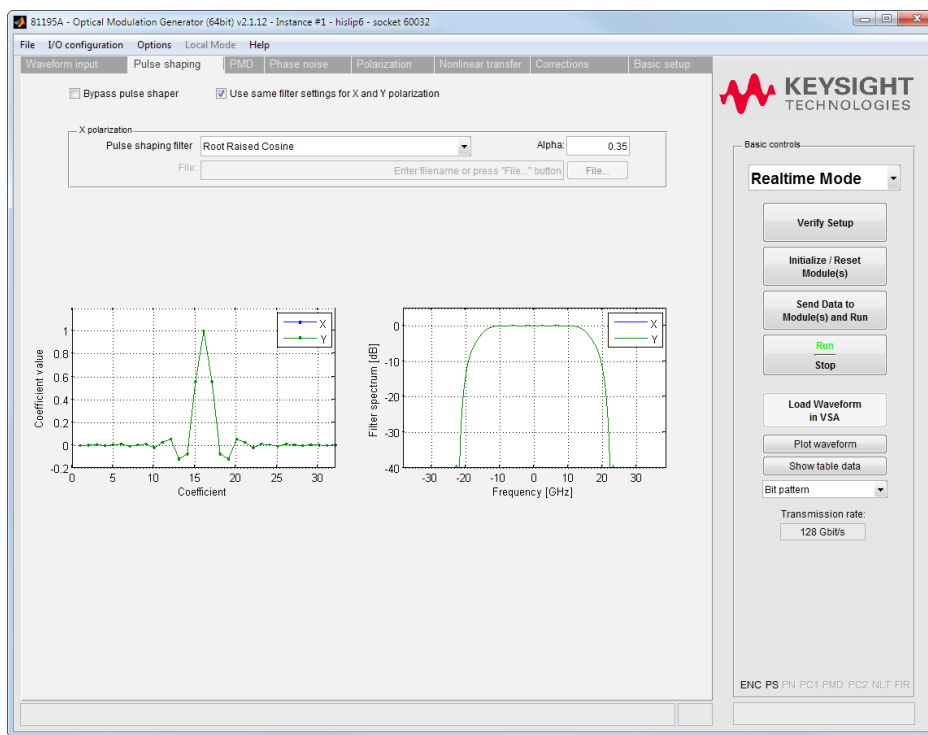

PMD emulation (#OSP)

Overview

Generally the term polarization mode dispersion (PMD) describes an optical effect that is present when light passes through a concatenation of birefringent elements. It can be represented by a vector, $\vec{\tau}$, which points in the direction of the system's slow principal state (PSP), $\hat{\rho}$ and its length is the differential group delay (DGD), τ , between the slow and the fast PSP. The PMD vector $\vec{\tau}$ itself is a frequency-dependent parameter and thus should be not mixed up with the mean differential group delay of an optical fiber, which is a statistical scalar value and also often referred to as PMD value in literature.

The vector difference between two PMD vectors $\vec{\tau}(\omega_1)$ and $\vec{\tau}(\omega_2)$ for $|\omega_1 - \omega_2| \rightarrow 0$ is defined as second-order PMD (SOPMD) vector, $\vec{\tau}_{\omega}$. Its parallel component, $\vec{\tau}_{\omega\parallel}$, is referred to as polarization-dependent chromatic dispersion (PDCD) and the perpendicular component, $\vec{\tau}_{\omega\perp}$, as depolarization.

Implementation: Emulates standard model of concatenation of birefringent elements with constant length and adjustable axis rotation and output phase. Realized with complex butterfly FIR filter structure

- 32 GBaud: Up to 7 segments/taps with 31.25 ps DGD each (at fs = 64 GSa/s)
- 16 GBaud: Up to 14 segments/taps with 31.25 ps DGD each (at fs = 64 GSa/s)

Load pre-defined states (Zero DGD, minimum pure first order, minimum first order, maximum first order, random)

Addressable PMD range (at 64 GSa/s, 32 GBaud)

- Max. DGD: 218.75 ps
- Second-order PMD: > 11000 ps²

Display

Scalar characteristics: PMD, SOPMD, depolarization, PCD

Spectral characteristics: DGD, SOPMD

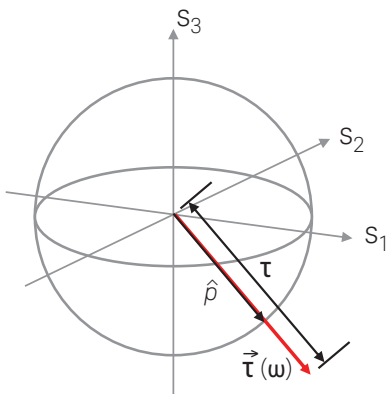

Figure 1. PMD vector in Stokes space

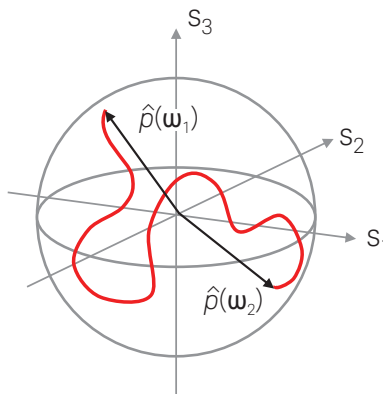

Figure 2. PSP spectrum

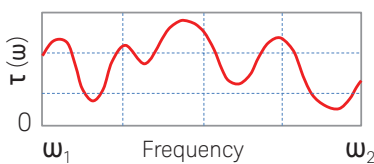

Figure 3. DGD spectrum

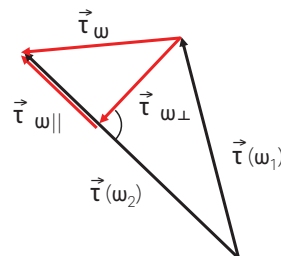

Figure 4. Definition of second-order PMD (SOPMD) vector

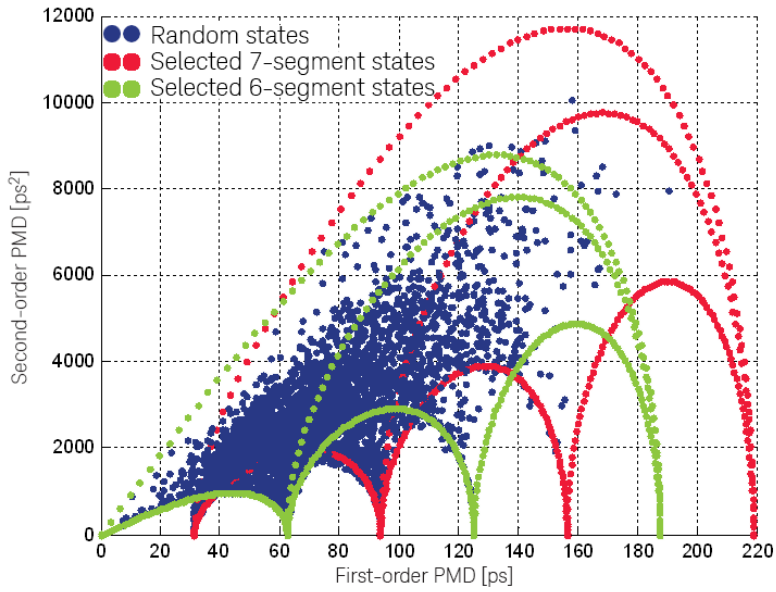
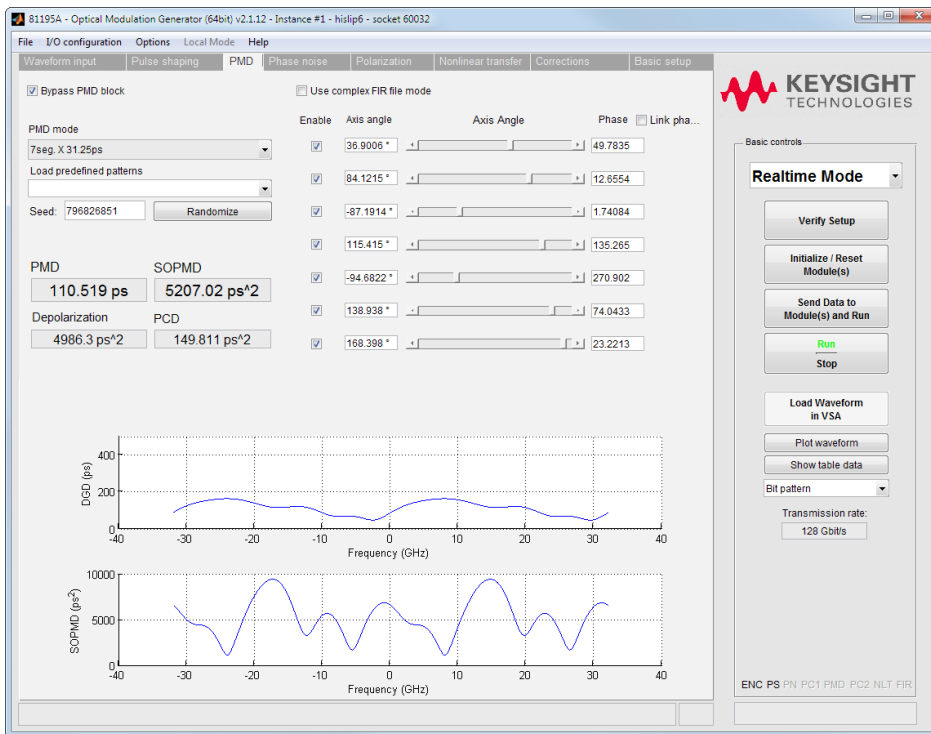

Figure 5. Addressable PMD space with DSP emulator (shown exemplary states)



Phase Noise (#OSP)

Overview

The phase noise emulation tab allows artificial phase noise to be added to the waveform thus emulating laser phase noise/jitter and/or a frequency offset by rotating a complex IQ pair. The calculation of the phase noise pattern is based on a laser phase noise model considering three contributions to the phase noise PSD. For details see paper: *Narrow Linewidth CW Laser Phase Noise Characterization Methods for Coherent Transmission System Applications*, S. Camatel, V. Ferrero, Journal of Lightwave Technology, Vol. 26, No. 17, Sept. 2008.

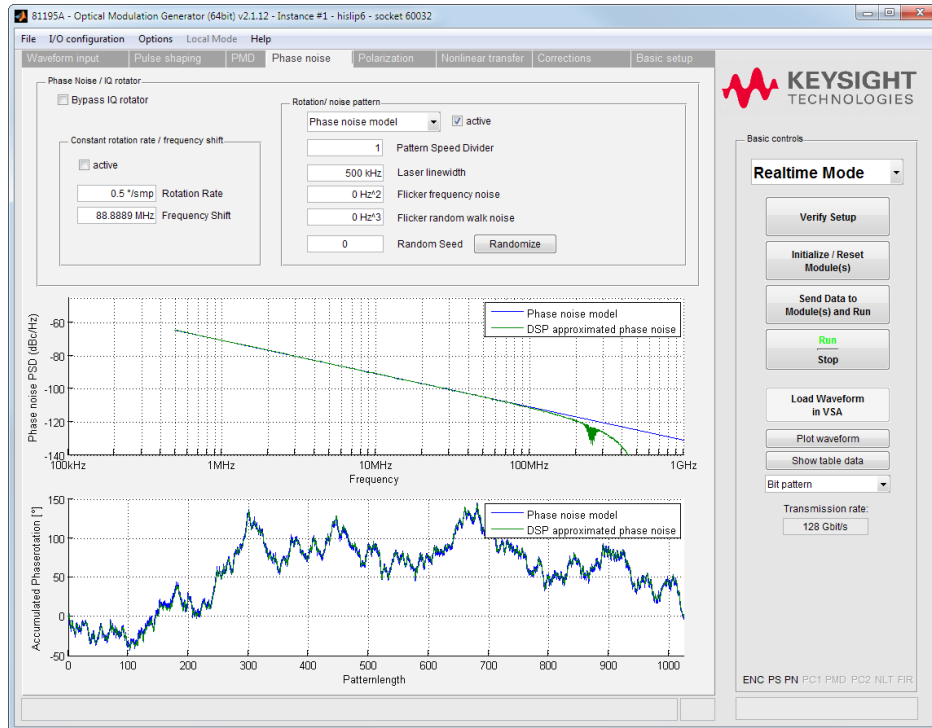

Details

- Static frequency offset
 - Range: -2.9 to +2.9 GHz
- Pattern rotation
 - Generate random phase noise pattern (parameter: linewidth, flicker noise, random walk noise)
 - Upload user-defined pattern (max. length 1024)
 - Pattern advanced rate: 7.6 kHz to 500 MHz at 64 GSa/s

Display

- Noise spectrum

Example:

For an advanced rate of 500 MHz, a phase noise spectrum is generated covering approximately three frequency decades ranging from 500 kHz to 250 MHz.

Polarization rotation (#OSP)

- Static and dynamic polarization control
- Static polarization control
 - Basic mode
 - 2 linear retarders
 - 2 circular retarders
 - Advanced mode
 - 2 complex Jones matrices
- Dynamic polarization patterns
 - Based on linear/circular retarders
 - Pre-defined pattern modes with adjustable pattern length and SOP change rate characteristics
 - Great circle
 - Spinning coin
 - Slicer
 - Upload of user-defined pattern (max. length 10240)
 - Pattern advanced rate: 1.9 kHz to 500 MHz at 64 GSa/s

Display

- SOP trajectory
- Speed characteristics (SOP pattern, SOP change rate histogram)

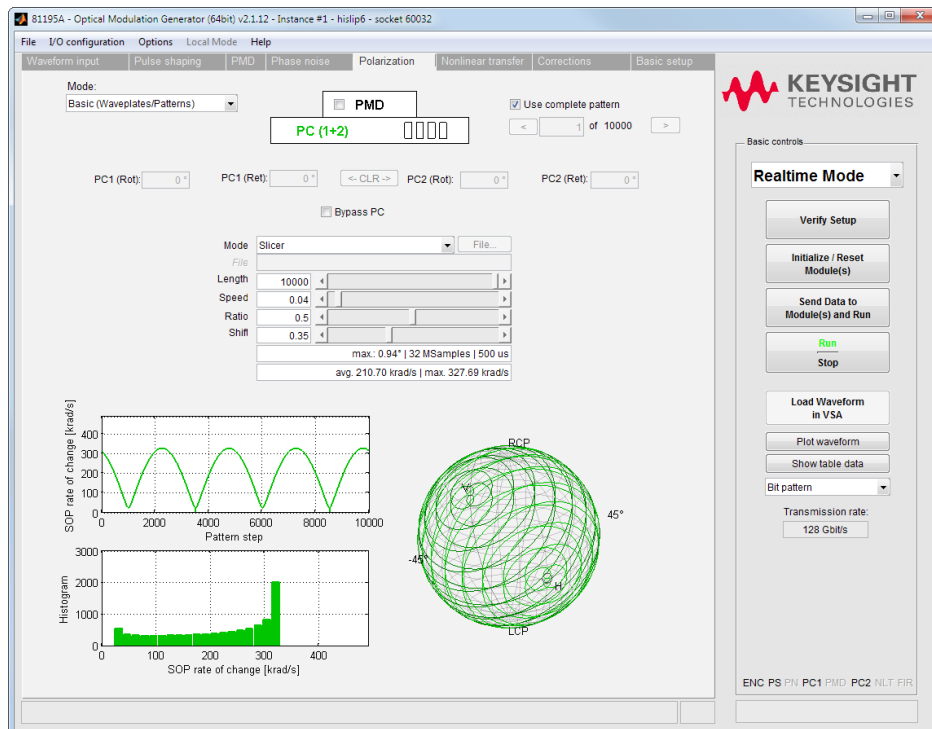

Details

The SOP rate of change is defined by the pattern type (great circle, slicer, spinning coin), the pattern length as well as the pattern play rate. Therefore, a broad range of SOP rates can be achieved by different combinations of these parameters.

At the same time, the maximum SOP angular step between two pattern entries is determined by the total pattern length. Large pattern lengths are used for small angular steps. Once a suitable angular step size has been selected, the speed setting is used to adjust the SOP rate of change and, at the same time, the pattern play time.

Example (great circle, 64 GSa/s):

Pattern length: 3600 steps
SOP angular step: 0.1°
SOP rate of change: 3.3 rad/s to 870 krad/s

While the great circle pattern gives a constant² SOP rate of change in a given plane in Stokes space, Spinning Coin mode allows for an almost constant SOP rate of change, while providing good coverage of the Poincaré sphere. The Slicer mode, on the other hand combines sphere coverage with varying rates of change.

In Dynamic mode (Pattern mode) and in Basic Static mode, polarization rotation is defined by means of two subsequent stages of both a circular and a linear (H/V) retarder. Each of the retarders covers a range of retardation of 360° at 0.25° step size. An output trigger can be configured which sends a trigger signal at the start of the rotation pattern. This can be used to start error counting in BERT or the DUT and identify the exact SOP when bit errors or system outage occur.

Note: When using PMD emulation together with polarization rotation emulation, two individual polarization control stages are available (one before and one after the PMD emulation stage) with reduced pattern capabilities.

2. The pattern will still advance in discrete steps, so the pattern parameters should be chosen for sufficiently small SOP steps.

Great circle mode
(example)

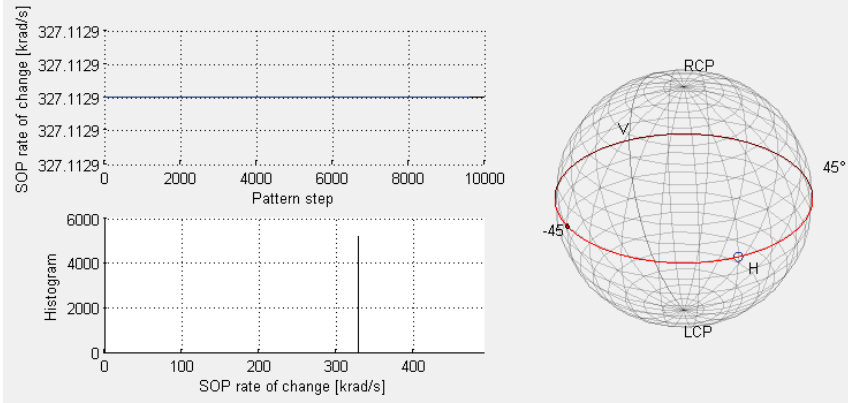

Spinning coin mode
(example)

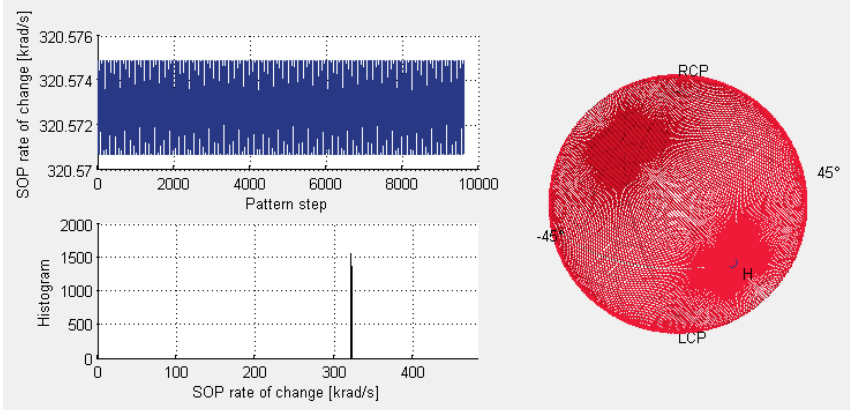

Slicer mode
(example)

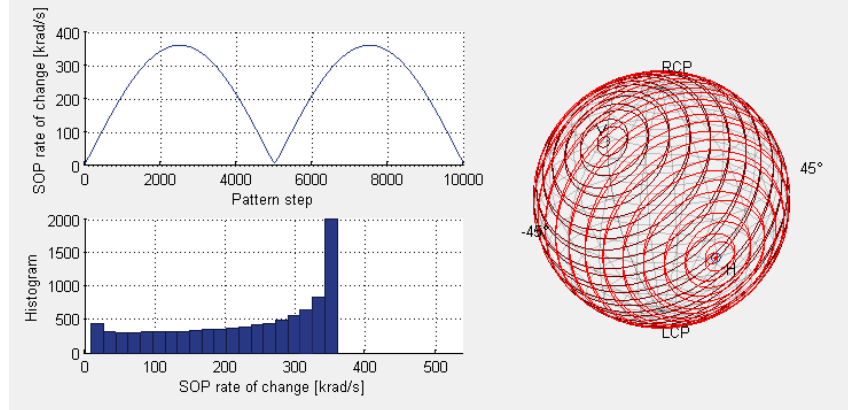

Non-linear equalizer

- Individually per channel: Selectable transfer function (broken line approximation with max. 16 segments)
- Upload of pre-defined patterns:
 - Linear (transparent)
 - Sine
 - ArcSin (inverse EO-modulator characteristic)
 - User function (#OSP)
- Upload user-defined pattern (supported format: CSV)

Display

- Transfer function

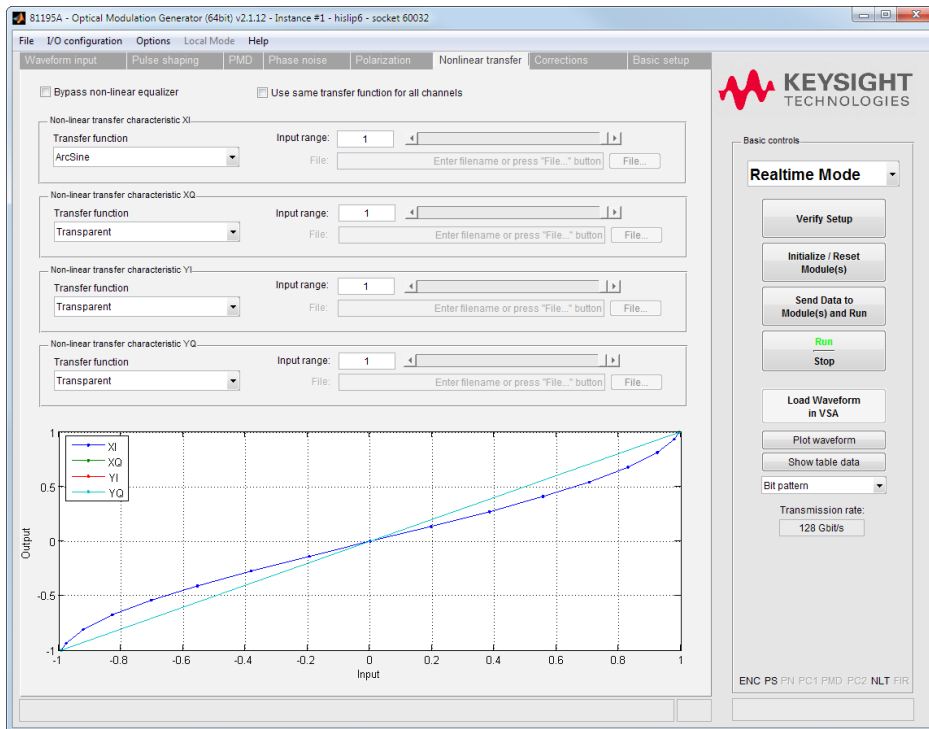

Corrections

- De-embedding of
 - AWG channel specific frequency and phase response
 - Cable loss (standard cable)
 - Skew
 - Gain imbalance
 - VSA equalizer characteristics
 - S-parameter files

Real-time mode (#RSP)

- Correction done by FIR filter in hardware DSP
 - Automatic coefficient calculation based on above de-embedding settings
 - Upload user-defined coefficients (supported format: CSV)

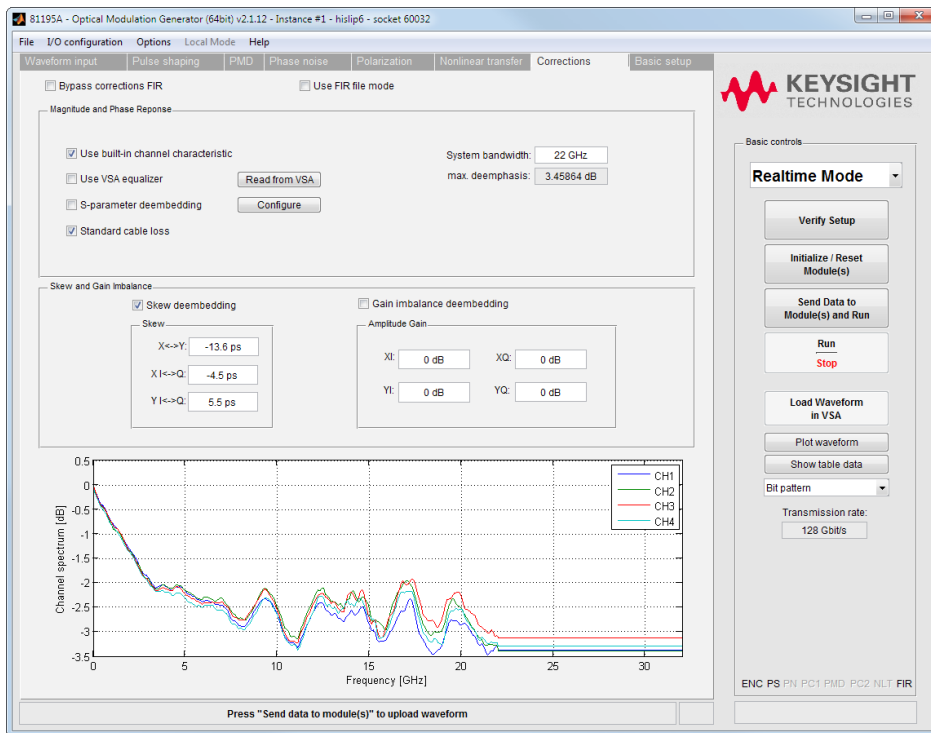

Miscellaneous

- Clock configuration (internal/external)
- Channel mapping matrix:
 - Waveform mode: User-defined assignment of XI, XQ, YI, YQ to AWG channels 1 – 4
 - Real-time mode: Fixed XI&CH1, XQ&CH2, YI&CH3, YQ&CH4
- AWG output amplitude, offset
- Trigger setup
 - Trigger-in configuration
 - Trigger-out configuration

Remote control

- Remote programming of the optical modulation generator functionality via SCPI interface
- In Real-time mode DSP coefficient memories are accessible via remote commands to allow for advanced programming

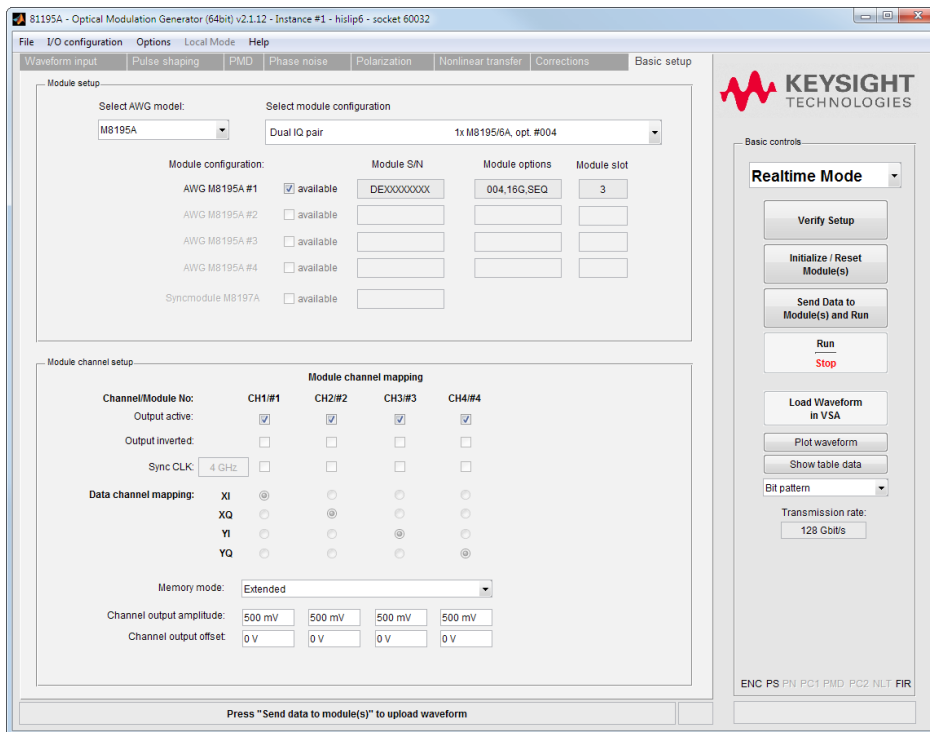

System Requirements

- 4 GB memory
- 10 GB hard disk space

Ordering Information

81195A	Optical modulation generator software
81195A – Opt. RSP	Real-time signal processing (supported on M8195A #004 or #002 only)
81195A – Opt. OSP	Optical signal properties

Learn more at: www.keysight.com

For more information on Keysight Technologies' products, applications or services, please contact your local Keysight office. The complete list is available at: www.keysight.com/find/contactus

