

Motorized Rotation Stage with Linear Motor

8MRL180

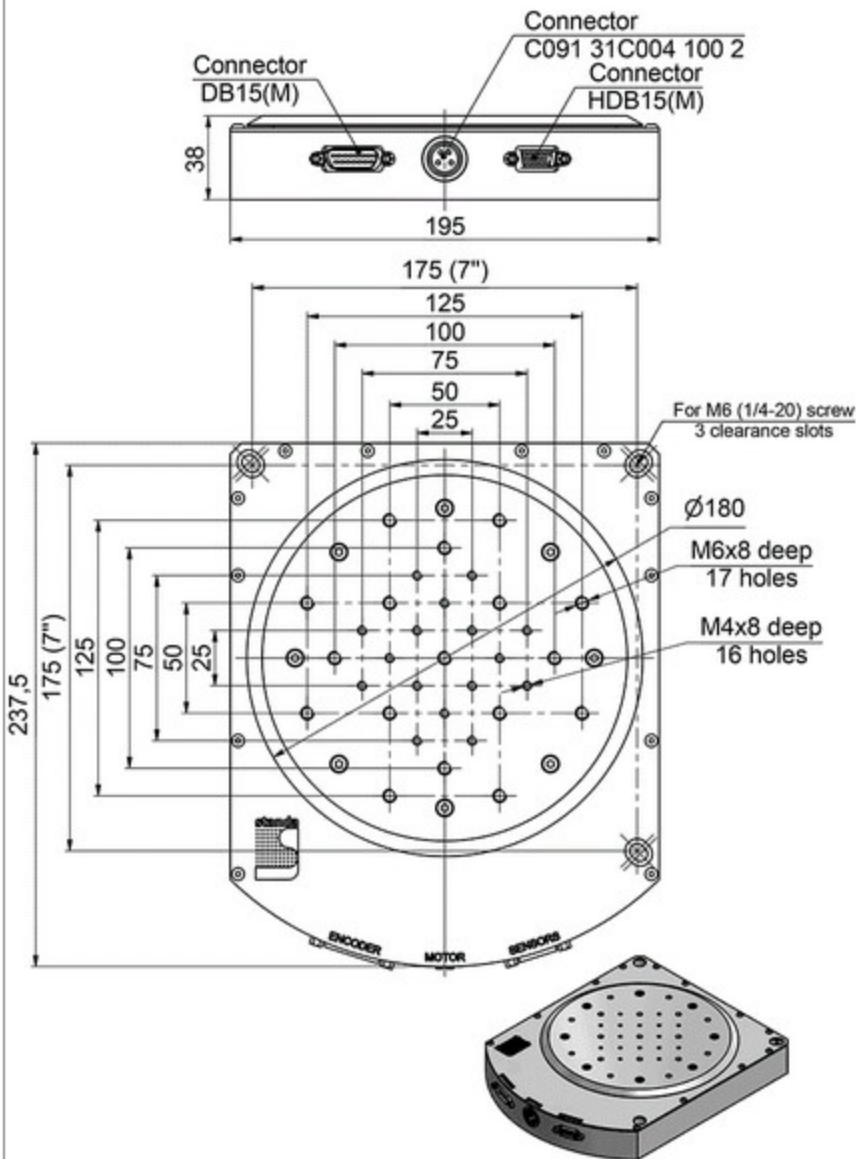

Motorized Rotation Stage with Linear Motor

8MRL250

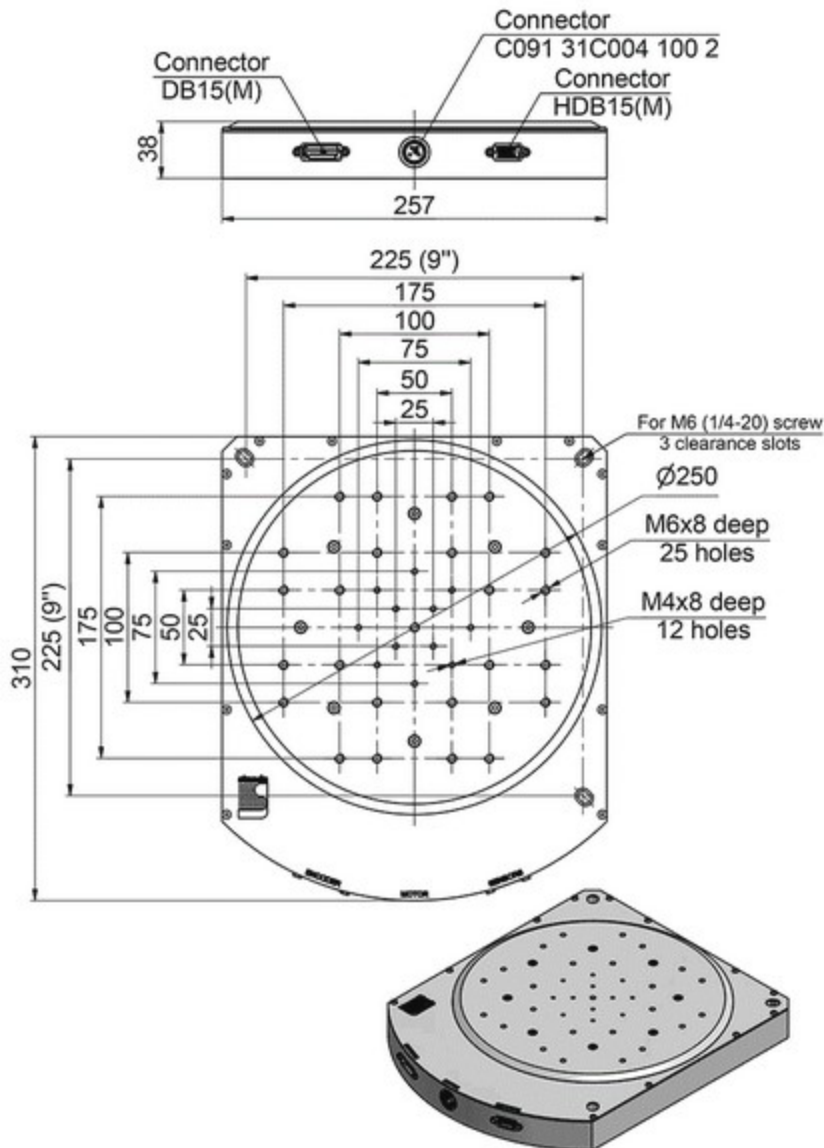



Manufacturer of Opto-Mechanical equipment for research, industry and education

P.O. Box 377
03012 Vilnius, Lithuania
Phone: +370-5-2651474
Fax: +370-5-2651483
E-mail: sales@standa.it
<http://www.standa.it>

8MRL180



8MRL250

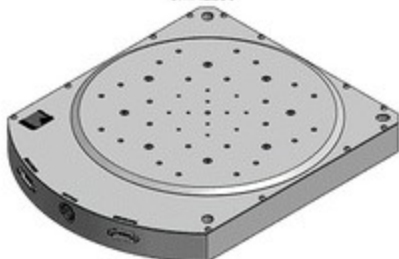

M6x9 deep
4 holes
For M6 screw
4 clearance holes

For M6 screw
4 clearance holes

M6x9 deep
4 holes

3BP8MRL180

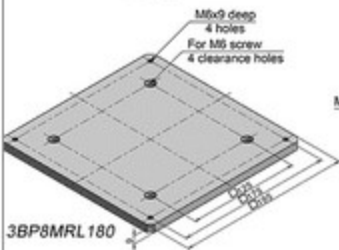

3BP8MRL250

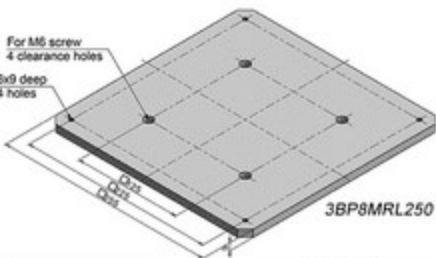

Manufacturer of Opto-Mechanical equipment for research, industry and education

P.O. Box 377
03012 Vilnius, Lithuania
Phone: +370-5-2651474
Fax: +370-5-2651483
E-mail: sales@standa.it
<http://www.standa.it>

Schematic Drawings: Direct Drive Linear and Rotation Stages Stacking

8MRL250

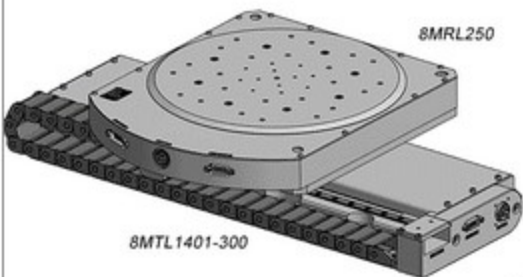

8MTL1401-300

8MRL180

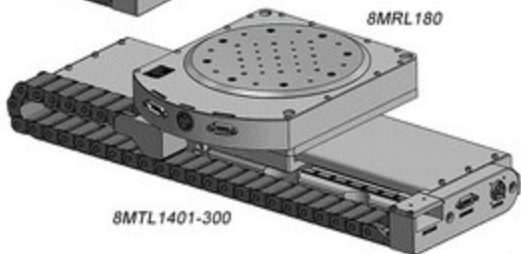

8MTL1401-300