

Keysight 81195A Optical Modulation Generator Software

User Guide

Notices

© Keysight Technologies 2018

No part of this manual may be reproduced in any form or by any means (including electronic storage and retrieval or translation into a foreign language) without prior agreement and written consent from Keysight Technologies as governed by United States and international copyright laws.

Manual Part Number

81195-91010

Edition

Edition 4.0, November 2018

Keysight Technologies Deutschland GmbH
Herrenberger Strasse 130,
71034 Böblingen, Germany

Technology Licenses

The hardware and/or software described in this document are furnished under a license and may be used or copied only in accordance with the terms of such license.

U.S. Government Rights

The Software is “commercial computer software,” as defined by Federal Acquisition Regulation (“FAR”) 2.101. Pursuant to FAR 12.212 and 27.405-3 and Department of Defense FAR Supplement

(“DFARS”) 227.7202, the U.S. government acquires commercial computer software under the same terms by which the software is customarily provided to the public. Accordingly, Keysight provides the Software to U.S. government customers under its standard commercial license, which is embodied in its End User License Agreement (EULA), a copy of which can be found at <http://www.keysight.com/find/sweula>. The license set forth in the EULA represents the exclusive authority by which the U.S. government may use, modify, distribute, or

disclose the Software. The EULA and the license set forth therein, does not require or permit, among other things, that Keysight: (1) Furnish technical information related to commercial computer software or commercial computer software documentation that is not customarily provided to the public; or (2) Relinquish to, or otherwise provide, the government rights in excess of these rights customarily provided to the public to use, modify, reproduce, release, perform, display, or disclose commercial computer software or commercial computer software documentation. No additional government requirements beyond those set forth in the EULA shall apply, except to the extent that those terms, rights, or licenses are explicitly required from all providers of commercial computer software pursuant to the FAR and the DFARS and are set forth specifically in writing elsewhere in the EULA. Keysight shall be under no obligation to update, revise or otherwise modify the Software. With respect to any technical data as defined by FAR 2.101, pursuant to FAR 12.211 and 27.404.2 and DFARS 227.7102, the U.S. government acquires no greater than Limited Rights as defined in FAR 27.401 or DFAR 227.7103-5 (c), as applicable in any technical data.

Warranty

THE MATERIAL CONTAINED IN THIS DOCUMENT IS PROVIDED "AS IS," AND IS SUBJECT TO BEING CHANGED, WITHOUT NOTICE, IN FUTURE EDITIONS. FURTHER, TO THE MAXIMUM EXTENT PERMITTED BY APPLICABLE LAW, KEYSIGHT DISCLAIMS ALL WARRANTIES, EITHER EXPRESS OR IMPLIED WITH REGARD TO THIS MANUAL AND ANY INFORMATION CONTAINED HEREIN, INCLUDING BUT NOT LIMITED TO THE IMPLIED WARRANTIES OF MERCHANTABILITY AND FITNESS FOR A PARTICULAR PURPOSE. KEYSIGHT SHALL NOT BE LIABLE FOR ERRORS OR FOR INCIDENT-

TAL OR CONSEQUENTIAL DAMAGES IN CONNECTION WITH THE FURNISHING, USE, OR PERFORMANCE OF THIS DOCUMENT OR ANY INFORMATION CONTAINED HEREIN. SHOULD KEYSIGHT AND THE USER HAVE A SEPARATE WRITTEN AGREEMENT WITH WARRANTY TERMS COVERING THE MATERIAL IN THIS DOCUMENT THAT CONFLICT WITH THESE TERMS, THE WARRANTY TERMS IN THE SEPARATE AGREEMENT WILL CONTROL.

Safety Notices

CAUTION

A CAUTION notice denotes a hazard. It calls attention to an operating procedure, practice, or the like that, if not correctly performed or adhered to, could result in damage to the product or loss of important data. Do not proceed beyond a CAUTION notice until the indicated conditions are fully understood and met.

WARNING

A WARNING notice denotes a hazard. It calls attention to an operating procedure, practice, or the like that, if not correctly performed or adhered to, could result in personal injury or death. Do not proceed beyond a WARNING notice until the indicated conditions are fully understood and met.

Contents

1 Introduction

Product Overview	10
Key Features	10
Options	11
Supported Instruments	12
Installation	13
Prerequisites	15
MATLAB Compiler Runtime	16
M8194/5/6/7A Firmware and Soft Front Panel	16
89601B VSA Software	16
N4391A/N4392A/N4391AU Optical Modulation Analyzer	17
IO Libraries Suite	17
Licenses	18
Open Source Components	19

2 Getting Started

Getting Started	22
------------------------	----

3 Waveform and Real-Time Operation

Waveform Creation Modes	26
Real-time DSP Engine	27
Important Information regarding Waveform and Real-time Mode	37

4 81195A User Interface

Launching the 81195A Optical Modulation Generator Software	42
-------------------------------------------------------------------	----

Entering Data	46
Units	46
Metric Prefixes	46
Limits	47
Cursor Keys and Mouse-Wheel	47
Sliders and Numeric Controls	47
81195A User Interface Overview	48
Title Bar	49
Menu Bar	49
Instrument VISA setup	55
Clock Setup	61
Trigger Setup	64
Basic Controls Bar	70
Status / Warning / Error Bar	75
Configuration Tabs	77

5 Data Signal Impairment and Hardware Configuration Tabs

Data Signal	80
Waveform Input	80
Waveform Input (Complex modulated waveform mode)	82
Data Pattern	92
Waveform Input (Standard waveform mode)	95
Waveform Input (Load external waveform)	97
Pulse Shaping	98
Theory	98
Pulse Shaping	100
Polarization Mode Dispersion (PMD)	103
Theory	103
Polarization Mode Dispersion (PMD)	106
Polarization Mode Dispersion (PMD) – User defined coefficients	110

Phase Noise / IQ Rotation	112
Theory	112
Phase Noise / IQ Rotator Tab	113
Phase Noise (User defined pattern)	118
Polarization	120
Theory	120
Polarization Tab	127
Polarization (Basic (Waveplate / Patterns) mode without PMD)	129
Polarization (Basic (Waveplate / Patterns) mode with PMD)	134
Polarization (Advanced (Jones-Matrices) mode without PMD)	137
Polarization (Advanced (Jones-Matrices) mode with PMD)	139
Nonlinear Transfer Characteristics	141
Theory	141
Nonlinear Transfer Characteristics	142
Corrections	146
Theory	146
Corrections	147
S-Parameter deembedding	154
Corrections (Use FIR file mode)	156
Basic Setup	158
Basic Setup	158

6 General Programming

SCPI Programming Overview	166
Introduction	166
General	166
Visa Resource Names and LAN interfaces	167
HiSLIP protocol	168
Socket protocol	168
Identifying the 81195A OMG software instance	168
Timeout settings	169
Reading and clearing error messages	169
Local mode and remote operation	169
Example Program	169
SCPI Programming Reference	171
CHANnel Subsystem	177
CORRections Subsystem	181
PULSeshaper Subsystem	190
SETTings Subsystem	194
SETUp Subsystem	199
SPRoperties Subsystem	224
WAVEform Subsystem	259

7 File Formats and Example Files

Example Files	278
General Properties of ASCII / CSV Files	278
Waveform file	278
User-defined modulation file	279
Data pattern file	280
Pulseshaper file	280
PMD FIR filter coefficient file	281
Phase Noise / IQ rotator pattern file	281
Polarization Controller pattern file	282
Nonlinear transfer characteristics file	283
Correction FIR coefficient file	284

8 Literature

Keysight 81195A Optical Modulation Generator
Software

User Guide

1 Introduction

[Product Overview](#) / 10

[Installation](#) / 13

[Prerequisites](#) / 15

[Licenses](#) / 18

Product Overview

The Keysight Technologies 81195A Optical Modulation Generator software allows you to generate dual-IQ, complex modulated signals, as well as emulate optical signal properties and signal impairments such as phase noise, polarization rotation, and polarization mode dispersion (PMD).

The latest arbitrary waveform generators offer sampling rates that enable you to directly synthesize and generate complex modulated base band signals with the highest data rates, driving electrical/optical (E/O) converters and generating a true optical transmission channel with 256 Gb/s and beyond.

With the 81195A optical modulation generator software a new approach in receiver stress testing is possible. The software allows users to electronically synthesize, and deterministically modify, optical signal properties such as phase noise, polarization, or PMD by electronic means at runtime.

In traditional fiber transmission and optical receiver testing, which uses optical elements for stress conditioning, the stress conditions can only be changed in a stochastic way, resulting in long test times.

In contrast, this new test approach allows you to generate and reproduce dynamic stress conditions with precise time evolution or stress statistics, increasing test coverage and reducing test time. The 81195A software, in conjunction with a four-channel Keysight Technologies M8194A, M8195A or M8196A arbitrary waveform generator, can generate clean signals and signals stressed with impairment patterns. The digital signal processing (DSP) block inside the M8195A allows the parameters of the waveform (e.g. the pulse shaping filter coefficients) and impairment generation to be adjusted at run-time without downloading a new waveform. The real-time waveform generation allows deterministic emulation of optical signal properties over a long period of time, which previously has not been possible.

Key Features

- Waveform calculation for dual-polarization, complex modulated signals (up to 256QAM) via 81195A software offline, or using the M8195A hardware DSP block

- Effective use of the available M8195A module memory in real-time waveform generation mode for complex modulated signals (up to 8 GSym per channel on two IQ channels simultaneously at up to 32.5 GBaud)
- Realistic emulation of optical signal properties and impairments, including phase noise, polarization mode dispersion, and polarization rotation over a long period of time
- Change signal properties, 'on-the-fly' without needing to re-calculate the entire waveform (saves valuable time during debug and characterization)
- Output triggers synchronized with impairment generation
- User-accessible DSP coefficients
- Corresponding analysis capabilities in the Keysight Technologies N4391A/N4392A optical modulation analyzer

Options

The product structure of the 81195A Optical Modulation Generator software is divided into:

- Base functionality / waveform mode (does not require any option)
- Optical signal properties and user defined modulation formats / pulse shaper filters (requires option #OSP)
- Real-time signal processing/real-time mode (requires option #RSP)

Table 1 **81195A options**

Product Number	Description
81195A-OSP	Optical Signal Properties, such as PMD, Polarization Controller, etc.
81195A-RSP	Real-time Signal Processing

Without a valid #OSP license, all optical signal properties / impairment tabs will be disabled, as well as certain other controls, such as those for user-defined pulse shaping and user-defined modulation formats.

Without a valid #RSP license, the 81195A software cannot be set to real-time mode. It can be used in waveform mode without restrictions, though.

Supported Instruments

The 81195A Optical Modulation Generator software supports the following AWG hardware:

- M8194A: M8194A modules with option #002, #004
- M8195A Rev.2 modules with option #002, #004 and minimum FW Rev. 2.0.3.0
- M8196A: M8196A modules with option #002, #004
- M8197A: M8197A modules

Installation

The 81195A Optical Modulation Generator (OMG) software is installed through the Keysight Photonic Applications Package Manager, called Package Manager throughout this document.

The Package Manager can be downloaded from <http://www.keysight.com/find/81195A> web page under tab “Trials & Licenses”.

It is also installed as part of an M8195A software installation and can be found in the Windows Start Menu under *All Programs – Keysight M8195 – Install or Update Optical Modulation Generator Software*.

It will automatically check for the latest available version of the 81195A OMG software and other required software packages, as long as an internet connection is available.

The Package Manager, shown in the [Figure 1](#) on page 14, is used for other Keysight photonic applications as well, so you may have to switch to the OMG tab (1) to see the actual OMG related packages. This will happen automatically, when the Package Manager is launched from the 81195A OMG software’s help menu or the M8195A software’s start menu folder.

Find the 81195A OMG software entry (2) and either check the release notes for the package, which will be shown in the section to the right (3) while hovering the mouse cursor over the package entry (2) or perform the next available Action (4) for the package:

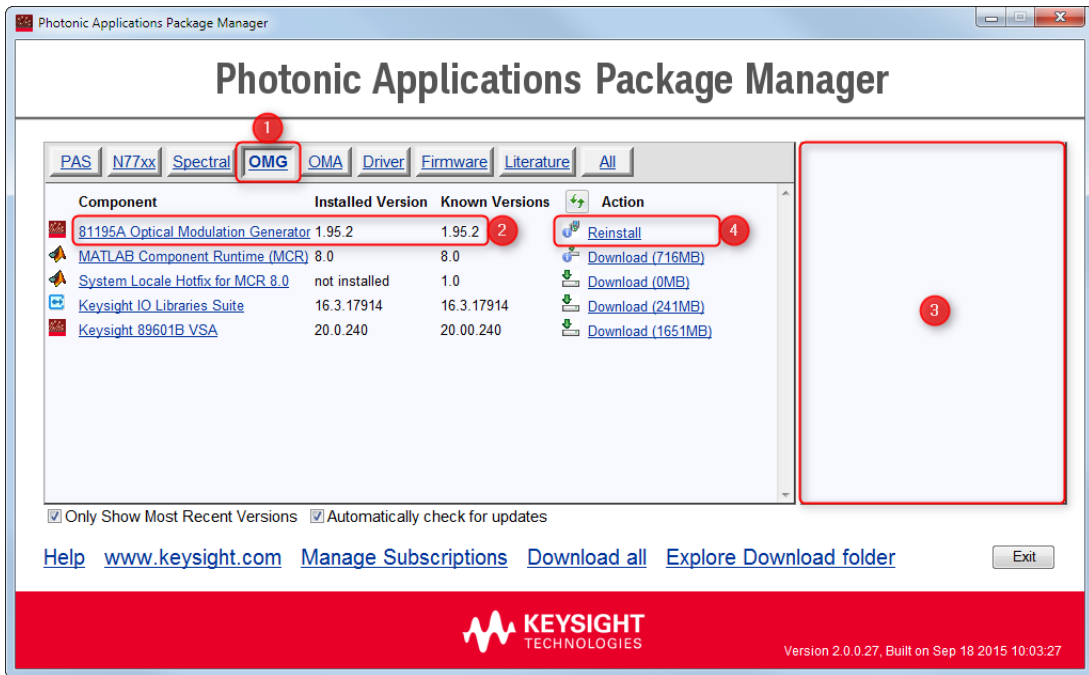

Figure 1 Photonic Applications Package Manager

When the Package Manager is started for the first time, the *Action* will be *Download*. Once the package is downloaded, it will change to *Install*. Once successfully installed it will change to *Reinstall*. This will just start the installer once again. It does not mean that a reinstallation is actually required.

Most packages shown in the Package Manager have some prerequisites. A few of them are required to be installed before the package that has just been selected for installation. If so, the Package Manager will take care of installing them in the appropriate sequence then starting the installer of the actually selected package. Others are not required before the installation, but before an installed program may be used. In that case, the selected program can be installed right away, but animated icons will indicate missing dependencies afterwards.

Required dependencies for the 81195A are the Mathworks MATLAB Compiler Runtime (MCR) and the Keysight IO Libraries Suite. Both of them may be installed after installing the 81195A software itself.

Prerequisites

The 81195A OMG software has a number of mandatory and a number of optional prerequisites.

Mandatory Software:

- 81195A Optical Modulation Generator software
- Mathworks MATLAB Compiler Runtime (MCR 8.0)
- Keysight IO Libraries Suite
- M8194A, M8195A, or M8196A Soft Front Panel, M8197A Soft Front Panel for multi module setup

Optional Software:

- 89601B Vector Signal Analysis software running on a Real time Oscilloscope, PC, or in combination with N4391A or N4392A Optical Modulation Analyzer

M8197A Soft Front Panel, in case multiple M8195A modules are to be used in a multi module setup.

The OMG Software will not start without the MCR package being installed and also requires the IO Libraries Suite package to be installed. Both of these requirements are handled by the Package Manager (see [Installation](#) on page 13). MCR and IO Libraries Suite packages do not need a separate license.

In case the 81195A OMG software is used purely for visualizing data within the 81195A OMG software or for generating waveform files to be used on a different PC, there are no further prerequisites.

In case it is used to generate waveforms for analysis in the 89601B Vector Signal Analysis software (VSA, a separate license is required), this software (see [Launching the 81195A Optical Modulation Generator Software](#) on page 42) needs to be installed as well. It does not have to be installed on the same PC, though. See section [Instrument VISA setup](#) on page 55 on how to configure the 81195A software for communication with the 89601B VSA software.

In case the 81195A OMG software is used in conjunction with an AWG module, the M8194/5/6/7A Firmware and Soft Front Panel (see [MATLAB Compiler Runtime](#) on page 16) needs to be installed as well. It does not have to be installed on the same PC, though. See section [Instrument VISA setup](#) on page 55 on how to configure the 81195A software for communication with the M8194/5/6/7A Firmware and Soft Front Panel.

In addition, a VSA installation might be necessary, in case frequency corrections based on the VSA equalizer are to be employed (see [Corrections](#) on page 147).

MATLAB Compiler Runtime

The MathWorks MATLAB Compiler Runtime is a library package required for running the 81195A OMG software.

M8194/5/6/7A Firmware and Soft Front Panel

The M8194/5/6/7A Firmware and Soft Front Panel serves as firmware for the actual AWG modules. Thus, it needs to be installed on the PC that the AWG mainframe is physically connected to (either by USB or PCIe). After starting the M8194/5/6/7A Firmware and Soft Front Panel, you can connect to the desired AWG module by selecting it from a list.

The 81195A OMG software may be installed on the same PC but it doesn't have to be.

See [Instrument VISA setup](#) on page 55 on how to configure the 81195A software for communication with the M8194/5/6/7A Firmware and Soft Front Panel.

For more information about the M8194/5/6/7A Firmware and Soft Front Panel please read the respective User's Guides.

89601B VSA Software

The 89601B Vector Signal Analysis software, called VSA throughout this document, is used to analyze modulated data signal with a real-time oscilloscope or with an optical modulation analyzer. It can be operated in vector mode using real or complex input channels and it comprises powerful demodulation schemes for more detailed signal analysis, especially the error vector magnitude (EVM).

To access the full range of analysis features, especially when dealing with actual optically modulated signals or with their electrical equivalent, the N4391A/N4392A Optical Modulation Analyzer software (see [N4391A/N4392A/N4391AU Optical Modulation Analyzer](#) on page 17) should be used.

N4391A/N4392A/N4391AU Optical Modulation Analyzer

The Keysight Optical Modulation Analyzer (OMA) is available as measurement instruments (N4391A/N4392A), as well as a standalone software version (N4391AU), to be used with an oscilloscope or to analyze measurement data files.

The OMA will enhance the VSA base functionality by adding many analysis functions (e.g. BER analysis), as well as many algorithms to be used for compensation and analysis of optical impairments, such as phase noise, polarization rotation, PMD and much more.

See www.keysight.com/find/OMA for further details on these products.

IO Libraries Suite

The IO Libraries Suite provides the VISA communication libraries. It needs to be installed to enable communication with AWG modules (through the M8194/5/6/7A Firmware and Soft Front Panel) or to the VSA software.

For the 81195A OMG software to be able to communicate with M8194A/5A/6A/7A instruments (i.e., their respective Soft Front Panels) and the 89601B VSA software, it may be required to add them to the Connection Expert first.

The *Connection Expert* is part of the IO Libraries Suite and can be accessed by double-clicking the IO Libraries suite icon in the system tray.

Please see the IO Libraries Suite help for additional details on how to add LAN instruments.

Licenses

As described in the section **Options** on page 11, certain features of the 81195A OMG software are tied to specific options. Each of these options needs to be enabled on a given PC by installing the corresponding license. If there's no license installed, the 81195A OMG software will start with a basic feature set (Waveform mode only, no optical signal properties / impairment generation).

Features unavailable due to missing licenses will be disabled in the graphical user interface.

Licenses are installed, moved and verified through the Keysight License Manager, which is part of the 81195A OMG installer but which may also have been installed by another Keysight software package before.

You can start the Keysight License Manager from the start menu (*All Programs – Keysight License Manager – Keysight License Manager*). In case the Keysight License Manager is already running, you can open it by double clicking the yellow lock symbol in the system tray.

By ordering one or more of the 81195A options from section **Options** on page 11, you will receive a certificate, entitling the redemption of one or more licenses.

NOTE

The certificate document contains information on where and how to redeem your license(s).

By redeeming the license you will receive a license file that can be installed by selecting *File – Install...* in the Keysight License Manager, then pointing to the license file. It is also possible to copy the whole text from the license file to the clipboard then paste it into the Keysight License Manager window.

During license redemption, one purchased license will be bound to a specific PC, but it is possible to transport the license at a later time, to be used on a different PC instead.

Please see the Keysight License Manager Help for additional details on how to install and transport licenses.

Open Source Components

The 81195A software uses a number of open source components. Their respective license files can be found in the “Open Source” subfolder of the 81195A OMG software installation folder. For a default installation this would be *C:\Program Files\Keysight\Optical Modulation Generator\Open Source*.

Keysight 81195A Optical Modulation Generator
Software

User Guide

2 Getting Started

Getting Started / 22

Getting Started

This section will give an overview of the essential steps for first time use of the 81195A OMG software for generating waveforms for an AWG module. Please note that many additional important notes are covered in the specific sections of this document, which are omitted in this brief overview.

This overview assumes that the 81195A OMG software is used to generate waveforms using an AWG module.

- 1 Make sure the 81195A has been installed correctly (see [Installation](#) on page 13), as well as any required and desired prerequisites (see [Prerequisites](#) on page 15).
- 2 Power up and connect the AWG mainframe using USB or PCIe to a PC. Make sure that the M8194/5/6/7A Firmware and Soft Front Panel is installed on that PC. This does not have to be the same PC as the one running the 81195A OMG software. If it is not, both PCs must be connected through a LAN connection.
- 3 Start the M8194/5/6/7A Firmware and Soft Front Panel on the PC connected to the AWG module.
- 4 In the Soft Front Panel, select a supported AWG module from the list of detected instruments then press the Connect button. Note that the M8194/5/6/7A Firmware and Soft Front Panel may list AWG modules that are not supported by the 81195A OMG software and, thus, should not be selected.
- 5 Start the 81195A OMG software (see [Launching the 81195A Optical Modulation Generator Software](#) on page 42).
- 6 From the I/O Configuration menu, open the *Instrument VISA Setup* dialog and configure VISA addresses for the AWG module (see [Instrument VISA setup](#) on page 55).
- 7 Switch to the *Basic Setup* tab to verify or change the module setup configuration, i.e., two channel or four channel setup (see [Basic Setup](#) on page 158) and whether you are working with one or more M8195A or with an M8194A/M8196A.
- 8 Click the *Verify Setup* button (see [Verify Setup](#) on page 70) to make sure instrument communication is working correctly.
- 9 Click the *Initialize / Reset Module(s)* button (see [Initialize / Reset Module\(s\)](#) on page 71) to prepare the instrument.
- 10 Switch to the *Waveform Input* (see [Waveform Input](#) on page 80) and the *Pulse Shaping* (see [Pulse Shaping](#) on page 100) tabs to verify or configure the clean signal settings.

- 11 Switch to the Corrections tab (see [Corrections](#) on page 147) and make sure the desired corrections are active and the corrections FIR is not set to bypass.
- 12 If you have option #OSP installed, have a look at the DSP / Optical Signal Properties Stage Indicator (see section **DSP / Optical Signal Properties Stage Indicator** on page 74) to make sure only the desired stages are active. Switch to the respective tabs to configure the individual stages.
- 13 Set the instrument to Waveform or Real-time mode (see section **Waveform / Real-time Mode Selector** on page 71) as desired (and depending on installed licenses).
- 14 Click the Send Data to Module(s) button (see section **Send Data to Module(s)** on page 72) to transfer the waveform or symbol pattern to the AWG module and start playback.
- 15 Afterwards, when operating in Real-time mode, most changes in the GUI will have an immediate effect on the generated signal. When operating in Waveform mode, the Send Data to Module(s) button has to be clicked again to transfer a waveform based on changed settings to the AWG. See section [Important Information regarding Waveform and Real-time Mode](#) on page 37 for differences between Waveform and Real-time mode.

If installation and configuration is correct (configuration will be saved automatically upon exiting the 81195A OMG software), and if the AWG is powered up and connected to a running M8194/5/6/7A Firmware and Soft Front Panel, it will be sufficient to use the following few steps for generating a waveform:

- 1 Start the 81195A OMG software (see section [Launching the 81195A Optical Modulation Generator Software](#) on page 42).
- 2 Click the Verify Setup button (see section **Verify Setup** on page 70) to make sure instrument communication is working correctly.
- 3 Click the Initialize / Reset Module(s) button (see section **Initialize / Reset Module(s)** on page 71) to prepare the instrument.
- 4 Click the Send Data to Module(s) button (see section **Send Data to Module(s)** on page 72) to transfer the waveform or symbol pattern to the AWG module and start playback.
- 5 Afterwards, when operating in Real-time mode, most changes in the GUI will have an immediate effect on the generated signal. When operating in Waveform mode, the Send Data to Module(s) button has to be clicked again to transfer a waveform based on changed settings to the AWG. See section [Important Information regarding Waveform and Real-time Mode](#) on page 37 for differences between Waveform and Real-time mode.

Keysight 81195A Optical Modulation Generator
Software

User Guide

3 Waveform and Real-Time Operation

[Waveform Creation Modes](#) / 26

[Real-time DSP Engine](#) / 27

[Important Information regarding Waveform and Real-time Mode](#) / 37

Waveform Creation Modes

The 81195A software provides two means of generating waveforms. As shown in the [Figure 2](#) on page 26, in the waveform mode the software creates waveforms using software algorithms. In contrast to this, the real-time mode uses the M8195A hardware DSP block to create the waveforms.

NOTE

Real-time operation is only available when using M8195A single module setups.

Waveform Mode

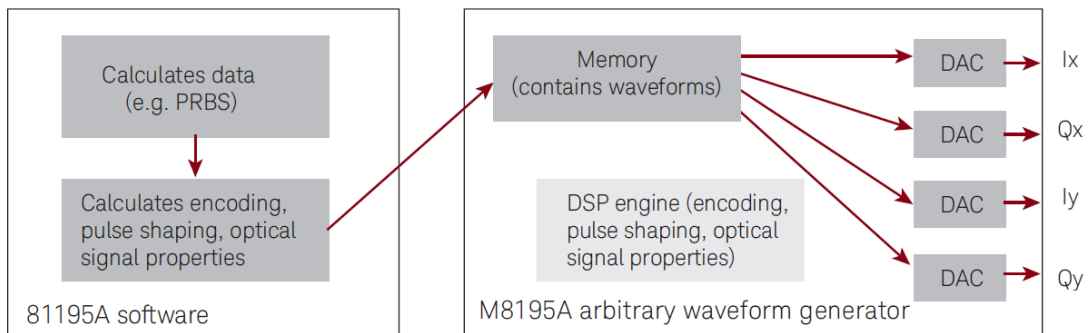

Figure 2 Illustration of Waveform Mode operation

Real-time Mode

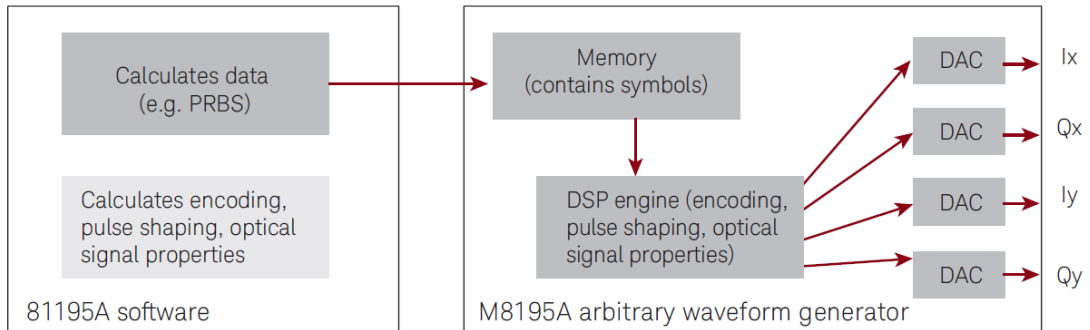

Figure 3 Illustration of Real-time Mode operation

Each method has distinct benefits:

In waveform mode

- A wide range of symbol rates are available (real-time mode is limited to certain ranges)
- Symbol rate with non-integer number of samples per symbol can be generated using waveform re-sampling.

In Real-time mode

- Signal properties like pulse shaping parameters and signal impairments can be modified at run-time without need for re-calculating and re-downloading a new waveform, significantly reducing test time
- Real-time operation allows signal property generation and variation, such as polarization rotation, either as fast transients or slowly changing effects over a long period of time.
- Trigger output, which is aligned with the signal impairment pattern, can be used to synchronize test equipment, e.g. time-to-error measurement with BERT

Real-time DSP Engine

The real time DSP engine on the AWG chip of the M8195A arbitrary waveform generator consists of a fixed concatenation of pre-defined DSP functions and FIR filters, with programmable coefficients. Coefficient memories of various sizes are available to change the DSP characteristic

upon external triggering or according to a repetitive dynamic impairment pattern. Output triggers are generated in sync with the coefficient patterns.

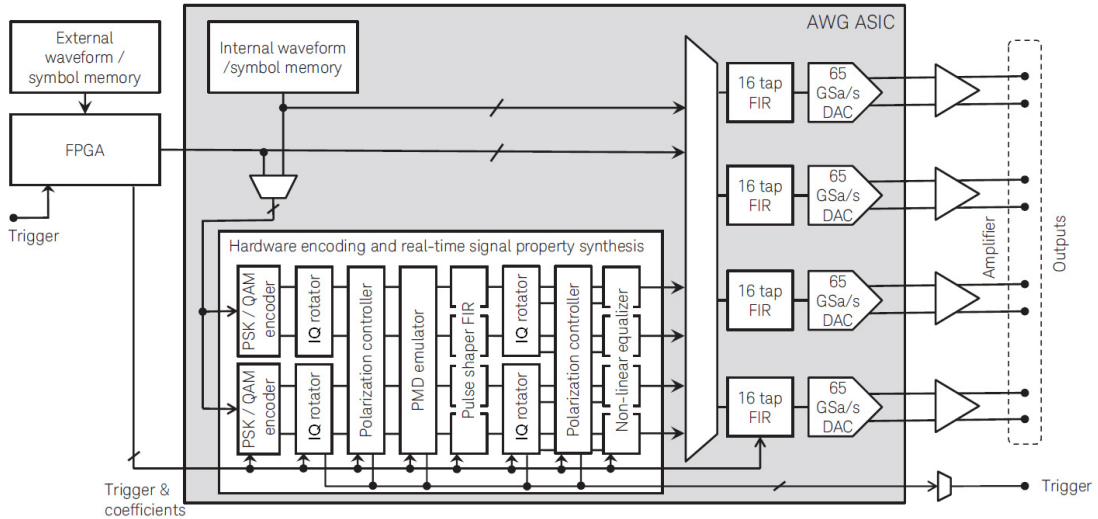

Figure 4 Block diagram of AWG / DSP architecture

PSK/QAM encoder

In real-time DSP operation, the AWG memory stores the data pattern symbols which are then encoded using the PSK/QAM encoder based on reconfigurable look-up tables (LUT), instead of storing the pre-calculated waveform samples of the desired signal.

IQ rotator

The IQ rotator consists of two identical blocks where an instantaneous rotation angle, controlled from a pre-programmed coefficient pattern memory, is applied to the complex IQ signal for both the X and Y polarization, emulating, for example, carrier phase noise or a frequency offset.

Polarization controller

Each polarization controller is a one-tap butterfly filter and alters the state of polarization (SOP) by acting like a concatenation of a circular and linear retarder. Rotation angle and retardation can be controlled from a pre-programmed pattern memory, which allows complex SOP trajectories on the Poincare sphere to be synthesized. One polarization controller (first stage) is positioned in front of the PMD emulator, so the input state of polarization to the emulator can be synthesized. Another polarization controller is positioned after the PMD emulator, so the relative state of polarization between the PMD emulator and the receiver can be synthesized.

PMD emulator

Based on the model of multi-segment concatenation of birefringent elements, the Polarization Mode Dispersion emulator block is a complex FIR butterfly structure in which its filter coefficients represent the optical channel's PMD impulse response.

Pulse shaper FIR

For a spectrally efficient transmission channels, the data symbols can be filtered with a general 16-tap FIR filter to flexibly vary the pulse shaping such as raised or root-raised cosine or the roll-off factor.

Non-linear equalizer

The non-linear equalizer applies a (static) non-linear transfer function based on a broken line approximation algorithm to the data signal, allowing, for example, to compensate for the transfer characteristic of an electro-optical modulator.

Correction FIR

For either correcting frequency response characteristics of the electrical/electro-optical setup or for general purpose applications, there is a 16-tap FIR filter available per channel.

Input and Output Triggers

Using the 81195A OMG software, trigger signals can be used to start symbol pattern playback as well as optical signal property /impairment pattern playback when using real-time mode. Output trigger signals can be generated as well.

This section describes the general structure and behavior of the 81195A OMG triggering system. Please see section [Trigger Setup](#) on page 64 for details on the GUI representation.

NOTE

M8194A and M8196A instruments do not support trigger operation.

NOTE

M8195A instruments support impairment trigger operation only in real-time mode, i.e., only for single module setups and only with the 81195A-RSP option.

NOTE

Trigger configuration is not immediately updated on the instruments. It is updated by clicking the respective Apply button or the next time Send Data to Module(s) and Run is clicked.

Trigger Types

Trigger In Connector

The Trigger In Connector trigger can be used to start symbol pattern playback as well as playback of optical property / impairment patterns. It is possible to start either of the two, both or neither of them by the Trigger In Connector.

NOTE

The Trigger In Connector starts DSP stage pattern playback asynchronously, i.e., at the time the trigger slope is registered at the input connector. If the Trigger In Connector is selected to start symbol pattern playback as well as DSP stage pattern playback, symbol pattern playback will start with a certain delay, as well as an uncertainty of one clock cycle. To start playback for symbol pattern and DSP pattern in a synchronous manner, use the Waveform Trigger instead.

Waveform Trigger

The waveform trigger can be used to start symbol pattern playback as well as playback of optical property / impairment patterns. It is possible to start either of the two, both or neither of them by the Waveform Trigger.

The Waveform Trigger is generated inside the AWG instrument(s) and can be configured to be initiated by a trigger input signal at the Trigger In Connector (labeled TRIG IN) or to be automatically generated at a user-defined repetition rate between 0.1Hz and 17.85MHz. In addition, a trigger signal can be generated manually by either clicking the respective button in the waveform trigger configuration section of the GUI or by sending the respective SCPI command.

If the Trigger In Connector is used as a trigger source, the respective slope, threshold and mode of operation can be configured. See *M8195A User's Guide* for further details.

NOTE

The Waveform Trigger is generated internally, synchronous to the start of the symbol pattern playback. Using the Waveform Trigger it is therefore possible to have DSP patterns start with a fixed temporal relationship to the symbol pattern data.

Software Trigger

The software trigger can be used to manually start optical property / impairment pattern playback. This trigger is generated by either clicking the respective button in the impairment trigger configuration section of the GUI or by sending the respective SCPI command.

Output Trigger

Optical signal property / impairment DSP stages as well as the Waveform and the Software Trigger can be configured to generate output trigger signals. These are available at the front panel connector labeled EVENT IN. The high and low level of the generated output trigger pulses can be configured within -0.5V and +2V.

NOTE

Enabling more than a single source for generating output trigger pulses is not allowed.

NOTE

Output triggers are generated each time an optical signal property / impairment pattern has finished. In continuous run mode, this means that there will be a trigger pulse indicating the start of the second and each subsequent playback of the pattern. There will be no output trigger indicating the start of the very first pattern playback that occurs after trigger configuration has been updated.

NOTE

Output triggers will be generated immediately once the selected optical signal property / impairment DSP stage completes playback of a pattern. Depending on the position of that specific DSP stage within the whole chain of stages and depending on whether subsequent stages are bypassed or operational, there will be a delay between the output trigger signal and the instant at which the symbol pattern data, corresponding to the pattern start, is actually present at the AWG output. See section [Trigger Timing](#) on page 34 for further details.

NOTE

Currently only phase noise and polarization control DSP stages can be configured for output trigger generation. Future versions of the 81195A software may enable additional DSP stages.

Impairment Trigger Input Configuration

Arming

Optical signal property / impairment DSP stages can be configured to start pattern playback upon input triggers. The respective DSP stage can be armed for Trigger In Connector, Waveform and for Software Triggers.

If neither input trigger is selected, the respective DSP stage will start pattern playback solely based on bypass / active / enabled settings in the respective GUI tabs.

If any trigger input source is selected for a specific DSP stage, optical signal property / impairment pattern playback will not start before an appropriate input trigger has occurred.

NOTE

For triggered operation, the respective optical signal property / impairment must not be bypassed or disabled in the respective GUI sections. While configuring the trigger setup, it can be helpful to disable input trigger arming for the respective stage and do a quick check of the AWG output signal to make sure that the intended pattern is actually being played. After that, the desired trigger arming can be set.

NOTE

Currently only phase noise and polarization control DSP stages can be configured for triggered operation. Future versions of the 81195A software may enable additional DSP stages.

NOTE

With retriggering disabled, pattern playback will start for the very first trigger signal, but ignore any subsequent trigger signals. The arming check boxes in the GUI will remain unchanged, though. To arm the system for another input trigger, the (unchanged) trigger settings need to be applied once again, using the respective GUI button. Clicking Send Data to Module(s)) will rearm the system as well.

Retriggering

The optical signal property / impairment patterns can be configured to run exactly once, after a trigger occurred, ignoring any triggers that may follow, or such that each trigger restarts the pattern. If retriggering is enabled, subsequent trigger pulses will cause the pattern playback to restart immediately.

Continuous and One-Shot operation

The optical signal property / impairment patterns can be configured to be played once per input trigger (one-shot) or to start continuous playback once triggered.

Trigger Timing

When working with input and output triggers, certain delays have to be considered. For illustration we assume a continuous, i.e., untriggered symbol pattern playback. In addition we assume continuous DSP pattern playback.

For a given DSP configuration (based on optical signal property / impairment and correction settings) with a single active DSP stage (all others set to bypass), there will be a certain delay between an input trigger and the instant at which the AWG output signal will correspond to the beginning of the DSP pattern playback (see level "A" on [Figure 5](#) on page 36). This base delay is caused by additional processing inside the instrument after the DSP. It will remain unchanged if an additional DSP stage in front of the one running the pattern is activated.

If, however, an additional DSP stage after the one running the pattern is activated (either in static configuration or in pattern playback mode), said delay will slightly increase since the data has to be processed by an additional DSP stage, before reaching the AWG output (see level "B" on [Figure 5](#) on page 36).

If more than one DSP stage is configured for pattern playback, all DSP stages will start playback simultaneously. Data processed by early DSP stages need to be processed by later DSP stages before reaching the AWG output. Therefore, the AWG output signal will show effects of later DSP sections first. After short additional delay(s), AWG output signals will show data being subject to the other DSP stage(s) as well (see level "C" on [Figure 5](#) on page 36).

NOTE

As described above, there will be a certain delay between the DSP pattern playback start trigger event and the AWG output showing signals affected by the pattern. With multiple DSP stages active, there will be a startup period, where not yet all of the patterns contribute to the output signal.

With output trigger generation active, an output trigger pulse will be generated each time the DSP pattern playback for the stage is complete. Since the data needs to be processed by that stage, there will always be a short delay between the output trigger pulse and the instant at which the output AWG data corresponds to the actual end of the pattern (see level "D" on [Figure 5](#) on page 36).

Activating further DSP stages after the one generating the trigger signal will cause this delay to increase (see level "E" on [Figure 5](#) on page 36).

Table 2 **Trigger-Out Properties**

Properties	Value/Range
Output impedance	50 Ohms (nom)
Voltage window)	-0.5V to 2.0V
Amplitude	200 m Vpp to 2.5 Vpp
Accuracy	+/- (10% + 25 mV) (typ)
Rise/fall times (20% to 80%)	<300 ps (typ)
Jitter	20 ps rms (typ)

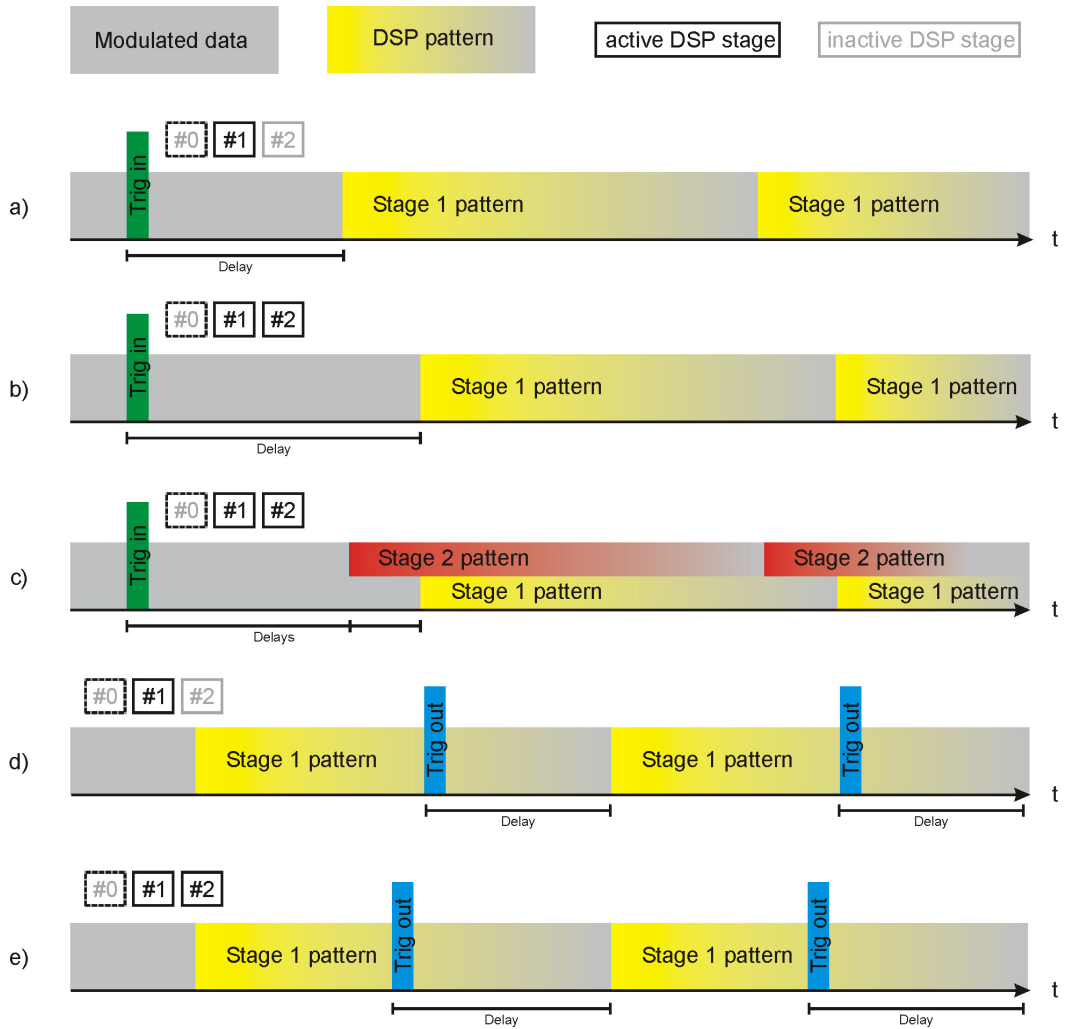

Figure 5 Illustration of trigger timing. Please note that delays are displayed exaggeratedly long. Usually they are much shorter than the pattern lengths.

Important Information regarding Waveform and Real-time Mode

Basic Restrictions

Quantization in Real-time Mode

In Real-time mode, all operations are performed in hardware, so the corresponding parameters and pattern entries are stored in registers of certain width in bits, which is less than the often used double-precision (32 bits) on PC hardware. Therefore all numbers transmitted to the DSP hardware are quantized accordingly.

Clock Cycles in Real-time Mode

The hardware architecture requires certain parameters to be multiples or remain constant over an integer number of clock cycles. The hardware processes 128 samples within one clock cycle.

This means that in Waveform mode, the waveform sample pattern length must be a multiple of 128, while in Real-time mode, the data symbol pattern length must be a multiple of 128.

When using polarization controller patterns, each n-tuple of polarization stage rotation/retardation angles is applied for one clock cycle, i.e., 128 samples / symbols. For instance, as a consequence the maximum change rate is limited to 500 MHz @ 64GS/s.

Similarly, when using IQ-rotator / phase noise patterns, each pattern element defines a rate of change of the signal phase, which is constantly applied over one clock cycle, i.e., 128 samples / symbols.

Coefficient Pattern Length

DSP blocks for Optical signal properties that support pattern mode operation for emulating dynamic effects have coefficient pattern memories of various lengths. (IQ-rotator/Phase noise = 1k coefficient sets, polarization controller = 10k coefficient sets)

Quantization and Clock cycles in Waveform Mode

When operating the 81195A Optical Modulation Generator in *Waveform* mode, mostly the same restrictions are applied, such that the optical signal property / impairment generation is as close as possible to the Real-time mode.

An exception to this is the correction FIR stage, which comprises a 16-tap FIR filter for each DSP channel in Real-time mode, while a filter with significantly more taps is used in waveform mode, to achieve optimum clean-signal performance.

Module Memory

The amount of addressable memory depends on several aspects.

When operating in *Waveform* mode, data must be stored in *Internal* memory mode. Doing so, 256 kSamples / channel can be used.

When operating in Real-time mode, data may be used in *Internal* memory mode as well (256 kSymbols / channel), but also in *Extended* memory mode. The amount of extended memory depends on the M8195A module. It comes with 2GB of memory in base configuration, which can be extended to 16GB by purchasing the “M8195A-16G” option.

In base configuration, 1GSymbol / channel is available, in 16G-configuration, 8GSymbols / channel is available.

Resampling

Resampling is not supported in Real-time mode.

Pulseshaper / PMD FIR number of filter taps

Due to the hardware architecture, the number of available / used FIR filter coefficients for the Pulseshaper stage and the PMD FIR filter stage vary. Usually this does not need to be specifically considered as it is handled internally. You will have to consider this behavior, though, when using a user-defined Pulseshaper file (see [Pulseshaper file](#) on page 280), together with specific PMD mode settings.

NOTE

The spacing between filter coefficients is always $1/(\text{Internal Sampling Frequency})$. Therefore, when changing the base symbol rate (full-/half-/quarter-rate), the coefficients need to be modified to reflect the new desired pulse width. The number of available coefficients may change, but that is only affecting the total duration of the filter, not the spacing of the coefficients.

The number of Pulseshaper filter coefficients depends on the *Base Rate* mode setting and the *PMD mode* setting like this:

Table 3 Pulse shaper FIR available number of filter coefficients for various PMD and Base Rate modes

Base Rate Mode	PMD Mode		
	bypass mode	7 segments mode	14 segments mode
Full Rate	32 coefficients	32 coefficients	not applicable
Half Rate	64 coefficients	64 coefficients	32 coefficients
Quarter Rate	64 coefficients	64 coefficients	64 coefficients

Direct Hardware Access in Real-time Mode

Whenever a valid hardware is detected and initialized, the module will be immediately configured with most settings. However when changing parameters some controls are updated automatically and other require completion by clicking “Send Data to Module”:

Table 4 Direct hardware access in Real-time mode

GUI Controls	Realtime Mode	Waveform Mode
Output Port settings (i.e. active toggle, amplitude, offset)	Automatically updated after change	Automatically updated after change
Data / Waveform Pattern (i.e. internal sample rate, modulation format, data pattern)	Only updated after clicking “Send Data to Module”	Only updated after clicking “Send Data to Module”
Other settings (e.g. phase noise, polarization, PMD, Pulseshaping, ...)	Automatically updated after change	Only updated after clicking “Send Data to Module”

In both Waveform and *Real-time* mode, this includes AWG output settings, such as *Output active* toggles, *Output amplitude* and *Output offset*.

In *Real-time* mode, almost all settings are automatically updated on the module upon changing. The only exceptions are trigger and clock rate related settings (such as the *Internal Sample Frequency*), modulation format and data pattern related settings (such as PRBS type, DC-balancing, etc.). Changing modulation format and data pattern related settings require *Send Data to Module(s)* to be clicked once again. For trigger and clock related settings it is sufficient to click the corresponding "Apply" button.

Please note that changing the modulation format in *Real-time mode* will immediately update the DSP encoder symbol table, so that you should see an appropriate constellation right away, but the symbol pattern will not represent the PRBS pattern that had been configured. You need to click *Send Data to Module(s)* to update the symbol pattern on the module to become a valid PRBS pattern.

In *Waveform* mode, basically all changes require *Send Data to Module(s)* to be clicked before the changes become effective.

Auto-Scale DSP Option

When operating in Real-time mode, numerical clipping within the FIR filter structures may occur. By default this is handled by the software automatically, finding appropriate settings to avoid clipping, while generating output values that make best use of the available (digital) dynamic range.

Please note that this clipping is not similar to any electrical over voltages at the instrument output. Usually it would just cause unexpectedly distorted constellations.

However, this automatism causes a slight delay. While, e.g., iteratively optimizing settings, such as skew values, it might be helpful to temporarily disable this setting from the Options menu until appropriate settings are found. Afterwards it should immediately be turned back on, to make sure that the clipping protection is in place.

Keysight 81195A Optical Modulation Generator
Software
User Guide

4 81195A User Interface

[Launching the 81195A Optical Modulation Generator Software](#) / 42

[Entering Data](#) / 46

[81195A User Interface Overview](#) / 48

Launching the 81195A Optical Modulation Generator Software

The 81195A OMG software is launched from the start menu. It is located in All Programs > Keysight 81195A Optical Modulation Generator Software.

Depending on the architecture of the operating system, there will be one (32bit) or two (32bit and 64bit) launchers for the 81195A OMG software present in the start menu folder.

NOTE

When available, it is recommended to use the 64bit version of the 81195A OMG software to make use of all available memory.

NOTE

On Windows 8 and Windows 10 only the 32bit 81195A launcher and Optical Modulation Generator software will be available.

NOTE

Only a single instance of the 81195A OMG Instance Manager may be started on a given PC.

The Instance Manager allows running up to five instances of the 81195A OMG software in parallel on a given PC. If an instance is launched with either 81195A-OSP or 81195A-RSP license, that license is unavailable for further instances until the initial instance is quit.

NOTE

Buying the respective option multiple times does not enable concurrent use of that licensed option on the same PC. This would require floating licenses (installed on a license server) instead, which is currently not supported.

By default the first instance of the 81195A OMG software will be started automatically with the Instance Manager, using all available licenses.

The 81195A OMG Instance Manager comprises a number of controls, which are described in detail in [Figure 6](#) on page 43.

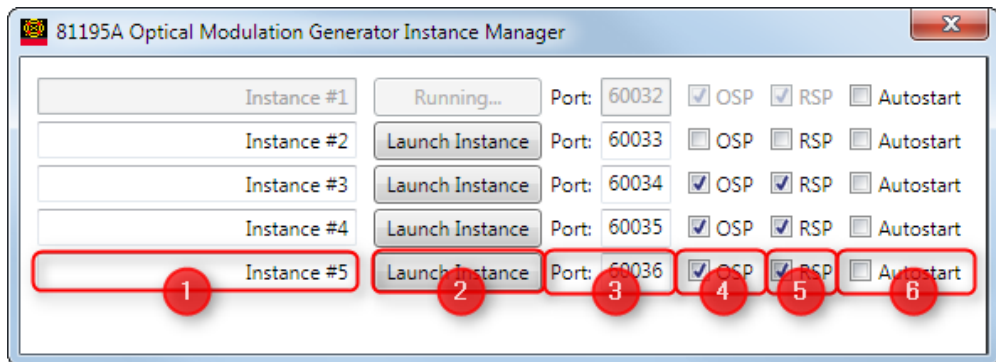

Figure 6 81195A Optical Modulation Generator Instance Manager

NOTE

Instance specific settings can be modified only if the respective instance is currently not running.

1 Instance Name

This control is used to change the name of the individual instances. Each instance stores its own settings and responds on specific ports, so changing the instance name is useful to identify running instances later on. The instance name will be shown in the window title bar of the instance and it will be returned as part of the *IDN? SCPI command.

2 Launch Instance

Use this button to manually start an 81195A OMG instance using its current settings. While one instance is being launched, the remaining launch buttons will be disabled.

3 Socket Port

This control defines the port number that is used for automation using the TCP/IP Socket interface.

4 OSP

Use this check box to make the specific instance use the 81195A-OSP license (if available). This way, an instance with reduced feature set may be launched, to keep license(s) available for instances that are yet to be launched.

5 RSP

Use this check box to make the specific instance use the 81195A-RSP license (if available). This way, an instance with reduced feature set may be launched, to keep license(s) available for instances that are yet to be launched.

6 Autostart

Use this check box to define whether the respective 81195A OMG instance is to be started immediately, whenever the Instance Manager is started. Only a single instance may be selected for automatic start.

NOTE

Depending upon the hardware of the PC that is running the 81195A OMG software, launching an 81195A OMG instance may take some time. Progress will be indicated in the launcher window. Please be patient.

NOTE

Each instance of the 81195A OMG software stores its own configuration and settings, such as instrument Visa addresses, modulation and data format or optical signal property configuration. Instances are identified by their position in the Instance Manager list, not by their user-defined names. If the same instance is (subsequently) launched, it will be using the same settings as the previous session. 32bit and 64bit versions share their settings.

NOTE

Closing the 81195A OMG Instance Manager will also cause all open 81195A OMG software instances to close as well.

NOTE

After closing an 81195A OMG software instance, some internal clean-up operations take place. Therefore, it will take a short while until the instance and respective licensed options become available again in the OMG Instance Manager.

NOTE

Since the 81195A OMG software is using the M8194/5/6/7A Firmware and Soft Front Panel to communicate with the AWG module(s), said Soft Front Panel (SFP) is minimized to the system tray to avoid any unexpected and undesired changes done through the SFP graphical user interface. In case there is a certain SFP setting that is explicitly required and not accessible through the 81195A OMG software, see section [Options](#) on page 51 for details on how to get the SFP back from the system tray.

NOTE

The 81195A OMG graphical user interface will automatically rescale its window size and some font sizes to better fit on lower screen resolutions. While the window size can be changed by moving the mouse cursor on top of the window frame borders, then use the common window resizing mechanisms, this won't affect the font sizes. See section [Options](#) on page 51 for details on how to specifically activate window and font size settings related to a specific screen resolution.

Entering Data

Throughout the 81195A graphical user interface, there are many numeric input controls. Since there are multiple ways to modify the data in those controls, they are described here.

Units

Most numeric settings have a certain unit assigned to them. These units are added automatically by the 81195A software when numeric values are displayed and should not be entered when typing into the edit control.

Metric Prefixes

The 81195A software will automatically show numbers in a compact visualization by using metric prefixes, such as ps for picoseconds.

Metric prefixes can be typed just as with the numbers themselves. Once a non-numeric character is typed that is recognized as a metric prefix (case-insensitive), the 81195A software assumes the numeric input for that control being complete and interprets the number accordingly, displaying it with metric prefix and unit. This will also trigger any graph or real-time hardware update, where appropriate, as leaving a changed control by clicking the tab or entering key would.

To resolve the ambiguity between milli and Mega, controls are categorized internally, whether to contain large or small number, so for frequencies only MHz will be considered, while for AWG amplitudes only mV will be considered.

NOTE

If a control displayed a value with a certain metric prefix and a new value is entered without a metric prefix, the previous prefix will be kept. This reduces the number of required keys to press, when changing values that usually don't need to be changed by large amounts.

NOTE

In consequence, entering numbers in engineering/scientific notation (e.g., $5e-12$) or decimal notation (e.g. 0.003) without a metric prefix, will cause the previous prefix to be kept and just added to the number, which may lead to unexpected results.

NOTE

The 81195A software always chooses the metric prefix suited for compact display based on the currently set value. When the current value is set to zero, the metric prefix is omitted. Thus, for a value subsequently entered in this control, no metric prefix will be applied.

Limits

If a value is entered that exceeds the upper or lower limit for a certain control, the value will be clipped to that limit value instead and a corresponding warning will be shown in the status bar (see section [Status / Warning / Error Bar](#) on page 75).

Cursor Keys and Mouse-Wheel

Most of the numeric controls have predefined step sizes, so that the up and down cursor keys can be used to vary the value by this step size. Similarly, hovering the mouse cursor over a numeric control, then moving the mouse-wheel up and down will change the value by that step size.

Holding down the CTRL key while pressing the cursor up or down key will change the value by a tenth of the default step size for that control.

Holding down the ALT key while pressing the cursor up or down key will change the value by ten times the default step size for that control.

Sliders and Numeric Controls

Some settings can be controlled through a numeric control as well as through a slider. If either of these is changed, the other will be updated accordingly, automatically.

81195A User Interface Overview

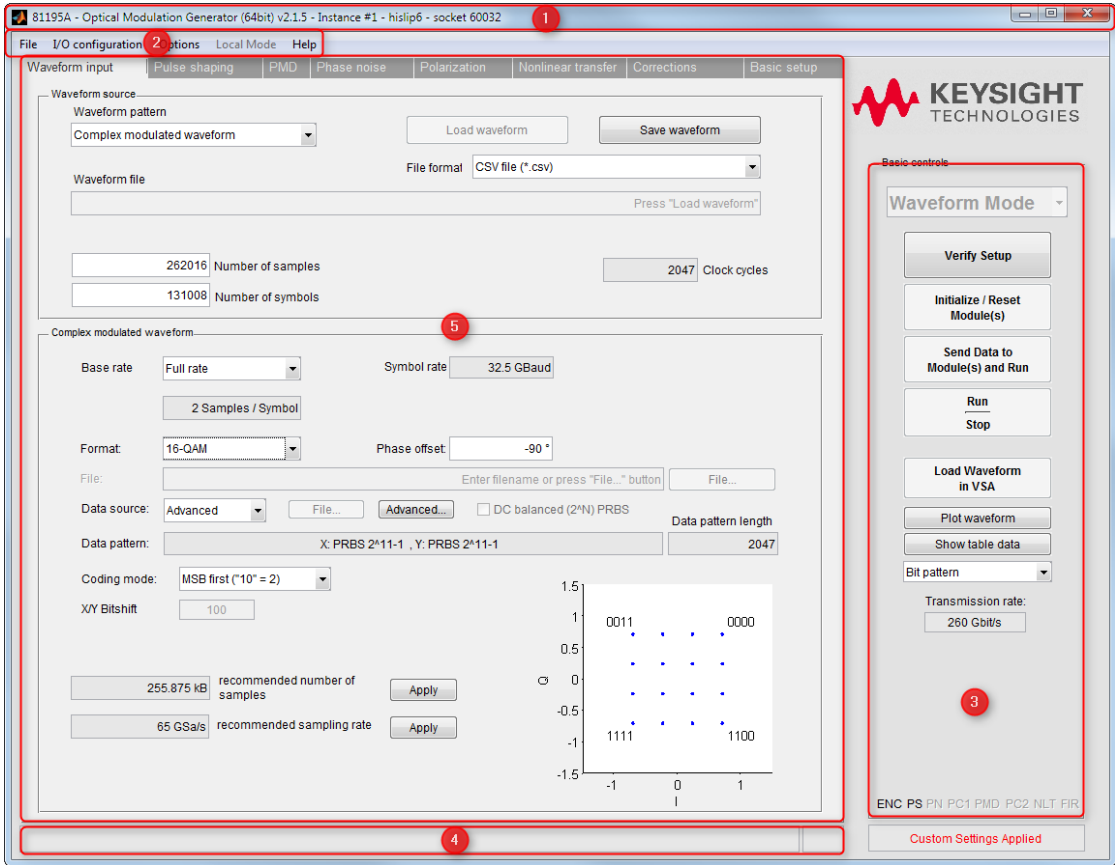

Figure 7 81195A User Interface

Title Bar

The title bar contains the standard Microsoft Windows elements such as the window title and the icons for minimizing, maximizing, or closing the window.

Furthermore it indicates whether this instance of the 81195A OMG software is running in 32bit or 64bit mode (1), its revision number (2), its user-defined instance name (3), its auto-generated HiSLIP address (4) and its user-defined socket port number (5) (see figure [Figure 8](#) on page 49)

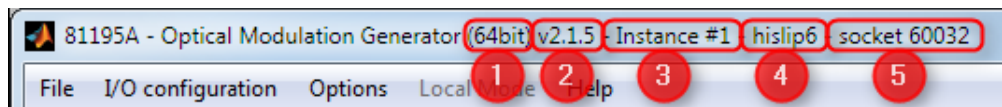

Figure 8 81195A Optical Modulation Generator title bar

Menu Bar

The menu bar consists of various pull down menus that provide access to the different functions and launch interactive GUI tools.

The menu bar includes the following pull down menu:

- File
- I/O configuration
- Options
- Local Mode
- Help

Each menu and its options are described in the following sections.

File

The File menu includes the following selections:

- **File – Load Settings...**

Opens a file selection dialog for loading previously saved settings from a file. The file extension is automatically set to show only complete settings files, but other extensions can be selected as well. If the file was saved using *File – Save Settings*, this operation may take a few seconds to complete.

- **File – Save Settings...**

Opens a file dialog for saving a complete set of settings, including hardware VISA addresses, clock setup and all signal generation / optical signal properties / impairments settings (all tabs).
- **File – Revert to Default Settings**

Reverts all settings to their default state. This operation may take a few seconds to complete.
- **File – Load Waveform / Pattern Settings**

Opens a file selection dialog for loading previously saved settings from a file. The file extension is automatically set to show only waveform / pattern settings files, but other extensions can be selected as well. If the chosen file was saved using *File – Save Settings*, this operation may take a few seconds to complete.
- **File – Save Waveform / Pattern Settings**

Opens a file dialog for saving the current waveform / pattern related settings (Waveform Input tab) to a file.
- **File – Load PMD Settings**

Opens a file selection dialog for loading previously saved settings from a file. The file extension is automatically set to show only PMD settings files, but other extensions can be selected as well. If the chosen file was saved using *File – Save Settings*, this operation may take a few seconds to complete.
- **File – Save PMD Settings**

Opens a file dialog for saving the current PMD settings (PMD tab) to a file.
- **File – Load Phase Noise Settings**

Opens a file selection dialog for loading previously saved settings from a file. The file extension is automatically set to show only Phase Noise settings files, but other extensions can be selected as well. If the chosen file was saved using *File – Save Settings*, this operation may take a few seconds to complete.
- **File – Save Phase Noise Settings**

Opens a file dialog for saving the current Phase Noise settings (Phase Noise tab) to a file.
- **File – Load Polarization Settings**

Opens a file selection dialog for loading previously saved settings from a file. The file extension is automatically set to show only Polarization settings files, but other extensions can be selected as well. If the chosen file was saved using *File – Save Settings*, this operation may take a few seconds to complete.

- **File – Save Polarization Settings**

Opens a file dialog for saving the current Polarization settings (Polarization tab) to a file.

- **File – Exit**

Exits the 81195A Optical Modulation Generator Software.

I/O configuration

The I/O Config menu contains the following sections:

- **I/O Configuration – Instrument VISA setup**

Opens a dialog for configuring VISA addresses of connected instruments and of the VISA software (see section [Instrument VISA setup](#) on page 55 for details).

- **I/O Configuration – Clock Setup**

Opens a new dialog for configuring sampling rate and reference clock settings (see section [Clock Setup](#) on page 61 for details).

- **I/O Configuration – Trigger Setup**

Opens a new dialog for configuring the input/output trigger settings (see section [Trigger Setup](#) on page 64 for details).

Options

The Options menu includes the following items:

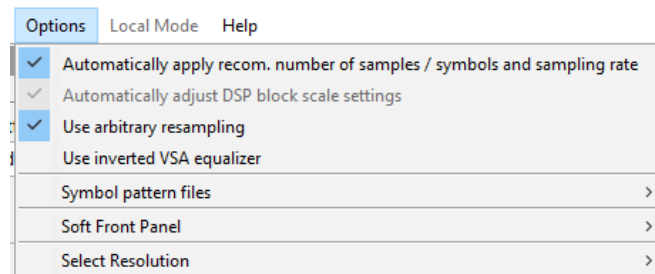

Figure 9 Options menu

- Automatically apply recommended number of samples / symbols and sampling rate.

Toggle this option to activate/deactivate the automatic appliance of the recommended number of samples and sampling rate after the change of signal parameters.

- Automatically adjust DSP block scale settings (only in real-time mode)
This menu item activates/deactivates the automatic DSP scaling mode. See section [Auto-Scale DSP Option](#) on page 40 for further details.
- Use arbitrary resampling (only in waveform mode)
Toggle this option to activate/deactivate the usage of arbitrary resampling, while calculating a waveform with *Resampling* selected. When arbitrary resampling is active (default in waveform mode), it offers more flexibility for generating waveforms with non-rational baud rates or data patterns with an uneven number of bits (such as the standard 2^N-1 PRBS). The generated waveforms will generally be shorter compared to those using fractional resampling, resulting in less memory demand and faster upload times.

NOTE

Arbitrary resampling is available only in waveform mode. In real-time mode choose from one of the natively supported symbol rates, i.e. full rate, half rate or quarter rate (for more details see [Base Rate](#) on page -84).

NOTE

From software Rev.2.2, the usage of arbitrary resampling is the default setting in waveform mode and allows to enter the desired signal baud rate in the corresponding field *Resampling symbol rate* (for more details see [Resampling Symbol Rate / Symbol Rate](#) on page -84). To use the natively supported symbol rates (such as full rate, half rate or quarter rate), deactivate arbitrary resampling in the Options menu.

- Use inverted VSA equalizer
If reading out and applying the VSA equalizer as correction filter does not improve the signal quality, but makes it worse instead, the equalizer frequency response might be applied with inverted characteristic. This has been observed in older VSA version when switching between “Digital Demod” and “Custom IQ” measurement types. In this case, enable the *Use inverter VSA equalizer* setting in the Options menu.
- Symbol pattern files
This menu item contains two submenus which control the behavior of generated symbol pattern files
 - *Keep all symbol pattern files*

If active (default) all calculated symbol patterns will be kept for later use. This way, symbol / sample pattern generation performance is speeded up at the cost of disk space.

NOTE

All changes to symbol/PRBS-related parameters as well as some other parameters (e.g. the Modulation Format) will cause a unique file to be created.

- *Browse symbol pattern folder*

Opens the symbol pattern directory in Windows Explorer.

NOTE

Use this to delete obsolete files and free up disk space.

- Soft front panel

Whenever the *Initialize/Reset Module(s)* button is clicked, the M8194/5/6/7A Soft Front Panel instance of the configured AWG module is minimized to the system tray with no further access. This way, unexpected changes in the instrument configuration are avoided while the 81195A software is actively controlling the instrument.

This menu contains controls to explicitly show or hide the M8194/5/6/7A Soft Front Panel.

- Set SFP visible

This menu item maximizes the M8194/5/6/7A Soft Front Panel.

NOTE

It is not recommended to work with a maximized / visible Soft Front Panel, when using the 81195A OMG software. In rare cases, the user might want to access a certain AWG setting that is not available through the 81195A user interface. If so, the Soft Front Panel can be shown this way and the setting applied. The M8194/5/6/7A Soft Front Panel should be minimized after applying the change, though.

- Set SFP invisible

This menu item minimizes the Soft Front Panel to the system tray.

- Select resolution

By default the 81195A software checks the screen resolution upon start and selects the window size which fits best. However if you encounter problems in reading the menus you can manually switch to a different size by selecting one of the below listed resolutions:

Available resolutions (given by number horizontal pixels):

- 1024
- 1280
- 1440
- 1680
- Auto

Choosing *Auto* resolution will perform the same analysis that happens automatically, when starting the 81195A OMG software and that chooses the appropriate size settings to match the computer screen.

NOTE

The 81195A OMG software graphical user interface can be resized manually as well, but that way all font sizes remain the same. When using one of the resolution settings above, though, smaller font sizes are applied for lower resolutions.

Local Mode

Whenever the 81195A Optical Modulation Generator software is remote controlled, the GUI will be set to disabled state, to avoid unintended interruption due to local GUI activity. Click the Local Mode menu item to take back control over the GUI.

Help

The Help menu includes the following items:

- Optical Modulation Generator User's Guide
Opens this document if there is a viewer program configured for pdf files.
- Online Update Check
Starts a check for available updates in the background. Requires an Internet connection.

- Launch Package Manager
Opens the Package Manager (see section [Launching the 81195A Optical Modulation Generator Software](#) on page 42 for details).
- About...
Shows information about the 81195A software, third-party software and installed 81195A licenses.
- SCPI Overlay Show / Hide
Selecting Show will replace all currently visible GUI controls of the main GUI and any open dialog (e.g. clock setup) by their corresponding SCPI commands. In case of drop-down menus, all available selections are shown as well.

NOTE

When switching to a different tab or opening a dialog, no SCPI overlay will be shown unless selected again from this menu.

NOTE

Only one tab at a time can be set to SCPI overlay mode.

NOTE

SCPI overlay needs to be actively turned off to revert the GUI to regular operation.

Instrument VISA setup

This dialog is used to configure VISA addresses of connected instruments / software tools.

This dialog contains disabled controls for configuring a real-time scope as well. These controls will be used in future versions of the 81195A OMG software.

The dialog is shown in the following figure and its controls are described below.

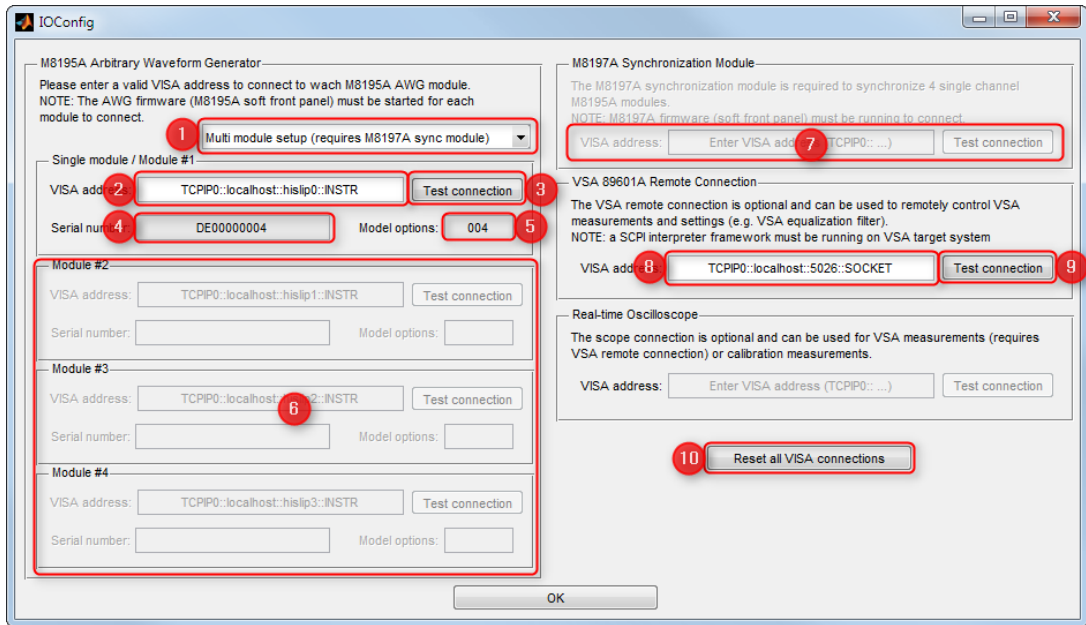

Figure 10 Instrument VISA Setup dialog

1 Single/Multi Module Setup Selector

This control is used to select whether to configure a single AWG module or a multi-module setup, which requires an additional M8197A Synchronization Module.

NOTE

Multi-module setups are not supported for M8194/6A instruments.

2 AWG module VISA address

This control is used to set the VISA address for the AWG mainframe. Once set, the *Test AWG VISA Connection* button can be used to make sure the connection is OK and the instrument is communicating correctly.

The default value is a HiSLIP connection (hislip0) to “localhost”, which is automatically available if M8194/5/6/7A Firmware and Soft Front Panel and the 81195A OMG software run on the same PC.

NOTE

The 81195A OMG software is not connecting to the actual AWG module’s mainframe through USB or PCIe, but always to an instance of the M8194/5/6/7A Firmware and Soft Front Panel instead, which in turn is connected to the module’s mainframe. Therefore the connection type will always be some kind of LAN interface.

NOTE

The complete VISA address of the AWG module can be copied from the M8194/5/6/7A Firmware and Soft Front Panel about box. This assumes that the SFP has already been connected to the specific AWG module. Please note that VISA addresses copied this way will always contain “localhost” as hostname. If you’re accessing the M8194/5/6/7A Firmware and Soft Front Panel from a different PC, you have to use the corresponding hostname or IP address instead.

NOTE

The M8194/5/6/7A Firmware and Soft Front Panel and the 81195A OMG software may run on the same PC, but don’t have to do so. If they do, you may use the hostname “localhost” when entering the VISA address.

NOTE

When using LAN connections for VISA communication, it is usually required that the instrument has been added to the Keysight Connection Expert before (see section [IO Libraries Suite](#) on page 17 for details).

NOTE

Changing the VISA address will invalidate any former setup verification and require the *Verify Setup* button to be clicked again before continuing work with the 81195A OMG software.

3 Test AWG VISA connection

Once the *AWG module VISA address* has been set, instrument communication can be checked using this button. It is not strictly required to do so, since the *Verify Setup* button (see section [Verify](#)

Setup on page 70) will perform a similar test. Either way it can be convenient to get an immediate feedback right after adding the VISA address.

4 Serial number

Once the Test connection button has been clicked and the instrument has been successfully identified, its serial number is shown here.

5 Model options

Once the Test connection button has been clicked and the instrument has been successfully identified, its model options are shown here.

6 Module #2, Module #3, Module #4

If a multi-module setup is selected (see **Single/Multi Module Setup Selector** on page 56), the individual module VISA address controls, their Test connection buttons and their Serial number and Module options displays become accessible. Refer to the respective controls of Module #1 for details on the individual controls.

NOTE

The M8197A Synchronization Module is always to be placed in the lowest mainframe slot (slot 1). When using two M8195A modules, they need to be placed in slots 2 and 3 and should be configured as Module #1 and Module #2 respectively. When using four modules, Module #3 goes in slot 4 and Module #4 goes in slot 5.

7 M8197A Synchronization Module VISA address

If a multi-module setup is selected (see **Single/Multi Module Setup Selector** on page 56), the VISA address controls and the Test connection buttons for the M8197A Synchronization Module become accessible. Refer to the respective controls of Module #1 for details on the individual controls.

8 VSA 89601B VISA address

This control is used to set the Visa address for the VSA software. Once set, the *Test VSA Visa Connection* button can be used to make sure the connection is ok and the software is communicating correctly.

The default value is a socket connection (port 5026) to “localhost”, assuming the VSA software has been started on the same PC and its SCPI server running and configured accordingly. See section **Instrument VISA setup** on page 55 for details on configuring the 89601B VSA SCPI server.

NOTE

The recommended VISA interface for addressing the VSA software is Socket.

NOTE

When using LAN connections for VISA communication, it is usually required that the instrument has been added to the Keysight Connection Expert before (see section [Launching the 81195A Optical Modulation Generator Software](#) on page 42 for details).

NOTE

Changing the VISA address will invalidate any former setup verification and require the *Verify Setup* button to be clicked again before continuing work with the 81195A OMG software.

9 Test VSA connection

Once the *VSA 89601B VISA address* has been set, communication can be checked using this button. It is not strictly required to do so, since the *Verify Setup* button (see section [Instrument VISA setup](#) on page 55) will perform a similar test. Either way it can be convenient to get an immediate feedback right after adding the VISA address.

10 Reset all VISA connections

Under certain circumstances, instrument communication may fail, e.g., if an instrument was in use already by another application, using exclusive access.

Sometimes it can be helpful to explicitly reset all communication channels between the 81195A OMG software and the instruments.

NOTE

Usually a manual reset of the VISA connections is unnecessary. If an operation, such as *Verify Setup* or *Send Data to Module(s)* fails due to a communication issue, an instrument connection reset is triggered automatically. Just retrying the same operation should succeed then.

NOTE

Should the 81196A OMG software become unable to communicate with the 89601B VSA, a SCPI server restart may be required. This can be done by double-clicking the red Keysight Translator Framework icon in the system tray, then clicking the Stop button (1), followed by the Start button (2) in the Keysight Translator Framework user interface, as shown in the Figure 11 on page 60.

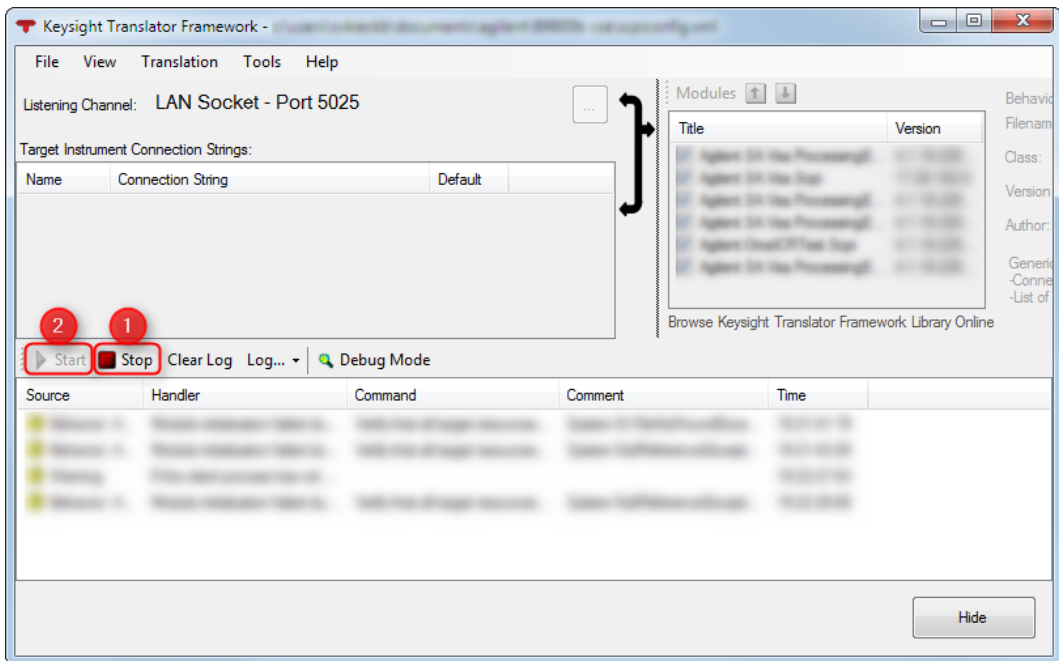

Figure 11 Keysight Translator Framework

Clock Setup

This menu item opens the following dialog which is used to configure sample frequency and clock related settings and controls which are explained in detail below:

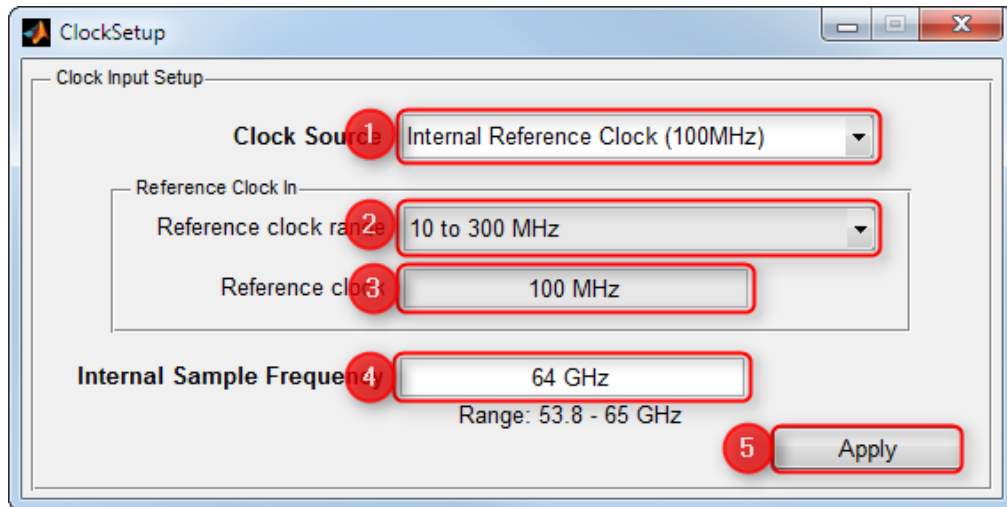

Figure 12 Clock Setup dialog

1 Clock Source

This control defines the reference clock source. It is set to Internal Reference Clock (100MHz) by default, but it can be used to choose a provided external reference clocks or the mainframe backplane reference clock as well. Setting this to *Reference Clock In* enables controls *Reference Clock Range* and *Reference Clock*. For more details see *M8195A / M8196A User Guide*.

Available Settings:

- AXIe Backplane (100MHz)
- Reference Clock In
- Internal Reference Clock (100MHz)

NOTE

Due to the inherent clock characteristics of M8194A, **Internal Reference Clock (100MHz)** is the only viable option for Clock Source when you have connected to an M8194A AWG.

NOTE

Click the Apply button to update this setting on the instrument(s).

2 Reference Clock Range

When Clock Source is set to *Reference Clock In*, this control is used to define the coarse range of the provided reference clock frequency. *Reference Clock* is required to lie within the selected range.

Available Settings:

- 10-300MHz
- 210MHz-17GHz (M8195A)
- 162MHz - 17GHz (M8196A)
- 2.32-3GHz (M8196A only)

NOTE

Click the Apply button to update this setting on the instrument(s).

3 Reference Clock

This control defines the actual frequency of the externally provided reference clock. *Reference Clock Range* needs to be set to the appropriate range before setting this value.

Allowed Range: as defined by *Reference Clock Range* control.

NOTE

Click the Apply button to update this setting on the instrument(s).

4 Internal Sampling Frequency

This control defines the sampling frequency or clock rate of the digital/analog conversion of the AWG. By default, the software will generate signals with two samples per symbol, so the *Symbol Rate* will be half as high as the *Internal Sampling Frequency*.

NOTE

Changes to the Internal Sampling Frequency are applied to the instrument(s) by clicking the Apply button or the next time the Send Data to Module(s) button is clicked.

NOTE

If *Base Rate* is set to *Half Rate* / *Quarter Rate*, there will be four / eight samples per symbol, so that with an unchanged *Internal Sampling Frequency* the resulting *Symbol Rate* will be reduced to one half / one quarter.

NOTE

If *Options – Automatically apply recommended number of samples / symbols and sampling rate* is checked and you are choosing a certain *Symbol Rate* with *Base Rate* set to *Resampling*, this value will automatically be set to the most appropriate value for generating the desired *Symbol Rate*.

5 Apply

Clicking this button applies the clock input settings.

Trigger Setup

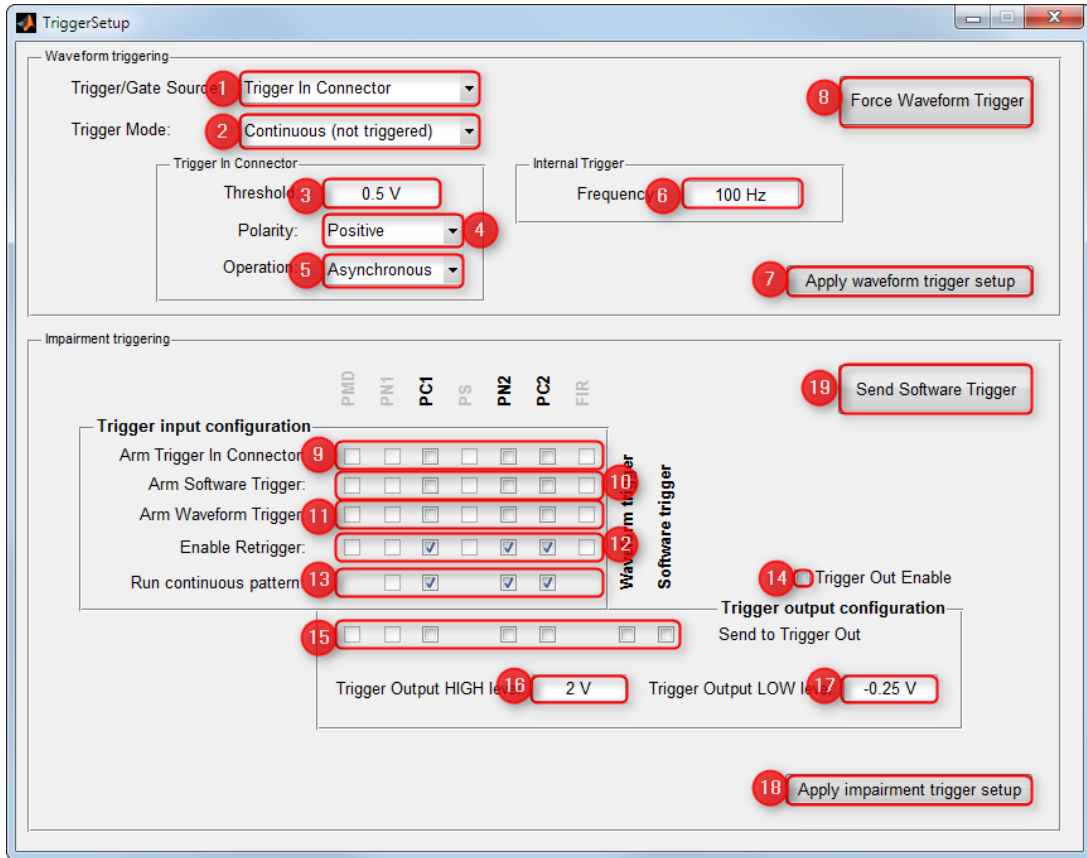

Figure 13 Trigger Setup dialog

NOTE

Triggered operation is not supported for M8194/6A instruments.

NOTE

Optical signal property / impairment triggering is only available in real-time mode and thus requires the 8119A-RSP option.

NOTE

Currently only phase noise and polarization control DSP stages can be configured for triggered operation or output trigger generation. Future versions of the 81195A software may enable additional DSP stages.

NOTE

For details on trigger behavior see section [Input and Output Triggers](#) on page 29.

NOTE

Changes to the waveform or impairment trigger configuration are not applied immediately. They are automatically applied the next time Send Data to Module(s) is executed. To apply changed settings to the instrument(s) without sending the symbol data again, the corresponding Apply button can be used.

This menu opens the following dialog which is used to configure input/output trigger settings and which controls are explained in detail in the section, that follows.

1 Trigger/Gate Source

This drop down menu defines the source for Waveform trigger generation. It can be either the M8195A front connector labeled “TRIG IN” or a periodically generated internal trigger signal of adjustable repetition rate (see Frequency control). Changing this value will take effect after clicking Apply waveform trigger setup or Send Data to Module(s) and Run.

Available Settings:

- Trigger In Connector
- Internal Trigger

2 Trigger Mode

This drop-down menu defines the input trigger behavior of the waveform / symbol pattern playback. If set to Continuous (not triggered), playback will run continuously once uploaded using Send Data to Module(s) and Run or once started using the Run/Stop button. If set to triggered, playback will not start until an appropriate input trigger has been detected. Changing this value will take effect after clicking Apply waveform trigger setup or Send Data to Module(s) and Run.

Available Settings:

- Continuous (not triggered)
- Triggered

NOTE

When using extended memory and activating Triggered mode, the waveform will be played once per trigger. When using internal memory instead, continuous playback will start, even on a single trigger pulse.

NOTE

The Trigger Mode setting does not affect triggering of the optical property / impairment DSP sections. When set to Continuous (not triggered), waveform / symbol pattern playback automatically starts after clicking Send Data to Module(s) and Run and can be stopped and resumed using the Run/Stop button. Depending on the arm configuration in the impairment trigger section, input triggers may start playback of signal property / impairment patterns anyway, even though they are ignored regarding waveform / symbol pattern playback.

3 Threshold

This control specifies the threshold voltage for an input trigger. Changing this value will take effect after clicking Apply waveform trigger setup or Send Data to Module(s) and Run.

Allowed Range: -4...4V

4 Polarity

This drop down menu defines the polarity or slope of the input signal that is considered as a trigger pulse. Changing this value will take effect after clicking Apply waveform trigger setup Send Data to Module(s) and Run.

Available Settings:

- Positive
- Negative
- Either

5 Operation

This drop down menu defines the trigger operation mode. See *M8195A User's Guide* for further details. Changing this value will take effect after clicking Apply waveform trigger setup Send Data to Module(s) and Run.

Available Settings:

- Asynchronous
- Synchronous

6 Internal Trigger Frequency

This control defines the repetition rate at which internal triggers will be generated if Trigger Source is set to Internal Trigger. Changing this value will take effect after clicking Apply waveform trigger setup or Send Data to Module(s) and Run.

Allowed Range: 0.1 Hz...17.85 MHz

7 Apply waveform trigger setup

This button is used to apply changed waveform trigger settings to the instrument(s) for the currently playing waveform or symbol pattern.

8 Force waveform trigger

This button allows manual generation of a waveform trigger inside the instrument(s).

9 Arm Trigger Input Connector trigger

These check boxes define whether a trigger pulse at the TRIG IN front panel connector will start the respective signal property / impairment stage. Changing this value will take effect after clicking Apply impairment trigger setup or Send Data to Module(s) and Run.

NOTE

For triggered operation the respective signal property / impairment stage(s) must not be set to bypass (see respective GUI tabs).

10 Arm waveform trigger

These check boxes define whether a waveform trigger (see section [Trigger Setup](#) on page 64) will start the respective signal property / impairment stage. Changing this value will take effect after clicking Apply impairment trigger setup or Send Data to Module(s) and Run.

NOTE

For triggered operation the respective signal property / impairment stage(s) must not be set to bypass (see respective GUI tabs).

11 Arm software trigger

These check boxes define whether a software trigger (see section [Trigger Setup](#) on page 64) will start the respective signal property / impairment stage. Changing this value will take effect after clicking Apply impairment trigger setup or Send Data to Module(s) and Run.

NOTE

For triggered operation the respective signal property / impairment stage(s) must not be set to bypass (see respective GUI tabs).

12 Enable retrigger

These check boxes define whether the respective signal property / impairment DSP stages react only to the first trigger pulse or whether they are triggered by every subsequent trigger pulse as well. Changing this value will take effect after clicking Apply impairment trigger setup or Send Data to Module(s) and Run.

13 Run continuous pattern

These check boxes define whether the respective signal property / impairment DSP stages will run their pattern exactly once after receiving a trigger pulse or if each trigger pulse starts continuous replay of the respective stage's pattern. Changing this value will take effect after clicking Apply impairment trigger setup or Send Data to Module(s) and Run.

NOTE

When arming a certain DSP stage for triggering with Enable retrigger and Run continuous pattern turned off (one-shot operation), clicking Apply impairment trigger setup (or clicking Send Data to Module(s)) will rearmed that stage for another one-shot.

14 Trigger Out Enable

This control is used to enable or disable trigger output. If enabled, trigger signals will be sent to the front panel connector labeled EVENT IN. Changing this value will take effect after clicking Apply impairment trigger setup or Send Data to Module(s) and Run.

15 Trigger Out

These check boxes define whether the respective signal property / impairment DSP stages will generate an output trigger pulse on the front panel connector labeled EVENT IN. Changing this value will take effect after clicking Apply impairment trigger setup or Send Data to Module(s) and Run.

NOTE

Only a single DSP stage may be selected for generating output trigger pulses.

NOTE

Trigger pulses will be generated each time that the respective DSP stage's pattern has finished playback. See section [Input and Output Triggers](#) on page 29 for a more detailed description of output trigger behavior.

16 Trigger out HIGH level

This control defines the upper level of the generated output trigger signals. Changing this value will take effect after clicking Apply impairment trigger setup or Send Data to Module(s) and Run.

Allowed Range: -0.5...2V

17 Trigger out LOW level

This control defines the lower level of the generated output trigger signals. Changing this value will take effect after clicking Apply impairment trigger setup or Send Data to Module(s) and Run.

Allowed Range: -0.5...2V

18 Apply impairment trigger setup

This button is used to apply changed impairment trigger settings to the instrument(s) for the currently playing waveform or symbol pattern.

19 Send Software Trigger

This button sends a software trigger to the instruments.

Basic Controls Bar

The basic control bar contains a number of controls used for basic instrument control and related functions. Figure 14 on page 70 shows these controls, which are explained in detail below.

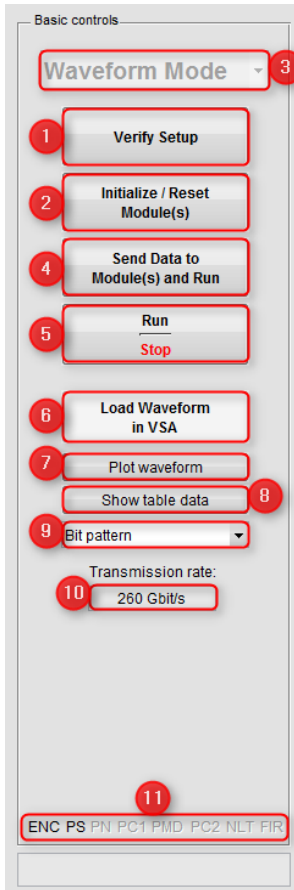

Figure 14 Basic Controls bar

1 Verify Setup

This button is used to check whether all required instruments and (optionally) the VSA software are available.

This step is required to enable the *Initialize / Reset Module(s) and Load Waveform in VISA* buttons below.

The former will be enabled if the AWG module configured in the *Instrument VISA setup* dialog (see section [Instrument VISA setup](#) on page 55) is available.

The latter will be enabled if VISA is configured in the *Instrument VISA setup* dialog (see section [Instrument VISA setup](#) on page 55) is available.

NOTE

Changing VISA addresses in the *Instrument VISA setup* dialog or changing the *Module Configuration on the Basic Setup* tab will invalidate any former setup verification and require this button to be clicked again.

2 Initialize / Reset Module(s)

This button is used to initialize communication with AWG modules.

Certain basic parameters of the module will be set or reset in this step.

This step is required to enable the *Send Data to Module(s)* button below.

NOTE

Changing VISA addresses in the *Instrument VISA setup* dialog or changing the *Module Configuration* on the *Basic Setup* tab will invalidate any former setup verification and require the *Verify Setup* button to be clicked again.

3 Waveform / Real-time Mode Selector

This control is used to toggle between Waveform and Real-time operation.

NOTE

This control becomes enabled only after *Initialize/Reset Module(s)* has been clicked and the connected module has been successfully initialized.

NOTE

Using Real-time mode requires the 81195A-RSP option, so this control will be disabled without a valid 81195A-RSP license being installed.

NOTE

Changing VISA addresses in the *Instrument VISA* setup dialog or changing the *Module Configuration* on the *Basic Setup* tab will invalidate any former setup verification and require the *Verify Setup* button to be clicked again.

4 Send Data to Module(s)

This button is used to send a waveform / symbol pattern data to the AWG module.

When operating in *Waveform* mode, the waveform needs to be actively sent to the AWG module by clicking this button to reflect any changes applied in the user interface.

When operating in *Real-time* mode, the symbol pattern needs to be sent to the AWG module by clicking this button to reflect any changes applied in the *Waveform Input* tab or the *Clock Settings* dialog, namely to

- any symbol pattern setting (e.g. PRBS settings)
- the modulation format (e.g. QPSK)
- the sampling rate

All other settings (optical signal properties / impairments) are set in the module's DSP immediately after being changed in the user interface.

NOTE

Changing the modulation format will immediately reconfigure the DSP's encoder to generate the new symbols, but the data pattern will no longer reflect the previously configured settings until *Send Data to Module(s)* is clicked once again.

5 Run / Stop

This button is used to stop and restart waveform generation / playback on the AWG instrument(s). The current playback state is indicated on the button.

6 Load Waveform in VSA

This button is used to send a waveform pattern to the 89601B VSA software.

NOTE

This button will be enabled if a valid VISA address for the 89601B VSA software is configured in the *Instrument VISA Setup* dialog (see section *Instrument VISA setup* on page 55), the AWG model is set to 89600 VSA on the *Basic Setup* tab (*Basic Setup* on page 158) and the *Verify Setup* button has been clicked.

7 Plot Waveform

This button is used to open a number of additional figures, namely

- Waveform data over time for each channel
- Spectrum plots for X and Y channel
- Constellation plots for X and Y channel

The plot waveform operation will be unavailable when in real-time mode at half or quarter base rate.

NOTE

All settings from the *Corrections* and the *Basic Setup* tab will be ignored when plotting waveforms. Those settings are only active when sending data to an actual AWG module.

8 Show Table Data

This button is used to show numerical data in an additional table window.

The *Table Data Selector* control is used to choose what data is to be visualized this way.

NOTE

Once the table data window was opened by clicking this button, it will stay open until closed. It will be updated only automatically when a new waveform is computed, i.e., whenever a waveform is plotted, loaded in VSA, saved to a file or send to an AWG module.

9 Table Data Selector

This control is used to select the data to be visualized by the *Show Table Data* button.

Available Settings:

- Bit Pattern

This is the actual PRBS sequence used as data input for the X and Y symbol pattern.

- Symbol Pattern

This is the symbol sequence generated for X and Y polarization.

- Waveform Symbols

This is a list of the constellation points corresponding to the symbol sequence.

- Waveform Samples

This is a list of the resulting waveform samples, taking into account pulse shaping and optical signal property / impairment settings. Settings from the *Corrections* and the *Basic Setup* tab are ignored. Those settings are only active when sending data to an actual AWG module.

10 Transmission Rate

This indicator shows the resulting transmission rate, based on sampling rate, symbol rate and modulation format settings.

11 DSP / Optical Signal Properties Stage Indicator

This indicator serves as a quick overview of which DSP stage (in *Real-time* mode) or optical signal property computation (*Waveform* mode) is enabled.

Each of the acronyms reflects a bypass check box on one of the configuration tabs. When a bypass check box is set, its corresponding acronym is disabled.

The acronyms are defined as follows:

Table 5 Explanation of DSP / OSP Stage Enabled Indicator acronyms

Acronyms	Explanation
ENC	Encoder stage (always enabled)
PS	Pulse shaper
PN	Phase noise
PC1	First polarization controller stage
PMD	Polarization mode dispersion stage

Acronyms	Explanation
PC2	Second polarization controller stage
NLT	Nonlinear transfer stage
FIR	Corrections stage

Status / Warning / Error Bar

Status Bar

At the bottom of the GUI there is a status bar, showing relevant information about successful operations, such as a completed upload, as well as warnings and errors.

For regular messages, the status bar background color will remain gray, for warnings it will turn yellow, in case of errors it will turn red, as shown in the following pictures:

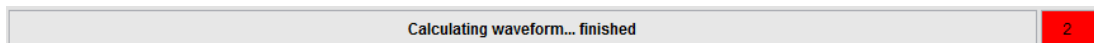

Figure 15 Status Bar showing a regular status message, but indicating error occurrences

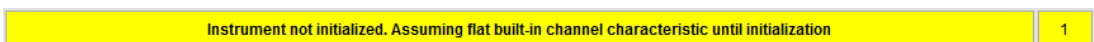

Figure 16 Status Bar showing a warning message



Figure 17 Status Bar showing an error message

Warning / Error Count Box

To the right of the status bar, there's an additional box, showing the number of warnings and errors that have occurred recently. The color of this box is based on the severity of the worst message tracked. If there are only warnings, it is colored yellow, if there were one or more errors, it will be colored red.

By clicking on that box, an additional dialog is opened (see section [Warnings / Errors dialog](#) on page 76), listing all tracked warnings and errors with a time stamp and in some cases additional information about the error (up to a maximum of 100 most recent messages).

Warnings / Errors dialog

This dialog is shown in the [Figure 18](#) on page 76 and described in more detail below.

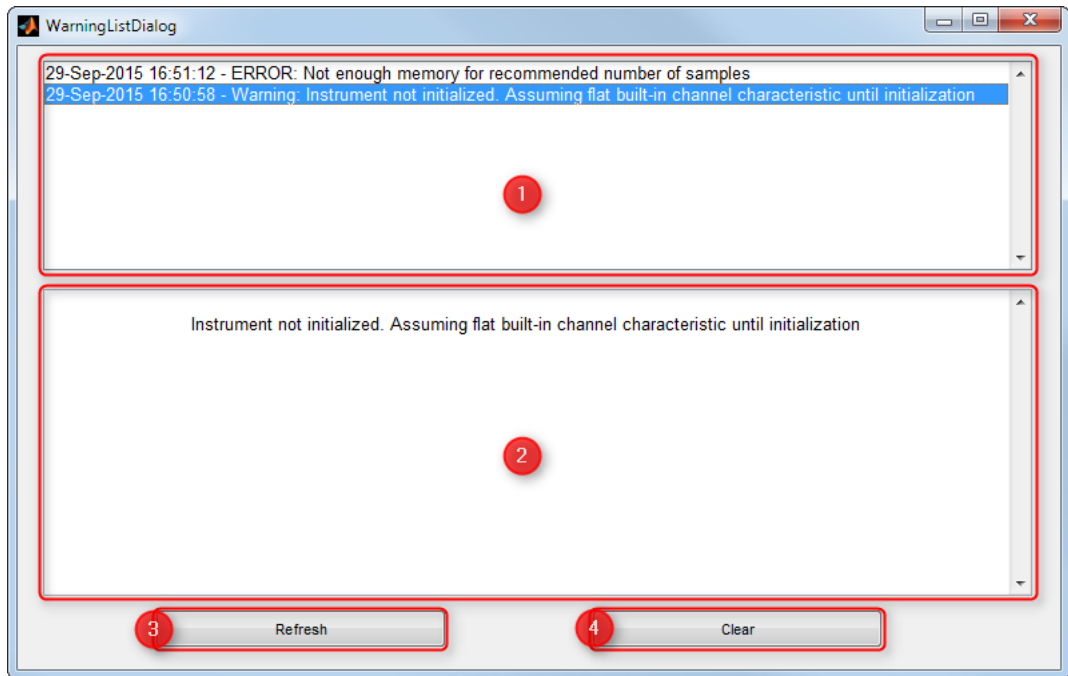

Figure 18 Warnings / Errors dialog

1 List of Messages

This area holds a list of recent warning and error messages (up to a maximum of 100). By clicking on one of the entries, additional information may be displayed in the lower section of this dialog.

2 Message Details

This area shows additional information about the error or warning, if available.

3 Refresh Button

In case this dialog is left open, new messages are not automatically displayed. By clicking the *Refresh* button, the list will be updated.

NOTE

The list will always be updated if it was closed and is opened by clicking the **Warning / Error Count Box** in the main user interface (see [Warning / Error Count Box](#) on page 76).

4 Close Button

This button closes the dialog.

Configuration Tabs

Detailed settings for data generation, modulation format, optical signal properties, impairments, corrections and basic hardware settings are configured on a number of tabs in the main user interface.

Each of these tabs is described in detail in the subsections of chapter [Data Signal Impairment and Hardware Configuration Tabs](#) on page 79.

5 Data Signal Impairment and Hardware Configuration Tabs

Data Signal	/ 80
Pulse Shaping	/ 98
Polarization Mode Dispersion (PMD)	/ 103
Phase Noise / IQ Rotation	/ 112
Polarization	/ 120
Nonlinear Transfer Characteristics	/ 141
Corrections	/ 146
Basic Setup	/ 158

Data Signal

Waveform Input

This tab is used to define the basic (clean) signal parameters. There are three modes of operation, which are selected by the *Waveform pattern* control:

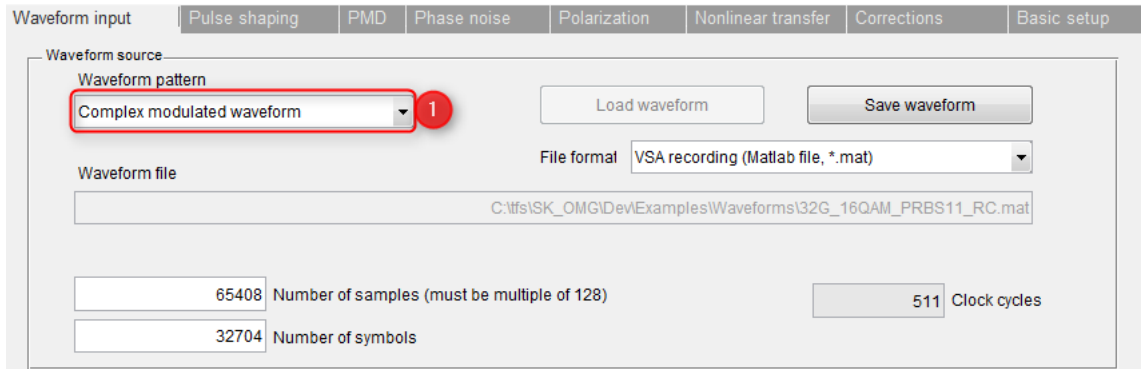

Figure 19 Waveform Input tab

1 Waveform pattern

This control sets the basic signal generation modes. The controls and signal parameter available in each individual mode are explained in detail in the respective sections of this User's Guide.

In *Complex modulated waveform* mode a complex, digitally modulated baseband signal $I+jQ$ (either for single or dual polarization channels) is generated. Signal parameters such as symbol rate, modulation format, etc. can be set in the respective controls in the tab.

The *Standard waveform* mode generates single-tone or multi-tone sinusoidal signal as well as rectangular signals which can be defined on a per-channel basis by providing frequencies, relative amplitudes and offset phases.

In *Load external waveform* mode external waveform files can be imported, which have been saved in any of the other modes or by third-party software (see section [File Formats and Example Files](#) on page 277 for supported file formats).

Available Settings:

- *Complex modulated waveform*
(see [Waveform Input \(Complex modulated waveform mode\)](#) on page 82 for details)
- *Standard waveform* (not available in Real-time Mode)
(see [Waveform Input \(Standard waveform mode\)](#) on page 95 for details)
- *Load external waveform* (not available in Real-time Mode)
(see [Waveform Input \(Load external waveform\)](#) on page 97 for details)

NOTE

Standard waveform input mode and *Load external waveform* mode are not available in real-time mode.

Waveform Input (Complex modulated waveform mode)

In Complex modulated waveform mode the waveform input tab provides controls to specify and define all essentials signal parameters such as symbol rate, modulation format or data source to generate a digitally modulated data signal.

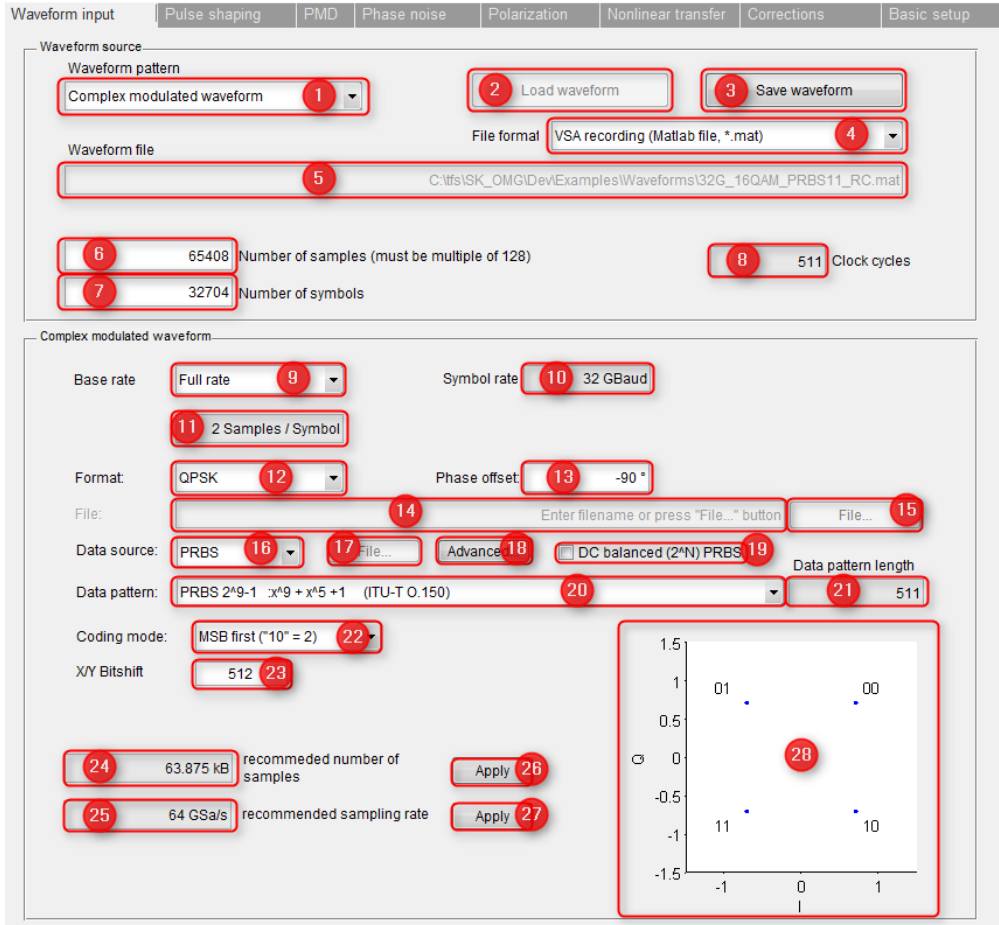

Figure 20 Waveform Input tab (Complex Modulated Waveform Mode)

1 Waveform pattern

This control is described in section **Waveform pattern** on page 80.

2 Load Waveform

This control is inactive in *Complex modulated waveform* mode.

3 Save Waveform

This button starts the computation of the current waveform including all active signal properties and impairments but without applied corrections (frequency response, skew, gain imbalance). A file dialog opens up after a successful calculation of the waveform to save the file in the selected file format.

4 File Format

File format to export (save) and import (load) waveforms

Available Settings:

- CSV file (*.csv)-Text file format
- VSA recording (MATLAB file, *.mat)-MATLAB based binary file format

For detailed description of the available file formats see section [File Formats and Example Files](#) on page 277.

5 Waveform File Name

This control is inactive in *Complex modulated waveform* mode.

6 Number of Samples

This control sets the calculated and generated number of samples (per channel) for the current complex modulated waveform. The number of samples must be an integer multiple of 128 (min. waveform length is 128 samples). The maximum number of samples is equal to the available waveform memory (per channel).

NOTE

In real-time mode this control is disabled and the number of samples will exactly match the number of symbols.

7 Number of Symbols

This control sets the calculated and generated number of symbols (per channel) for the current complex modulated waveform.

NOTE

Changes in this control will automatically adjust the number of samples.

8 Clock Cycles

This control displays the clock cycle length of the current waveform (in multiple of the minimum waveform size of 128) samples.

9 Base Rate

This control sets the base rate of the generated, digitally modulated waveform. From software Rev.2.2, the default setting in waveform mode is *Resampling*, using an arbitrary resampling algorithm.

In *Resampling* mode, a mathematical resampling operation (including anti-aliasing filtering) is applied to generate a waveform corresponding to the desired symbol rate. It allows the generation of symbol rates that are not available as half, quarter or eighth of the DAC's sampling rate.

When using the Real-time Mode or deactivating arbitrary resampling in the *Options* menu, there are three natively supported base rates: full rate, half rate and quarter rate which are $f_s/2$, $f_s/4$ and $f_s/8$ of the instrument's sampling rate f_s , respectively (e.g. $f_s = 64\text{GSa/s} \rightarrow$ Full rate = 32 GBaud, Half rate = 16 GBaud and Quarter rate = 8 GBaud).

Available Settings:

Table 6 Available Settings for Base Rate

Base Rate Mode		Symbol rate
Base Rate setting	Waveform Mode	Real-time Mode
Full rate		Sampling Rate / 2
Half rate		Sampling Rate / 4
Quarter rate		Sampling Rate / 8
Resampling	Arbitrary	Not available

10 Resampling Symbol Rate / Symbol Rate

In resampling mode (default when using waveform mode) you can enter the desired symbol rate. The allowed range depends on the used AWG model type as well as modulation format and data pattern settings.

Using the natively supported *Base Rate* modes (full rate, half rate, quarter rate), controls the displays of actual waveform symbol rate which is based on the sampling rate of module.

NOTE

The lower symbol rate is mainly limited by the available amount of waveform memory whereas the upper limit is theoretically limited by the highest available sampling rate of the DAC (assuming 1 sample per symbol, so that the symbol rate equals the sampling rate). However, waveforms with less than two samples per symbols (i.e. symbol rates are higher than the half of the sample rate of DAC) might observe bandwidth limitations or aliasing effects, hence resulting in decreased signal quality and higher EVM.

NOTE

Resampling automatically determines an appropriate DAC sampling rate and a corresponding resampling factor to achieve the desired symbol rate. Due to the up-sampling process, required in this operation, memory limitations may reduce the range of available symbol rates.

The 81195A OMG offers two different resampling algorithms: arbitrary resampling and fractional resampling. Arbitrary resampling (which is the default mode) offers more flexibility, generally resulting in shorter waveforms.

11 Samples per Symbol

This control displays the number of samples per symbol. For the three natively supported base rates this will result in 2, 4 and 8 samples per symbol respectively. For symbol rates using resampling mode the number of samples per symbol can be a non-integer value or and below 2.

12 Modulation Format

This control sets the modulation format of the complex waveform. You can choose between 9 pre-defined modulation formats (up to 256QAM) or a user-defined mode (constellation and symbol mapping from definition file). For detailed description of file format see section [File Formats and Example Files](#) on page 277.

Available Settings:

- BPSK
- QPSK
- 8-PSK
- 8-QAM

- 16-QAM
- 32-QAM
- 64-QAM
- 128-QAM
- 256QAM
- User defined (only with valid 81195A-OSP license)

NOTE

When operating in *Real-time* mode, changing the modulation format will immediately reconfigure the DSP's encoder to generate the new symbols, but the data pattern will no longer reflect the previously configured settings until *Send Data to Module(s)* is clicked once again.

13 Phase Offset

This control sets an additional rotation angle which rotates the currently used constellation by that angle.

Allowed Range: -180° to 180°

14 User-defined modulation format file name

This control displays or allows to directly set the currently selected file for the user-defined modulation format. For detailed description of file format see section [User-defined modulation file](#) on page 279.

NOTE

Only active when using user-defined modulation format.

NOTE

This mode requires the 81195A-OSP option / license.

15 Select Modulation Format File...

This control opens the file dialog to select a definition file for the user-defined modulation format.

Supported file formats: CSV-file (*.csv) (for detailed description of file format see [User-defined modulation file](#) on page 279.)

NOTE

Only active when using user-defined modulation format.

NOTE

This mode requires the 81195A-OSP option / license.

16 Data Source

This control sets the data source for the encoded symbols. Easiest way and default is to select the *PRBS* mode which uses a single PRBS polynomial for all channels to generate the symbol pattern used for digital modulation.

Selecting the *Patternfile* mode lets you specify an external bit pattern file used for symbol pattern generation (e.g. for polynomials not available in list or other specific data patterns). Like in *PRBS* mode a single pattern file will be used for all channels.

Finally the *Advanced* mode offers full flexibility and allows specifying different PRBS polynomials or pattern files used for X and Y channels or for I and Q pairs. Please note that the *Advanced* mode uses a separate user interface which is explained in detail in section [Data Pattern](#) on page 92.

Available Settings:

- PRBS
- Patternfile
- Advanced

17 Data Pattern File...

This control opens a file dialog to select a data pattern file used for digital modulation. The supported file format is a J-Bert pattern file (*.ptrn).

NOTE

For more details on this file format please see section [Data pattern file](#) on page 280.

18 Advanced Pattern...

This control opens the *Advanced* mode user interface. In PRBS or Patternfile mode the advanced mode user interface can be opened as well however most controls will be disabled and grayed out.

19 DC (2n) PRBS

This checkbox defines whether to use the standard 2^n-1 PRBS pattern for symbol pattern generation or the corresponding $2n$ PRBS pattern.

The difference between 2^n PRBS patterns and the standard 2^n-1 PRBS pattern is that the 2^n PRBS pattern (using the same polynomial) contains an additional zero bit which results in making the total length even. Furthermore the additional zero bit yields a perfectly DC-balanced sequence hence also calling these PRBS patterns DC-balanced PRBS.

As explained in [1], the additional zero bit is inserted at the end of the longest run of zeros in the corresponding 2^n-1 PRBS pattern.

Since 2^n PRBS patterns inherently align with the mandatory 128 sample granularity of the waveform memory (see [Clock Cycles in Real-time Mode](#) on page 37) they are suited very well to fit into the memory even for high-order PRBS polynomials.

20 Data Pattern

In PRBS source mode this control lets you select and choose from a number of standard PRBS polynomials to be used for symbol pattern generation.

Symbol patterns using PRBS polynomials not available in this list must be generated using pattern file import.

In Pattern File mode this control displays the current pattern file.

Available Settings:

- PRBS 2^7-1 : $x^7 + x^1 + 1$ (N439x app.)
- PRBS 2^7-1 : $x^7 + x^6 + 1$ (non standard)
- PRBS 2^9-1 : $x^9 + x^5 + 1$ (ITU-T O.150)
- PRBS $2^{11}-1$: $x^{11} + x^9 + 1$ (ITU-T O.150)
- PRBS $2^{15}-1$: $x^{15} + x^{14} + 1$ (ITU-T O.150)
- PRBS $2^{15}-1$: $x^{15} + x^1 + 1$ (N439x app.)
- PRBS $2^{20}-1$: $x^{20} + x^3 + 1$ (1)
- PRBS $2^{20}-1$: $x^{20} + x^{17} + 1$ (2)
- PRBS $2^{23}-1$: $x^{23} + x^5 + 1$ (1)
- PRBS $2^{23}-1$: $x^{23} + x^{18} + 1$ (2)
- PRBS $2^{29}-1$: $x^{29} + x^2 + 1$
- PRBS $2^{31}-1$: $x^{31} + x^3 + 1$ (1)

- PRBS $2^{31}-1$: $x^{31} + x^{28} + 1$ (2)

See listed ITU-T reference document [2] for further details about PRBS pattern.

NOTE

PRBS polynomial from this list can be generated as 2n PRBS pattern using the DC(2n) PRBS checkbox.

21 Data Pattern Length

This control displays the length of the current data pattern in *PRBS* or *pattern file* mode

22 Coding Mode

This drop down menu defines the symbol encoding mode.

Available Settings:

- MSB first („10“ = 2)
- LSB first („10“ = 1)

When choosing *MSB first* the required number of bits is taken from the bit pattern (example below showing a QPSK) and encoded to a symbol interpreting the first bit as most significant one. Accordingly the *LSB first* mode interprets the first bit as least significant bit.

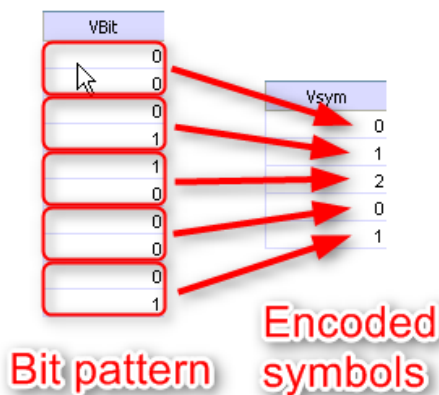

Figure 21 Bit pattern to symbol mapping

23 X/Y Bitshift

This control defines the bit shift between the bit patterns used for the X and Y complex IQ channels. A positive value delays the Y bit pattern by the given number of bits with respect to the X bit pattern. The bit patterns are shifted in a circular way, i.e. shifting exactly by the bit pattern length results the primary pattern.

NOTE

This control is only active in PRBS and Pattern file data source mode and in dual IQ pair (4 channels) operation.

24 Recommended Number of Samples

This control displays the recommended waveform/symbol pattern length (= number of samples) for the given combination of bit pattern lengths and internal sampling rate.

Depending on the chosen data pattern and internal sampling rate the number of samples must be adjusted to meet the given hardware restrictions and ensure the correct replay of the pattern.

A warning will be displayed if the recommended number of samples exceeds the available waveform memory.

NOTE

To enable/disable the automatic appliance of the recommended number of samples and sampling rate see menu [Options](#) on page 51.

25 Recommended Sampling Rate

This control displays the recommended internal sampling rate for the given data pattern and symbol rate.

NOTE

To enable/disable the automatic appliance of the recommended number of samples and sampling rate see menu [Options](#) on page 51.

26 Apply Recommended Number of Samples

Clicking this button applies the recommended number of samples as the new number of samples depending on given restrictions (available waveform memory).

NOTE

To enable/disable the automatic appliance of the recommended number of samples and sampling rate see menu [Options](#) on page 51.

27 Apply Recommended Sampling Rate

Clicking this button applies the recommended sampling rate as the new internal sample frequency depending on given restrictions.

Allowed Range:53.8 GHz...65 GHz

NOTE

To enable/disable the automatic appliance of the recommended number of samples and sampling rate see menu [Options](#) on page 51.

28 Constellation plane

This plot shows the constellation of the currently selected modulation format in the complex plane including phase offset. The symbol mapping is exemplary shown for the corner symbols.

Data Pattern

The *Data Pattern* GUI opens up after clicking on the *Advanced...* button and displays the detailed information about the current data pattern settings. In *PRBS* and *Pattern file* mode all control elements in the *Data Pattern GUI* are disabled but still display the current settings.

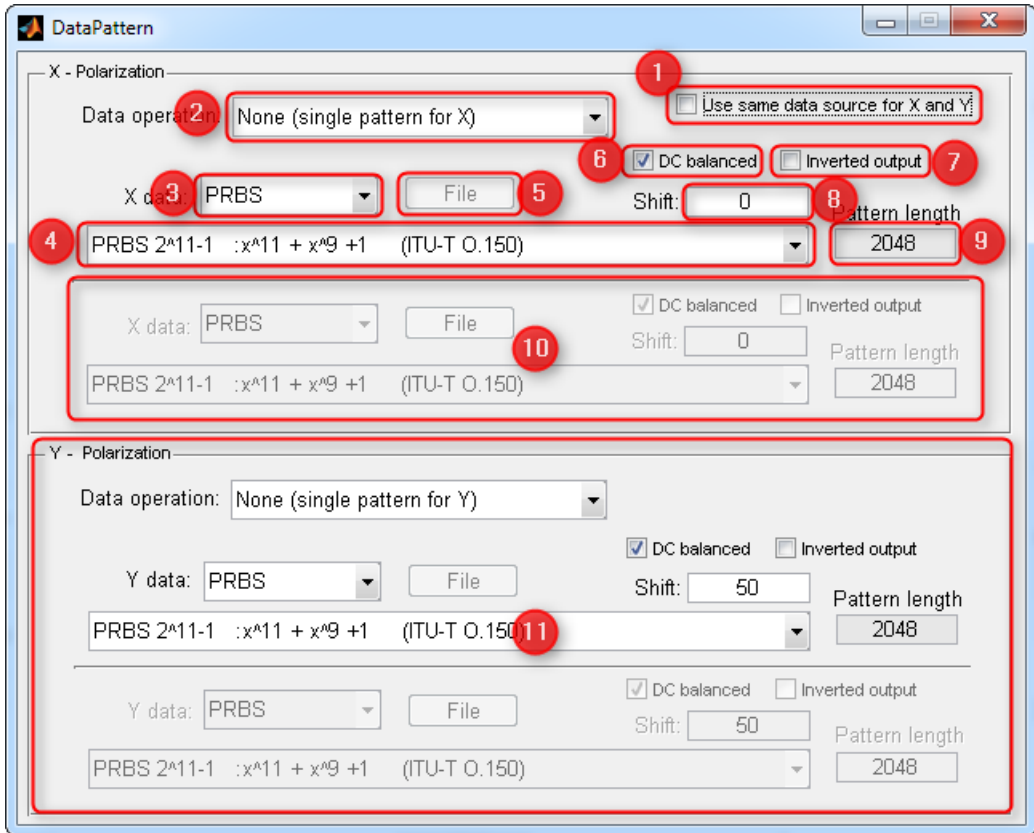

Figure 22 Advanced Data Pattern dialog

1 Use same data source for X and Y polarization

If this check box is set, all data settings from the X polarization (except for the bit shift) will also be applied to the Y polarization. The Y polarization control will be disabled in that case.

2 Data operation

Using this control you can select between a single data pattern for the X (or Y) polarization channel or using different data sources for the I and Q channels (I+jQ operation)

Available Settings:

- None (single pattern for X/Y)
- I+jQ (separate pattern for I/Q)

3 Channel source

This control selects the data source for the corresponding channel between *PRBS* and *Patternfile*. See also [This control sets the data source for the encoded symbols. Easiest way and default is to select the PRBS mode which uses a single PRBS polynomial for all channels to generate the symbol pattern used for digital modulation.](#) on page 87.

Available Settings:

- PRBS
- Patternfile

4 Data pattern

This control selects or displays the current data pattern (either PRBS polynomial or pattern file)

For detailed description see [Data Pattern](#) on page 88.

5 Data pattern file...

This control opens the file dialog to select a pattern file in *Patternfile* source mode

For detailed description see [Data Pattern File...](#) on page 87.

6 DC (2n) PRBS

This control toggles between standard PRBS and DC-balances PRBS mode. When active and in PRBS source mode the currently selected PRBS pattern will be generated as DC-balanced 2n PRBS pattern.

For detailed description see [DC \(2n\) PRBS](#) on page 88

7 Inverted pattern

If activated this checkbox inverts the bit pattern output for this channel.

8 Pattern shift

This control shifts (i.e. delays) the bit pattern output on this channel by the given amount of bits. For example setting this value to 50, the first bit that is output on this channel would be bit number 50 from the PRBS / pattern file.

NOTE

Bit shifts are made in a circular way, i.e. the last bit from the pattern will be followed again by the first, second.

9 Pattern length

This control displays the pattern length for this channel

10 Q channel data

This group of controls provides all settings for the XQ channel when using the I+jQ operation for the X polarization channel.

11 Y channel data

This group of controls provides all settings for the Y polarization channel when using different data sources for the X and Y polarization channels (deactivate “Use same data source for X and Y”).

Waveform Input (Standard waveform mode)

In standard waveform mode the waveform input tab provides controls to generate standard waveforms such as single tone sinusoidal waves or multi tone sinusoidal waves.

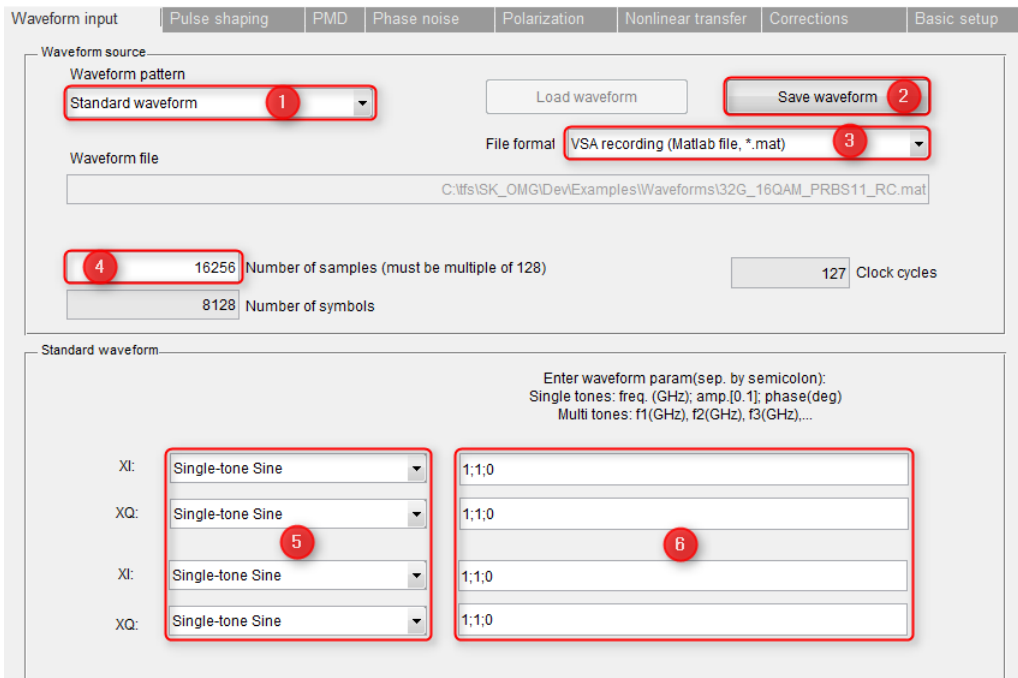

Figure 23 Waveform Input tab (Standard Waveform Mode)

1 Waveform pattern

This control is described in section **Waveform pattern** on page 80.

Save Waveform

This control is described in section **Save Waveform** on page 83.

2 File Format

This control is described in section **File format to export (save) and import (load) waveforms** on page 83.

3 Number of Samples

This control displays the number of samples used to generate the specified waveform.

4 Waveform pattern

These controls select the basic waveform pattern for the respective channels. Single-tone Sine waveforms contain just a single frequency sine whereas Multi-tone Sine waveforms are a sum of multiple sinusoidal waves with given frequencies.

Available Settings:

- Single-tone Sine
- Multi-tone Sine
- Rectangular

5 Waveform parameters

These controls specify the waveform parameters for each channel, depending on the selected waveform pattern.

For Single-tone Sine and Rectangular signals please enter the frequency (in GHz), amplitude (0..1) and phase (in degree), separated by semicolons.

For Multi-tone Sine enter the frequency list of base tones (in GHz), separated by semicolons.

Waveform Input (Load external waveform)

In standard waveform mode the waveform input tab provides controls to load saved waveforms from previously calculated signals or files generated by other tools.

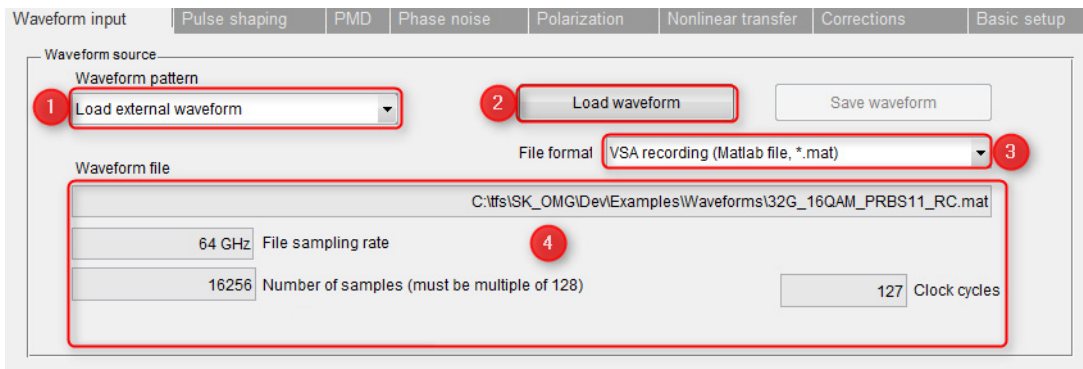

Figure 24 Waveform Input tab (Load External Waveform Mode)

1 Waveform Pattern

This control is described in section **Waveform pattern** on page 80.

2 Load Waveform

This control opens the file dialog to load and import a file in the selected file format containing a waveform.

For detailed description of the available file formats see section **This control is inactive in Complex modulated waveform mode.** on page 83.

3 File Format

This control is described in section **File format to export (save) and import (load) waveforms** on page 83

4 Waveform File display

This block of controls displays the currently selected waveform file, the nominal file sampling rate and the number of samples, symbols and clock cycles.

Pulse Shaping

Theory

In digital telecommunication systems, pulse shaping is used to vary the temporal amplitude of the transmitted data signal's pulses [3, p. 285ff]. The main purpose for this is to shape the spectrum of the transmitted signal to either fit a narrower transmission channel, thus, optimizing bandwidth efficiency or to reduce intersymbol interference, caused by the transmission channel. The actual pulse shaping is done by applying an appropriate pulse shaping filter to the transmitted signal.

There are different types of filters which satisfy the conditions mentioned above and which are commonly used in digital communication systems. These filters can be defined and described either in time domain or frequency domain. In literature usually their names are based on the shape in the domain that the filter can be described in most conveniently. There is a special case when the pulse shaping filter is split, using identical filters on transmitter and receiver side. These filters are called matched filters and the filter amplitude spectrum of each of these individual filters is the square root of the desired target filter. Using this approach yields optimum linear filtering in terms of SNR in the presence of additive white Gaussian noise (AWGN).

Table 7 Pulse shaping filter properties

Pulse shaping filter (named after spectrum shape)	Pulse shape in time domain	Amplitude spectrum in frequency domain
Rectangular filter	Sinc pulse $(\sin(x)/x)$ (infinite impulse response)	Rectangular / Boxcar shape
Sinc filter	Rectangular pulse	Sinc shape
Raised cosine filter (matched filter)		Non-zero portion of cosine function
Root-raised cosine filter		Square root of raised cosine filter
Gaussian filter	Gaussian pulse	Gaussian shape

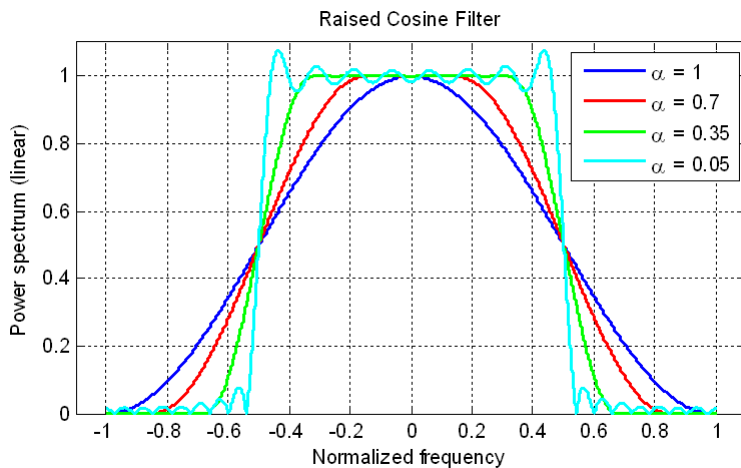

Figure 25 Spectrum of a pulse shaping filter using a raised-cosine filter with different roll-off factors

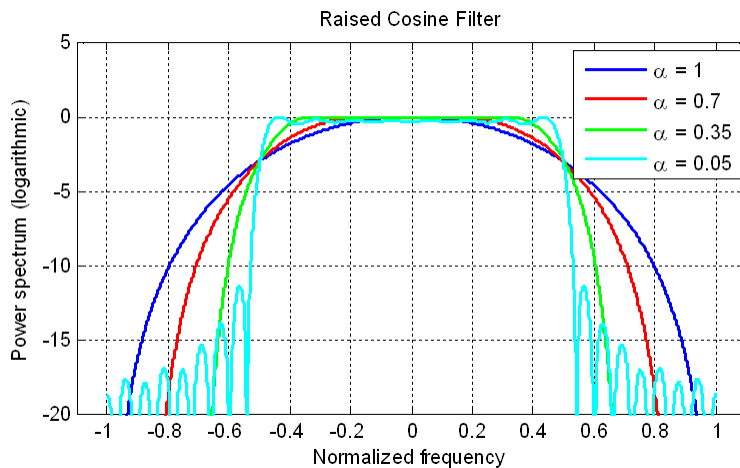

Figure 26 Spectrum (log) of a pulse shaping filter using a raised-cosine filter with different roll-off factors

In the 81195A optical modulation generator software the pulse shaping is realized in time domain by means of a digital FIR filter. Depending on the used hardware configuration and signal parameters either 32 or 64 filter taps are available for the implementation of the pulse shaping filter (see [Table 3](#) on page 39).

Pulse Shaping

The pulse shaping tab provides controls to specify and apply different pre-defined pulse shaping filters to the generated waveform. Furthermore you can define your own filter by providing a file containing 32 or 64 filter coefficients to be used in the FIR filter.

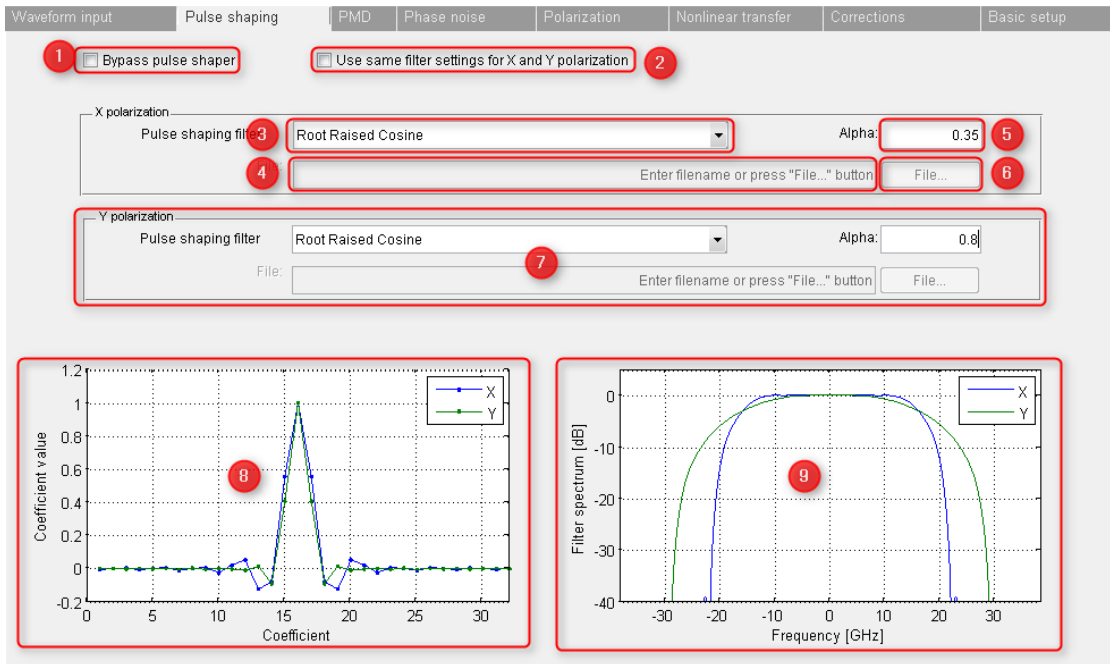

Figure 27 Pulse Shaping tab

1 Bypass pulse shaper

This check box enables or bypasses the pulse shaping filter in the signal generation path.

2 Use same filter settings for X and Y

This check box enables or disables the controls for the Y polarization. If the check box is set the same filter settings are used for X and Y polarization (default).

3 Pulse shaping filter type

This control selects the filter shape from a pre-defined list of filters. For user-defined filters select *User Define* from the drop down menu and select a file containing filter coefficients. Most filter shapes are defined in frequency domain (Raised and root-raised cosine, Gaussian), however the listed *Rectangular* filter refers to a rectangular pulse in time domain.

NOTE

The ideal rectangular filter (sinc pulse shape, see table at [Theory](#) on page 98) cannot be realized in hardware due to its infinite impulse response. An approximation of it can be realized by choosing a Raised Cosine filter with roll-off factor of 0 (resulting in a truncated sinc impulse response).

Available Settings:

- Root-raised cosine
- Raised cosine
- Gaussian
- Rectangular
- User Defined (only with valid 81195A-OSP license)

4 Pulse shaping filter filename

This field displays or allows to directly set the currently selected user-defined filter file for the pulse shaper.

NOTE

For more details on this file format please see section [Pulseshaper file](#) on page 280.

NOTE

This mode requires the 81195A-OSP option / license.

5 Alpha / BT

This control sets additional filter parameters for some filter types. For Raised Cosine and Root-raised Cosine filters you can enter the roll-off factor alpha. For the Gaussian type filter you can enter the bandwidth time product BT.

Allowed Range:0.05 ... 1

6 Filter file...

This control opens the file dialog to select a user define filter file containing 32 or 64 filter coefficients. The number of coefficients depends on the *Base rate Mode* and *PMD Mode* settings (see [Table 3](#) on page 39 for details).

NOTE

For more details on this file format please see section [Pulseshaper file](#) on page 280.

NOTE

This mode requires the 81195A-OSP option / license.

7 Filter controls for Y polarization

This group of controls duplicates all controls from the X-polarization filter settings and is only active with disabled check box. Use same filter settings for X and Y polarization.

8 Filter impulse response

This plot shows the current filter impulse response(s).

9 Filter spectrum

This plot shows the current filter amplitude spectrum/spectra in logarithmic scale.

Polarization Mode Dispersion (PMD)

Theory

Generally the term polarization mode dispersion (PMD) describes an optical effect that is present when light passes through a concatenation of birefringent elements. It can be represented by a vector $\vec{\tau}$, which points in the direction of the system's slow principal state (PSP) \hat{p} , and its length is the differential group delay (DGD) τ between the slow and the fast PSP.

The DGD value is often referred to as the 1st order PMD. The PMD vector $\vec{\tau}$ itself is a frequency-dependent parameter and thus should be not mixed up with the mean differential group delay of an optical fiber that is a statistical scalar value and also often referred to as PMD value in literature.

The vector difference between two PMD vectors $\vec{\tau}(\omega_1)$ and $\vec{\tau}(\omega_2)$ for $|\omega_1 - \omega_2| \rightarrow 0$ is defined as second-order PMD (SOPMD) vector $\vec{\tau}_\omega$.

Its parallel component $\vec{\tau}_{\omega\parallel}$ is referred to as polarization-dependent chromatic dispersion (PDCD) and the perpendicular component $\vec{\tau}_{\omega\perp}$ as depolarization.

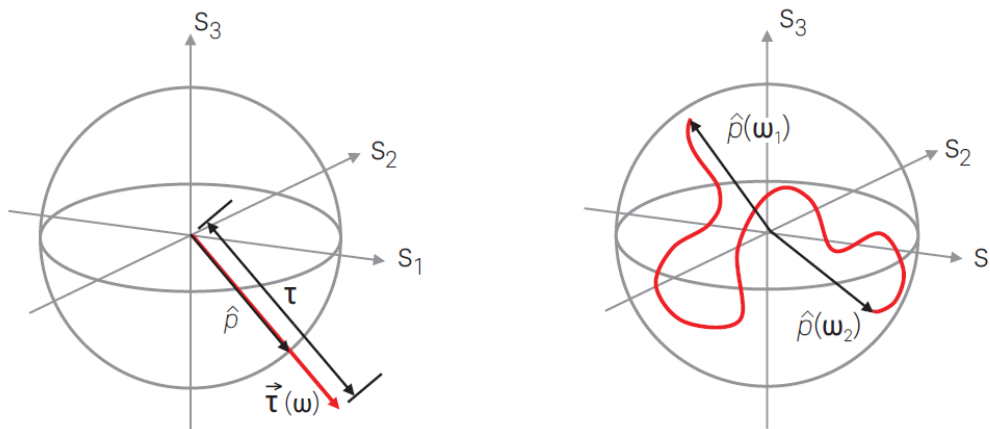

PMD vector in Stokes space

PSP spectrum

Figure 28 Representation of PMD on Poincaré Sphere

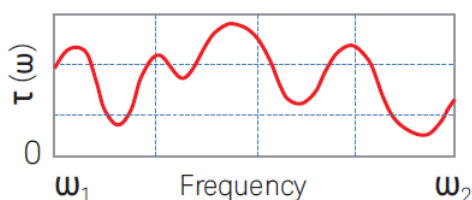

DGD spectrum

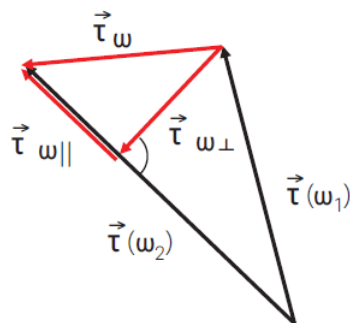

Definition of second-order PMD (SOPMD) vector

Figure 29 Definition of second-order PMD

Like chromatic dispersion (CD) PMD is a linear optical effect. However it differs from CD in that it is a time-varying, dynamic effect which makes the emulation and compensation more difficult.

In digital signal processing (like in the DSP of the M8195A) PMD is emulated using a butterfly FIR filter structure with complex impulse responses h_{xx} , h_{yx} , h_{xy} and h_{yy} as shown in [Figure 30](#) on page 105 (similar to PMD compensation filters at receiver side). The complex filter coefficients can be calculated based on the standard PMD model of concatenated lossless birefringent segments ([Figure 32](#) on page 106). The PMD filter in the M8195A AWG and 81195A software features a 7-tap FIR structure which is equivalent to a PMD emulator comprising 7 birefringent segments each having a DGD of twice the AWG sampling interval.

NOTE

In half or quarter base rate mode (see [This control sets the base rate of the generated, digitally modulated waveform. From software Rev.2.2, the default setting in waveform mode is Resampling, using an arbitrary resampling algorithm. on page 84](#)) the number of filter taps and thus the emulated number of segments increases to 14.

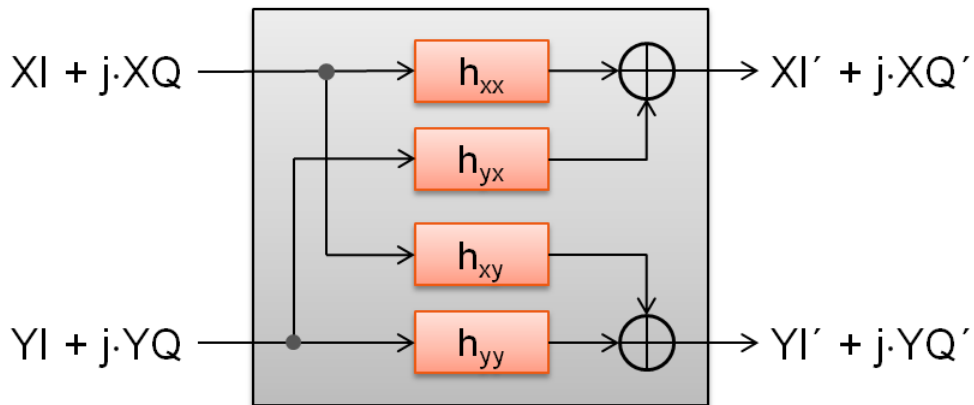
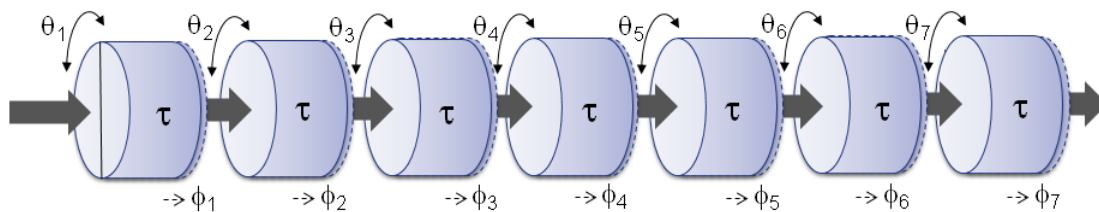

Figure 30 PMD Filter Structure

Figure 31 Model of concatenated birefringent sections each with retardation τ , axis angle θ and output phase ϕ

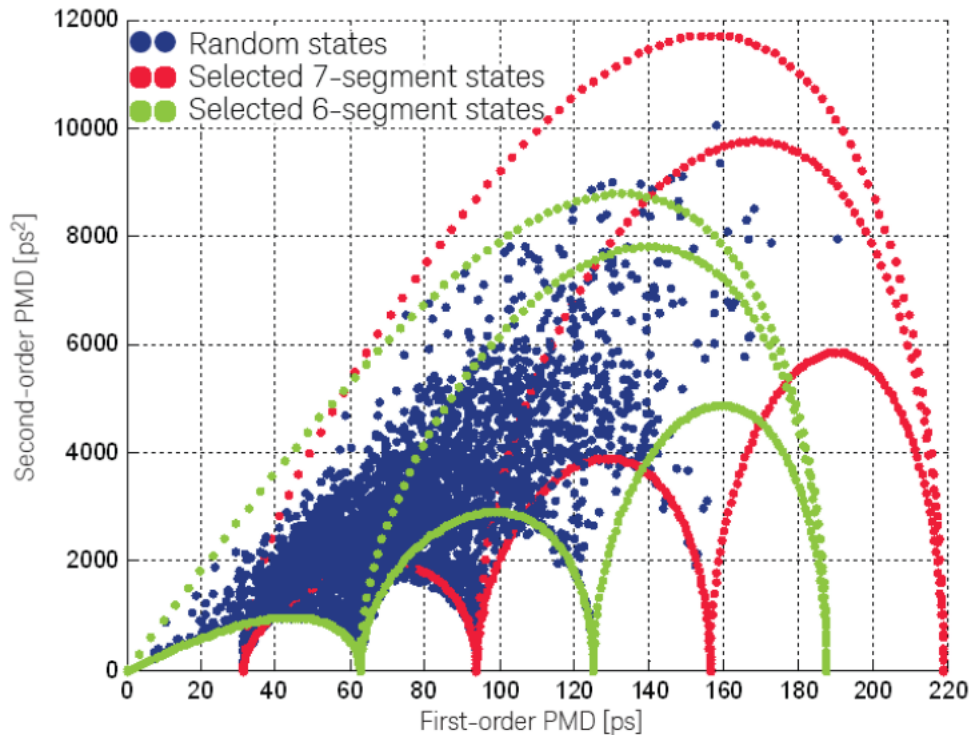

Figure 32 Addressable PMD space (exemplary states)

Polarization Mode Dispersion (PMD)

The PMD tab offers two basic modes to use the complex butterfly FIR filter structure. You can either provide the pure filter coefficients in a file (*Use complex FIR file mode*) to realize your own filter or use the standard PMD model by changing the parameters (rotation angle and residual phase) of the 7 (14 in half and quarter rate mode) concatenated birefringent segments. Using these segment controls for the available segments you can then manually set the desired PMD state, described by its DGD and SOPMD spectrum and PMD, SOPMD, Depolarization and PCD values. Additionally you can load specific pre-defined PMD states as well as save and reload the current PMD filter settings.

NOTE

This tab requires the 81195A-OSP option, so it will be disabled without a valid 81195A-OSP license being installed.



Figure 33 PMD tab (Concatenation of birefringent segments)

1 Bypass PMD block

This check box enables or bypasses the PMD filter in the signal generation path.

2 Use complex FIR file mode

This check box enables the complex FIR file mode which allows to program user defined PMD FIR filter coefficients. See [Polarization Mode Dispersion \(PMD\) – User defined coefficients](#) on page 110 for more details.

3 PMD Mode

This drop down menu selects the PMD mode. With *Base Rate Mode* set to *Full Rate* mode, only 7 segments are available for the underlying PMD model. In *Half Rate* or *Quarter Rate* mode you can either choose between a 7 or 14 segments mode. [Table 8](#) on page 108 explains the different modes.

Available Settings:

- 7seg. x Segment DGD in ps
- 14seg. x Segment DGD in ps

Table 8 List of PMD Mode

Base rate Mode ($T_{\text{sym}} = 1/\text{symbolrate}$)	7 Segment Mode DGD per segment	14 Segment Mode DGD per segment	Max. first-order PMD
Full rate	T_{sym}	N.A.	$7 \times T_{\text{sym}}$ (= 218.75ps@32GBaud)
Half rate Quarter rate	T_{sym}	$T_{\text{sym}}/2$	$7 \times T_{\text{sym}}$ (= 437.5ps@16GBaud) (= 875ps@8GBaud)

4 Load predefined patterns

This drop down menu offers different pre-defined PMD states which are loaded when selected.

Available Settings:

- Zero DGD
- Min. pure first order

Single segment PMD

- Min. first order
- Max. first order

All segments aligned

- Random

Loads random PMD state using the current seed value

5 Randomizer Seed

This control displays or sets the randomizer seed value used to generate the random PMD state.

Allowed Range:0 ... 1e9

6 Randomize PMD state

Clicking this button generates a new random PMD state and displays the used seed value.

7 Segment enable

The segment enable check box enables or disables the corresponding segment, i.e. controls if the segment contributes in the PMD model.

8 Segment rotation angle

These controls (slider and numeric value) can be used to set the axis rotation angle θ (with respect to the reference axis) of the corresponding segment (see [Figure 31](#) on page 105).

Allowed Range:-180° ... 180°

9 Segment residual phase

This control can be used to set the residual (output) phase ϕ of the corresponding segment (see [Figure 31](#) on page 105).

Allowed Range:0 ... 360°

10 Link segment phases

When enabled this check box sets the (residual) phases ϕ for all segments to the same value.

11 Segment controls

This group offers enable, rotation angle and phase controls for all available segment.

12 PMD scalar values

These fields display the PMD, SOPMD, Depolarization and PCD values for the current PMD state.

13 DGD spectrum

This plot shows the DGD spectrum (differential group delay vs. signal frequency) for the current PMD state.

14 SOPMD spectrum

This plot shows the SOPMD spectrum (second-order PMD vs. signal frequency) for the current PMD state.

Polarization Mode Dispersion (PMD) – User defined coefficients

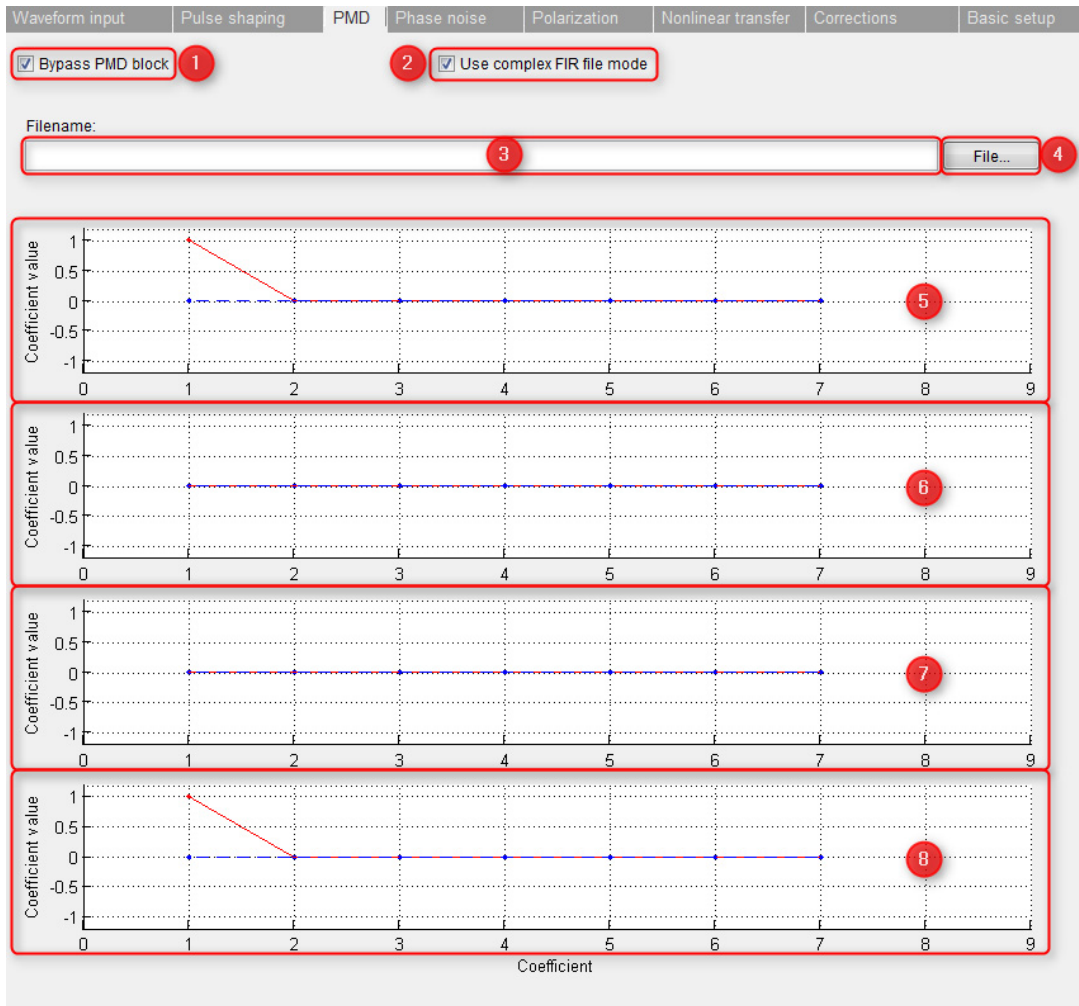

Figure 34 PMD tab (User-defined coefficients)

1 Bypass PMD block

This control is described in section **Bypass PMD block** on page 108.

2 Use complex FIR file mode

This control is described in section **Use complex FIR file mode** on page 108.

3 PMD filter filename

This control displays or allows to directly set the currently selected PMD filter file.

NOTE

For details about the supported file format see [Pulseshaper file](#) on page 280.

4 PMD filter file...

This control opens the file dialog to select a complex PMD filter file.

NOTE

For details about the supported file format see [Pulseshaper file](#) on page 280.

5 Complex Impulse Response Hxx

This plot displays the complex impulse response for the Hxx FIR filter (see [Figure 30](#) on page 105)

6 Complex Impulse Response Hyx

This plot displays the complex impulse response for the Hyx FIR filter (see [Figure 30](#) on page 105)

7 Complex Impulse Response Hxy

This plot displays the complex impulse response for the Hxy FIR filter (see [Figure 30](#) on page 105)

8 Complex Impulse Response Hyy

This plot displays the complex impulse response for the Hyy FIR filter (see [Figure 30](#) on page 105)

Phase Noise / IQ Rotation

Theory

Laser phase noise is a random process, originating from spontaneous emission (ASE) of photons, which induces a phase variation that results in a finite nonzero spectral linewidth of the laser. It is an important issue in coherent optical transmission systems since it adds a BER floor in coherent receivers using digital signal processing [4].

Laser phase noise has the effect of adding a random walk phase to the complex signal which, as a consequence, randomly distributes the signal constellations points on a circle.

The phase noise emulation feature now allows to add artificial phase noise to a complex waveform $c(t)$ thus emulating laser phase noise and/or a constant frequency offset by rotating the IQ pairs of the signal by a time-dependent rotation angle $\theta(t)$.

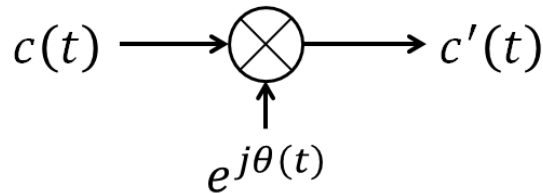

Figure 35 Illustration of adding phase noise to a complex signal

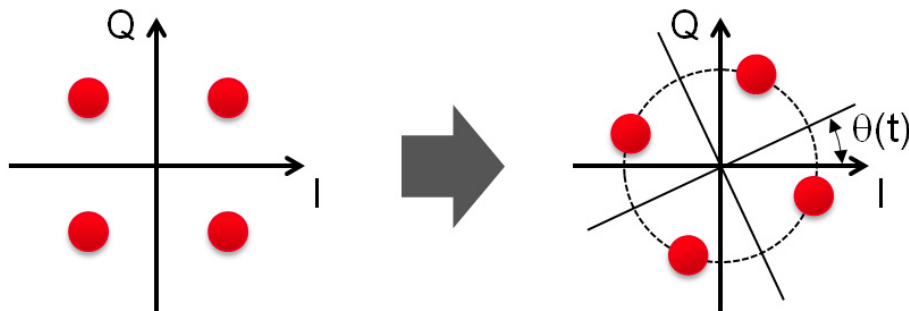

Figure 36 Illustration of the effect of phase noise / IQ rotation on the constellation diagram

The calculation of the phase noise and rotation angle pattern respectively is based on a laser phase noise model considering three contributions to the phase noise power spectral density (PSD). Find details of the underlying model in [5].

NOTE

When operating in real-time mode, the phase rotation pattern is independent of the symbol data pattern and always uses all the available phase rotation pattern memory. When operating in waveform mode, the phase rotation pattern length is based on the symbol pattern length instead, to ensure a continuous phase rotation. In consequence, short symbol data patterns contain short phase noise patterns and, thus, may not reflect the desired statistics very well. In this case the software will automatically increase the recommended number of samples by repeating the data pattern, depending on the available memory.

Phase Noise / IQ Rotator Tab

The phase noise tab provides controls to add a define phase rotation pattern to the generated waveform. This pattern can either be calculated automatically using the laser phase noise model [5] or provided from the user by a file containing a rotation angle pattern (see [Phase Noise / IQ rotator pattern file](#) on page 281 for pattern definition file).

Additionally the tab provides controls to add a static rotation to the waveform which results in a frequency shift of the output signal.

NOTE

This tab requires the 81195A-OSP option, so it will be disabled without a valid 81195A-OSP license being installed.

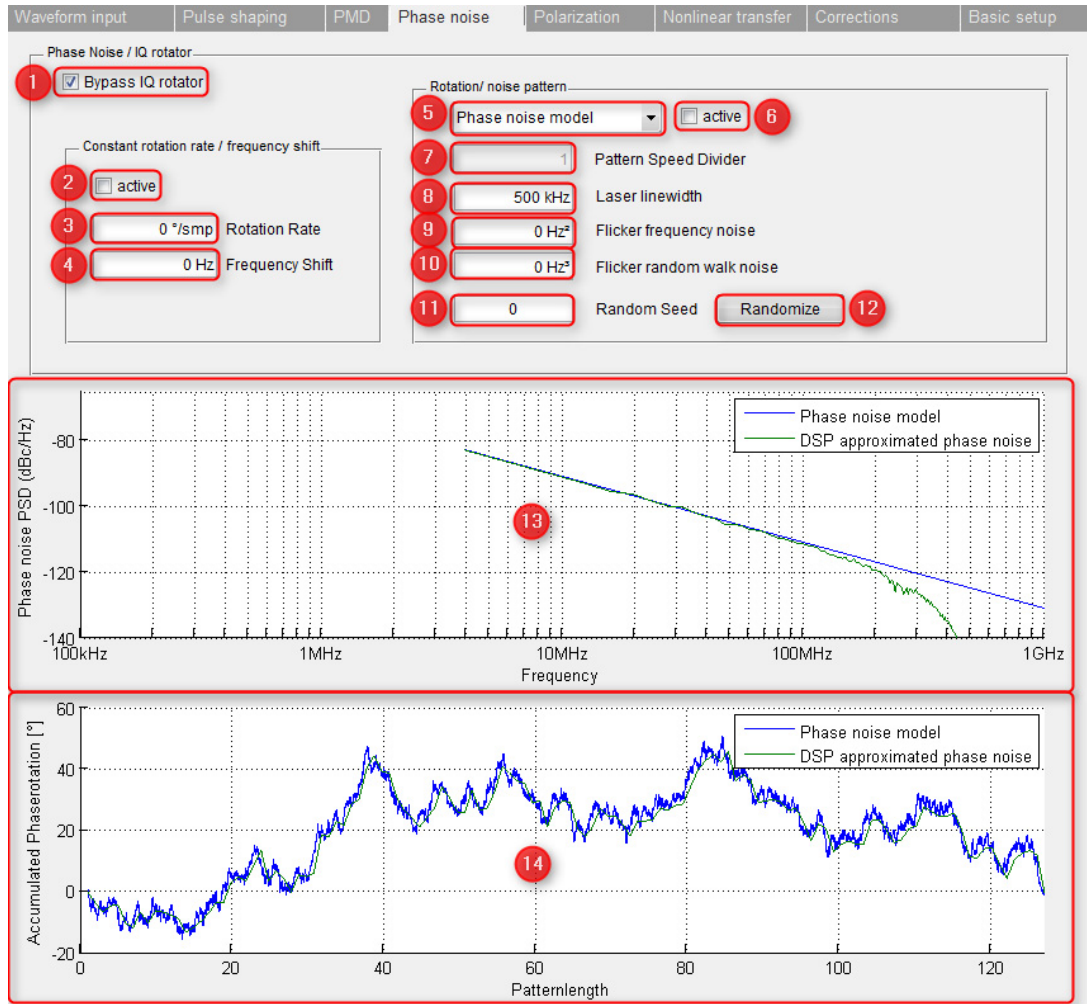

Figure 37 Phase Noise tab

1 Bypass IQ Rotator

This check box enables or bypasses the IQ rotation block in the signal generation path.

NOTE

When using real-time mode, the bypass check box can be used to start stop pattern playback. However, even with bypass unchecked, the DSP stage may be configured to wait for a trigger condition (see section [Input and Output Triggers](#) on page 29).

2 Enable constant rotation

This check box enables or disabled the constant rotation / frequency shift.

3 Rotation Rate

This control sets the constant rotation rate and updates automatically the corresponding frequency shift value in **Frequency Shift** on page 115. The entered value is interpreted as rotation angle in degree per sample period.

Allowed Range: $-16^\circ \dots +16^\circ$ per sample period ($^\circ/\text{smp}$)

Resolution: 0.0039° (approx.. $0.7\text{MHz}@\text{fs}=64\text{GSa/s}$)

4 Frequency Shift

This control sets the constant rotation rate and updates automatically the corresponding rotation rate value in **Rotation Rate** on page 115.

Allowed Range: $-2.84\text{GHz} \dots +2.84\text{GHz}$

Resolution: approx. $0.7\text{MHz}(@\text{fs}=64\text{GSa/s})$

5 Phase Noise Pattern Mode

This drop down menu selects between phase noise generation using the given phase noise model or loading a user defined rotation pattern file. A rotation pattern with up to 1024 coefficient sets is supported.

Available Settings:

- Phase noise model
- User defined pattern

6 Enable Phase Noise Pattern

This check box enables or disabled the rotation/noise pattern.

7 Pattern Speed Divider

This control sets a pattern speed divider which can be used to slow down the currently used rotation / phase noise pattern. Default value is 1 which advances one pattern step every 128 samples. Entering higher number (up to 30) slows down the pattern advance rate by that factor (e.g. a speed divider value of 4 means advancing one pattern step only every 512 samples).

The result of slowing down the pattern advance rate is shifting the phase noise spectrum towards lower frequency and decreasing the cut-off frequency.

Allowed Range: 1, 2, ... 30

NOTE

This control is only available in real-time mode.

8 Laser Line Width

This control sets the laser line width used to generate the rotation angle pattern based on the phase noise model described in [5].

NOTE

This control is only available when using the phase noise model mode.

9 Flicker Frequency Noise

This control sets the amount of flicker frequency noise used to generate the rotation angle pattern based on the phase noise model described in [5].

NOTE

This control is only available when using the phase noise model mode.

10 Flicker Random Walk Noise

This control sets the amount of flicker random walk noise used to generate the rotation angle pattern based on the phase noise model described in [5].

NOTE

This control is only available when using the phase noise model mode.

11 Randomizer Seed

This control displays or sets the randomizer seed value used to generate the rotation pattern.

Allowed Range:0 ... 1e9

NOTE

This control is only available when using the phase noise model mode.

12 Randomize rotation pattern

Clicking this button generates a new random rotation pattern based on the entered laser linewidth and flicker noise contributors and displays the used seed value.

NOTE

This control is only available when using the phase noise model mode.

13 Phase noise PSD

This plot displays the phase noise power spectral density (PSD) for the current rotation pattern. When using the phase noise model mode two graphs are displayed, one showing the PSD of the originating phase noise model the other showing the actual phase noise generated by the DSP approximation.

14 Rotation pattern angle

This plot displays the current phase rotation pattern. Shown are the ideal rotation pattern (from originating phase noise model) and the DSP approximation (due to quantization constraints).

Phase Noise (User defined pattern)

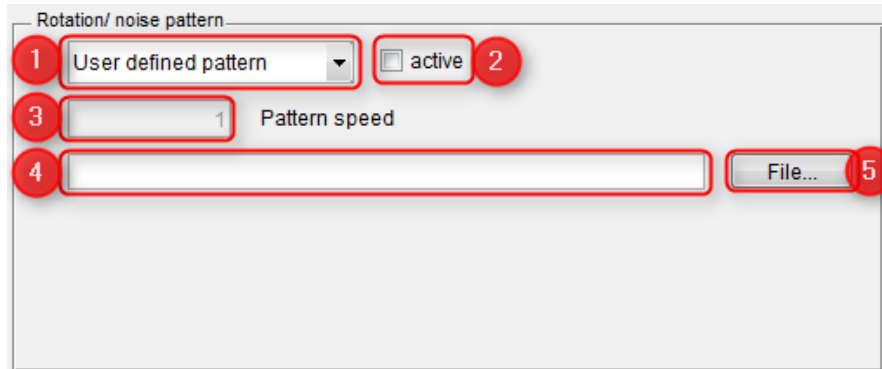

Figure 38 Phase Noise tab (User-defined pattern mode)

1 Phase Noise Pattern Mode

This control is described in section **Phase Noise Pattern Mode** on page 115.

2 Enable Phase Noise Pattern

This control is described in section **Enable Phase Noise Pattern** on page 115.

3 Pattern Speed Divider

This control is described in section **Pattern Speed Divider** on page 116.

4 Rotation pattern filename

This control displays or allows to directly set the currently selected rotation pattern file.

NOTE

For details about the supported file format see [Phase Noise / IQ rotator pattern file](#) on page 281.

5 Rotation pattern file...

This control opens the file dialog to select a rotation pattern file.

NOTE

For details about the supported file format see [Phase Noise / IQ rotator pattern file](#) on page 281.

Polarization

Theory

Throughout this document we use the terms State of Polarization (SOP), Poincaré sphere, Stokes space, Jones Matrix, waveplate, depolarization. For a detailed description of these terms see, e.g., reference [6].

As illustrated in the section **Real-time DSP Engine** on page 27, there are two polarization controller stages in the DSP block of the M8195A hardware, one in front of the PMD block and a second one after the PMD block.

There are two modes that the polarization controllers may be operated in:

- Basic (Waveplate / Pattern) mode
- Advanced (Jones Matrices) mode

In Basic mode, each of the polarization controller stages is addressed as a sequence of a rotator (circular retarder) and a linear retarder. With the PMD emulator stage disabled, both sections are addressed as a single polarization controller, namely this sequence of elements: rotator, retarder, rotator, retarder.

Static rotation/retardation angles can be provided as well as sequences (patterns), which are then cycled through at a given advance rate.

In Advanced mode, no sequences (patterns) are supported, but also there is no limitation with respect to the type of polarization-affecting element to be emulated, as long as it is in no way depolarizing. Thus, an arbitrary Jones matrix can be defined for each of the polarization controller stages.

Continuous Patterns

There are several aspects to be considered when using polarization controller patterns:

- For visualizing the polarization pattern, a trajectory is shown on the Poincaré sphere in Stokes space. This trajectory does not fully characterize the polarization pattern, but its effect on a single input polarization (reference polarization). This reference polarization is chosen to be the transmitter X-polarization. The transmitter Y-polarization will move on a similar trajectory.

If a Great Circle pattern is chosen, the trajectory will cover the equatorial plain in Stokes space. Thus, the resulting electrical signal will start with X and Y transmission signals on their respective channel pairs, then evolve through states where X and Y transmitter signals

contribute to both channel pairs and eventually lead to a signal swap (transmitter X signal on Y channel pair and vice versa). This evolution will continue until the transmitter X signal is back on the X channel pair.

NOTE

This visualization always uses ideal transmitter X-polarization as reference, even if a preceding polarization controller or PMD emulator stage would have affected the actual state of polarization of the signal.

- As described in section [Clock Cycles in Real-time Mode](#) on page 37, each polarization pattern step is applied for integer multiples of 128 samples / symbols. This means that even for an apparently continuous pattern, there will be distinct steps in the resulting polarization. The pattern length should be chosen high enough to make for sufficiently small polarization steps, such that they can be assumed continuous with respect to your application or algorithm to be tested.
- All polarization pattern modes support polarization rotation patterns of length 10,000.

The polarization pattern advance rate f_a can be chosen in the following range:

$$f_a = \text{Sampling Rate} / 128 / N \text{ with } N = 1 \dots 262144$$

$$\text{Example (at 64GSa/s): } f_a = 1.9\text{kHz} \dots 500\text{MHz}$$

- For convenience an equivalent speed setting is used in the GUI with 1 indicating maximum rotation rate, 0 indicating minimum rotation rate and a basically linear behavior, i.e., 0.5 indicating half the maximum rotation rate. Due to the integer division nature of the advance rate implementation there is no valid setting between maximum rate (speed 1) and half that rate (speed 0.5), between speed 0.5 and speed 0.333 or between any other integer fractions
- In principle, each polarization controller stage (one rotator, one retarder) can be used to transform any linear input state of polarization (SOP), to any output SOP. Usually this means transforming the static transmitter X- or Y-state to some kind of SOP trajectory. The polarization pattern contains a list of up to 10,000 user-defined polarization rotation settings. However for smoothest transitions regarding residual IQ phase during SOP rotation, as well as for endless polarization avoiding undesired 180° changes in IQ-phase, both polarization controller stages should be used in a combined manner, requiring the PMD stage to be inactive.

This is the reason why the lists of predefined patterns on the polarization controller tab has less (and different) entries with an active PMD stage than with an inactive PMD stage.

NOTE

When working in waveform mode two important aspects need to be considered. They arise from the fact that the polarization pattern length and its playback speed are explicitly configured. Therefore, the polarization pattern playtime most likely does not match the data pattern length (the master setting for the waveform pattern length to be uploaded). This means that the polarization change within the uploaded waveform will only describe a continuous SOP trajectory, if the settings are manually matched appropriately. Furthermore, for symbol patterns too short relative to the polarization pattern, only a small portion of the desired polarization pattern may actually be included in the waveform data. This short trajectory will then repeat with the symbol pattern and may even appear as no polarization change at all. To avoid that, either select a longer PRBS or manually increase the number of samples on the Waveform input tab.

Great Circle Mode

When using Great-Circle mode, the software will automatically compute the required pattern of polarization controller settings that create the desired SOP rotation pattern, based on user-defined parameters, such as speed and step size / pattern length.

In Great Circle mode, the ideal transmitter X polarization state is rotated on the equatorial plain of the Poincaré sphere at a constant SOP rate of change.

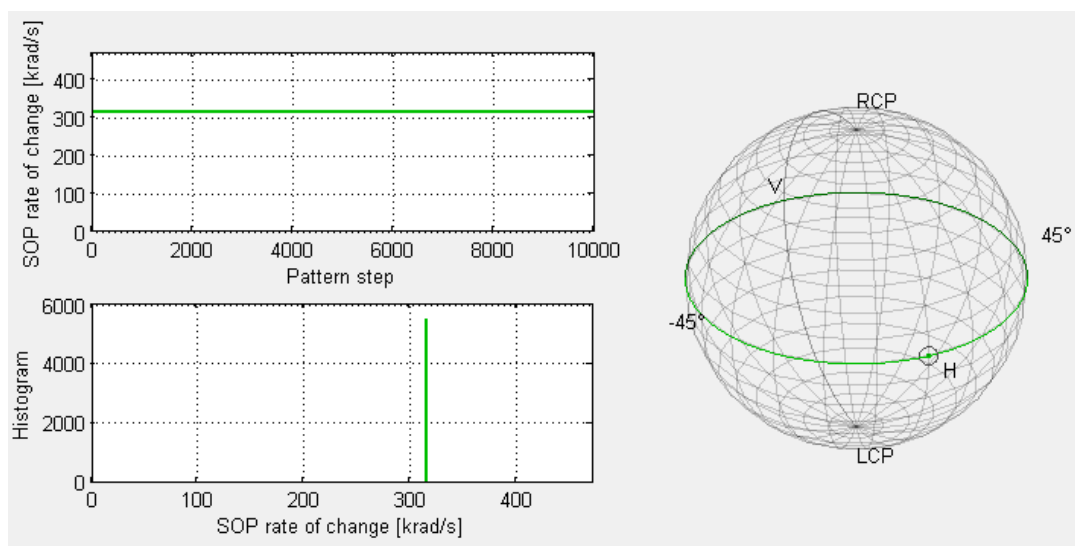

Figure 39 Illustration of Great Circle pattern mode

The Great-Circle Mode basically covers SOP rates between 2.4 rad/s and more than 175 Mrad/s (see [Table 9](#) on page 124). The SOP rate is defined by the pattern length as well as the pattern advance rate. Therefore, a broad range of these SOP rates can be achieved by different combinations of these two parameters. In consequence, it is important to choose the pattern length / step size first, such that the resulting SOP step can be tolerated by the receiver system, as if it were a continuously changing trajectory instead of a stepped one.

[Table 9](#) on page 124 shows SOP step sizes as well as corresponding minimum and maximum SOP rates for a few pattern length settings.

Table 9 Speed characteristics overview for Great Circle pattern mode

Pattern Length	10,000 (max)	3600	360	36
SOP Step Size	0.07°	0.2°	2°	20°
Lowest possible SOP-Rate (at 64GSa/s)	2.4 rad/s	6.6 rad/s	67 rad / s	666 rad/s
Highest possible SOP-Rate (at 64GSa/s)	628 krad/s	1.75 Mrad/s	17.5 Mrad/s	175 Mrad/s

Spinning Coin Mode

The predefined Spinning Coin mode requires all four polarization controller stages, so it may not be used when PMD emulation is active as well.

Spinning Coin mode is basically an extension to Great Circle mode such that the SOP is quickly rotating on a circle, while that circle is slowly rotating around the Poincaré sphere.

This way, the Poincaré sphere may be covered while keeping a constant SOP rate of change.

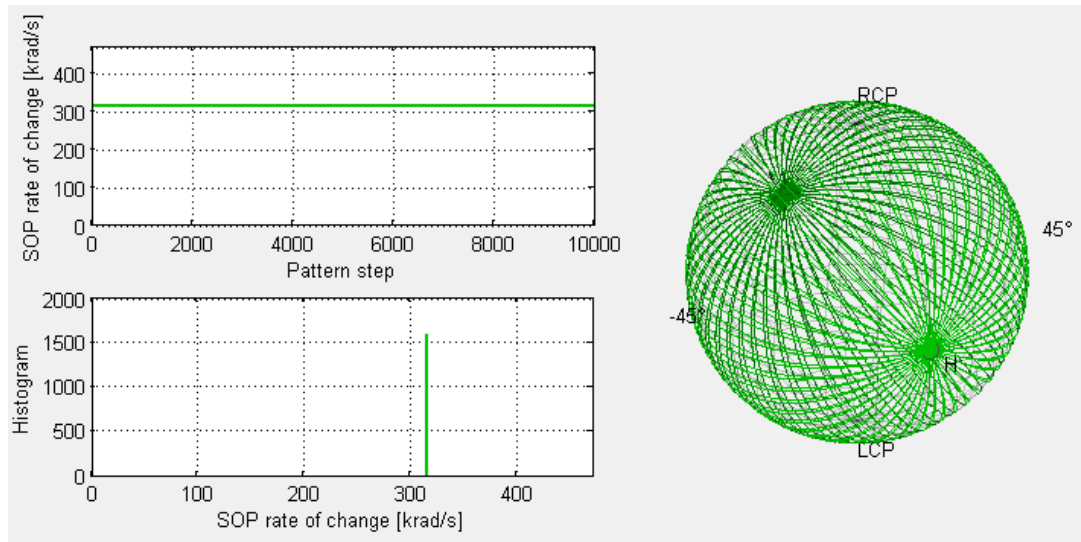

Figure 40 Illustration of Spinning Coin pattern mode

Sphere coverage is influenced by the Ratio parameter, while SOP rate is defined by the SOP step size in conjunction with the speed setting.

It is important to choose the pattern length / SOP step size first, such that the resulting SOP step can be tolerated by the receiver system, as if it were a continuously changing trajectory instead of a stepped one.

Table 10 on page 125 shows achievable SOP rates for reasonable values for Ratio and SOP Step Size assuming maximum pattern length (10,000). For a given Ratio value, reducing the pattern length will proportionally increase SOP step size and SOP rates.

Table 10 Speed characteristics overview for Spinning Coin pattern mode

Ratio	0.25		0.5		0.75	
SOP Step Size	0.94°		1.87°		2.74°	
	Min. Speed	Max. Speed	Min. Speed	Max. Speed	Min. Speed	Max. Speed
SOP-Rate* [rad/s]	31.3	8.2 M	62.3	16.3 M	91	23.9 M
Pattern Duration* [s]	5.2	20 u	5.2	20 u	5.2	20 u
Pattern Rep. Rate* [Hz]	0.2	50 k	0.2	50 k	0.2	50 k

*: at 64 GSa/s

Slicer Mode

The predefined Slicer mode requires all four polarization controller stages, so it may not be used when PMD emulation is active as well.

In Slicer mode, the SOP trajectory is generated by a rotation of the SOP around the X/Y-Stokes axis at a given, static rotation rate and a superimposed rotation around the Circular-Stokes axis at a given static, lower, rotation rate.

This way, a certain sphere coverage can be reached with a broad distribution of SOP rate of change, namely low rate of change near the X and Y polarization states, and highest rate of change on the great circle through the +/- 45 degree and the circular states.

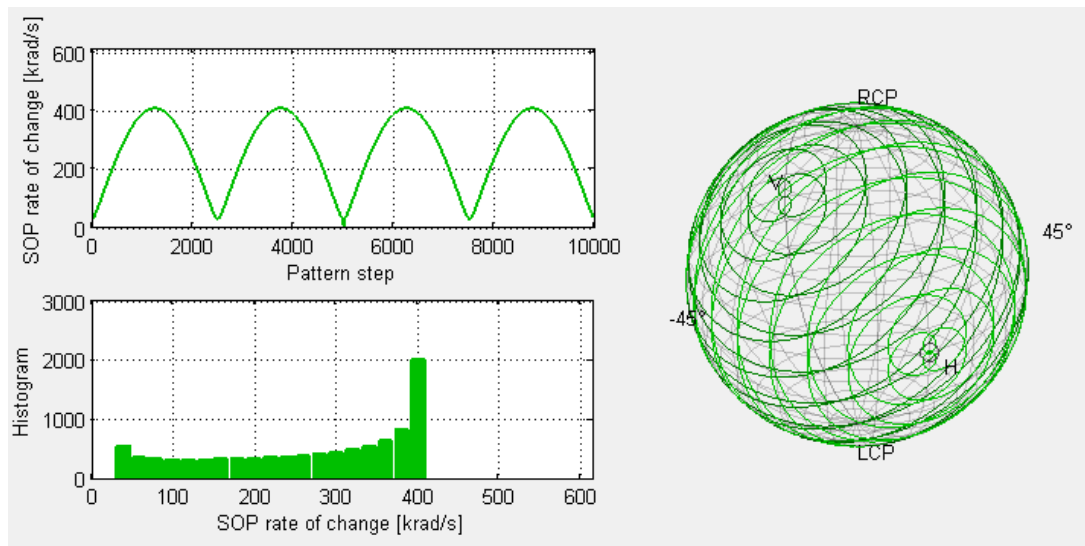

Figure 41 Illustration of Slicer pattern mode

Sphere coverage is influenced by the Ratio parameter, while SOP rate is defined by the SOP step size in conjunction with the speed setting.

It is important to choose the pattern length / SOP step size first, such that the resulting SOP step can be tolerated by the receiver system, as if it were a continuously changing trajectory instead of a stepped one.

Table 11 on page 126 shows achievable SOP rates for reasonable values for Ratio and SOP Step Size assuming maximum pattern length (10,000). For a given Ratio value, reducing the pattern length will proportionally increase SOP step size and SOP rates.

Table 11 Speed characteristics overview for Slicer pattern mode

Ratio	0.25	0.5	0.75			
SOP Step Size	0.47°	0.94°	1.4°			
	Min. Speed	Max. Speed	Min. Speed	Max. Speed	Min. Speed	Max. Speed

Average SOP-Rate* [rad/s]	10.4	2.7 M	20.1	5.3 M	29.2	7.65 M
Maximum SOP-Rate* [rad/s]	15.8	4.1 M	31.3	8.2 M	45.6	11.95 M
Pattern Duration* [s]	5.2	20 u	5.2	20 u	5.2	20 u
Pattern Rep. Rate* [Hz]	0.2	50 k	0.2	50 k	0.2	50 k

*: at 64GSa/s

Polarization Tab

This tab is used to set polarization properties of the generated signals.

NOTE

This tab requires the 81195A-OSP option, so it will be disabled without a valid 81195A-OSP license being installed.

There are two basic modes of operation and an additional mode toggle, which are selected through these controls:

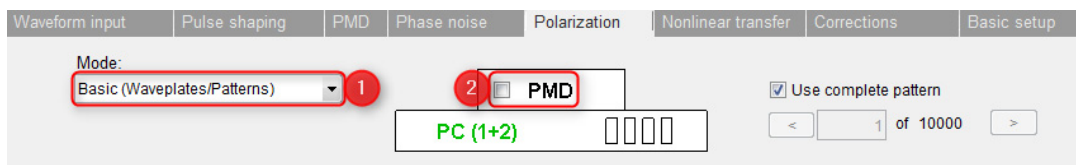

Figure 42 Polarization tab

1 Mode of operation

In Basic (*Waveplates / Patterns*) mode, the polarization controller stage is addressed as two pairs of one circular and one linear retarder each, all of them with fixed orientation and adjustable retardation, as explained in section [Theory](#) on page 120. They are controlled by setting

retardation values for the specific stages. In Basic mode, either complete polarization patterns can be applied to the signals, as well as single steps from the pattern.

In Advanced (Jones–Matrices) mode, the polarization controller stage is addressed as two complex Jones matrices, allowing emulation of more complex polarization-affecting elements, but not allowing patterns / sequences.

Available Settings:

- Basic (Waveplates / Patterns)
- Advanced (Jones–Matrices)

2 Toggle PMD stage

This control toggles the PMD stage of the optical signal properties generation. As explained in section [Theory](#) on page 120, the polarization controller is acting as a combined four-stage controller if PMD is disabled or as two-stage controllers, if PMD is enabled.

NOTE

If set, this control will uncheck the Bypass PMD block control on the PMD tab and vice versa.

Depending on the combination of the above controls, there will be a different control layout. Use this matrix to access the appropriate user's guide section:

Table 12 User's Guide section overview based on basic polarization settings

	PMD off	PMD on
Basic mode (Waveplates and patterns)	Polarization (Basic (Waveplate / Patterns) mode without PMD) on page 129	Polarization (Basic (Waveplate / Patterns) mode with PMD) on page 134
Advanced mode (Jones matrices)	Polarization (Advanced (Jones-Matrices) mode without PMD) on page 137	Polarization (Advanced (Jones-Matrices) mode with PMD) on page 139

Polarization (Basic (Waveplate / Patterns) mode without PMD)

In this mode, there are two separate polarization controller stages, but they are assumed to be arranged in direct sequence. See section [Theory](#) on page 98 for further details.

The Polarization tab comprises a number of controls, which are explained in detail in the [Figure 43](#) on page 129.

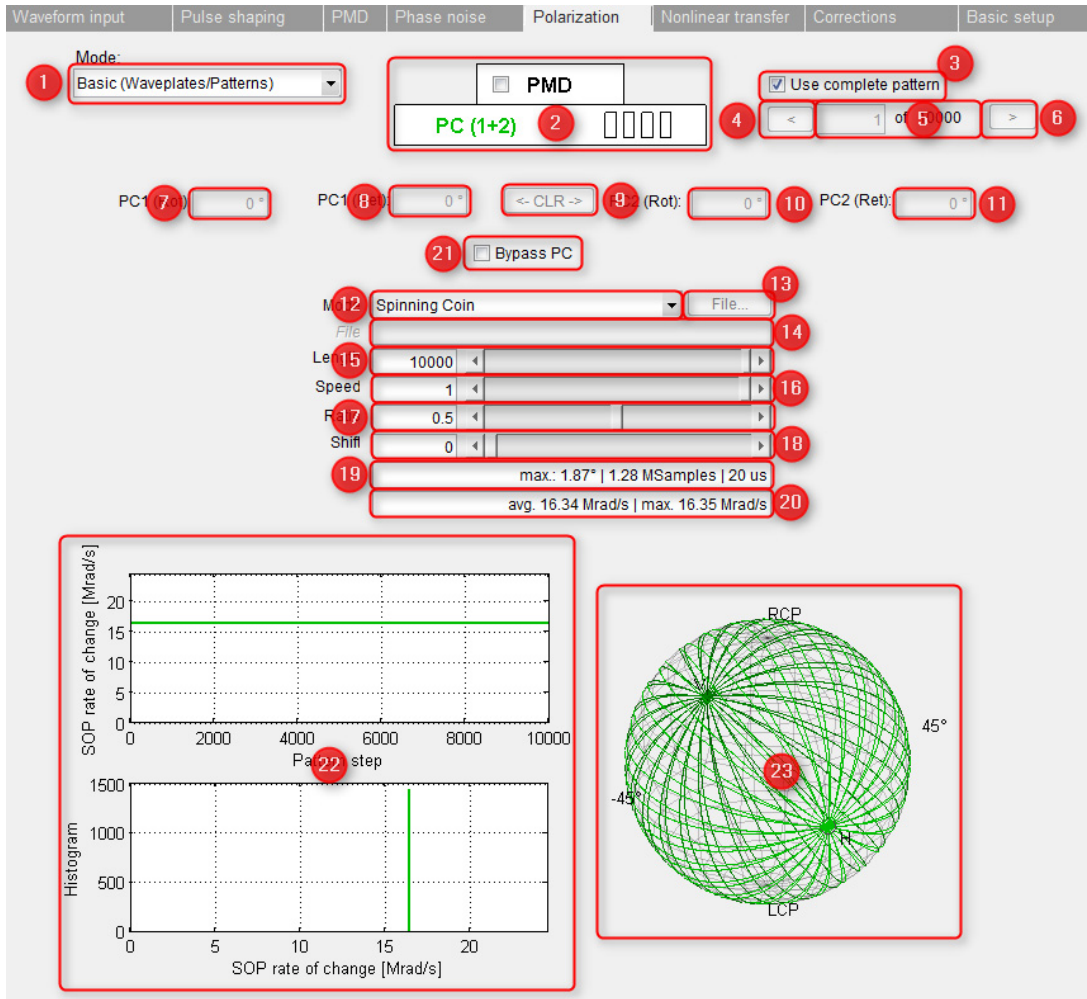

Figure 43 Polarization tab (Basic mode without PMD)

1 Mode of Operation

This control is explained in section **Mode of operation** on page 127.

2 PMD

This control is explained in section **Toggle PMD stage** on page 128.

3 Use complete pattern

If this control is set, the whole polarization pattern is applied to the signal. Otherwise only a single pattern step is applied and kept.

NOTE

When operating in *Waveform* mode, you should make sure that the pattern length is a multiple of the number of clock cycles of the signal (see section [This control displays the clock cycle length of the current waveform \(in multiple of the minimum waveform size of 128\) samples.](#) on page 84). Otherwise there will be a non-continuous transition within the generated signal.

4 Previous pattern step

When *Use complete pattern* is unchecked, this button allows stepping through the pattern downwards. The step size is one percent of the pattern length

5 Set pattern step

When *Use complete pattern* is unchecked, this control is used to activate a specific pattern step

6 Next pattern step

When *Use complete pattern* is unchecked, this button allows stepping through the pattern upwards. The step size is one percent of the pattern length

7 Retardation of first rotator (circular retarder)

When *Use complete pattern* is unchecked, this control allows setting the rotation angle of the first polarization controller stage in degrees.

Allowed Range:0°...180°

8 Retardation of first retarder (linear retarder)

When *Use complete pattern* is unchecked, this control allows setting the retardation angle of the first polarization controller stage in degrees.

Allowed Range:0°...360°

9 Clear rotator / retarder angles

When *Use complete pattern* is unchecked, this control is used to set all Rotation / Retardation controls to 0°

10 Retardation of second rotator (circular retarder)

When *Use complete pattern* is unchecked, this control allows setting the rotation angle of the second polarization controller stage in degrees.

Allowed Range:0°...180°

11 Retardation of second retarder (linear retarder)

When *Use complete pattern* is unchecked, this control allows setting the retardation angle of the second polarization controller stage in degrees.

Allowed Range:0°...360°

12 Pattern Mode

This control allows selection of the pattern to be used.

Available Settings:

- User Defined
- Great Circle
- Spinning Coin
- Slicer

13 File...

When *Pattern Mode* is set to User Defined, this control becomes enabled and will open a dialog for selecting a pattern file.

See section [Polarization Controller pattern file](#) on page 282 for details on the file format.

14 File name

When Pattern Mode is set to User Defined, this control becomes enabled and can be used to enter a pattern file name directly. Alternatively it will show the name of the file selected by clicking the File... button.

See section [Phase Noise / IQ rotator pattern file](#) on page 281 for details on the file format.

15 Pattern Length

This control defines the length of the polarization pattern.

In general, for a given Pattern Mode, larger Pattern Length means smaller polarization steps and slower advance rates / longer play times. See section [Theory](#) on page 98 for further details.

Allowed Range:1...10000 (steps)

NOTE

Pattern Length cannot be modified if User Defined Pattern Mode is used.

16 Pattern Speed

This control defines the speed of the polarization pattern.

When this is set to one, the polarization pattern will advance at the highest rate possible. When set to zero, it will advance at the slowest rate possible. See section [Theory](#) on page 98 for further details.

Allowed Range:0...1

NOTE

Requires Use complete pattern to be checked to have any effect.

NOTE

Although the range of this setting is 0 to 1, not all settings are valid. See section [Theory](#) on page 120 for details.

17 Pattern Ratio

This control defines a ratio value for certain Pattern Modes.

Pattern Modes such as Slicer and Spinning Coin basically combine two SOP rotations around different axes in Stokes space. The relative rotation speed between both rotations is controlled by this setting. See section [Theory](#) on page 98 for further details.

Allowed Range:0...1

NOTE

This control is only enabled for certain modes such as Slicer or Spinning Coin.

18 Pattern Shift

This control defines a pattern offset.

When set to zero, the default pattern will be used. By increasing this value, the start position is shifted relatively to the total pattern length, so that when set to one, the original pattern start is reached once again.

Allowed Range:0...1

19 Polarization Info Block 1

This indicator shows

- the maximum SOP step to be expected when applying the selected polarization pattern
- the pattern duration in samples
- the total play time of the pattern

See section [Theory](#) on page 98 for further details.

20 Polarization Info Block 2

This indicator shows

- the average SOP rate of change to be expected when applying the selected polarization pattern
- the maximum SOP rate of change to be expected when applying the selected polarization pattern

See section [Theory](#) on page 98 for further details.

21 Bypass Polarization Controller

This control toggles the polarization controller on and off.

NOTE

When using real-time mode, the bypass checkbox can be used to start stop pattern playback. However, even with bypass unchecked, the DSP stage may be configured to wait for a trigger condition (see section [Input and Output Triggers](#) on page 29).

22 Polarization Speed Characteristics

The upper graph shows the SOP rate of change of the selected polarization pattern as a function of the pattern step. Transmitter X-polarization is considered as input SOP for this analysis.

The lower graph shows a histogram of the SOP rate of change of the selected polarization pattern. Transmitter X-polarization is considered as input SOP for this analysis.

23 Polarization Pattern Trajectory

This graph shows the SOP trajectory of the selected polarization pattern in Stokes space. Transmitter X-polarization is considered as input SOP for this analysis.

Polarization (Basic (Waveplate / Patterns) mode with PMD)

In this mode, there are two separate polarization controller stages. One is in front of the PMD stage, one after the PMD stage. See section [Theory](#) on page 98 for further details.

The Polarization tab comprises a number of controls, which are explained in detail in the [Figure 44](#) on page 134.

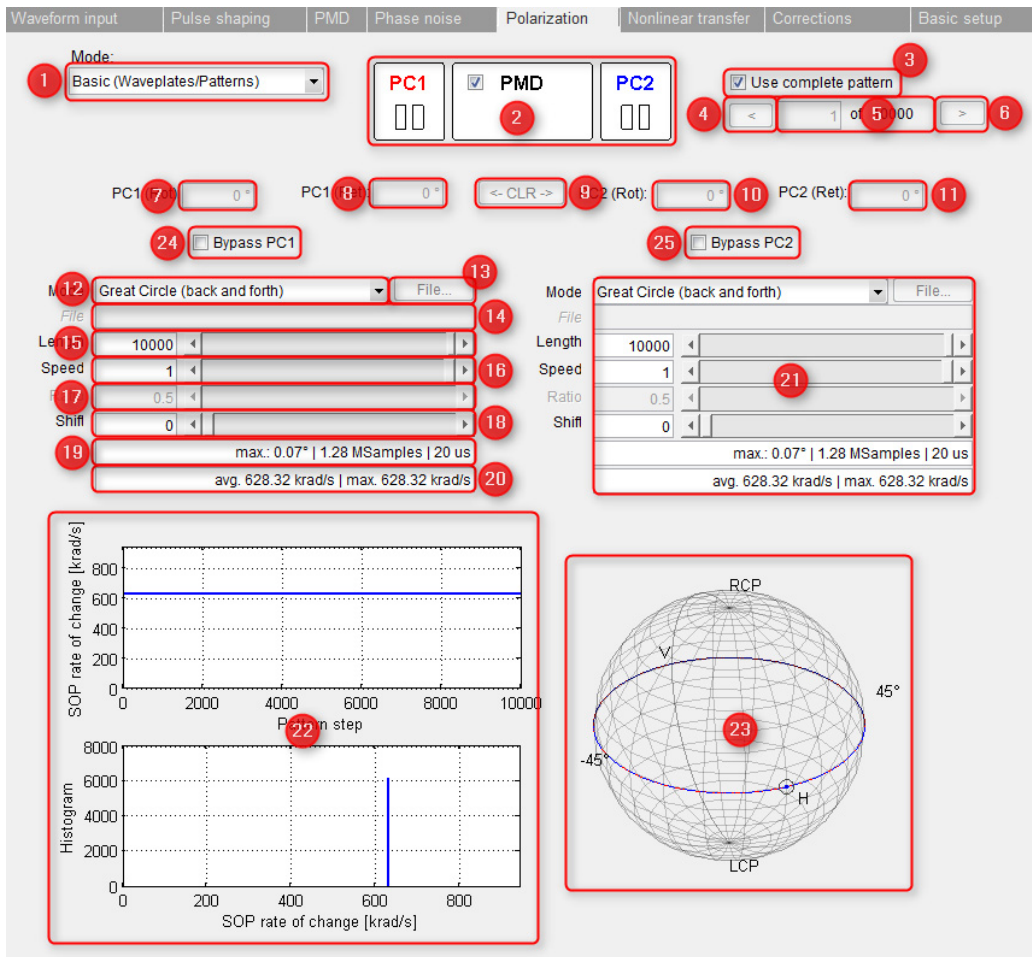

Figure 44 Polarization tab (Basic mode with PMD)

1 Mode of Operation

This control is explained in section **Mode of operation** on page 127.

2 PMD

This control is explained in section **Toggle PMD stage** on page 128.

3 Use complete pattern

This control is explained in section **Use complete pattern** on page 130.

4 Previous pattern step

This control is explained in section **Previous pattern step** on page 130.

5 Set pattern step

This control is explained in section **Set pattern step** on page 130.

6 Next pattern step

This control is explained in section **Next pattern step** on page 130.

7 Retardation of first rotator (circular retarder)

This control is explained in section **Retardation of first rotator (circular retarder)** on page 130.

8 Retardation of first retarder (linear retarder)

This control is explained in section **Retardation of first retarder (linear retarder)** on page 130.

9 Clear rotator / retarder angles

This control is explained in section **Clear rotator / retarder angles** on page 131.

10 Retardation of second rotator (circular retarder)

This control is explained in section **Retardation of second rotator (circular retarder)** on page 131.

11 Retardation of second retarder (linear retarder)

This control is explained in section **Retardation of second retarder (linear retarder)** on page 131.

12 Pattern Mode

This control allows selection of the pattern to be used.

Available Settings:

- User Defined
- Great Circle (back and forth)

NOTE

With PMD stage active, each polarization controller stage comprises only a single rotator and a single retarder, leading to a reduced set of available patterns. See section [Theory](#) on page 103 for further details.

13 File...

This control is explained in section [File...](#) on page 131.

14 File name

This control is explained in section [File name](#) on page 131.

15 Pattern Length

This control is explained in section [Pattern Length](#) on page 131.

16 Pattern Speed

This control is explained in section [Pattern Speed](#) on page 132.

17 Pattern Ratio

This control is explained in section [Pattern Ratio](#) on page 132.

18 Pattern Shift

This control is explained in section [Pattern Shift](#) on page 132.

19 Polarization Info Block 1

This control is explained in section [Polarization Info Block 1](#) on page 133.

20 Polarization Info Block 2

This control is explained in section [Polarization Info Block 2](#) on page 133.

21 Controls for Second Polarization Controller Stage

This group of controls is identical to controls 12 to 20, but applies to the second polarization controller stage instead.

22 Polarization Speed Characteristics

The upper graph shows the SOP rate of change of the selected polarization pattern(s) as a function of the pattern step. Transmitter X-polarization is considered as input SOP for this analysis.

The lower graph shows a histogram of the SOP rate of change of the selected polarization pattern(s). Transmitter X-polarization is considered as input SOP for this analysis.

23 Polarization Pattern Trajectory

This graph shows the SOP trajectory of the selected polarization pattern(s) in Stokes. Transmitter X-polarization is considered as input SOP for this analysis.

24 Bypass Polarization Controller 1

This control toggles the first polarization controller stage on and off.

NOTE

When using real-time mode, the bypass check box can be used to start stop pattern playback. However, even with bypass unchecked, the DSP stage may be configured to wait for a trigger condition (see section [Input and Output Triggers](#) on page 29).

25 Bypass Polarization Controller2

This control toggles the second polarization controller stage on and off.

NOTE

When using real-time mode, the bypass checkbox can be used to start stop pattern playback. However, even with bypass unchecked, the DSP stage may be configured to wait for a trigger condition (see section [Input and Output Triggers](#) on page 29).

Polarization (Advanced (Jones-Matrices) mode without PMD)

In this mode, there are two separate polarization controller stages, but they are assumed to be arranged in direct sequence. See section [Theory](#) on page 120 for further details.

The Polarization tab comprises a number of controls, which are explained in detail in the [Figure 45](#) on page 138.

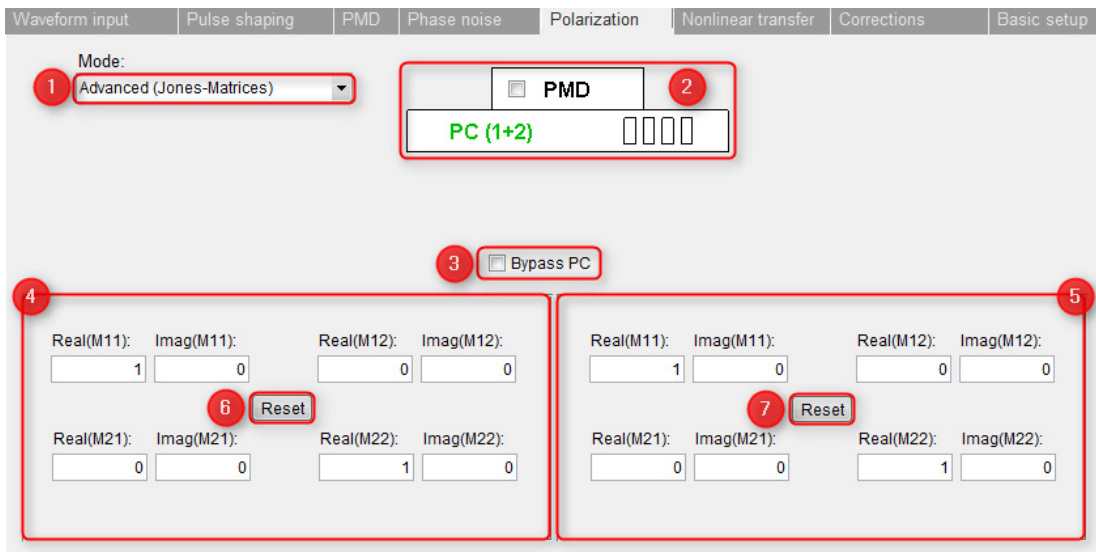

Figure 45 Polarization tab (Advanced mode without PMD)

1 Mode of Operation

This control is explained in section **Mode of operation** on page 127.

2 PMD

This control is explained in section **Toggle PMD stage** on page 128.

3 Bypass Polarization Controller

This control is explained in section **Bypass Polarization Controller** on page 133.

4 Jones Matrix Elements of first Polarization Controller stage

These controls define the real and imaginary parts of the four Jones matrix elements of the first polarization controller stage.

Allowed Range: -1...+1

5 Jones Matrix Elements of second Polarization Controller stage

These controls define the real and imaginary parts of the four Jones matrix elements of the second polarization controller stage.

Allowed Range: -1...+1

6 Reset Jones Matrix elements of first Polarization Controller stage

This control resets the Jones matrix of the first polarization controller stage to the Identity matrix.

7 Reset Jones Matrix elements of second Polarization Controller stage

This control resets the Jones matrix of the second polarization controller stage to the Identity matrix.

Polarization (Advanced (Jones-Matrices) mode with PMD)

In this mode, there are two separate polarization controller stages. One is in front of the PMD stage, one after the PMD stage. See section [Theory](#) on page 120 for further details.

The Polarization tab comprises a number of controls, which are explained in detail in the [Figure 46](#) on page 139.

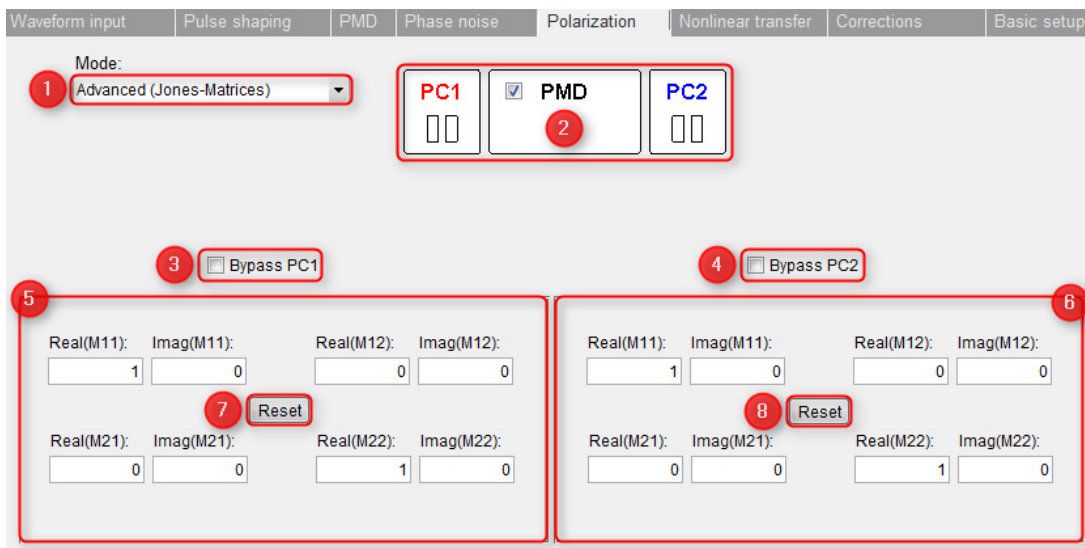

Figure 46 Polarization tab (Advanced mode with PMD)

1 Mode of Operation

This control is explained in section [Mode of operation](#) on page 127.

2 PMD

This control is explained in section [Toggle PMD stage](#) on page 128.

3 Bypass Polarization Controller 1

This control is explained in section **Bypass Polarization Controller** on page 133.

4 Bypass Polarization Controller 2

This control is explained in section **Polarization Info Block 2** on page 133.

5 Jones Matrix Elements of first Polarization Controller stage

These controls are defined in section **Jones Matrix Elements of first Polarization Controller stage** on page 138.

6 Jones Matrix Elements of second Polarization Controller stage

These controls are defined in section **Jones Matrix Elements of second Polarization Controller stage** on page 138.

7 Reset Jones Matrix elements of first Polarization Controller stage

This control is explained in section **Reset Jones Matrix elements of first Polarization Controller stage** on page 138.

8 Reset Jones Matrix elements of second Polarization Controller stage

This control is explained in section **Reset Jones Matrix elements of second Polarization Controller stage** on page 139.

Nonlinear Transfer Characteristics

Theory

To convert an electrical RF baseband signal from an AWG into a complex modulated optical signal, used in optical communication systems, an electro-optical modulator (EOM) is used which converts the electrical signal amplitudes into an intensity modulation of the input CW laser source (e.g. [7]). One type of electro-optic modulators commonly used in optical communication systems is a Mach-Zehnder intensity modulator (MZM).

These MZ modulators have a nonlinear transfer function which can be described by the following equation with

- P_{out} = Optical output power, P_{in} = Optical input power, V_a = Applied driving voltage and
- V_{π} = Half-wave voltage, ϕ = Bias offset

being the design parameters of the used modulator

$$P_{out}(t) = \frac{1}{2} P_{in} \left[1 - \cos \left(\frac{\pi}{V_{\pi}} V_a(t) + \phi \right) \right]$$

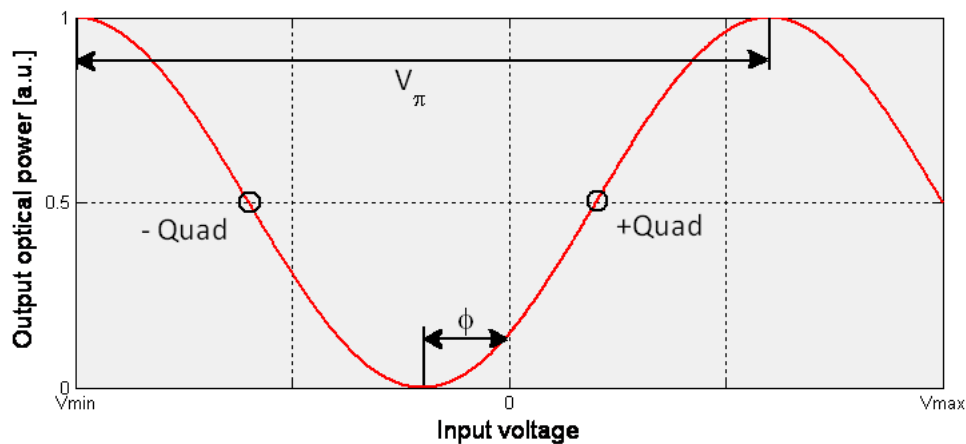

Figure 47 E/O modulator transfer function

The best linear transfer characteristic is evidently obtained at its quadrature points (-Quad, +Quad), therefore a modulator bias controller would ideally drive the modulator into one of these bias points.

To further linearize the E/O transfer characteristic and account for the sinusoidal shape of the modulator transfer function one must pre-distort the electrical input signal by applying the inverse function.

Nonlinear Transfer Characteristics

The nonlinear equalizer available in the M8195A real-time processing block can be used to compensate for other nonlinear transfer characteristics in the signal path, as for example an electro-optical modulator.

Its transfer function is based on a broken line approximation with 16 segments in total. You can select per channel from 3 pre-defined transfer functions or provide a user-defined transfer function file.

The transfer functions are always defined in a normalized input range of -1 to 1 which typically corresponds to half of the Voltage $V\pi$ (see Figure 47 on page 141). If you want to use a smaller input range of the defined transfer function (e.g. when reducing the driving voltage amplitude) you can specify the new input range with respect to the full range. Please note that the reduced range of this new transfer function will be again normalized and displayed in the range from -1 to 1 for input and output automatically (see Figure 48 on page 142).

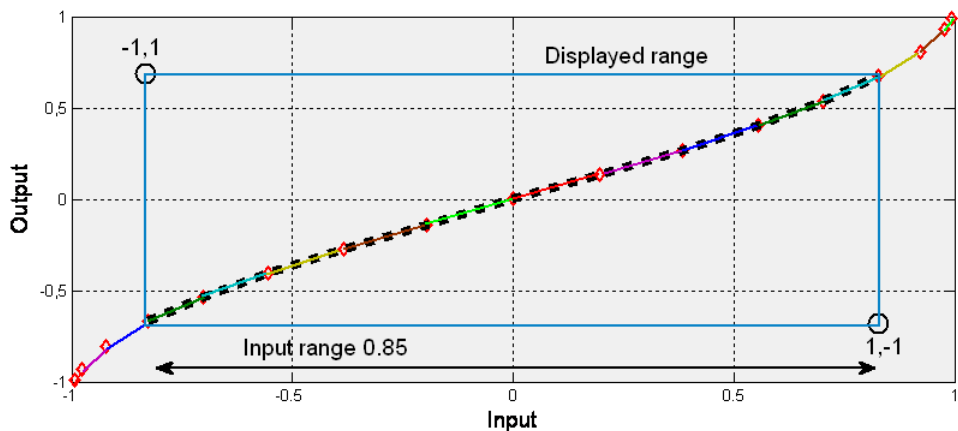

Figure 48 Non-linear transfer function using an arcsine as example

NOTE

This tab requires the 81195A-OSP option, so it will be disabled without a valid 81195A-OSP license being installed.

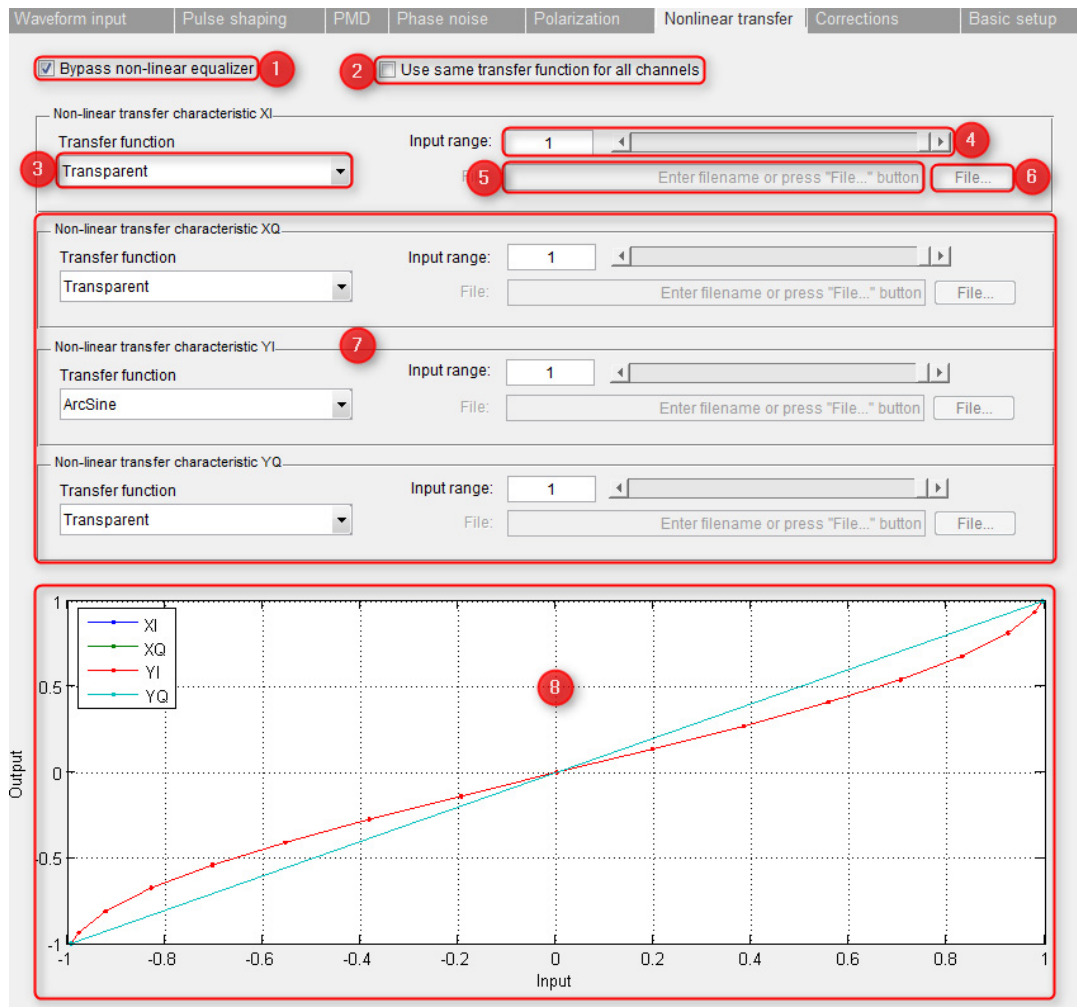

Figure 49 Nonlinear Transfer tab

1 Bypass non-linear equalizer

This check box enables or bypasses the non-linear equalizer block in the signal generation path.

2 Use same transfer function on all channels

This check box enables or disables the controls for the channels XQ, YI and YQ. If the check box is set the same non-linear transfer function settings are used on all channels (default).

3 Transfer function

This drop down menu selects between three pre-defined transfer functions or loading a user defined transfer function file.

Available Settings:

- Transparent
- ArcSine
- Sine
- User defined

4 Input range

This control (either slider or numeric field) sets the used input range from the selected transfer function. For more detailed description see [Figure 48](#) on page 142: Non-linear transfer function using an arcsine as example.

Allowed Range:0...1

5 Transfer function filename

This field displays the currently selected or allows to directly set the user-defined transfer function file for the non-linear equalizer.

NOTE

For more details on this file format please see section [Nonlinear transfer characteristics file](#) on page 283.

NOTE

This mode requires the 81195A-OSP option / license.

6 Transfer function file...

This control opens the file dialog to select a user defined transfer function file

NOTE

For more details on this file format please see section [Nonlinear transfer characteristics file](#) on page 283.

NOTE

This mode requires the 81195A-OSP option / license.

7 Transfer function controls for other channels

This group of controls duplicates all controls from the XI channel non-linear transfer characteristic for the channels XQ, YI and YQ and is only active with disabled check box *Use same transfer function for all channels*.

8 Transfer function plot

This plot displays the transfer functions for all available channels.

NOTE

The displayed input and output range will always be normalized to -1..1

Corrections

Theory

The term “Corrections” collects a number of measures that can be taken to obtain an optimum signal quality at the AWG output ports or at certain reference planes using additional deembedding features. These corrections are then applied to the waveform using a per channel FIR filter.

The best signal performance is normally achieved with a flat frequency response (which respect to amplitude and phase) throughout the complete transmission path. However nearly every component on the path observes a frequency dependency and induces signal quality degradation. To compensate for this non-ideal frequency response you can e.g. apply the inverse characteristic to the original signal thus pre-distorting the original waveform.

The following example explains the calculation of a pre-distorted waveform applying a de-emphasis in more detail.

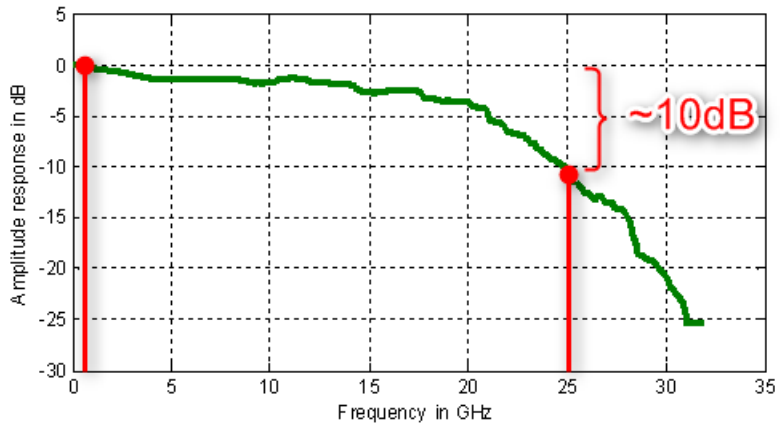

Figure 50 Exemplary frequency response

Figure 50 on page 146 shows an exemplary frequency response (shown here only the amplitude response) which observes a typical low-pass characteristic (e.g. high frequency components at 25GHz are attenuated by 10dB). To regain a flat frequency response one could either amplify the high frequencies or attenuate low frequencies, however since the AWG has a limited dynamic range one have to choose the latter one. Accordingly

Figure 51 on page 147 shows the flattened frequency response (blue and red dashed lines) applying a de-emphasis with different system bandwidth which is the frequency up to which the compensation is applied (i.e. flattened frequency response).

One can clearly see that using a very high system bandwidth might result in a strongly reduced dynamic range thus also reducing the signal's SNR. So finding the optimum signal performance is actually finding a tradeoff between the compensation parameters.

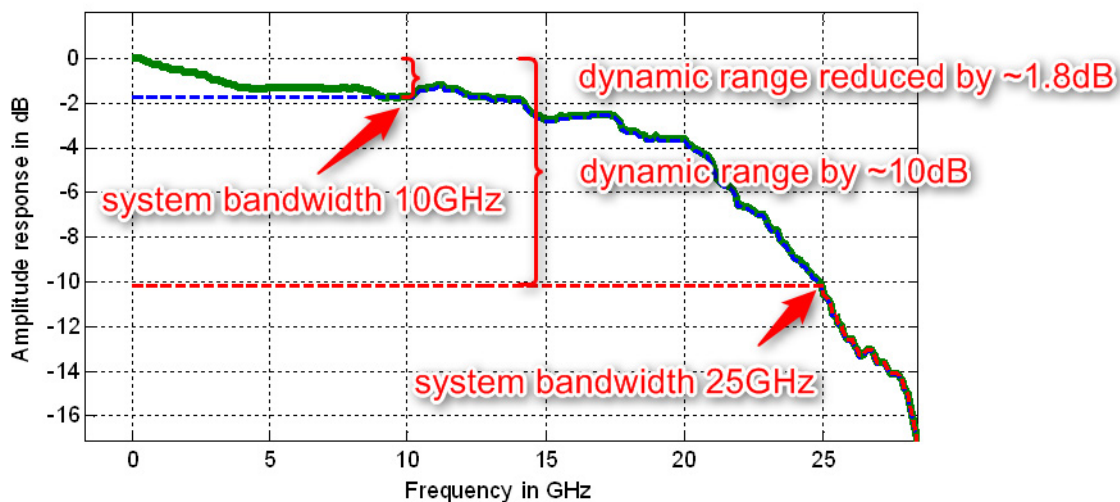

Figure 51 Flattened frequency response using de-emphasis

Corrections

Basically the different correction features are divided into two groups, a first group (*Magnitude and Phase Response*) which compensates the amplitude and phase response of different elements in the signal path and a second group containing *Skew and Gain Imbalance* correction which is virtually frequency independent.

With the correction FIR being active all enabled correction features will contribute to the calculation of a single compensation filter (per channel). Additionally the corresponding channel response will be displayed in a graph.

Some corrections are rather correlated to the corresponding data channels XI, XQ, YI, YQ than to the physical AWG output channels Ch1, Ch2, Ch3 and Ch4 (see [Table 13](#) on page 148). The detailed control description will explain how to use the correction parameters in each case.

Table 13 Overview of the available correction types and their relation to data or physical channels

Correction type	Correlated to physical AWG channels 1-4 (independent of channel mapping)	Correlated to data channels XI, XQ, YI, YQ
Build-in channel characteristic	X	
S-parameter deembedding	X	
Standard cable loss	X	
FIR coefficient files	X	
VSA equalization filter		X
Skew deembedding		X
Gain imbalance deembedding		X

NOTE

Corrections are only applied when sending data to an actual instrument. All settings on this tab are ignored when loading a waveform to VSA or saving a waveform to a file.

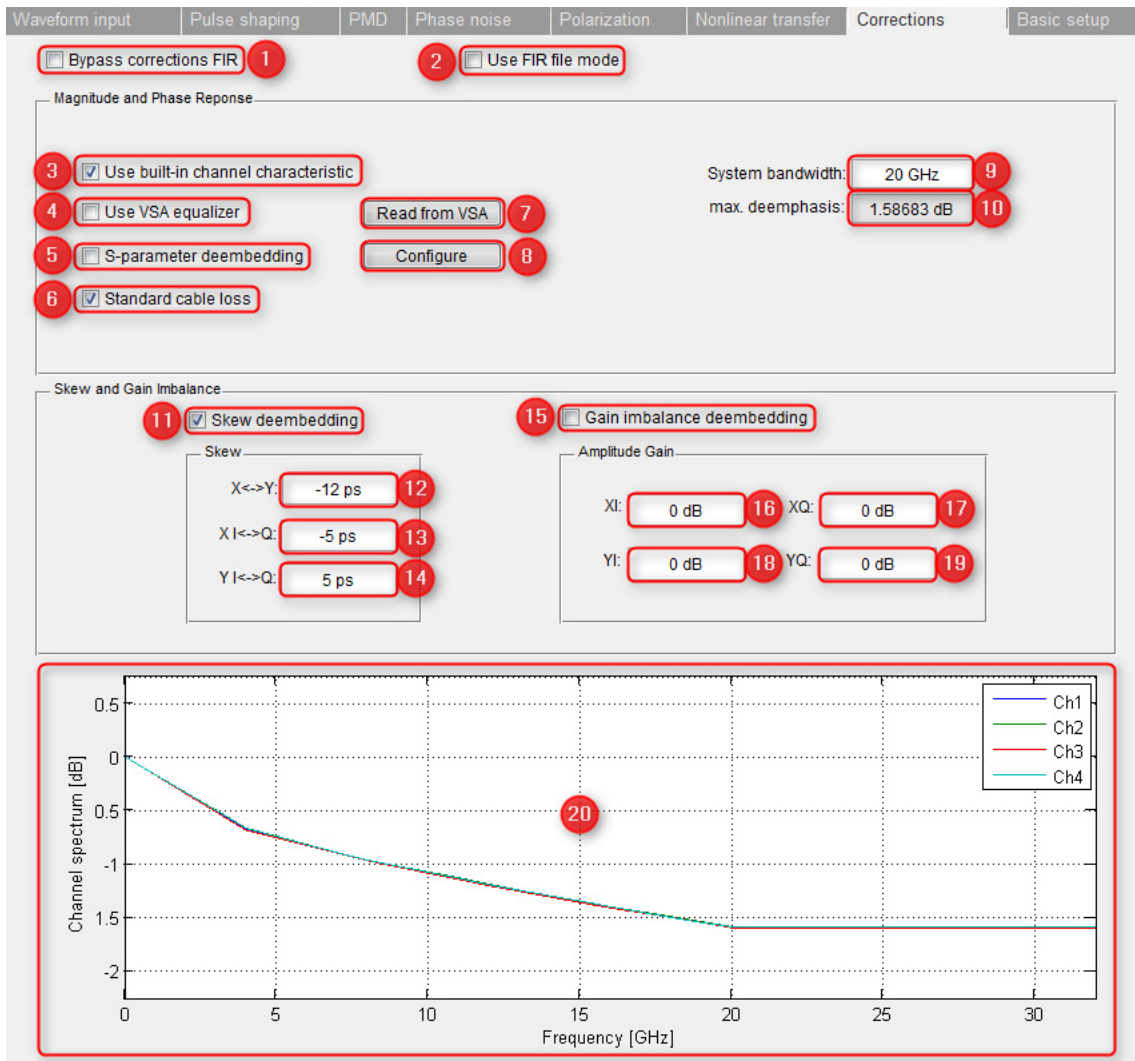

Figure 52 Corrections tab (Normal mode)

1 Bypass correction FIR

This check box enables or bypasses the correction filter block in the signal generation path.

2 Use FIR file mode

This check box enables the FIR file mode which allows to program user defined FIR filter coefficients. See [Corrections \(Use FIR file mode\)](#) on page 156 for more details.

3 Use built-in channel characteristic

This check box enables the usage of the AWG's built in frequency response calibration data for correction.

The AWG's built-in amplitude and phase response calibration can be used and applied to the calculated waveform to generate a clean signal at the output ports of the instrument. The built-in channel characteristic is directly linked to the AWGs physical channels.

4 Use VSA equalizer files

This check box enables the usage of VSA equalization filter files that have been previously read out from the VSA for compensation purpose. Note that these filters are directly correlated with the data channels.

The following files will be used by default for VSA equalization filter:

- EQFreqRespCH1.mat (for complex IQ pair 1)
- EQFreqRespCH2.mat (for complex IQ pair 2)

These will be taken from the default program data directory:

"C:\ProgramData\Keysight\Optical Modulation Generator\" (in Windows 7)

Alternatively, if you cannot connect to the VSA software via VISA, you can manually copy the VSA equalization filter file into the listed directory. To do this please perform the following steps:

- 1 Select respective traces "Channel Frequency Response" in VSA software
- 2 Go to: *File -> Save -> Save Trace...*
- 3 Specify respective file names (see above) (and optionally the target directory)
- 4 Enable check box "Save with header data"
- 5 Optionally: Manually copy saved files to listed target directory

5 S-parameter deembedding

This check box enables the usage of selected S-parameter files for correction. The S-parameter files are related to the physical AWG channels (CH1-Ch4).

To select S-parameter files for correction see [S-Parameter deembedding](#) on page 154.

6 Standard cable loss

This check box enables the usage of the pre-defined frequency response for the Keysight standard cables for correction. The standard cable loss correction is related to the physical AWG channels (CH1-Ch4).

Keysight part number:

M8195-810- Matched Cable Pair for M8195 AWG, 2.92 mm

7 Read-out equalization filter from VSA

Clicking this button reads out the currently used VSA equalization filters from the VSA software.

NOTE

This operation requires the equalization filter in the VSA to be active.

NOTE

This operation requires a valid VISA connection to the VISA software. To configure and check the VISA connection see **Test VSA connection** on page 59.

8 Configure S-parameter deembedding

This button opens the S-parameter dialog. For detailed description see [S-Parameter deembedding](#) on page 154.

9 System Bandwidth

This control sets the current system bandwidth. For definition and detailed explanation see [Theory](#) on page 146.

10 Max. deemphasis

This control displays the max. deemphasis value (in dB) occurred in the last waveform calculation.

11 Skew deembedding

This check box enables the skew correction using the current skew values for $X \langle \rangle Y$, $XI \langle \rangle XQ$ and $YI \langle \rangle YQ$.

The skew correction values can be either taken from the VSA Optical Signal Summary tab (only available with installed N4391A or N4392A Optical Modulation Analyzer extensions, see [Figure 53](#) on page 152) or by a manual measurement.

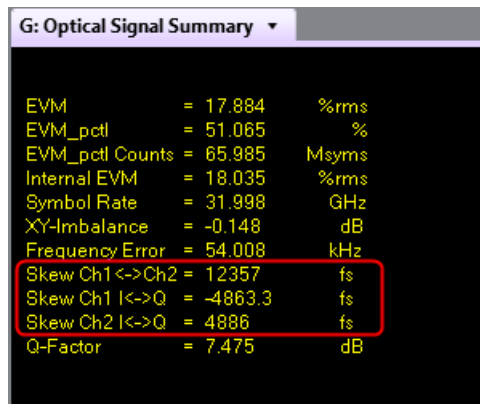

Figure 53 Skew measurement results in VSA

Definition of data channel skew values:

- Skew CH X<->CH Y:

Delay between complex data channels X and Y. A positive value depicts a lag of the Y channel with respect to the X channel.

- Skew CH XI<->XQ:

Delay between real valued data channel XI and XQ. A positive value depicts a lag of the XQ channel with respect to the XI channel.

- Skew CH YI<->YQ:

Delay between real valued data channels YI and YQ. A positive value depicts a lag of the YQ channel with respect to the YI channel.

The data channel related skew values for X<>Y, XI<>XQ and YI<>YQ can be converted to delays of the real physical channels using the current channel mapping table (see **Data channel mapping** on page 162) and the following definition (assuming the default mapping: XI->Ch1, XQ->Ch2, YI->Ch3 and YQ->Ch4).

$\text{Delay}_{\text{CH1}} = 0\text{s}$ (without loss of generality the first channel delay will be defined as reference with delay = 0s)

$\text{Delay}_{\text{CH2}} = \text{Skew}_{\text{XI<>XQ}}$

$\text{Delay}_{\text{CH3}} = \text{Skew}_{\text{X<>Y}} + \frac{1}{2} (\text{Skew}_{\text{XI<>XQ}} - \text{Skew}_{\text{YI<>YQ}})$

$\text{Delay}_{\text{CH4}} = \text{Skew}_{\text{X<>Y}} + \frac{1}{2} (\text{Skew}_{\text{XI<>XQ}} + \text{Skew}_{\text{YI<>YQ}})$

NOTE

If the IQ skew of a signal is close to one symbol period, a more or less reasonable constellation may appear. However, depending on the modulation format and the chosen PRBS, transmitted data and even the actual constellation may be severely impacted, e.g., causing additional constellation points in the corners of a QAM32 or lots of constellation points missing in a QAM64.

NOTE

One symbol shift -> Bad constellation / bit errors / unexpected PRBS corrections.

12 Skew between X/Y

This control sets the current skew between the X and Y channel pair

13 Skew between XI/XQ

This control sets the current skew between the complex XI and XQ pair

14 Skew between YI/YQ

This control sets the current skew between the complex YI and YQ pair

15 Gain imbalance deembedding

This check box enables the gain imbalance correction using the current amplitude gain values for XI, XQ, YI and YQ. The gain imbalance values are related to the corresponding data channels.

16 Amplitude gain XI

This control sets the current amplitude gain of data channel XI

17 Amplitude gain XQ

This control sets the current amplitude gain of data channel XQ

18 Amplitude gain YI

This control sets the current amplitude gain of data channel YI

19 Amplitude gain YQ

This control sets the current amplitude gain of data channel YQ

20 Correction filter spectrum

This plot shows the overall channel spectra that are used for calculation of the compensation filters for AWG channels CH1-Ch4.

NOTE

The graph shows the channels spectrum with full resolution that means the actually applied filter might have a different characteristic due to correction filter length restrictions (e.g. max. 16 filter taps in RT mode).

S-Parameter deembedding

This user interface opens up by clicking button **Configure S-parameter deembedding** on page 151 and allows selecting S-parameter files used for deembedding in the correction filter.

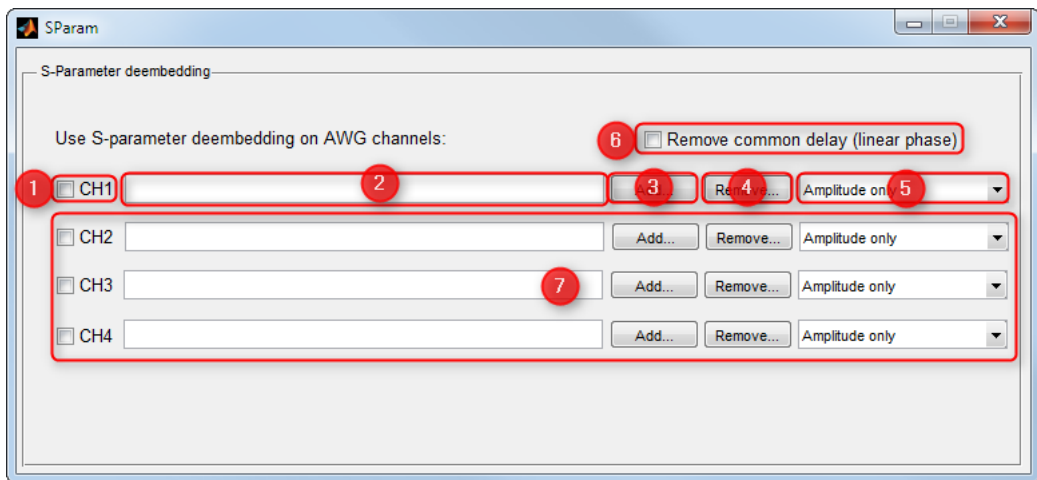

Figure 54 S-Parameter file dialog

1 Enable S-parameter deembedding (Channel 1)

This checkbox enables or disables the deembedding of channel 1 using the given list of S-parameter files.

2 List of S-parameter files (Channel 1)

This control shows the current list of S-parameter files used for deembedding on channel 1. To add or remove files from the list use respective controls **Add S-parameter files to list (Channel 1)** on page 155 and **Remove S-parameter files from list (Channel 1)** on page 155.

3 Add S-parameter files to list (Channel 1)

This control can be used to add S-parameter files to the current list of files for channel 1. A file dialog will open and lets you select a S-parameter file (extension *.s2p)

4 Remove S-parameter files from list (Channel 1)

This control can be used to remove an S-parameter files from the current list of files for channel 1. A list box will open up showing the currently selected files and which files should be removed.

5 Deembedding mode (Channel 1)

This control sets the deembedding mode for channel 1. When selecting Amplitude only the deembedding will use only the amplitude response from the S-parameter file whereas Amplitude and Phase will use both Amplitude and Phase.

Available Settings:

- Amplitude only
- Amplitude and Phase

6 Remove common delay (linear phase)

This check box enables or disabled the removal of a common delay from the S-parameter files for channels 1-4. This feature might give better deembedding results when using S-parameter files from long cables which normally contain a large absolute channel delay.

7 S-parameter deembedding controls (Channel 2-4)

This group of elements represents the same controls as **Enable S-parameter deembedding (Channel 1)** on page 154 to **Deembedding mode (Channel 1)** on page 155 for channels 2-4.

Corrections (Use FIR file mode)

In this mode, all corrections that are usually performed by the 81195A OMG software are disabled and the FIR filter coefficients can be set manually by providing user-defined files. [Figure 55](#) on page 156 shows the *Corrections* tab when set to *Use FIR Files* mode and the individual controls are explained below.

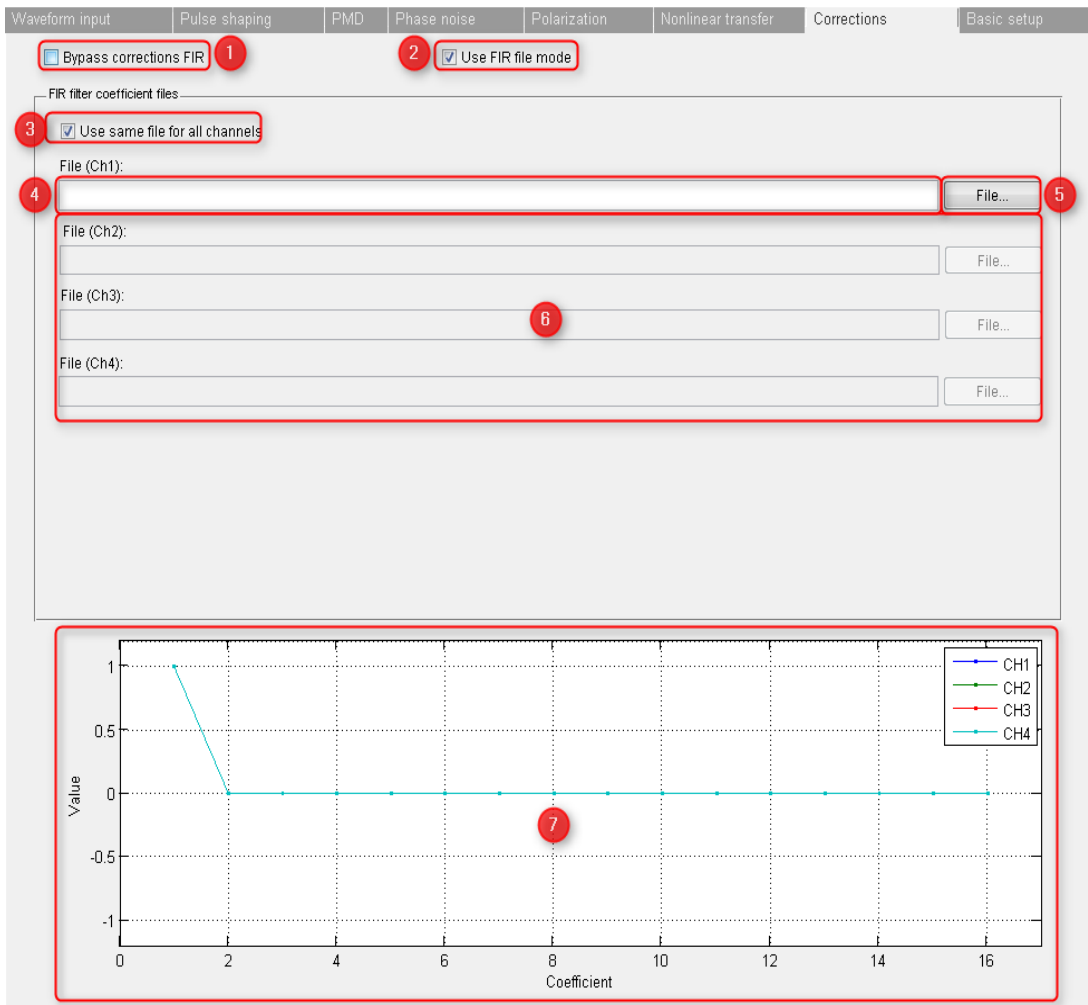

Figure 55 Corrections tab (FIR file mode)

1 Bypass correction FIR

This control is described in section **Bypass correction FIR** on page 149.

2 Use FIR file mode

This control is described in section **Use FIR file mode** on page 150

3 Use same file for all channels

This check box enables or disables the controls for AWG channels 2-4. If the check box is set the same filter settings are used for all channels (default).

4 Correction filter file name (Channel 1)

This control displays or allows to directly set the currently selected correction filter file or channel 1.

See section [File Formats and Example Files](#) on page 277 for details on the file format.

5 Correction filter file... (Channel 1)

This control opens a file dialog to select the current correction filter file for channel 1.

6 Correction filter files (Channel 2-4)

This group of elements represents the same controls as **Correction filter file name (Channel 1)** on page 157 and **Correction filter file... (Channel 1)** on page 157 for channels 2-4.

7 Correction filter impulse response

This plot displays the impulses of the currently loaded FIR coefficient files.

Basic Setup

Basic Setup

The basic setup tab contains fundamental controls to setup and configure the connected AWG modules. Depending on the selected module configuration and waveform creation mode (see [Waveform Creation Modes](#) on page 26) the respective channel controls are enabled or disabled automatically.

The upper half of the tab shows the currently selected module setup. You can select between the following module configurations:

- Dual IQ pair (4 channels)
Requires an AWG module with 4 output channels (options #004)
- Single IQ pair (2 channels)
Requires an AWG module with at least 2 output channels (options #002, #004)
- Dual IQ pair (multi module)
Requires four M8195A modules with at least one output channel (options #001, #002, #004) and an M8197A synchronization module
- Dual IQ pair (multi module)
Requires two M8195A modules with at least one output channel (options #001, #002, #004) and an M8197A synchronization module

In *Single IQ pair* mode (2 AWG channels) the waveform is generated on channels 1 and 4. Channels 2 and 3 are powered down and cannot be enabled (see also [8]). See [Table 14](#) on page 158 for available channels mappings.

Table 14 Channel configurations

Configuration	Available AWG channels	Available data channels	Channel mapping
2 Channel module Waveform mode	CH1, CH4	XI, XQ	Variable
2x1 Channel module Waveform mode	CH1, CH2	XI, XQ	Variable

Configuration	Available AWG channels	Available data channels	Channel mapping
2 Channel module Real-time mode	CH1, CH4	XI, XQ	XI-> CH1 XQ -> CH4
4 Channel module Waveform mode	CH1, CH2, CH3, CH4	XI, XQ, YI, YQ	Variable
4 Channel module Real-time mode	CH1, CH2, CH3, CH4	XI, XQ, YI, YQ	XI-> CH1, XQ -> CH2 YI-> CH3, YQ -> CH4

Some controls in the basic setup tab are disabled permanently and will be used in future versions.

NOTE

When changing the module configuration or waveform creation mode the channel setup (e.g. channel mapping) might be adjusted automatically. Please remark that some of these settings are not reverted to their original values when changing back to the previous configuration.

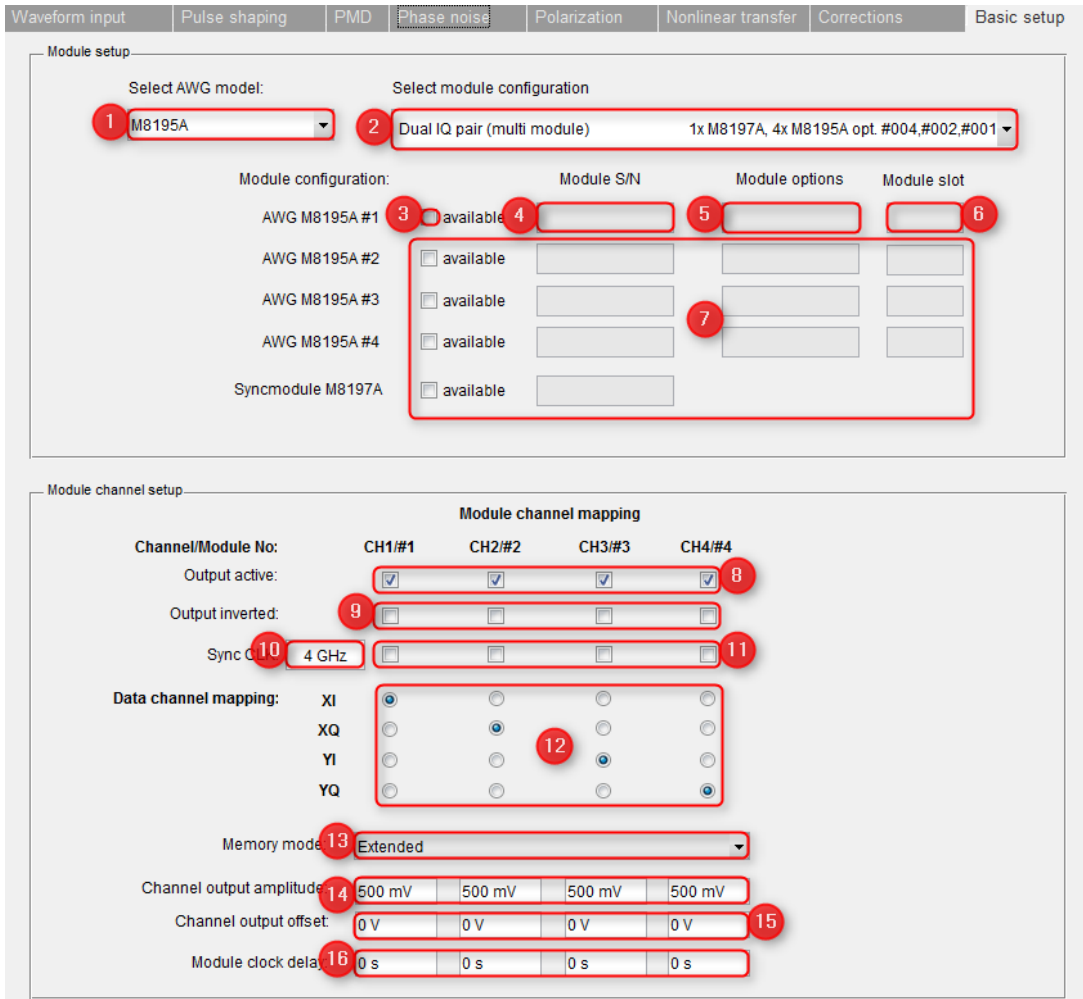

Figure 56 Illustration of Waveform Mode operation

1 AWG Model

This control selects the type of AWG to be used. Depending on the selected AWG Model certain features and modes of operations may be unavailable. Allowed ranges of certain controls will be automatically adjusted based on this setting as well.

Available Settings

- M8194A
- M8195A
- M8196A
- 89600 VSA

2 Module configuration

This control selects the module configuration. To check if the currently selected configuration is valid click Verify Setup (see **Verify Setup** on page 70)

NOTE

After changing and verifying the module configuration a complete module initialization is required (see **Initialize / Reset Module(s)** on page 71 for details)

3 Module available

This check box indicates if the listed AWG is available and VISA communication to the module works.

4 Module serial number

This control displays the AWG's serial number.

5 Module options

This control displays the AWG's model options.

6 Module slot

This control displays the AWG's mainframe slot, once Verify Setup has been performed.

7 Multi module setup

For multi module setups, this section displays module available, module serial number, module options and module slot for modules two to four and for the synchronization module.

8 Channel output active

These check boxes enable or disable the corresponding AWG channels.

NOTE

Changes will be sent to the AWG immediately.

9 Channel output inverted

These check boxes can be used to invert the output on the respective AWG channel.

NOTE

These controls are only available in waveform mode.

10 Synchronization clock frequency

This control sets the frequency of the auxiliary synchronization signal.

NOTE

These controls are only available in waveform mode.

11 Synchronization clock channel

These controls can be used to output an auxiliary synchronization signal to a defined output channel. The synchronization signal is a sine waveform with the frequency set in **Synchronization clock frequency** on page 162.

NOTE

These controls are only available in waveform mode.

12 Data channel mapping

These controls set the current data channel mapping

Default data channel mappings:

- 4 channel configuration:
XI->CH1, XQ->CH2, YI->CH3, YQ->CH4
- 2 channel configuration:
XI->CH1, XQ->CH4 (single module)
XI->CH1, XQ->CH2 (multi module)
YI and YQ not available

NOTE

These controls are only available in waveform mode.

13 Memory mode

This control selects between internal and extended memory mode. In real-time mode the extended memory mode is default. In single module waveform operation, Internal mode is required. In multi module waveform operation, Extended mode is required.

NOTE

This control is only available in real-time mode.

14 Channel output amplitude

These controls set the output amplitude of the corresponding AWG channels.

NOTE

Changes will be sent to the AWG immediately.

15 Channel output offset

These controls set the output offset of the corresponding AWG channels.

NOTE

Changes will be sent to the AWG immediately.

16 Module clock delay

When working with a multi module setup, the individual AWG modules are synchronized by the M8197A module. For ideally synchronous signal outputs of the individual modules, the relative delays between the respective modules needs to be provided through these controls. See the *M8197A User's Guide* for further details.

NOTE

Delays between different AWG modules may be too large to be easily extracted from VSA/OMA measurements of modulated data signals. Generating standard waveforms can be a helpful tool instead.

6 General Programming

[SCPI Programming Overview](#) / 166

[SCPI Programming Reference](#) / 171

[CHANnel Subsystem](#) / 177

[CORRections Subsystem](#) / 181

[PULSeshaper Subsystem](#) / 190

[SETTings Subsystem](#) / 194

[SETup Subsystem](#) / 199

[SPRoperties Subsystem](#) / 224

[WAVEform Subsystem](#) / 259

SCPI Programming Overview

Introduction

The 81195A OMG software can be programmed using SCPI commands through LAN protocols. SCPI control can be performed on a single PC as well as from one PC to another, using an actual LAN connection in between.

General

For each GUI control there's a corresponding SCPI command / query. Therefore, the SCPI programming reference contains only simple descriptions for each command / query. For full detail, refer to the corresponding GUI sections of this User's Guide. The next few paragraphs describe some basics regarding GUI / SCPI equivalence.

Most button controls, such as Apply buttons, are represented by SCPI commands without parameters. Some GUI buttons or menu items (those handling loading and saving settings) open a file select dialog. Their SCPI equivalents take (and require) the filename as an input parameter.

Drop-down controls are represented by SCPI commands / queries using short or long names representing the menu choices (values must be sent / are queried with quotes).

The SCPI commands / queries for numeric controls do not support metric prefixes. For instance setting the sampling rate to 64 GHz can be done using 64000000000 or 64e9 or 6.4e+10.

If a GUI control is disabled, the corresponding SCPI command / query will be unavailable too. In most cases, the control is disabled based on the current values of other controls. In those cases, the query operation will be available via SCPI, but it will return an error message. A few controls are permanently read-only. For those elements, there is no SCPI query implemented. This is indicated in the SCPI programming reference (see [SCPI Programming Overview](#) on page 166).

In the help menu, SCPI overlay mode can be activated (see section [SCPI Overlay Show / Hide](#) on page 55) to show the SCPI representation of the currently visible controls. It will remain active until turned off in the same menu.

Visa Resource Names and LAN interfaces

The Visa resource string consists of the interface ID, the hostname and an address ID that is describing the specific instance of the 81195A OMG software.

The interface ID depends on the PC that the SCPI commands are going to be sent from. Usually this ID is 'TCPIP0'. Keysight Connection Expert can be used to check whether more than one LAN interface is available. The Connection Expert can also be used to automatically search for instruments and software instances on the LAN interface(s).

The hostname can either be an IP address or an actual hostname in case there is a DNS server available, resolving the name to the corresponding IP address. If SCPI programming is to be used from the same PC that the 81195A software is running on, 'localhost' can be used as hostname.

The specific instance ID can be obtained from the window title bar of the 81195A OMG software.

The following example shows how to address the running instance of the 81195A OMG software from the same PC using HiSLIP and Socket protocol, assuming a single LAN interface.

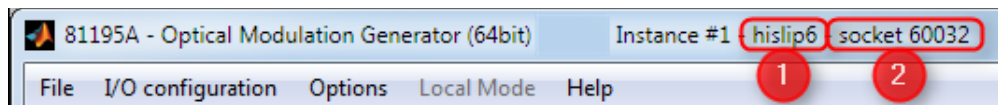

Figure 57 Addressing the running instance of the 81195A OMG software

Visa address (HiSLIP):

```
TCPIP0::localhost::hislip6::INSTR
```

Visa address (Socket):

```
TCPIP0::localhost::60032::SOCKET
```

NOTE

The socket port can be configured in the 81195A OMG Instance Manager when the corresponding OMG instance is not running (see section [Socket Port](#) on page 43).

HiSLIP protocol

This protocol is recommended. To use the HiSLIP protocol an I/O library such as the Keysight I/O Libraries Suite must be installed. The protocol might not be supported by an installed I/O library if that library is too old. Keysight I/O Libraries Suite 16.3 and above supports the HiSLIP protocol. However, the Keysight I/O Libraries Suite might be installed as secondary I/O library. In this case, check if the primary I/O library supports HiSLIP. If it does not, the socket protocol must be used.

NOTE

HiSLIP addresses are assigned automatically, whenever a new instrument or software is connected using this protocol. However, only a limited number of different instruments using this protocol are supported. In case there are any issues registering the HiSLIP address for the 81195A OMG software, the file %ProgramData%\Agilent\ACCL\AgilentScpiloReservedDeviceNames.xml might be checked for obsolete entries.

Socket protocol

This protocol can be used with any I/O library or using standard operating system socket functionality connecting to the configured port. This protocol must be used if the used I/O library is not supporting HiSLIP protocol.

NOTE

The socket port can be configured in the 81195A OMG Instance Manager when the corresponding OMG instance is not running (see section [Launching the 81195A Optical Modulation Generator Software on page 42](#)).

Identifying the 81195A OMG software instance

Using the common SCPI command *IDN? the 81195A OMG software instance can be easily identified, since the response contains the user-defined instance name, set in the 81195A OMG Instance Manager.

Example (for version 2.2.7 of the 81195A OMG software):

```
->*IDN?
```

```
<-Keysight Technologies,81195A,Instance #1,2.2.7
```

Timeout settings

Certain operations, such as initiating transfer of long data patterns with :OMG:SEND, may take some time before completion. If a SCPI command is followed by a SCPI query, the query will be executed after the command has completed. If instead another SCPI command is to be sent, *OPC? can be used to wait for completion of the active command before continuing. It may be necessary to increase the timeout setting of the Visa connection for operations that take a lot of time.

Reading and clearing error messages

The :OMG:LASTError? query returns the last error that occurred in the 81195A software. This query does not return the full error queue if more than one error occurred during the previous operation but only the last one.

The :OMG:LASTError:CLEAr command clears the last error message returned by the command :OMG:LAST?. Since the command :OMG:LAST? does not return an error queue but only a single message, :OMG:LAST:CLEAr needs to be called just once to clear the error status.

NOTE

Usually the error message is identical or similar to the error messages shown in the status bar and warnings / errors dialog of the GUI. In the unlikely situation that the GUI shows multiple error messages for a single operation, the same operation performed through SCPI just returns the last error message. All error messages as well as any warnings can be checked in the GUI dialog, though, even when operating through SCPI.

Local mode and remote operation

Whenever the 81195A Optical Modulation Generator software is remote controlled, the GUI will be set to disabled state, to avoid unintended interruption due to local GUI activity. Press the Local Mode menu item to take back control over the GUI.

Example Program

```
Reset all settings to default
:OMG:SETT:ALL:DEF
```

Set instrument Visa address

```
:OMG:SET:INST:MOD1:ADDR
'TCPIP0::localhost::hislip0::INSTR'
```

Verify Setup

```
:OMG:VER
```

Initialize Setup (:OMG:VER has to be executed first)

```
:OMG:INIT Use built-in frequency response characteristics:OMG:
:CORR:BUILT:ACT 1
```

Use standard cable correction

```
:OMG:CORR:SCAB:ACT 1
```

Activate skew corrections and set skew values

```
:OMG:CORR:SKEW:ACT 1:OMG:CORR:SKEW:XY
-13.6e-12:OMG:CORR:SKEW:XIQ
-4.5e-12:OMG:CORR:SKEW:YIQ +5.5e-12
```

Set sampling rate to 63GHz

```
:OMG:SET:CLOC:SAMPL 63E9
```

Set modulation format

```
:OMG:WAV:MOD:FORM 'QAM16'
```

(With option 81195A-RSP) Switch to real-time mode

```
:OMG:MODE 'REAL'
```

Set data pattern

```
:OMG:WAV:DATA:PRBS 'PRBS9ITU'
```

Send data to module and start playback

```
:OMG:SEND
```

(With option 81195A-OSP) Activate general phase noise emulation

```
:OMG:SPR:PHAS:ROT2:BY 0
```

(With option 81195A-OSP) Activate phase noise pattern

```
:OMG:SPR:PHAS:ROT2:PATT:ACT 1
```

(With option 81195A-OSP) Set linewidth to 1MHz

```
:OMG:SPR:PHAS:ROT2:PATT:MOD:LIN 1E6
```

Send updated data to module and start playback (not required in real-time mode (with option 81195A-RSP))

```
:OMG:SEND
```

SCPI Programming Reference

The Optical Modulation Generator software has the following commands and subsystems:

Table 15

Name	Description under
:OMG:INITialize	:OMG:INITialize on page 172
:OMG:MODE[?]	:OMG:MODE[?] on page 172
:OMG:VSA:LOAD	:OMG:VSA:LOAD on page 172
:OMG:SEND	:OMG:SEND on page 173
:OMG:TOGGlerun	:OMG:TOGGlerun on page 173
:OMG:TRATe?	:OMG:TRATe? on page 173
:OMG:VERify	:OMG:VERify on page 174
:OMG:DATA:PATtern:KEEP[?]	:OMG:DATA:PATtern:KEEP[?] on page 174
:OMG:DSP:SCALing:AUTO[?]	:OMG:DSP:SCALing:AUTO[?] on page 174
:OMG:NSAMples:AUTO[?]	:OMG:NSAMples:AUTO[?] on page 175
:OMG:ARESampling[?]	:OMG:ARESampling[?] on page 175
:OMG:LASTerror?	:OMG:LASTerror? on page 176
:OMG:LASTerror:CLEar	:OMG:LASTerror:CLEar on page 176
Subsystems	
	CHANnel Subsystem on page 177
	CORRections Subsystem on page 181
	PULSeshaper Subsystem on page 190
	SETTings Subsystem on page 194
	SETUp Subsystem on page 199
	SPRoperties Subsystem on page 224
	WAVEform Subsystem on page 259

:OMG:INITialize

Command	:OMG:INIT
Long	:OMG:INITialize.
Parameters	None
Description	Initialize/Reset AWG modules. Requires Verify Setup to be performed first
Example	Command: :OMG:INIT

:OMG:MODE[?]

Required Option	#RSP
Command	::OMG:MODE?
Long	:OMG:MODE?
Parameters	None
Description	Set or query the data generation mode (waveform or real-time).
Example	Command: :OMG:MODE 'WAVE' Query: :OMG:MODE?

:OMG:VSA:LOAD

Command	:OMG:VSA:LOAD
Long	:OMG:VSA:LOAD
Parameters	None
Description	Generate waveform and load it in VSA. Requires Verify Setup to be performed first. Requires VSA to be running and configured appropriately.
Further details	See section Basic Controls Bar on page 70.
Example	Command: :OMG:VSA:LOAD

:OMG:SEND

Command	:OMG:SEND
Long	:OMG:SEND.
Parameters	None
Description	Generate waveform/symbol data and send it to AWG modules. Requires Initialize / Reset Module(s) to be performed first
Example	Command: :OMG:SEND

:OMG:TOGGlerun

Command	:OMG:TOGG
Long	:OMG:TOGGlerun
Parameters	None
Description	Stop or Restart playback on AWG module(s). Requires Send Data to Module(s) to be performed first
Example	Command: :OMG:TOGG

:OMG:TRATe?

Command	:OMG:TRAT?
Long	:OMG:TRATe?
Parameters	None
Description	Query the overall transmission, based on sampling rate settings and modulation format.
Example	Query: :OMG:TRAT?

:OMG:VERify

Command	:OMG:VER
Long	:OMG:VERify
Parameters	None
Description	Verify instruments and software. Requires VISA addresses to be configured first. AWG Soft Front Panel software needs to be running as well as VSA software, if VSA software is to be used. Certain operations won't be available unless setup has been successfully verified.
Example	Command: :OMG:VER

:OMG:DATA:PATtern:KEEP[?]

Command	:OMG:DATA:PATT:KEEP[?]
Long	:OMG:DATA:PATtern:KEEP[?]
Parameters	0 1
Description	Set or query whether temporary symbol pattern files are to be kept permanently. Speeds up subsequent sessions at the cost of disk space
Further details	See section Options on page 51.
Example	Command: :OMG:DATA:PATT:KEEP 1 Query: :OMG:DATA:PATT:KEEP?

:OMG:DSP:SCALing:AUTO[?]

Command	:OMG:DSP:SCAL:AUTO[?]
Long	:OMG:DSP:SCALing:AUTO[?]
Parameters	0 1
Description	Set or query whether autoscaling for the DSP stages is enabled
Further details	See section Options on page 51.

Example Command:
 :OMG:DSP:SCAL:AUTO 1
 Query:
 :OMG:DSP:SCAL:AUTO?

:OMG:NSAMples:AUTO[?]

Command :OMG:NSAM:AUTO[?]
 Long :OMG:NSAMples:AUTO[?]
 Parameters 0|1
 Description Set or query whether the recommended number of samples and the recommended sampling rate are applied automatically.
 Further details See section [Basic Controls Bar](#) on page 70

Example Command:
 :OMG:NSAM:AUTO 1
 Query:
 :OMG:NSAM:AUTO?

:OMG:ARESampling[?]

Command :OMG:ARES[?]
 Long :OMG:ARESampling[?]
 Parameters 0|1
 Description Set or query whether to use arbitrary resampling for the calculation of complex modulated waveforms.
 Further details See section [Options](#) on page 51.

Example Command:
 :OMG:ARES 1
 Query:
 :OMG:ARES?

:OMG:LASTError?

Command	:OMG:LAST?
Long	:OMG:LASTError?
Parameters	None
Description	Returns the last error that occurred in the 81195A software. Please note that this command does not return the full error queue if more than one error occurred during the previous operation but only the last one.
Example	Query: :OMG:LAST?

:OMG:LASTError:CLEar

Command	:OMG:LAST:CLE
Long	:OMG:LASTError:CLEar
Parameters	None
Description	Clears the last error message returned by the command “:OMG:LAST?”. Since the command “:OMG:LAST?” does not return an error queue but only a single message, “:OMG:LAST:CLE” needs to be called just once to clear the error status.
Example	Command: :OMG:LAST:CLE

CHANnel Subsystem

This subsystem has the following commands:

Table 16

Name	Description under
:OMG:CHANnel1 2 3 4:ACTive[?]	:OMG:CHANnel1 2 3 4:ACTive[?] on page 177
:OMG:CHANnel1 2 3 4:AMPLitude[?]	:OMG:CHANnel1 2 3 4:AMPLitude[?] on page 178
:OMG:CHANnel1 2 3 4:INVerted[?]	:OMG:CHANnel1 2 3 4:INVerted[?] on page 178
:OMG:CHANnel1 2 3 4:MDELay[?]	:OMG:CHANnel1 2 3 4:MDELay[?] on page 178
:OMG:CHANnel1 2 3 4:OFFSet[?]	:OMG:CHANnel1 2 3 4:OFFSet[?] on page 179
:OMG:CHANnel1 2 3 4:SCLock[?]	:OMG:CHANnel1 2 3 4:SCLock[?] on page 179
:OMG:CHANnel1 2 3 4:SOURce[?]	:OMG:CHANnel1 2 3 4:SOURce[?] on page 180

:OMG:CHANnel1|2|3|4:ACTive[?]

Command :OMG:CHAN1|2|3|4:ACT[?]

Long :OMG:CHANnel1|2|3|4:ACTive[?]

Parameters 0|1

Description Set or query whether the respective AWG channel output port is enabled or disabled.

Example Command:

:OMG:CHAN1:ACT 1

Query:

:OMG:CHAN1:ACT?

:OMG:CHANnel1|2|3|4:AMPLitude[?]

Command	:OMG:CHAN1 2 3 4:AMPL[?]
Long	:OMG:CHANnel1 2 3 4:AMPLitude[?]
Parameters	Numeric value
Description	Set or query the output amplitude of the respective AWG channel.
Example	Command: OMG:CHAN1:AMPL 500E-3 Query: :OMG:CHAN1:AMPL?

:OMG:CHANnel1|2|3|4:INVerted[?]

Command	:OMG:CHAN1 2 3 4:INV[?]
Long	:OMG:CHANnel1 2 3 4:AMPLitude[?]
Parameters	0 1
Description	Set or query whether the respective AWG channel data is inverted. Not available in Real-time mode.
Example	Command: :OMG:CHAN1:INV 0 Query: :OMG:CHAN1:INV?

:OMG:CHANnel1|2|3|4:MDELay[?]

Command	:OMG:CHAN1 2 3 4:MDEL[?]
Long	:OMG:CHANnel1 2 3 4:MDELay[?]
Parameters	Numeric value
Description	Set or query the clock delay of the respective AWG module. Available in multi module configuration only.
Example	Command: :OMG:CHAN1:MDEL 0

Query:
:OMG:CHAN1:MDEL?

:OMG:CHANnel1|2|3|4:OFFSet[?]

Command :OMG:CHAN1|2|3|4:OFFS[?]
 Long :OMG:CHANnel1|2|3|4:OFFSet[?]
 Parameters Numeric value
 Description Set or query the output offset voltage of the respective AWG channel.
 Example Command:
 :OMG:CHAN1:OFFS 0
 Query:
 :OMG:CHAN1:OFFS?

:OMG:CHANnel1|2|3|4:SCLock[?]

Command :OMG:CHAN1|2|3|4:SCL[?]
 Long :OMG:CHANnel1|2|3|4:SCLock[?]
 Parameters 0|1
 Description Set or query whether a sinusoidal signal is generated on the respective AWG channel. Overrides any other settings that would otherwise define the signal. Not available in Real-time mode.
 Example Command:
 :OMG:CHAN1:SCL 0
 Query:
 :OMG:CHAN1:SCL?

:OMG:CHANnel1|2|3|4:SOURce[?]

Command	:OMG:CHAN1 2 3 4:SOUR[?]
Long	:OMG:CHANnel1 2 3 4:SOURce[?]
Parameters	HI HQ VI VQ (enclosed in single or double quotes)
Description	Set or query the data channel mapped to the respective physical AWG channel.
Example	Command: :OMG:CHAN1:SOUR 'HI' Query: :OMG:CHAN1:SOUR?

CORRections Subsystem

This subsystem has the following commands:

Table 17

Name	Description under
:OMG:CORRections:BYPass[?]	:OMG:CORRections:BYPass[?] on page 182
::OMG:CORRections:MDEemphasis?	:OMG:CORRections:MDEemphasis? on page 182
:OMG:CORRections:SBANdwidth[?]	:OMG:CORRections:SBANdwidth[?] on page 182
:OMG:CORRections:BUILTin:ACTive[?]	:OMG:CORRections:BUILTin:ACTive[?] on page 183
:OMG:CORRections:DSP:FIR:CGAin[?]	:OMG:CORRections:DSP:FIR:CGAin[?] on page 183
:OMG:CORRections:FIR:FMODE:ACTive[?]	:OMG:CORRections:FIR:FMODE:ACTive[?] on page 183
:OMG:CORRections:FIR:FMODE:SAME[?]	:OMG:CORRections:FIR:FMODE:SAME[?] on page 184
:OMG:CORRections:FIR:XI XQ YI YQ:FILE[?]	:OMG:CORRections:FIR:XI XQ YI YQ:FILE[?] on page 184
:OMG:CORRections:GAIN:ACTive[?]	:OMG:CORRections:GAIN:ACTive[?] on page 185
:OMG:CORRections:GAIN:XI XQ YI YQ[?]	:OMG:CORRections:GAIN:XI XQ YI YQ[?] on page 185
:OMG:CORRections:SCABle:ACTive[?]	:OMG:CORRections:SCABle:ACTive[?] on page 185
::OMG:CORRections:SKEW:ACTive[?]	:OMG:CORRections:SKEW:ACTive[?] on page 186
:OMG:CORRections:SKEW:XI XQ YI YQ XY[?]	:OMG:CORRections:SKEW:XI XQ YI YQ XY[?] on page 186
OMG:CORRections:SPARameters:ACTive[?]	:OMG:CORRections:SPARameters:ACTive[?] on page 186
:OMG:CORRections:SPARameters:CHANnel1 2 3 4:ENABle[?]	:OMG:CORRections:SPARameters:CHANnel1 2 3 4:ENABle[?] on page 187
:OMG:CORRections:SPARameters:CHANnel1 2 3 4:FILElist[?]	:OMG:CORRections:SPARameters:CHANnel1 2 3 4:FILElist[?] on page 188
:OMG:CORRections:SPARameters:CHANnel1 2 3 4:MODE[?]	:OMG:CORRections:SPARameters:CHANnel1 2 3 4:MODE[?] on page 188
:OMG:CORRections:VSAEqualizer:ACTive[?]	:OMG:CORRections:VSAEqualizer:ACTive[?] on page 189
:OMG:CORRections:VSAEqualizer:READ	:OMG:CORRections:VSAEqualizer:READ on page 189

:OMG:CORRections:BYPass[?]

Command :OMG:CORR:BYP[?]
 Long :OMG:CORRections:BYPass[?]
 Parameters 0|1
 Description Set or query whether all corrections enabled. If BYPass is set to 1, corrections are disabled.
 Example :OMG:CORR:BYP 0
 Query:
 :OMG:CORR:BYP?

:OMG:CORRections:MDEemphasis?

Command :OMG:CORR:MDE?
 Long :OMG:CORRections:MDEemphasis?
 Parameters None
 Description Query the maximum deemphasis required to achieve a flat frequency response. Gain imbalance settings do not affect this value.
 Example Query:
 :OMG:CORR:MDE?

:OMG:CORRections:SBANdwidth[?]

Command :OMG:CORR:SBAN[?]
 Long :OMG:CORRections:SBANdwidth[?]
 Parameters Numeric value
 Description Set or query the bandwidth within which the maximum deemphasis is computed.
 Example Command:
 :OMG:CORR:SBAN 20E9
 Query:
 :OMG:CORR:SBAN?

:OMG:CORRections:BuILTin:ACTive[?]

Command	:OMG:CORR:BuILT:ACT[?]
Long	:OMG:CORRections:BuILTin:ACTive[?]
Parameters	0 1
Description	Set or query whether built-in channel characteristics of the AWG module(s) is obtained and corresponding correction ins applied.
Example	Command: :OMG:CORR:BuILT:ACT 0 Query: :OMG:CORR:BuILT:ACT?

:OMG:CORRections:DSp:FIR:CGAin[?]

Required Option	#OSP
Command	:OMG:CORR:DSp:FIR:CGA[?]
Long	:OMG:CORRections:DSp:FIR:CGAin[?]
Parameters	Numeric value
Description	Set or query the common gain value for the corrections DSP stage. Only available in Real-time mode.
Example	Command: :OMG:CORR:DSp:FIR:CGA 1 Query: :OMG:CORR:DSp:FIR:CGA?

:OMG:CORRections:FIR:FMODe:ACTive[?]

Command	:OMG:CORR:FIR:FMODe:ACT[?]
Long	:OMG:CORRections:FIR:FMODe:ACTive[?]
Parameters	0 1
Description	Set or query whether to use FIR file mode for corrections.

Example Command:
:OMG:CORR:FIR:FMOD:ACT 0
Query:
:OMG:CORR:FIR:FMOD:ACT?

:OMG:CORRections:FIR:FMODe:SAME[?]

Command :OMG:CORR:FIR:FMOD:SAME[?]
Long :OMG:CORRections:FIR:FMODe:SAME[?]
Parameters 0|1
Description Set or query whether to use the same (first) FIR file for all other channels as well.
Example Command:
:OMG:CORR:FIR:FMOD:SAME 0
Query:
:OMG:CORR:FIR:FMOD:SAME?

:OMG:CORRections:FIR:XI|XQ|YI|YQ:FILE[?]

Command :OMG:CORR:FIR:XI|XQ|YI|YQ:FILE[?]
Long :OMG:CORRections:FIR:XI|XQ|YI|YQ:FILE[?]
Parameters String value
Description Set or query the filename to be used for the respective channel if FIR mode is enabled for corrections. File needs to be located either on the PC that the 81195A OMG software is running on or on a network location, accessible by that PC.
Example Command:
:OMG:CORR:FIR:XI:FILE '<filename>'
Query:
:OMG:CORR:FIR:XI:FILE?

:OMG:CORRections:GAIN:ACTive[?]

Command :OMG:CORR:GAIN:ACT[?]
 Long :OMG:CORRections:GAIN:ACTive[?]
 Parameters 0|1
 Description Set or query whether gain imbalance correction is applied.
 Example Command:
 :OMG:CORR:GAIN:ACT 0
 Query:
 :OMG:CORR:GAIN:ACT?

:OMG:CORRections:GAIN:XI|XQ|YI|YQ[?]

Command :OMG:CORR:GAIN:XI|XQ|YI|YQ[?]
 Long :OMG:CORRections:GAIN:XI|XQ|YI|YQ[?]
 Parameters Numeric value
 Description Set or query the relative gain of the respective channel.
 Example Command:
 :OMG:CORR:GAIN:XI 0
 Query:
 :OMG:CORR:GAIN:XI?

:OMG:CORRections:SCABle:ACTive[?]

Command :OMG:CORR:SCAB:ACT[?]
 Long :OMG:CORRections:SCABle:ACTive[?]
 Parameters 0|1
 Description Set or query whether skew correction is applied.
 Example Command:
 :OMG:CORR:SCAB:ACT 0
 Query:
 :OMG:CORR:SCAB:ACT?

:OMG:CORRections:SKEW:ACTive[?]

Command :OMG:CORR:SKEW:ACT[?]
 Long :OMG:CORRections:SKEW:ACTive[?]
 Parameters 0|1
 Description Set or query whether skew correction is applied.
 Example Command:
 :OMG:CORR:SKEW:ACT 0
 Query:
 :OMG:CORR:SKEW:ACT?

:OMG:CORRections:SKEW:XIQ|YIQ|XY[?]

Command :OMG:CORR:SKEW:XIQ|YIQ|XY[?]
 Long :OMG:CORRections:SKEW:XIQ|YIQ|XY[?]
 Parameters Numeric value
 Description Set or query the time delay to be introduced between the I and Q channels of the respective polarization or between X and Y polarization.
 Example Command:
 :OMG:CORR:SKEW:XIQ 0
 Query:
 :OMG:CORR:SKEW:XIQ?

:OMG:CORRections:SPARameters:ACTive[?]

Command :OMG:CORR:SPAR:ACT[?]
 Long :OMG:CORRections:SPARameters:ACTive[?]
 Parameters 0|1
 Description Set or query whether s-parameter file correction is applied. Note that s-parameter correction can be toggled for each channel in the respective subsection.
 Example Command:
 :OMG:CORR:SPAR:ACT 0

Query:
:OMG:CORR:SPAR:ACT?

:OMG:CORRections:SPARameters:REMovecommon[?]

Command :OMG:CORR:SPAR:REM[?]
 Long :OMG:CORRections:SPARameters:REMovecommon[?]]
 Parameters 0|1
 Description Set or query whether a common delay should be removed from the individual channel phase responses.
 Example Command:
 :OMG:CORR:SPAR:REM 0
 Query:
 :OMG:CORR:SPAR:REM?

:OMG:CORRections:SPARameters:CHANnel1|2|3|4:ENABLE[?]

Command :OMG:CORR:SPAR:CHAN1|2|3|4:ENAB[?]
 Long :OMG:CORRections:SPARameters:CHANnel1|2|3|4:ENABLE[?]
 Parameters 0|1
 Description Set or query whether s-parameter file correction is applied for the respective channel. In addition s-parameter correction needs to be activated in the corrections configuration.
 Example Command:
 :OMG:CORR:SPAR:CHAN1:ENAB 0
 Query:
 :OMG:CORR:SPAR:CHAN1:ENAB?

:OMG:CORRections:SPARameters:CHANnel1|2|3|4:FILElist[?]

Command :OMG:CORR:SPAR:CHAN1|2|3|4:FILE[?]

Long :OMG:CORRections:SPARameters:CHANnel1|2|3|4:FILElist[?]

Parameters String value

Description Set or query the filename(s) of the s-parameter files to be used for the respective channel. Multiple filenames may be concatenated using a semicolon as a separator.

File needs to be located either on the PC that the 81195A OMG software is running on or on a network location, accessible by that PC.

Example Command:

:OMG:CORR:SPAR:CHAN1:FILE '<filename>'

Query:

:OMG:CORR:SPAR:CHAN1:FILE?

:OMG:CORRections:SPARameters:CHANnel1|2|3|4:MODE[?]

Command :OMG:CORR:SPAR:CHAN1|2|3|4:MODE[?]

Long :OMG:CORRections:SPARameters:CHANnel1|2|3|4:MODE[?]

Parameters AMPLitude|FULL (enclosed in single or double quotes)

Description Set or query whether correction based on VSA equalizer data is applied.

Further details See section [Corrections](#) on page 146.

Example Command:

:OMG:CORR:SPAR:CHAN1:MODE 'AMPL'

Query:

:OMG:CORR:SPAR:CHAN1:MODE?

:OMG:CORRections:VSAEqualizer:ACTive[?]

Command	:OMG:CORR:VSAE:ACT[?]
Long	:OMG:CORRections:VSAEqualizer:ACTive[?]
Parameters	0 1
Description	Set or query whether correction based on VSA equalizer data is applied.
Further details	See section Corrections on page 146
Example	Command: :OMG:CORR:VSAE:ACT 0 Query: :OMG:CORR:VSAE:ACT?

:OMG:CORRections:VSAEqualizer:READ

Command	:OMG:CORR:VSAE:READ
Long	:OMG:CORRections:VSAEqualizer:READ
Parameters	None
Description	Read current equalizer data from VSA. Requires VSA to be running.
Further details	See section Corrections on page 146
Example	Command: :OMG:CORR:VSAE:READ

PULSeshaper Subsystem

This subsystem has the following commands:

Table 18

Name	Description under
:OMG:PULSeshaper:BYPass[?]	:OMG:PULSeshaper:BYPass[?] on page 190
:OMG:PULSeshaper:SAME[?]	:OMG:PULSeshaper:SAME[?] on page 191
:OMG:PULSeshaper:DSP:FIR:CGAin[?]	:OMG:PULSeshaper:DSP:FIR:CGAin[?] on page 191
:OMG:PULSeshaper:X Y:FILE[?]	:OMG:PULSeshaper:X Y:FILE[?] on page 192
:OMG:PULSeshaper:X Y:FILTer[?]	:OMG:PULSeshaper:X Y:FILTer[?] on page 192
:OMG:PULSeshaper:X Y:ROLLoff[?]	:OMG:PULSeshaper:X Y:ROLLoff[?] on page 193

:OMG:PULSeshaper:BYPass[?]

Command :OMG:PULS:BYP[?]

Long :OMG:PULSeshaper:BYPass[?]

Parameters 0|1

Description Set or query whether the pulse shaping filter function set for X polarization should be used for Y polarization as well.

Further details See section [Pulse Shaping](#) on page 98.

Example Command:
:OMG:PULS:BYP 1
Query:
:OMG:PULS:BYP?

:OMG:PULSeshaper:SAME[?]

Command	:OMG:PULS:SAME[?]
Long	:OMG:PULSeshaper:SAME[?]
Parameters	0 1
Description	Set or query whether the pulse shaping filter function set for X polarization should be used for Y polarization as well.
Further details	See section Pulse Shaping on page 98.
Example	Command: :OMG:PULS:SAME 1 Query: :OMG:PULS:SAME?

:OMG:PULSeshaper:DSP:FIR:CGAin[?]

RequiredOption	#OSP
Command	:OMG:PULS:DSP:FIR:CGA[?]
Long	:OMG:PULSeshaper:DSP:FIR:CGAin[?]
Parameters	Numeric value
Description	Set or query the common gain value for the pulse shaper DSP stage. Only available in Real-time mode.
Further details	See section Pulse Shaping on page 98.
Example	Command: :OMG:PULS:DSP:FIR:CGA 1 Query: :OMG:PULS:DSP:FIR:CGA?

:OMG:PULSeshaper:X|Y:FILE[?]

RequiredOption	#OSP
Command	:OMG:PULS:X Y:FILE[?]
Long	:OMG:PULSeshaper:X Y:FILE[?]
Parameters	String value
Description	Set or query the filename to be used for the respective channel if the pulse shaping filter function is set to user-defined. File needs to be located either on the PC that the 81195A OMG software is running on or on a network location, accessible by that PC.
Further details	See section Pulse Shaping on page 98.
Example	Command: :OMG:PULS:X:FILE '<filename>' Query: :OMG:PULS:X:FILE?

:OMG:PULSeshaper:X|Y:FILTer[?]

Command	:OMG:PULS:X Y:FILT[?]
Long	:OMG:PULSeshaper:X Y:FILTer[?]
Parameters	RRC RC GAUSS RECT USER (enclosed in single or double quotes) (USER requires option #OSP)
Description	Set or query the pulse shaping filter function used for the respective channel.
Further details	See section Pulse Shaping on page 98.
Example	Command: :OMG:PULS:X:FILT 'RRC' Query: :OMG:PULS:X:FILT?

:OMG:PULSeshaper:X|Y:ROLLoff[?]

Command	:OMG:PULS:X Y:ROLL[?]
Long	:OMG:PULSeshaper:X Y:ROLLoff[?]
Parameters	Numeric value
Description	Set or query the pulse shaping filter function used for the respective channel.
Further details	See section Pulse Shaping on page 98.
Example	Command: :OMG:PULS:X:ROLL 0.35 Query: :OMG:PULS:X:ROLL?

SETTings Subsystem

This subsystem has the following commands:

Table 19

Name	Description under
:OMG:SETTings:ALL:DEfault	:OMG:SETTings:ALL:DEfault on page 194
:OMG:SETTings:ALL:LOAD	:OMG:SETTings:ALL:LOAD on page 195
:OMG:SETTings:ALL:SAVE	:OMG:SETTings:ALL:SAVE on page 195
:OMG:SETTings:PHASenoise:LOAD	:OMG:SETTings:PHASenoise:LOAD on page 195
:OMG:SETTings:PHASenoise:SAVE	:OMG:SETTings:PHASenoise:SAVE on page 196
:OMG:SETTings:PMD:LOAD	:OMG:SETTings:PMD:LOAD on page 196
:OMG:SETTings:PMD:SAVE	:OMG:SETTings:PMD:SAVE on page 196
:OMG:SETTings:POLarization:LOAD	:OMG:SETTings:POLarization:LOAD on page 197
:OMG:SETTings:POLarization:SAVE	:OMG:SETTings:POLarization:SAVE on page 197
:OMG:SETTings:WAVEform:LOAD	:OMG:SETTings:WAVEform:LOAD on page 198
:OMG:SETTings:WAVEform:SAVE	:OMG:SETTings:WAVEform:SAVE on page 198

:OMG:SETTings:ALL:DEfault

Command	:OMG:SETT:ALL:DEF
Long	:OMG:SETTings:ALL:DEfault
Parameters	None
Description	Reset all 81195A OMG software settings to default values.
Further details	See section File on page 49.
Example	Command: :OMG:SETT:ALL:DEF

:OMG:SETTings:ALL:LOAD

Command	:OMG:SETT:ALL:LOAD
Long	:OMG:SETTings:ALL:LOAD
Parameters	String value
Description	Load complete set of 81195A OMG software settings.
Further details	See section File on page 49.
Example	Command: :OMG:SETT:ALL:LOAD '<filename>'

:OMG:SETTings:ALL:SAVE

Command	:OMG:SETT:ALL:SAVE
Long	:OMG:SETTings:ALL:SAVE
Parameters	String value
Description	Save complete set of 81195A OMG software settings.
Further details	See section File on page 49.
Example	Command: :OMG:SETT:ALL:SAVE '<filename>'

:OMG:SETTings:PHASnoise:LOAD

Required Option	#OSP
Command	:OMG:SETT:PHAS:LOAD
Long	:OMG:SETTings:PHASnoise:LOAD
Parameters	String value
Description	Load subset of 81195A OMG software phase noise settings.
Further details	See section File on page 49.
Example	Command: :OMG:SETT:PHAS:LOAD '<filename>'

:OMG:SETTings:PHASnoise:SAVE

Required Option	#OSP
Command	:OMG:SETT:PHAS:SAVE
Long	:OMG:SETTings:PHASnoise:SAVE
Parameters	String value
Description	Save subset of 81195A OMG software phase noise settings.
Further details	See section File on page 49.
Example	Command: :OMG:SETT:PHAS:SAVE '<filename>'

:OMG:SETTings:PMD:LOAD

Required Option	#OSP
Command	:OMG:SETT:PMD:LOAD
Long	:OMG:SETTings:PMD:LOAD
Parameters	String value
Description	Load subset of 81195A OMG software PMD settings.
Further details	See section File on page 49.
Example	Command: :OMG:SETT:PMD:LOAD '<filename>'

:OMG:SETTings:PMD:SAVE

Required Option	#OSP
Command	:OMG:SETT:PMD:SAVE
Long	:OMG:SETTings:PMD:SAVE
Parameters	String value
Description	Save subset of 81195A OMG software PMD settings.
Further details	See section File on page 49.

Example Command
 :OMG:SETT:PMD:SAVE '<filename>'

:OMG:SETTings:POLarization:LOAD

Required Option #OSP
 Command :OMG:SETT:POL:LOAD
 Long :OMG:SETTings:POLarization:LOAD
 Parameters String value
 Description Load subset of 81195A OMG software polarization settings.
 Further details See section [File](#) on page 49.
 Example Command:
 :OMG:SETT:POL:LOAD '<filename>'

:OMG:SETTings:POLarization:SAVE

Required Option #OSP
 Command :OMG:SETT:POL:SAVE
 Long :OMG:SETTings:POLarization:SAVE
 Parameters String value
 Description Save subset of 81195A OMG software polarization settings.
 Further details See section [File](#) on page 49.
 Example Command:
 :OMG:SETT:POL:SAVE '<filename>'

:OMG:SETTings:WAVeform:LOAD

Required Option	#OSP
Command	:OMG:SETT:WAV:LOAD
Long	:OMG:SETTings:WAVeform:LOAD
Parameters	String value
Description	Load subset of 81195A OMG software waveform settings.
Further details	See section File on page 49.
Example	Command: :OMG:SETT:WAV:LOAD '<filename>'

:OMG:SETTings:WAVeform:SAVE

Required Option	#OSP
Command	:OMG:SETT:WAV:SAVE
Long	:OMG:SETTings:WAVeform:SAVE
Parameters	String value
Description	Save subset of 81195A OMG software waveform settings.
Further details	See section File on page 49.
Example	Command: :OMG:SETT:WAV:SAVE '<filename>'

SETup Subsystem

This subsystem has the following commands:

Table 20

Name	Description under
:OMG:SETup:AMODEl[?]	:OMG:SETup:AMODEl[?] on page 202
:OMG:SETup:MCONfig[?]	:OMG:SETup:MCONfig[?] on page 202
:OMG:SETup:MMODEl[?]	:OMG:SETup:MMODEl[?] on page 203
:OMG:SETup:CLOCK:SAMPLingrate[?]	:OMG:SETup:CLOCK:SAMPLingrate[?] on page 203
:OMG:SETup:CLOCK:SET	:OMG:SETup:CLOCK:SET on page 204
:OMG:SETup:CLOCK:SOURce[?]	:OMG:SETup:CLOCK:SOURce[?] on page 204
:OMG:SETup:CLOCK:REFeRence:RANGe[?]	:OMG:SETup:CLOCK:REFeRence:RANGe[?] on page 204
:OMG:SETup:CLOCK:REFeRence:RATE[?]	:OMG:SETup:CLOCK:REFeRence:RATE[?] on page 205
:OMG:SETup:INSTruments:MCONfig[?]	:OMG:SETup:INSTruments:MCONfig[?] on page 205
:OMG:SETup:INSTruments:RSTVisa	:OMG:SETup:INSTruments:RSTVisa on page 205
:OMG:SETup:INSTruments:MODule1 2 3 4:ADDReSS[?]	:OMG:SETup:INSTruments:MODule1 2 3 4:ADDReSS[?] on page 206
:OMG:SETup:INSTruments:VSA:ADDReSS[?]	:OMG:SETup:INSTruments:VSA:ADDReSS[?] on page 206
:OMG:SETup:MODule1 2 3 4:AVAIlable?	:OMG:SETup:MODule1 2 3 4:AVAIlable? on page 207
:OMG:SETup:MODule1 2 3 4:OPTions?	:OMG:SETup:MODule1 2 3 4:OPTions? on page 207
:OMG:SETup:MODule1 2 3 4:SLOT?	:OMG:SETup:MODule1 2 3 4:SLOT? on page 207
:OMG:SETup:MODule1 2 3 4:SNUMber?	:OMG:SETup:MODule1 2 3 4:SNUMber? on page 208
:OMG:SETup:SCLOCK:FREQUency[?]	:OMG:SETup:SCLOCK:FREQUency[?] on page 208
:OMG:SETup:SMODule:AVAIlable?	:OMG:SETup:SMODule:AVAIlable? on page 208
:OMG:SETup:SMODule:SNUMber?	:OMG:SETup:SMODule:SNUMber? on page 209
:OMG:SETup:TRIGger:IMPairment:SEND	:OMG:SETup:TRIGger:IMPairment:SEND on page 209
:OMG:SETup:TRIGger:IMPairment:SET	:OMG:SETup:TRIGger:IMPairment:SET on page 209
:OMG:SETup:TRIGger:IMPairment:OUTPut:ENABle[?]	:OMG:SETup:TRIGger:IMPairment:OUTPut:ENABle[?] on page 210

Name	Description under
:OMG:SETup:TRIGger:IMPairment:OUTPut:LEVel:HIGH[?]	:OMG:SETup:TRIGger:IMPairment:OUTPut:LEVel:HIGH[?] on page 210
:OMG:SETup:TRIGger:IMPairment:OUTPut:LEVel:LOW[?]	:OMG:SETup:TRIGger:IMPairment:OUTPut:LEVel:LOW[?] on page 211
:OMG:SETup:TRIGger:IMPairment:PHASenise:ROTator2:CONTInuous:ENABLE[?]	:OMG:SETup:TRIGger:IMPairment:PHASenise:ROTator2:CONTInuous:ENABLE[?] on page 211
:OMG:SETup:TRIGger:IMPairment:PHASenise:ROTator2:INPut:ENABLE[?]	:OMG:SETup:TRIGger:IMPairment:PHASenise:ROTator2:INPut:ENABLE[?] on page 212
:OMG:SETup:TRIGger:IMPairment:PHASenise:ROTator2:RETRigger:ENABLE[?]	:OMG:SETup:TRIGger:IMPairment:PHASenise:ROTator2:RETRigger:ENABLE[?] on page 212
:OMG:SETup:TRIGger:IMPairment:PHASenise:ROTator2:SOFTware:ENABLE[?]	:OMG:SETup:TRIGger:IMPairment:PHASenise:ROTator2:SOFTware:ENABLE[?] on page 212
:OMG:SETup:TRIGger:IMPairment:PHASenise:ROTator2:TOUT:ENABLE[?]	:OMG:SETup:TRIGger:IMPairment:PHASenise:ROTator2:TOUT:ENABLE[?] on page 213
:OMG:SETup:TRIGger:IMPairment:PHASenise:ROTator2:TOUT:ENABLE[?]	:OMG:SETup:TRIGger:IMPairment:PHASenise:ROTator2:TOUT:ENABLE[?] on page 213
:OMG:SETup:TRIGger:IMPairment:PHASenise:ROTator2:WAVEform:ENABLE[?]	:OMG:SETup:TRIGger:IMPairment:PHASenise:ROTator2:WAVEform:ENABLE[?] on page 213
:OMG:SETup:TRIGger:IMPairment:POLarization:CONTroll er1:INPut:ENABLE[?]	:OMG:SETup:TRIGger:IMPairment:POLarization:CONTroll er1:INPut:ENABLE[?] on page 214
:OMG:SETup:TRIGger:IMPairment:POLarization:CONTroll er1:CONTInuous:ENABLE[?]	:OMG:SETup:TRIGger:IMPairment:POLarization:CONTroll er1:CONTInuous:ENABLE[?] on page 214
:OMG:SETup:TRIGger:IMPairment:POLarization:CONTroll er1:RETRigger:ENABLE[?]	:OMG:SETup:TRIGger:IMPairment:POLarization:CONTroll er1:RETRigger:ENABLE[?] on page 215
:OMG:SETup:TRIGger:IMPairment:POLarization:CONTroll er1:SOFTware:ENABLE[?]	:OMG:SETup:TRIGger:IMPairment:POLarization:CONTroll er1:SOFTware:ENABLE[?] on page 215
:OMG:SETup:TRIGger:IMPairment:POLarization:CONTroll er1:WAVEform:ENABLE[?]	:OMG:SETup:TRIGger:IMPairment:POLarization:CONTroll er1:WAVEform:ENABLE[?] on page 216
:OMG:SETup:TRIGger:IMPairment:POLarization:CONTroll er2:CONTInuous:ENABLE[?]	:OMG:SETup:TRIGger:IMPairment:POLarization:CONTroll er2:CONTInuous:ENABLE[?] on page 217
:OMG:SETup:TRIGger:IMPairment:POLarization:CONTroll er2:INPut:ENABLE[?]	:OMG:SETup:TRIGger:IMPairment:POLarization:CONTroll er2:INPut:ENABLE[?] on page 217
:OMG:SETup:TRIGger:IMPairment:POLarization:CONTroll er2:RETRigger:ENABLE[?]	:OMG:SETup:TRIGger:IMPairment:POLarization:CONTroll er2:RETRigger:ENABLE[?] on page 218

Name	Description under
:OMG:SETup:TRIGger:IMPairment:POLarization:CONTRoller2:SOFTWARE:ENABLE[?]	:OMG:SETup:TRIGger:IMPairment:POLarization:CONTRoller2:SOFTWARE:ENABLE[?] on page 218
:OMG:SETup:TRIGger:IMPairment:POLarization:CONTRoller2:TOUT:ENABLE[?]	:OMG:SETup:TRIGger:IMPairment:POLarization:CONTRoller2:TOUT:ENABLE[?] on page 219
:OMG:SETup:TRIGger:IMPairment:POLarization:CONTRoller2:WAVEform:ENABLE[?]	:OMG:SETup:TRIGger:IMPairment:POLarization:CONTRoller2:WAVEform:ENABLE[?] on page 219
:OMG:SETup:TRIGger:SOFTWARE:TOUT:ENABLE[?]	:OMG:SETup:TRIGger:SOFTWARE:TOUT:ENABLE[?] on page 220
:OMG:SETup:TRIGger:WAVEform:FORCE	:OMG:SETup:TRIGger:WAVEform:FORCE on page 220
:OMG:SETup:TRIGger:WAVEform:MODE[?]	:OMG:SETup:TRIGger:WAVEform:MODE[?] on page 220
:OMG:SETup:TRIGger:WAVEform:SET	:OMG:SETup:TRIGger:WAVEform:SET on page 221
:OMG:SETup:TRIGger:WAVEform:SOURCE[?]	:OMG:SETup:TRIGger:WAVEform:SOURCE[?] on page 221
:OMG:SETup:TRIGger:WAVEform:INPUT:LEVEL[?]	:OMG:SETup:TRIGger:WAVEform:INPUT:LEVEL[?] on page 222
:OMG:SETup:TRIGger:WAVEform:INPUT:OPERation[?]	:OMG:SETup:TRIGger:WAVEform:INPUT:OPERation[?] on page 222
:OMG:SETup:TRIGger:WAVEform:INPUT:OPERation[?]	:OMG:SETup:TRIGger:WAVEform:INPUT:OPERation[?] on page 222
:OMG:SETup:TRIGger:WAVEform:INPUT:SLOPe[?]	:OMG:SETup:TRIGger:WAVEform:INPUT:SLOPe[?] on page 222
:OMG:SETup:TRIGger:WAVEform:INTERNAL:FREQuency[?]	:OMG:SETup:TRIGger:WAVEform:INTERNAL:FREQuency[?] on page 223
:OMG:SETup:TRIGger:WAVEform:INTERNAL:FREQuency[?]	:OMG:SETup:TRIGger:WAVEform:INTERNAL:FREQuency[?] on page 223
:OMG:SETup:TRIGger:WAVEform:TOUT:ENABLE[?]	:OMG:SETup:TRIGger:WAVEform:TOUT:ENABLE[?] on page 223

:OMG:SETup:AMODel[?]

Command	:OMG:SET:AMOD[?]
Long	:OMG:SETup:AMODel[?]
Parameters	M8194A M8195A M8196A VSA (enclosed in single or double quotes)
Description	Select the AWG model type used (Different hardware type or pure software operation (Load Waveform in VSA)). Depending on this selection, certain settings or operations may be restricted or disabled (e.g., Real-time operation or Memory Mode selection).
Further details	See section Basic Setup on page 158.
Example	Command: :OMG:SET:AMOD 'M8195A' Query: :OMG:SET:AMOD?

:OMG:SETup:MCONfig[?]

Command	:OMG:SET:MCON[?]
Long	:OMG:SETup:MCONfig[?]
Parameters	DUAL SINGle MDUAL MSINGle (enclosed in single or double quotes)
Description	Set or query whether to use one or two IQ pairs and whether to use one or multiple AWG modules. The latter applies to M8195A only.
Further details	See section Basic Setup on page 158
Example	Command: :OMG:SET:MCON 'DUAL' Query: :OMG:SET:MCON?

:OMG:SETup:MMODE[?]

Command	:OMG:SET:MMOD[?]
Long	:OMG:SETup:MMODE[?]
Parameters	INTernal EXTended (enclosed in single or double quotes)
Description	Set or query the AWG memory mode. Depending on the module configuration and the Waveform/Real-time selection, only a single option may be available.
Further details	See section Basic Setup on page 158

Example Command:
:OMG:SET:MMOD 'INT'
Query:
:OMG:SET:MMOD?

:OMG:SETup:CLOCK:SAMPLingrate[?]

Command	:OMG:SET:CLOC:SAMPL[?]
Long	:OMG:SETup:CLOCK:SAMPLingrate[?]
Parameters	Numeric value
Description	Set or query the AWG DAC sampling rate to be used. Will be applied to the instrument(s) the next time waveform / symbol data is sent to the instrument or when specific set command is executed.
Further details	See section Clock Setup on page 61.

Example Command:
:OMG:SET:CLOC:SAMPL 64E9
Query:
:OMG:SET:CLOC:SAMPL?

:OMG:SETup:CLOCK:SET

Command	:OMG:SET:CLOC:SET
Long	:OMG:SETup:CLOCK:SET
Parameters	None
Description	Apply current settings to instrument(s).
Further details	See section Clock Setup on page 61.
Example	Command: :OMG:SET:CLOC:SET

:OMG:SETup:CLOCK:SOURce[?]

Command	:OMG:SET:CLOC:SOUR[?]
Long	:OMG:SETup:CLOCK:SOURce[?]
Parameters	INTernal CLKin AXI (enclosed in single or double quotes)
Description	Set or query the clock source.
Further details	See section Clock Setup on page 61.
Example	Command: :OMG:SET:CLOC:SOUR 'INT' Query: :OMG:SET:CLOC:SOUR?

:OMG:SETup:CLOCK:REFerence:RANGe[?]

Command	:OMG:SET:CLOC:REF:RANG[?]
Long	:OMG:SETup:CLOCK:REFerence:RANGe[?]
Parameters	LOW HIGH NARRow (enclosed in single or double quotes)
Description	Set or query the reference clock input range. Certain settings are only available for specific type of instrument.
Further details	See section Clock Setup on page 61.
Example	Command: :OMG:SET:CLOC:REF:RANG 'LOW'

Query:

:OMG:SET:CLOC:REF:RANG?

:OMG:SETup:CLOCK:REFerence:RATE[?]

Command	:OMG:SET:CLOC:REF:RATE[?]
Long	:OMG:SETup:CLOCK:REFerence:RATE[?]
Parameters	Numeric value
Description	Set or query the reference clock input rate. Must be confined to selected reference clock input range.
Further details	See section Clock Setup on page 61.
Example	Command: :OMG:SET:CLOC:REF:RATE 100E6 Query: :OMG:SET:CLOC:REF:RATE?

:OMG:SETup:INSTruments:MCONfig[?]

Command	:OMG:SET:INST:MCON[?]
Long	:OMG:SETup:INSTruments:MCONfig[?]
Parameters	SINGLE MULTI (enclosed in single or double quotes)
Description	Set or query the module configuration mode (single module or multiple modules)
Further details	See section Instrument VISA setup on page 55.
Example	Command: :OMG:SET:INST:MCON 'SING' Query: :OMG:SET:INST:MCON?

:OMG:SETup:INSTruments:RSTVisa

Command :OMG:SET:INST:RSTV

Long	:OMG:SETup:INSTruments:RSTVisa
Parameters	None
Description	Resets all VISA connections currently used by the 81195A OMG software.
Further details	See section Instrument VISA setup on page 55.
Example	Command: :OMG:SET:INST:RSTV

:OMG:SETup:INSTruments:MODule1|2|3|4:ADDRess[?]

Command	:OMG:SET:INST:MOD1 2 3 4:ADDR[?]
Long	:OMG:SETup:INSTruments:MODule1 2 3 4:ADDRess[?]
Parameters	String value
Description	Set or query the VISA address of the respective AWG module, i.e., its respective Soft Front Panel instance.
Further details	See section Instrument VISA setup on page 55.
Example	Command: :OMG:SET:INST:MOD1:ADDR 'TCPIP0::localhost::hislip0::INSTR' Query: :OMG:SET:INST:MOD1:ADDR?

:OMG:SETup:INSTruments:VSA:ADDRess[?]

Command	:OMG:SET:INST:VSA:ADDR[?]
Long	:OMG:SETup:INSTruments:VSA:ADDRess[?]
Parameters	String value
Description	Set or query the VISA address of the VSA software.
Further details	See section Instrument VISA setup on page 55.
Example	Command: :OMG:SET:INST:VSA:ADDR 'TCPIP0::localhost::5026::SOCKET' Query: :OMG:SET:INST:VSA:ADDR?

:OMG:SETup:MODUle1|2|3|4:AVAIlable?

Command	:OMG:SET:MOD1 2 3 4:AVA?
Long	:OMG:SETup:MODUle1 2 3 4:AVAIlable?
Parameters	None
Description	Query whether the respective AWG module is available. Requires Verify Setup to be performed first.
Further details	See section Basic Setup on page 158.
Example	Command: :OMG:SET:MOD1:AVA?

:OMG:SETup:MODUle1|2|3|4:OPTions?

Command	:OMG:SET:MOD1 2 3 4:OPT?
Long	:OMG:SETup:MODUle1 2 3 4:OPTions?
Parameters	None
Description	Query the instrument options of the respective AWG module. Requires Verify Setup to be performed first.
Further details	See section Basic Setup on page 158.
Example	Command: :OMG:SET:MOD1:OPT?

:OMG:SETup:MODUle1|2|3|4:SLOT?

Command	:OMG:SET:MOD1 2 3 4:SLOT?
Long	:OMG:SETup:MODUle1 2 3 4:SLOT?
Parameters	None
Description	Query the slot number of the respective AWG module. Requires Verify Setup to be performed first.
Further details	See section Basic Setup on page 158.
Example	Command:

:OMG:SET:MOD1:SLOT?

:OMG:SETup:MODule1|2|3|4:SNUMber?

Command :OMG:SET:MOD1|2|3|4:SNUM?

Long :OMG:SETup:MODule1|2|3|4:SNUMBER?

Parameters None

Description Query the serial number of the respective AWG module. Requires Verify Setup to be performed first.

See section [Basic Setup](#) on page 158.

Example Command:

:OMG:SET:MOD1:SNUM?

:OMG:SETup:SCLock:FREQuency[?]

Command :OMG:SET:SCL:FREQ[?]

Long :OMG:SETup:SCLock:FREQuency[?]

Parameters Numeric value

Description Set or query the frequency of the sinusoidal signal that may be applied to individual AWG channels instead of the generated waveform. Not available in Real-time mode.

Further details See section [Basic Setup](#) on page 158.

Example Command:

:OMG:SET:SCL:FREQ 4E9

Query:

:OMG:SET:SCL:FREQ?

:OMG:SETup:SMODule:AVAIlable?

Command :OMG:SET:SMOD:AVA?

Long :OMG:SETup:SMODule:AVAIlable?

Parameters None

Description Query whether the synchronization module is available. Requires Verify Setup to be performed first.

Further details See section [Basic Setup](#) on page 158.

Example Command:
:OMG:SET:SMOD:AVA?

:OMG:SETup:SMODule:SNUMber?

Command :OMG:SET:SMOD:SNUM?

Long :OMG:SETup:SMODule:SNUMber?

Parameters None

Description Query the serial number of the synchronization module. Requires Verify Setup to be performed first.

Further details See section [Basic Setup](#) on page 158.

Example Command:
:OMG:SET:SMOD:SNUM?

:OMG:SETup:TRIGger:IMPairment:SEND

Required Option #RSP

Command :OMG:SET:TRIG:IMP:SEND

Long :OMG:SETup:TRIGger:IMPairment:SEND

Parameters None

Description Send a software trigger to the instrument.

Further details See section [Trigger Setup](#) on page 64.

Example Command:
:OMG:SET:TRIG:IMP:SEND

:OMG:SETup:TRIGger:IMPairment:SET

Required Option #RSP

Command :OMG:SET:TRIG:IMP:SET

Long :OMG:SETup:TRIGger:IMPairment:SET
 Parameters None
 Description Apply current impairment trigger settings to instrument(s).
 Further details See section [Trigger Setup](#) on page 64.
 Example Command:
 :OMG:SET:TRIG:IMP:SET

:OMG:SETup:TRIGger:IMPairment:OUTPut:ENABle[?]

Required Option #RSP
 Command :OMG:SET:TRIG:IMP:OUTP:ENAB[?]
 Long :OMG:SETup:TRIGger:IMPairment:OUTPut:ENABle[?]
 Parameters 0|1
 Description Set or query whether output trigger is enabled.
 Further details See section [Trigger Setup](#) on page 64.
 Example Command:
 :OMG:SET:TRIG:IMP:OUTP:ENAB 0
 Query:
 :OMG:SET:TRIG:IMP:OUTP:ENAB?

:OMG:SETup:TRIGger:IMPairment:OUTPut:LEVel:HIGH[?]

Required Option #RSP
 Command :OMG:SET:TRIG:IMP:OUTP:LEV:HIGH[?]
 Long :OMG:SETup:TRIGger:IMPairment:OUTPut:LEVel:HIGH[?]
 Parameters Numeric value
 Description Set or query the output trigger high level.
 Further details See section [Trigger Setup](#) on page 64.
 Example Command:
 :OMG:SET:TRIG:IMP:OUTP:LEV:HIGH 0.25
 Query:

:OMG:SET:TRIG:IMP:OUTP:LEV:HIGH?

:OMG:SETup:TRIGger:IMPairment:OUTPut:LEVel:LOW[?]

Required Option	#RSP
Command	:OMG:SET:TRIG:IMP:OUTP:LEV:LOW[?]
Long	:OMG:SETup:TRIGger:IMPairment:OUTPut:LEVel:LOW[?]
Parameters	Numeric value
Description	Set or query the output trigger low level.
Further details	See section Trigger Setup on page 64.
Example	Command: :OMG:SET:TRIG:IMP:OUTP:LEV:LOW -0.25 Query: :OMG:SET:TRIG:IMP:OUTP:LEV:LOW?

:OMG:SETup:TRIGger:IMPairment:PHASnoise:ROTator2:CONTInuous:ENABle[?]

Required Option	#RSP
Command	:OMG:SET:TRIG:IMP:PHAS:ROT2:CONT:ENAB[?]
Long	:OMG:SETup:TRIGger:IMPairment:PHASnoise:ROTator2:CONTInuous:ENABle[?]
Parameters	0 1
Description	Set or query whether the instrument's phase noise stage is going to repeat patterns continuously or just once. Not applicable in waveform mode.
Further details	See section Trigger Setup on page 64.
Example	Command: :OMG:SET:TRIG:IMP:PHAS:ROT2:CONT:ENAB 1 Query: :OMG:SET:TRIG:IMP:PHAS:ROT2:CONT:ENAB?

:OMG:SETup:TRIGger:IMPairment:PHASenoiSe:ROtator2:INPut:ENABle[?]

Required Option	#RSP
Command	:OMG:SET:TRIG:IMP:PHAS:ROT2:INP:ENAB[?]
Long	:OMG:SETup:TRIGger:IMPairment:PHASenoiSe:ROtator2:INPut:ENABle[?]
Parameters	0 1
Description	Set or query whether the instrument's phase noise stage is to be triggered by pulses at the TRIG IN front panel connector. Not applicable in waveform mode.
Further details	See section Trigger Setup on page 64.
Example	Command: :OMG:SET:TRIG:IMP:PHAS:ROT2:INP:ENAB 0 Query: :OMG:SET:TRIG:IMP:PHAS:ROT2:INP:ENAB?

:OMG:SETup:TRIGger:IMPairment:PHASenoiSe:ROtator2:RETRigger:ENABle[?]

Required Option	#RSP
Command	:OMG:SET:TRIG:IMP:PHAS:ROT2:RETR:ENAB[?]
Long	:OMG:SETup:TRIGger:IMPairment:PHASenoiSe:ROtator2:RETRigger:ENABle[?]
Parameters	0 1
Description	Set or query whether the instrument's phase noise stage is allowed to be triggered repeatedly. Not applicable in waveform mode.
Further details	See section Trigger Setup on page 64.
Example	Command: :OMG:SET:TRIG:IMP:PHAS:ROT2:RETR:ENAB 1 Query: :OMG:SET:TRIG:IMP:PHAS:ROT2:RETR:ENAB?

:OMG:SETup:TRIGger:IMPairment:PHASenoiSe:ROtator2:SOFTware:ENABle[?]

Required Option	#RSP
-----------------	------

Command	:OMG:SET:TRIG:IMP:PHAS:ROT2:SOFT:ENAB[?]
Long	:OMG:SETup:TRIGger:IMPairment:PHASenoiSe:ROTator2:SOFTware:ENABle[?]
Parameters	0 1
Description	Set or query whether the instrument's phase noise stage is to be triggered by the software trigger. Not applicable in waveform mode.
Further details	See section Trigger Setup on page 64.
Example	Command: :OMG:SET:TRIG:IMP:PHAS:ROT2:SOFT:ENAB 0 Query: :OMG:SET:TRIG:IMP:PHAS:ROT2:SOFT:ENAB?

:OMG:SETup:TRIGger:IMPairment:PHASenoiSe:ROTator2:TOUT:ENABle[?]

Required Option	#RSP
Command	:OMG:SET:TRIG:IMP:PHAS:ROT2:TOUT:ENAB[?]
Long	:OMG:SETup:TRIGger:IMPairment:PHASenoiSe:ROTator2:TOUT:ENABle[?]
Parameters	0 1
Description	Set or query whether the instrument's phase noise stage triggers generate an output trigger. Only a single output trigger source may be selected. Not applicable in waveform mode.
Further details	See section Trigger Setup on page 64.
Example	Command: :OMG:SET:TRIG:IMP:PHAS:ROT2:TOUT:ENAB 0 Query: :OMG:SET:TRIG:IMP:PHAS:ROT2:TOUT:ENAB?

:OMG:SETup:TRIGger:IMPairment:PHASenoiSe:ROTator2:WAVEform:ENABle[?]

Required Option	#RSP
Command	:OMG:SET:TRIG:IMP:PHAS:ROT2:WAV:ENAB[?]

Long	:OMG:SETup:TRIGger:IMPairment:PHASenoise:ROTator2:WAVEform:ENABLE[?]
Parameters	0 1
Description	Set or query whether the instrument's phase noise stage is to be triggered by the waveform trigger. Not applicable in waveform mode.
Further details	See section Trigger Setup on page 64.
Example	Command: :OMG:SET:TRIG:IMP:PHAS:ROT2:WAV:ENAB 0 Query: :OMG:SET:TRIG:IMP:PHAS:ROT2:WAV:ENAB?

:OMG:SETup:TRIGger:IMPairment:POLarization:CONTroller1:INPut:ENABLE[?]

Required Option	#RSP
Command	:OMG:SET:TRIG:IMP:POL:CONT1:INP:ENAB[?]
Long	:OMG:SETup:TRIGger:IMPairment:POLarization:CONTroller1:INPut:ENABLE[?]
Parameters	0 1
Description	Set or query whether the instrument's first polarization controller stage is to be triggered by pulses at the TRIG IN front panel connector. Not applicable in waveform mode.
Further details	See section Trigger Setup on page 64.
Example	Command: :OMG:SET:TRIG:IMP:POL:CONT1:INP:ENAB 0 Query: :OMG:SET:TRIG:IMP:POL:CONT1:INP:ENAB?

:OMG:SETup:TRIGger:IMPairment:POLarization:CONTroller1:CONTInuous:ENABLE[?]

Required Option	#RSP
Command	:OMG:SET:TRIG:IMP:POL:CONT1:CONT:ENAB[?]
Long	:OMG:SETup:TRIGger:IMPairment:POLarization:CONTroller1:CONTInuous:ENABLE[?]

Parameters	0 1
Description	Set or query whether the instrument's first polarization controller stage is going to repeat patterns continuously or just once. Not applicable in waveform mode.
Further details	See section Trigger Setup on page 64.
Example	Command: :OMG:SET:TRIG:IMP:POL:CONT1:CONT:ENAB 1 Query: :OMG:SET:TRIG:IMP:POL:CONT1:CONT:ENAB?

:OMG:SETup:TRIGger:IMPairment:POLarization:CONTroller1:RETRigger:ENABLE[?]

Required Option	#RSP
Command	:OMG:SET:TRIG:IMP:POL:CONT1:RETR:ENAB[?]
Long	:OMG:SETup:TRIGger:IMPairment:POLarization:CONTroller1:RETRigger:ENABLE[?]
Parameters	0 1
Description	Set or query whether the instrument's first polarization controller stage is allowed to be triggered repeatedly. Not applicable in waveform mode.
Further details	See section Trigger Setup on page 64.
Example	Command: :OMG:SET:TRIG:IMP:POL:CONT1:RETR:ENAB 1 Query: :OMG:SET:TRIG:IMP:POL:CONT1:RETR:ENAB?

:OMG:SETup:TRIGger:IMPairment:POLarization:CONTroller1:SOFTWARE:ENABLE[?]

Required Option	#RSP
Command	:OMG:SET:TRIG:IMP:POL:CONT1:SOFT:ENAB[?]
Long	:OMG:SETup:TRIGger:IMPairment:POLarization:CONTroller1:SOFTWARE:ENABLE[?]
Parameters	0 1

Description	Set or query whether the instrument's first polarization controller stage is to be triggered by the software trigger. Not applicable in waveform mode.
Further details	See section Trigger Setup on page 64.
Example	Command: :OMG:SET:TRIG:IMP:POL:CONT1:SOFT:ENAB 0 Query: :OMG:SET:TRIG:IMP:POL:CONT1:SOFT:ENAB?

:OMG:SETup:TRIGger:IMPairment:POLarization:CONTroller1:TOUT:ENABLE[?]

Required Option	#RSP
Command	:OMG:SET:TRIG:IMP:POL:CONT1:TOUT:ENAB[?]
Long	:OMG:SETup:TRIGger:IMPairment:POLarization:CONTroller1:TOUT:ENABLE[?]
Parameters	0 1
Description	Set or query whether the instrument's first polarization controller stage triggers generate an output trigger. Only a single output trigger source may be selected. Not applicable in waveform mode.
Further details	See section Trigger Setup on page 64.
Example	Command: :OMG:SET:TRIG:IMP:POL:CONT1:TOUT:ENAB 0 Query: :OMG:SET:TRIG:IMP:POL:CONT1:TOUT:ENAB?

:OMG:SETup:TRIGger:IMPairment:POLarization:CONTroller1:WAVEform:ENABLE[?]

Required Option	#RSP
Command	:OMG:SET:TRIG:IMP:POL:CONT1:WAV:ENAB[?]
Long	:OMG:SETup:TRIGger:IMPairment:POLarization:CONTroller1:WAVEform:ENABLE[?]
Parameters	0 1
Description	Set or query whether the instrument's first polarization controller stage is to be triggered by the waveform trigger. Not applicable in waveform mode.

Further details See section [Trigger Setup](#) on page 64.

Example Command:
 :OMG:SET:TRIG:IMP:POL:CONT1:WAV:ENAB 0
 Query:
 :OMG:SET:TRIG:IMP:POL:CONT1:WAV:ENAB?

:OMG:SETup:TRIGger:IMPairment:POLarization:CONTroller2:CONTinuous:ENABle[?]

Required Option #RSP
 Command :OMG:SET:TRIG:IMP:POL:CONT2:CONT:ENAB[?]
 Long :OMG:SETup:TRIGger:IMPairment:POLarization:CONTroller2:CONTinuous:ENABle[?]
 Parameters 0|1
 Description Set or query whether the instrument's second polarization controller stage is going to repeat patterns continuously or just once. Not applicable in waveform mode.

Further details See section [Trigger Setup](#) on page 64.

Example Command:
 :OMG:SET:TRIG:IMP:POL:CONT2:CONT:ENAB 1
 Query:
 :OMG:SET:TRIG:IMP:POL:CONT2:CONT:ENAB?

:OMG:SETup:TRIGger:IMPairment:POLarization:CONTroller2:INPut:ENABle[?]

Required Option #RSP
 Command :OMG:SET:TRIG:IMP:POL:CONT2:INP:ENAB[?]
 Long :OMG:SETup:TRIGger:IMPairment:POLarization:CONTroller2:INPut:ENABle[?]
 Parameters 0|1
 Description Set or query whether the instrument's second polarization controller stage is to be triggered by pulses at the TRIG IN front panel connector. Not applicable in waveform mode.

Further details See section [Trigger Setup](#) on page 64.

Example Command:
 :OMG:SET:TRIG:IMP:POL:CONT2:INP:ENAB 0
 Query:
 :OMG:SET:TRIG:IMP:POL:CONT2:INP:ENAB?

:OMG:SETup:TRIGger:IMPairment:POLarization:CONTroller2:RETRigger:ENABLE[?]

Required Option #RSP
 Command :OMG:SET:TRIG:IMP:POL:CONT2:RETR:ENAB[?]
 Long :OMG:SETup:TRIGger:IMPairment:POLarization:CONTroller2:RETRigger:ENAB[?]
 Parameters 0|1
 Description Set or query whether the instrument's second polarization controller stage is allowed to be triggered repeatedly. Not applicable in waveform mode.
 Further details See section [Trigger Setup](#) on page 64.
 Example Command:
 :OMG:SET:TRIG:IMP:POL:CONT2:RETR:ENAB 1
 Query:
 :OMG:SET:TRIG:IMP:POL:CONT2:RETR:ENAB?

:OMG:SETup:TRIGger:IMPairment:POLarization:CONTroller2:SOFTware:ENABLE[?]

Required Option #RSP
 Command :OMG:SET:TRIG:IMP:POL:CONT2:SOFT:ENAB[?]
 Long :OMG:SETup:TRIGger:IMPairment:POLarization:CONTroller2:SOFTware:ENAB[?]
 Parameters 0|1
 Description Set or query whether the instrument's second polarization controller stage is to be triggered by the software trigger. Not applicable in waveform mode.
 Further details See section [Trigger Setup](#) on page 64.
 Example Command:

```
:OMG:SET:TRIG:IMP:POL:CONT2:SOFT:ENAB 0
```

```
Query:
```

```
:OMG:SET:TRIG:IMP:POL:CONT2:SOFT:ENAB?
```

:OMG:SETup:TRIGger:IMPairment:POLarization:CONTroller2:TOUT:ENABLE[?]

Required Option	#RSP
Command	:OMG:SET:TRIG:IMP:POL:CONT2:TOUT:ENAB[?]
Long	:OMG:SETup:TRIGger:IMPairment:POLarization:CONTroller2:TOUT:ENAB[?]
Parameters	0 1
Description	Set or query whether the instrument's second polarization controller stage triggers generate an output trigger. Only a single output trigger source may be selected. Not applicable in waveform mode.
Further details	See section Trigger Setup on page 64.
Example	Command: :OMG:SET:TRIG:IMP:POL:CONT2:TOUT:ENAB 0 Query: :OMG:SET:TRIG:IMP:POL:CONT2:TOUT:ENAB?

:OMG:SETup:TRIGger:IMPairment:POLarization:CONTroller2:WAVEform:ENABLE[?]

Required Option	#RSP
Command	:OMG:SET:TRIG:IMP:POL:CONT2:WAV:ENAB[?]
Long	:OMG:SETup:TRIGger:IMPairment:POLarization:CONTroller2:WAVEform:ENAB[?]
Parameters	0 1
Description	Set or query whether the instrument's second polarization controller stage is to be triggered by the waveform trigger. Not applicable in waveform mode.
Further details	See section Trigger Setup on page 64.
Example	Command: :OMG:SET:TRIG:IMP:POL:CONT2:WAV:ENAB 0

Query:

:OMG:SET:TRIG:IMP:POL:CONT2:WAV:ENAB?

:OMG:SETup:TRIGger:SOFTware:TOUT:ENABLE[?]

Required Option #RSP

Command :OMG:SET:TRIG:SOFT:TOUT:ENAB[?]

Long :OMG:SETup:TRIGger:SOFTware:TOUT:ENABLE[?]

Parameters 0|1

Description Set or query whether software triggers generate an output trigger. Only a single output trigger source may be selected.

Further details See section [Trigger Setup](#) on page 64.

Example Command:

:OMG:SET:TRIG:SOFT:TOUT:ENAB 0

Query:

:OMG:SET:TRIG:SOFT:TOUT:ENAB?

:OMG:SETup:TRIGger:WAVeform:FORCe

Command :OMG:SET:TRIG:WAV:FORC

Long :OMG:SETup:TRIGger:WAVeform:FORCe

Parameters None

Description Force a waveform trigger on the instrument(s).

Further details See section [Trigger Setup](#) on page 64.

Example Command:

:OMG:SET:TRIG:WAV:FORC

:OMG:SETup:TRIGger:WAVeform:MODE[?]

Command :OMG:SET:TRIG:WAV:MODE[?]

Long :OMG:SETup:TRIGger:WAVeform:MODE[?]

Parameters CONTInuous|TRIGgered (enclosed in single or double quotes)

Description Set or query the waveform trigger mode.

Further details See section [Trigger Setup](#) on page 64.

Example Command:
:OMG:SET:TRIG:WAV:MODE 'CONT'
Query:
:OMG:SET:TRIG:WAV:MODE?

:OMG:SETup:TRIGger:WAVeform:SET

Command :OMG:SET:TRIG:WAV:SET

Long :OMG:SETup:TRIGger:WAVeform:SET

Parameters None

Description Apply current waveform trigger settings to instrument(s).

Further details See section [Trigger Setup](#) on page 64.

Example Command:
:OMG:SET:TRIG:WAV:SET

:OMG:SETup:TRIGger:WAVeform:SOURce[?]

Command :OMG:SET:TRIG:WAV:SOUR[?]

Long :OMG:SETup:TRIGger:WAVeform:SOURce[?]

Parameters TRIGger|INTernal (enclosed in single or double quotes)

Description Set or query the waveform trigger source.

Further details See section [Trigger Setup](#) on page 64.

Example Command:
:OMG:SET:TRIG:WAV:SOUR 'TRIG'
Query:
:OMG:SET:TRIG:WAV:SOUR?

:OMG:SETup:TRIGger:WAVeform:INPut:LEVel[?]

Command	:OMG:SET:TRIG:WAV:INP:LEV[?]
Long	:OMG:SETup:TRIGger:WAVeform:INPut:LEVel[?]
Parameters	Numeric value
Description	Set or query the waveform trigger threshold level.
Further details	See section Trigger Setup on page 64.
Example	Command: :OMG:SET:TRIG:WAV:INP:LEV 0.5 Query: :OMG:SET:TRIG:WAV:INP:LEV?

:OMG:SETup:TRIGger:WAVeform:INPut:OPERation[?]

Command	:OMG:SET:TRIG:WAV:INP:OPER[?]
Long	:OMG:SETup:TRIGger:WAVeform:INPut:OPERation[?]
Parameters	ASYNchronous SYNchronous (enclosed in single or double quotes)
Description	Set or query the waveform trigger operation.
Further details	See section Trigger Setup on page 64.
Example	Command: :OMG:SET:TRIG:WAV:INP:OPER 'ASYN' Query: :OMG:SET:TRIG:WAV:INP:OPER?

:OMG:SETup:TRIGger:WAVeform:INPut:SLOPe[?]

Command	:OMG:SET:TRIG:WAV:INP:SLOP[?]
Long	:OMG:SETup:TRIGger:WAVeform:INPut:SLOPe[?]
Parameters	POSitive NEGative EITHer (enclosed in single or double quotes)
Description	Set or query the waveform trigger slope.
Further details	See section Trigger Setup on page 64.
Example	Command:

:OMG:SET:TRIG:WAV:INP:SLOP 'POS'

Query:

:OMG:SET:TRIG:WAV:INP:SLOP?

:OMG:SETup:TRIGger:WAVeform:INTernal:FREQuency[?]

Command :OMG:SET:TRIG:WAV:INT:FREQ[?]

Long :OMG:SETup:TRIGger:WAVeform:INTernal:FREQuency[?]

Parameters Numeric value

Description Set or query the waveform trigger frequency used if waveform trigger mode is set to internal.

Further details See section [Trigger Setup](#) on page 64.

Example Command:

:OMG:SET:TRIG:WAV:INT:FREQ 1

Query:

:OMG:SET:TRIG:WAV:INT:FREQ?

:OMG:SETup:TRIGger:WAVeform:TOUT:ENABLE[?]

Required Option #RSP

Command :OMG:SET:TRIG:WAV:TOUT:ENAB[?]

Long :OMG:SETup:TRIGger:WAVeform:TOUT:ENABLE[?]

Parameters 0|1

Description Set or query whether waveform triggers generate an output trigger. Only a single output trigger source may be selected.

Further details See section [Trigger Setup](#) on page 64.

Example Command:

:OMG:SET:TRIG:WAV:TOUT:ENAB 0

Query:

:OMG:SET:TRIG:WAV:TOUT:ENAB?

SPRoperties Subsystem

This subnode has the following commands:

Table 21

Name	Description under
:OMG:SPRoperties:NLTRansfer:BYPass[?]	:OMG:SPRoperties:NLTRansfer:BYPass[?] on page 228
:OMG:SPRoperties:NLTRansfer:SAME[?]	:OMG:SPRoperties:NLTRansfer:SAME[?] on page 229
:OMG:SPRoperties:NLTRansfer:XI XQ YI YQ:FILE[?]	:OMG:SPRoperties:NLTRansfer:XI XQ YI YQ:FILE[?] on page 229
:OMG:SPRoperties:NLTRansfer:XI XQ YI YQ:FUNCTio n[?]	:OMG:SPRoperties:NLTRansfer:XI XQ YI YQ:FUNCTio n[?] on page 229
:OMG:SPRoperties:NLTRansfer:XI XQ YI YQ:RANGe[?]	:OMG:SPRoperties:NLTRansfer:XI XQ YI YQ:RANGe[?] on page 230
:OMG:SPRoperties:PHASenoiSe:PATtern:FILE[?]	:OMG:SPRoperties:PHASenoiSe:ROTator2:PATtern:FILE[?] on page 230
:OMG:SPRoperties:PHASenoiSe:ROTator2:BYPass[?]	:OMG:SPRoperties:PHASenoiSe:ROTator2:BYPass[?] on page 231
:OMG:SPRoperties:PHASenoiSe:ROTator2:CONStan t:RRATe[?]	:OMG:SPRoperties:PHASenoiSe:ROTator2:CONStan t:RRATe[?] on page 231
:OMG:SPRoperties:PHASenoiSe:ROTator2:CONStan t:ACTiVe[?]	:OMG:SPRoperties:PHASenoiSe:ROTator2:CONStan t:ACTiVe[?] on page 232
:OMG:SPRoperties:PHASenoiSe:ROTator2:CONStan t:FSHift[?]	:OMG:SPRoperties:PHASenoiSe:ROTator2:CONStan t:FSHift[?] on page 232
:OMG:SPRoperties:PHASenoiSe:ROTator2:PATtern: ACTiVe[?]	:OMG:SPRoperties:PHASenoiSe:ROTator2:PATtern:ACTiVe[?] on page 232
:OMG:SPRoperties:PHASenoiSe:ROTator2:PATtern: SDiVider[?]	:OMG:SPRoperties:PHASenoiSe:ROTator2:PATtern:SDiVider[?] on page 233
:OMG:SPRoperties:PHASenoiSe:ROTator2:PATtern: SOURce[?]	:OMG:SPRoperties:PHASenoiSe:ROTator2:PATtern:SOURce[?] on page 233
:OMG:SPRoperties:PHASenoiSe:ROTator2:PATtern: MODEl:FFNoiSe[?]	:OMG:SPRoperties:PHASenoiSe:ROTator2:PATtern:MODEl:FFNoiSe[?] on page 234
:OMG:SPRoperties:PHASenoiSe:ROTator2:PATtern: MODEl:FRWNoiSe[?]	:OMG:SPRoperties:PHASenoiSe:ROTator2:PATtern:MODEl:FRWNoiSe[?] on page 234
:OMG:SPRoperties:PHASenoiSe:ROTator2:PATtern: MODEl:FRWNoiSe[?]	:OMG:SPRoperties:PHASenoiSe:ROTator2:PATtern:MODEl:FRWNoiSe[?] on page 234

Name	Description under
:OMG:SPRoperties:PHASenoiSe:ROtator2:PATtern:MODEl:LINewidth[?]	:OMG:SPRoperties:PHASenoiSe:ROtator2:PATtern:MODEl:LINewidth[?] on page 235
:OMG:SPRoperties:PHASenoiSe:ROtator2:PATtern:MODEl:RANDomize	:OMG:SPRoperties:PHASenoiSe:ROtator2:PATtern:MODEl:RANDomize on page 235
:OMG:SPRoperties:PHASenoiSe:ROtator2:PATtern:MODEl:RANDomize	:OMG:SPRoperties:PHASenoiSe:ROtator2:PATtern:MODEl:RANDomize on page 235
:OMG:SPRoperties:PHASenoiSe:ROtator2:PATtern:MODEl:SEED[?]	:OMG:SPRoperties:PHASenoiSe:ROtator2:PATtern:MODEl:SEED[?] on page 235
:OMG:SPRoperties:PMD:BYPass[?]	:OMG:SPRoperties:PMD:BYPass[?] on page 236
:OMG:SPRoperties:PMD:DEPolarizati?	:OMG:SPRoperties:PMD:DEPolarizati? on page 236
:OMG:SPRoperties:PMD:MODE[?]	:OMG:SPRoperties:PMD:MODE[?] on page 237
:OMG:SPRoperties:PMD:PCD?	:OMG:SPRoperties:PMD:PCD? on page 237
:OMG:SPRoperties:PMD:PMD?	:OMG:SPRoperties:PMD:PMD? on page 238
:OMG:SPRoperties:PMD:PREDefined	:OMG:SPRoperties:PMD:PREDefined on page 238
:OMG:SPRoperties:PMD:RANDomize	:OMG:SPRoperties:PMD:RANDomize on page 238
:OMG:SPRoperties:PMD:SEED[?]	:OMG:SPRoperties:PMD:SEED[?] on page 239
:OMG:SPRoperties:PMD:SOPMd?	:OMG:SPRoperties:PMD:SOPMd? on page 239
:OMG:SPRoperties:PMD:DSP:FIR:CGAin[?]	:OMG:SPRoperties:PMD:DSP:FIR:CGAin[?] on page 239
:OMG:SPRoperties:PMD:FIR:FMODE:ACTIve[?]	:OMG:SPRoperties:PMD:FIR:FMODE:ACTIve[?] on page 240
:OMG:SPRoperties:PMD:FIR:FMODE:FILE[?]	:OMG:SPRoperties:PMD:FIR:FMODE:FILE[?] on page 240
:OMG:SPRoperties:PMD:PHASes:LINK[?]	:OMG:SPRoperties:PMD:PHASes:LINK[?] on page 241
:OMG:SPRoperties:PMD:SEGment1 2 ... 13 14:AXIS[?]*	:OMG:SPRoperties:PMD:SEGment1 2 ... 13 14:AXIS[?] on page 241
:OMG:SPRoperties:PMD:SEGment1 2 ... 13 14:ENABle[?]*	:OMG:SPRoperties:PMD:SEGment1 2 ... 13 14:ENABle[?] on page 242
:OMG:SPRoperties:PMD:SEGment1 2 ... 13 14:PHASe[?]*	:OMG:SPRoperties:PMD:SEGment1 2 ... 13 14:PHASe[?] on page 243
:OMG:SPRoperties:POLarization:MODE[?]	:OMG:SPRoperties:POLarization:MODE[?] on page 243
:OMG:SPRoperties:POLarization:MODE[?]	:OMG:SPRoperties:POLarization:MODE[?] on page 243
:OMG:SPRoperties:POLarization:COMBined:BYPass[?]	:OMG:SPRoperties:POLarization:COMBined:BYPass[?] on page 244

Name	Description under
:OMG:SPRoperties:POLarization:COMBined:BYPass[?]	:OMG:SPRoperties:POLarization:COMBined:BYPass[?] on page 244
:OMG:SPRoperties:POLarization:COMBined:INFO:SPeEd?	:OMG:SPRoperties:POLarization:COMBined:INFO:SPeEd? on page 244
:OMG:SPRoperties:POLarization:COMBined:INFO:STEP?	:OMG:SPRoperties:POLarization:COMBined:INFO:STEP? on page 244
:OMG:SPRoperties:POLarization:COMBined:PATTer n:FILE[?]	:OMG:SPRoperties:POLarization:COMBined:PATTer n:FILE[?] on page 245
:OMG:SPRoperties:POLarization:COMBined:PATTer n:LENGth[?]	:OMG:SPRoperties:POLarization:COMBined:PATTer n:LENGth[?] on page 245
:OMG:SPRoperties:POLarization:COMBined:PATTer n:LENGth[?]	:OMG:SPRoperties:POLarization:COMBined:PATTer n:LENGth[?] on page 245
:OMG:SPRoperties:POLarization:COMBined:PATTer n:RATio[?]	:OMG:SPRoperties:POLarization:COMBined:PATTer n:RATio[?] on page 246
:OMG:SPRoperties:POLarization:COMBined:PATTer n:SHIFt[?]	:OMG:SPRoperties:POLarization:COMBined:PATTer n:SHIFt[?] on page 247
:OMG:SPRoperties:POLarization:COMBined:PATTer n:SPeEd[?]	:OMG:SPRoperties:POLarization:COMBined:PATTer n:SPeEd[?] on page 247
:OMG:SPRoperties:POLarization:CONTRoller1 2:BYPass[?]	:OMG:SPRoperties:POLarization:CONTRoller1 2:BYPass[?] on page 247
:OMG:SPRoperties:POLarization:CONTRoller1 2:INFO:SPeEd?	:OMG:SPRoperties:POLarization:CONTRoller1 2:INFO:SPeEd? on page 248
:OMG:SPRoperties:POLarization:CONTRoller1 2:INFO:STEP?	:OMG:SPRoperties:POLarization:CONTRoller1 2:INFO:STEP? on page 248
:OMG:SPRoperties:POLarization:CONTRoller1 2:JONes:XXIMag[?]	:OMG:SPRoperties:POLarization:CONTRoller1 2:JONes:XXIMag[?] on page 249
:OMG:SPRoperties:POLarization:CONTRoller1 2:JONes:XYReal[?]	:OMG:SPRoperties:POLarization:CONTRoller1 2:JONes:XYReal[?] on page 250
:OMG:SPRoperties:POLarization:CONTRoller1 2:JONes:XYIMag[?]	:OMG:SPRoperties:POLarization:CONTRoller1 2:JONes:XYIMag[?] on page 250
:OMG:SPRoperties:POLarization:CONTRoller1 2:JONes:XYReal[?]	:OMG:SPRoperties:POLarization:CONTRoller1 2:JONes:XYReal[?] on page 250
:OMG:SPRoperties:POLarization:CONTRoller1 2:JONes:XYReal[?]	:OMG:SPRoperties:POLarization:CONTRoller1 2:JONes:XYReal[?] on page 250

Name	Description under
:OMG:SPRoperties:POLarization:CONTRoller1 2:JONes:YXIMag[?]	:OMG:SPRoperties:POLarization:CONTRoller1 2:JONes:YXIMag[?] on page 251
:OMG:SPRoperties:POLarization:CONTRoller1 2:JONes:YXReal[?]	:OMG:SPRoperties:POLarization:CONTRoller1 2:JONes:YXReal[?] on page 251
:OMG:SPRoperties:POLarization:CONTRoller1 2:JONes:YYIMag[?]	:OMG:SPRoperties:POLarization:CONTRoller1 2:JONes:YYIMag[?] on page 252
:OMG:SPRoperties:POLarization:CONTRoller1 2:JONes:YYIMag[?]	:OMG:SPRoperties:POLarization:CONTRoller1 2:JONes:YYIMag[?] on page 252
:OMG:SPRoperties:POLarization:CONTRoller1 2:JONes:YYReal[?]	:OMG:SPRoperties:POLarization:CONTRoller1 2:JONes:YYReal[?] on page 252
:OMG:SPRoperties:POLarization:CONTRoller1 2:PATtern:FILE[?]	:OMG:SPRoperties:POLarization:CONTRoller1 2:PATtern:FILE[?] on page 252
:OMG:SPRoperties:POLarization:CONTRoller1 2:PATtern:LENGth[?]	:OMG:SPRoperties:POLarization:CONTRoller1 2:PATtern:LENGth[?] on page 253
:OMG:SPRoperties:POLarization:CONTRoller1 2:PATtern:MODE[?]	:OMG:SPRoperties:POLarization:CONTRoller1 2:PATtern:MODE[?] on page 253
:OMG:SPRoperties:POLarization:CONTRoller1 2:PATtern:RATio[?]	:OMG:SPRoperties:POLarization:CONTRoller1 2:PATtern:RATio[?] on page 254
:OMG:SPRoperties:POLarization:CONTRoller1 2:PATtern:SHIFt[?]	:OMG:SPRoperties:POLarization:CONTRoller1 2:PATtern:SHIFt[?] on page 254
:OMG:SPRoperties:POLarization:CONTRoller1 2:PATtern:SPeed[?]	:OMG:SPRoperties:POLarization:CONTRoller1 2:PATtern:SPeed[?] on page 255
:OMG:SPRoperties:POLarization:CONTRoller1 2:STATic:RETardation[?]	:OMG:SPRoperties:POLarization:CONTRoller1 2:STATic:RETardation[?] on page 255
:OMG:SPRoperties:POLarization:CONTRoller1 2:STATic:ROTation[?]	:OMG:SPRoperties:POLarization:CONTRoller1 2:STATic:ROTation[?] on page 256
:OMG:SPRoperties:POLarization:PATtern:COMPLETE:ACTIVE[?]	:OMG:SPRoperties:POLarization:PATtern:COMPLETE:ACTIVE[?] on page 256
:OMG:SPRoperties:POLarization:PATtern:STEP:CURRENT[?]	:OMG:SPRoperties:POLarization:PATtern:STEP:CURRENT[?] on page 257

Name	Description under
:OMG:SPRoperties:POLarization:PATtern:STEP:NEXT	:OMG:SPRoperties:POLarization:PATtern:STEP:NEXT on page 257
:OMG:SPRoperties:POLarization:PATtern:STEP:PREVIOUS	:OMG:SPRoperties:POLarization:PATtern:STEP:PREVIOUS on page 258
:OMG:SPRoperties:POLarization:PATtern:STEP:PREVIOUS	:OMG:SPRoperties:POLarization:PATtern:STEP:PREVIOUS on page 258

* When setting or querying the state of one of the available PMD segments in seven-segment mode, the index of the segment's equivalent position in 14-segment mode must be used in for SCPI command. Thus, the available index positions for the segments 1 to 7 in seven-segment mode are: 1, 3, 5, 7, 9, 11, 13. This applies to all the index properties (enable, axis angle, phase).

SCPI index mapping in seven-segment mode:

Segment 1 – Index 1

Segment 2 – Index 3

Segment 3 – Index 5

Segment 4 – Index 7

Segment 5 – Index 9

Segment 6 – Index 11

Segment 7 – Index 13

:OMG:SPRoperties:NLTRansfer:BYPass[?]

Required Option #OSP

Command :OMG:SPR:NLTR:BYPass[?]

Long :OMG:SPRoperties:NLTRansfer:BYPass[?]

Parameters 0|1

Description Set or query whether nonlinear transfer functions are being applied. If BYPass is set to 1, nonlinear transfer functions are disabled.

Example Command:

:OMG:SPR:NLTR:BYPass 1

Query:

:OMG:SPR:NLTR:BYPass?

:OMG:SPRoperties:NLTRansfer:SAME[?]

Required Option	#OSP
Command	:OMG:SPR:NLTR:SAME[?]
Long	:OMG:SPRoperties:NLTRansfer:SAME[?]
Parameters	0 1
Description	Set or query whether to use the same (first) nonlinear transfer function file for all other channels as well.
Example	Command: :OMG:SPR:NLTR:SAME 1 Query: :OMG:SPR:NLTR:SAME?

:OMG:SPRoperties:NLTRansfer:XI|XQ|YI|YQ:FILE[?]

Required Option	#OSP
Command	:OMG:SPR:NLTR:XI XQ YI YQ:FILE[?]
Long	:OMG:SPRoperties:NLTRansfer:XI XQ YI YQ:FILE[?]
Parameters	String value
Description	Set or query the filename to be used for the respective channel if transfer function is set to user-defined. File needs to be located either on the PC that the 81195A OMG software is running on or on a network location, accessible by that PC.
Example	Command: :OMG:SPR:NLTR:XI:FILE '<filename>' Query: :OMG:SPR:NLTR:XI:FILE?

:OMG:SPRoperties:NLTRansfer:XI|XQ|YI|YQ:FUNCTION[?]

Required Option	#OSP
Command	:OMG:SPR:NLTR:XI XQ YI YQ:FUNC[?]
Long	:OMG:SPRoperties:NLTRansfer:XI XQ YI YQ:FUNCTION[?]

Parameters TRANSPARENT|ARCSINE|SINE|USER (enclosed in single or double quotes)

Description Set or query the transfer function used for the respective channel.

Example Command:
:OMG:SPR:NLTR:XI:FUNC 'TRAN'

Query:
:OMG:SPR:NLTR:XI:FUNC?

:OMG:SPROPERTIES:NLTRANSFER:XI|XQ|YI|YQ:RANGE[?]

Required Option #OSP

Command :OMG:SPR:NLTR:XI|XQ|YI|YQ:RANG[?]
Long :OMG:SPROPERTIES:NLTRANSFER:XI|XQ|YI|YQ:RANGE[?]

Parameters Numeric value

Description Set or query the input range of the transfer function to be used. Values less than one reflect cases where an input signal of maximum amplitude does not cover the whole input range of the transfer function

Example Command:
:OMG:SPR:NLTR:XI:RANG 1

Query:
:OMG:SPR:NLTR:XI:RANG?

:OMG:SPROPERTIES:PHASENOISE:ROTATOR2:PATTERN:FILE[?]

Required Option #OSP

Command :OMG:SPR:PHAS:ROT2:PATT:FILE[?]
Long :OMG:SPROPERTIES:PHASENOISE:ROTATOR2:PATTERN:FILE[?]

Parameters String value

Description Set or query the phase noise pattern filename if pattern source is set to user-defined. File needs to be located either on the PC that the 81195A OMG software is running on or on a network location, accessible by that PC.

Further details See section [Phase Noise / IQ Rotation](#) on page 112.

Example Command:
 :OMG:SPR:PHAS:ROT2:PATT:FILE '<filename>'
 Query:
 :OMG:SPR:PHAS:ROT2:PATT:FILE?

:OMG:SPRoperties:PHASenoiSe:ROTator2:BYPass[?]

Required Option #OSP
 Command :OMG:SPR:PHAS:ROT2:BYPass[?]
 Long :OMG:SPRoperties:PHASenoiSe:ROTator2:BYPass[?]
 Parameters 0|1
 Description Set or query whether phase noise is being applied. If BYPass is set to 1, phase noise generation is disabled. In order to actually enable phase noise generation, either the pattern and / or the frequency shift (constant rotation) needs to be set to active as well.
 Further details See section [Phase Noise / IQ Rotation](#) on page 112.
 Example Command:
 :OMG:SPR:PHAS:ROT2:BYPass 1
 Query:
 :OMG:SPR:PHAS:ROT2:BYPass?

:OMG:SPRoperties:PHASenoiSe:ROTator2:CONstant:RRATE[?]

Required Option #OSP
 Command :OMG:SPR:PHAS:ROT2:CON:RRATE[?]
 Long :OMG:SPRoperties:PHASenoiSe:ROTator2:CONstant:RRATE[?]
 Parameters Numeric value
 Description Set or query the constant phase rotation rate applied to the signal.
 Further details See section [Phase Noise / IQ Rotation](#) on page 112.
 Example Command:
 :OMG:SPR:PHAS:ROT2:CON:RRATE 0
 Query:

:OMG:SPR:PHAS:ROT2:CON:RRAT?

:OMG:SPRoperties:PHASenoiSe:ROTator2:CONStant:ACTive[?]

Required Option	#OSP
Command	:OMG:SPR:PHAS:ROT2:CONS:ACT[?]
Long	:OMG:SPRoperties:PHASenoiSe:ROTator2:CONStant:ACTive[?]
Parameters	0 1
Description	Set or query whether the frequency shift / constant rotation rate is applied to the signal. Requires Bypass to be set to 0 to have any effect.
Further details	See section Phase Noise / IQ Rotation on page 112.
Example	Command: :OMG:SPR:PHAS:ROT2:CONS:ACT 0 Query: :OMG:SPR:PHAS:ROT2:CONS:ACT?

:OMG:SPRoperties:PHASenoiSe:ROTator2:CONStant:FSHift[?]

Required Option	#OSP
Command	:OMG:SPR:PHAS:ROT2:CONS:FSH[?]
Long	:OMG:SPRoperties:PHASenoiSe:ROTator2:CONStant:FSHift[?]
Parameters	Numeric value
Description	Set or query the frequency shift applied to the signal.
Further details	See section Phase Noise / IQ Rotation on page 112.
Example	Command: :OMG:SPR:PHAS:ROT2:CONS:FSH 0 Query: :OMG:SPR:PHAS:ROT2:CONS:FSH?

:OMG:SPRoperties:PHASenoiSe:ROTator2:PATTern:ACTive[?]

Required Option	#OSP
-----------------	------

Command	:OMG:SPR:PHAS:ROT2:PATT:ACT[?]
Long	:OMG:SPRoperties:PHASenoiSe:ROTator2:PATtern:ACTive[?]
Parameters	0 1
Description	Set or query whether the phase noise pattern is applied to the signal. Requires Bypass to be set to 0 to have any effect.
Further details	See section Phase Noise / IQ Rotation on page 112.
Example	Command: :OMG:SPR:PHAS:ROT2:PATT:ACT 0 Query: :OMG:SPR:PHAS:ROT2:PATT:ACT?

:OMG:SPRoperties:PHASenoiSe:ROTator2:PATtern:SDIVider[?]

Required Option	#OSP
Command	:OMG:SPR:PHAS:ROT2:PATT:SDIV[?]
Long	:OMG:SPRoperties:PHASenoiSe:ROTator2:PATtern:SDIVider[?]
Parameters	Numeric value
Description	Set or query the phase noise pattern speed divider. Not available if pattern source is set to user-defined.
Further details	See section Phase Noise / IQ Rotation on page 112.
Example	Command: :OMG:SPR:PHAS:ROT2:PATT:SDIV 1 Query: :OMG:SPR:PHAS:ROT2:PATT:SDIV?

:OMG:SPRoperties:PHASenoiSe:ROTator2:PATtern:SOURce[?]

Required Option	#OSP
Command	:OMG:SPR:PHAS:ROT2:PATT:SOUR[?]
Long	:OMG:SPRoperties:PHASenoiSe:ROTator2:PATtern:SOURce[?]
Parameters	MODE USER (enclosed in single or double quotes)

Description	Set or query phase noise pattern source.
Further details	See section Phase Noise / IQ Rotation on page 112.
Example	Command: :OMG:SPR:PHAS:ROT2:PATT:SOUR 'MODE' Query: :OMG:SPR:PHAS:ROT2:PATT:SOUR?

:OMG:SPRoperties:PHASenoiSe:ROTator2:PATTern:MODel:FFNoise[?]

Required Option	#OSP
Command	:OMG:SPR:PHAS:ROT2:PATT:MOD:FFN[?]
Long	:OMG:SPRoperties:PHASenoiSe:ROTator2:PATTern:MODel:FFNoise[?]
Parameters	Numeric value
Description	Set or query the flicker frequency noise value used if pattern source is set to phase noise model.
Further details	See section Phase Noise / IQ Rotation on page 112.
Example	Command: :OMG:SPR:PHAS:ROT2:PATT:MOD:FFN 0 Query: :OMG:SPR:PHAS:ROT2:PATT:MOD:FFN?

:OMG:SPRoperties:PHASenoiSe:ROTator2:PATTern:MODel:FRWNoise[?]

Required Option	#OSP
Command	:OMG:SPR:PHAS:ROT2:PATT:MOD:FRWN[?]
Long	:OMG:SPRoperties:PHASenoiSe:ROTator2:PATTern:MODel:FRWNoise[?]
Parameters	Numeric value
Description	Set or query the flicker random walk noise value used if pattern source is set to phase noise model.
Further details	See section Phase Noise / IQ Rotation on page 112.
Example	Command:

:OMG:SPR:PHAS:ROT2:PATT:MOD:FRWN 0

Query:

:OMG:SPR:PHAS:ROT2:PATT:MOD:FRWN?

:OMG:SPRoperties:PHASenoise:ROTator2:PATTern:MODEl:LINewidth[?]

Required Option	#OSP
Command	:OMG:SPR:PHAS:ROT2:PATT:MOD:LIN[?]
Long	:OMG:SPRoperties:PHASenoise:ROTator2:PATTern:MODEl:LINewidth[?]
Parameters	Numeric value
Description	Set or query the laser linewidth value used if pattern source is set to phase noise model.
Further details	See section Phase Noise / IQ Rotation on page 112.
Example	Command: :OMG:SPR:PHAS:ROT2:PATT:MOD:LIN 500E3 Query: :OMG:SPR:PHAS:ROT2:PATT:MOD:LIN?

:OMG:SPRoperties:PHASenoise:ROTator2:PATTern:MODEl:RANDomize

Required Option	#OSP
Command	:OMG:SPR:PHAS:ROT2:PATT:MOD:RAND
Long	:OMG:SPRoperties:PHASenoise:ROTator2:PATTern:MODEl:RANDomize
Parameters	None
Description	Randomize the phase noise model seed.
Further details	See section Phase Noise / IQ Rotation on page 112.
Example	Command: :OMG:SPR:PHAS:ROT2:PATT:MOD:RAND

:OMG:SPRoperties:PHASenoise:ROTator2:PATTern:MODEl:SEED[?]

Required Option	#OSP
-----------------	------

Command	:OMG:SPR:PHAS:ROT2:PATT:MOD:SEED[?]
Long	:OMG:SPRoperties:PHASenoise:ROTator2:PATtern:MODel:SEED[?]
Parameters	Numeric value
Description	Set or query the random seed used if pattern source is set to phase noise model.
Further details	See section Phase Noise / IQ Rotation on page 112.
Example	Command: :OMG:SPR:PHAS:ROT2:PATT:MOD:SEED 0 Query: :OMG:SPR:PHAS:ROT2:PATT:MOD:SEED?

:OMG:SPRoperties:PMD:BYPass[?]

Required Option	#OSP
Command	:OMG:SPR:PMD:BYP[?]
Long	:OMG:SPRoperties:PMD:BYPass[?]
Parameters	0 1
Description	Set or query whether PMD is being applied. If BYPass is set to 1, PMD is disabled.
Further details	See section Polarization Mode Dispersion (PMD) on page 103.
Example	Command: :OMG:SPR:PMD:BYP 1 Query: :OMG:SPR:PMD:BYP?

:OMG:SPRoperties:PMD:DEPolarizati?

Required Option	#OSP
Command	:OMG:SPR:PMD:DEP?
Long	:OMG:SPRoperties:PMD:DEPolarizati?
Parameters	None

Description	Query the resulting Depolarization component of the 2nd order PMD, based on current PMD settings.
Further details	See section Polarization Mode Dispersion (PMD) on page 103.
Example	Command: :OMG:SPR:PMD:DEP?

:OMG:SPRoperties:PMD:MODE[?]

Required Option	#OSP
Command	:OMG:SPR:PMD:MODE[?]
Long	:OMG:SPRoperties:PMD:MODE[?]
Parameters	SEVen FOURteen (enclosed in single or double quotes)
Description	Set or query whether to use FIR file mode for PMD generation.
Further details	See section Polarization Mode Dispersion (PMD) on page 103.
Example	Command: :OMG:SPR:PMD:MODE 'SEV' Query: :OMG:SPR:PMD:MODE?

:OMG:SPRoperties:PMD:PCD?

Required Option	#OSP
Command	:OMG:SPR:PMD:PCD?
Long	:OMG:SPRoperties:PMD:PCD?
Parameters	None
Description	Query the resulting Polarization Chromatic Dispersion component of the 2nd order PMD, based on current PMD settings.
Further details	See section Polarization Mode Dispersion (PMD) on page 103.
Example	Command: :OMG:SPR:PMD:PCD?

:OMG:SPRoperties:PMD:PMD?

Required Option	#OSP
Command	:OMG:SPR:PMD:PMD?
Long	:OMG:SPRoperties:PMD:PMD?
Parameters	None
Description	Query the resulting PMD value, based on current PMD settings.
Further details	See section Polarization Mode Dispersion (PMD) on page 103.
Example	Command: :OMG:SPR:PMD:PMD?

:OMG:SPRoperties:PMD:PREDefined

Required Option	#OSP
Command	:OMG:SPR:PMD:PREd
Long	:OMG:SPRoperties:PMD:PREDefined
Parameters	NONE ZEROdgd PUREfirst MINFirst MAXFirst RANdOm (enclosed in single or double quotes)
Description	Set all PMD settings to values based on certain presets. Selecting RANdOm preset generates random settings based on current random seed. To generate a different set of PMD settings use the Randomize operation.
Further details	See section Polarization Mode Dispersion (PMD) on page 103.
Example	Command: :OMG:SPR:PMD:PREd 'NONE'

:OMG:SPRoperties:PMD:RANdOmize

Required Option	#OSP
Command	:OMG:SPR:PMD:RANd
Long	:OMG:SPRoperties:PMD:RANdOmize
Parameters	None
Description	Randomize the PMD model seed.

Further details See section [Polarization Mode Dispersion \(PMD\)](#) on page 103.

Example Command:
:OMG:SPR:PMD:RAND

:OMG:SPRproperties:PMD:SEED[?]

Required Option #OSP
 Command :OMG:SPR:PMD:SEED[?]
 Long :OMG:SPRproperties:PMD:SEED[?]
 Parameters Numeric value
 Description Set or query the random seed used if PMD settings are randomized.
 Further details See section [Polarization Mode Dispersion \(PMD\)](#) on page 103.
 Example Command:
 :OMG:SPR:PMD:SEED 0
 Query:
 :OMG:SPR:PMD:SEED?

:OMG:SPRproperties:PMD:SOPM?

Required Option #OSP
 Command :OMG:SPR:PMD:SOPM?
 Long :OMG:SPRproperties:PMD:SOPM?
 Parameters None
 Description Query the resulting Second-Order PMD value, based on current PMD settings.
 Further details See section [Polarization Mode Dispersion \(PMD\)](#) on page 103.
 Example Command:
 :OMG:SPR:PMD:SOPM?

:OMG:SPRproperties:PMD:DSP:FIR:CGain[?]

Required Option #OSP

Command	:OMG:SPR:PMD:DSP:FIR:CGA[?]
Long	:OMG:SPRoperties:PMD:DSP:FIR:CGAin[?]
Parameters	Numeric value
Description	Set or query the common gain value for the PMD DSP stage. Only available in Real-time mode.
Further details	See section Polarization Mode Dispersion (PMD) on page 103.
Example	Command: :OMG:SPR:PMD:DSP:FIR:CGA 1 Query: :OMG:SPR:PMD:DSP:FIR:CGA?

:OMG:SPRoperties:PMD:FIR:FMODe:ACTive[?]

Required Option	#OSP
Command	:OMG:SPR:PMD:FIR:FMOD:ACT[?]
Long	:OMG:SPRoperties:PMD:FIR:FMODe:ACTive[?]
Parameters	0 1
Description	Set or query whether to use FIR file mode for PMD generation.
Further details	See section Polarization Mode Dispersion (PMD) on page 103.
Example	Command: :OMG:SPR:PMD:FIR:FMOD:ACT 0 Query: :OMG:SPR:PMD:FIR:FMOD:ACT?

:OMG:SPRoperties:PMD:FIR:FMODe:FILE[?]

Required Option	#OSP
Command	:OMG:SPR:PMD:FIR:FMOD:FILE[?]
Long	:OMG:SPRoperties:PMD:FIR:FMODe:FILE[?]
Parameters	String value

Description	Set or query the filename to be used if FIR file mode is enabled for PMD generation. File needs to be located either on the PC that the 81195A OMG software is running on or on a network location, accessible by that PC.
Further details	See section Polarization Mode Dispersion (PMD) on page 103.
Example	Command: :OMG:SPR:PMD:FIR:FMODE:FILE '<filename>' Query: :OMG:SPR:PMD:FIR:FMODE:FILE?

:OMG:SPRproperties:PMD:PHASes:LINK[?]

Required Option	#OSP
Command	:OMG:SPR:PMD:PHAS:LINK[?]
Long	:OMG:SPRproperties:PMD:PHASes:LINK[?]
Parameters	0 1
Description	Set or query whether the phase values of all of the PMD model's birefringent elements should be identical. If this is set to 1, then setting any element's phase value will automatically set all other elements' phases to the same value.
Further details	See section Polarization Mode Dispersion (PMD) on page 103.
Example	Command: :OMG:SPR:PMD:PHAS:LINK 0 Query: :OMG:SPR:PMD:PHAS:LINK?

:OMG:SPRproperties:PMD:SEGment1|2|...|13|14:AXIS[?]

Required Option	#OSP
Command	:OMG:SPR:PMD:SEG1 2 ... 13 14:AXIS[?]
Long	:OMG:SPRproperties:PMD:SEGment1 2 ... 13 14:AXIS[?]
Parameters	Numeric value

Description	Set or query the axis angle of the PMD model's respective birefringent element. In seven-segment mode, the index of the segment's equivalent position in 14-segment mode must be used in the SCPI command. Thus, the available index positions for the segments 1 to 7 in seven-segment mode are: 1, 3, 5, 7, 9, 11, 13. SCPI index mapping in seven-segment mode: Segment 1 – Index 1, Segment 2 – Index 3, Segment 3 – Index 5, and so on.
Further details	See section Polarization Mode Dispersion (PMD) on page 103.
Example	Command: :OMG:SPR:PMD:SEG1:AXIS 0 Query: :OMG:SPR:PMD:SEG1:AXIS?
:OMG:SPRProperties:PMD:SEGment1 2 ... 13 14:ENABLE[?]	
Required Option	#OSP
Command	:OMG:SPR:PMD:SEG1 2 ... 13 14:ENAB[?]
Long	:OMG:SPRProperties:PMD:SEGment1 2 ... 13 14:ENABLE[?]
Parameters	0 1
Description	Set or query whether the PMD model's respective birefringent element is to be used for PMD generation. This way the effective number of stages used in the model can be influenced. In seven-segment mode, the index of the segment's equivalent position in 14-segment mode must be used in the SCPI command. Thus, the available index positions for the segments 1 to 7 in seven-segment mode are: 1, 3, 5, 7, 9, 11, 13. SCPI index mapping in seven-segment mode: Segment 1 – Index 1, Segment 2 – Index 3, Segment 3 – Index 5, and so on.
Further details	See section Polarization Mode Dispersion (PMD) on page 103.
Example	Command: :OMG:SPR:PMD:SEG1:ENAB 1 Query: :OMG:SPR:PMD:SEG1:ENAB?

:OMG:SPRoperties:PMD:SEGment1|2|...|13|14:PHASe[?]

Required Option	#OSP
Command	:OMG:SPR:PMD:SEG1 2 ... 13 14:PHAS[?]
Long	:OMG:SPRoperties:PMD:SEGment1 2 ... 13 14:PHASe[?]
Parameters	Numeric value
Description	Set or query the phase delay of the PMD model's respective birefringent element. In seven-segment mode, the index of the segment's equivalent position in 14-segment mode must be used in the SCPI command. Thus, the available index positions for the segments 1 to 7 in seven-segment mode are: 1, 3, 5, 7, 9, 11, 13. SCPI index mapping in seven-segment mode: Segment 1 – Index 1, Segment 2 – Index 3, Segment 3 – Index 5, and so on.
Further details	See section Polarization Mode Dispersion (PMD) on page 103.
Example	Command: :OMG:SPR:PMD:SEG1:PHAS 0 Query: :OMG:SPR:PMD:SEG1:PHAS?

:OMG:SPRoperties:POLarization:MODE[?]

Required Option	#OSP
Command	:OMG:SPR:POL:MODE[?]
Long	:OMG:SPRoperties:POLarization:MODE[?]
Parameters	BASE ADVA (enclosed in single or double quotes)
Description	Set or query whether basic mode (waveplates and patterns) or advanced mode (Jones matrices) is to be used.
Further details	See section Polarization on page 120.
Example	Command: :OMG:SPR:POL:MODE 'BASE' Query: :OMG:SPR:POL:MODE?

:OMG:SPRoperties:POLarization:COMBined:BYPass[?]

Required Option	#OSP
Command	:OMG:SPR:POL:COMB:BYPass[?]
Long	:OMG:SPRoperties:POLarization:COMBined:BYPass[?]
Parameters	0 1
Description	Set or query whether polarization changes are being applied. If BYPass is set to 1, polarization controller is disabled. This setting is only used if PMD generation is disabled.
Further details	See section Polarization on page 120.
Example	Command: :OMG:SPR:POL:COMB:BYPass 1 Query: :OMG:SPR:POL:COMB:BYPass?

:OMG:SPRoperties:POLarization:COMBined:INFO:SPEed?

Required Option	#OSP
Command	:OMG:SPR:POL:COMB:INFO:SPEed?
Long	:OMG:SPRoperties:POLarization:COMBined:INFO:SPEed?
Parameters	None
Description	Query information about the polarization rotation speed. This setting is only used if PMD generation is disabled.
Further details	See section Polarization on page 120.
Example	Command: :OMG:SPR:POL:COMB:INFO:SPEed?

:OMG:SPRoperties:POLarization:COMBined:INFO:STEP?

Required Option	#OSP
Command	:OMG:SPR:POL:COMB:INFO:STEP?
Long	:OMG:SPRoperties:POLarization:COMBined:INFO:STEP?
Parameters	None

Description	Query information about the polarization rotation steps. This setting is only used if PMD generation is disabled.
Further details	See section Polarization on page 120.
Example	Command: :OMG:SPR:POL:COMB:INFO:STEP?

:OMG:SPRoperties:POLarization:COMBined:PATTern:FILE[?]

Required Option	#OSP
Command	:OMG:SPR:POL:COMB:PATT:FILE[?]
Long	:OMG:SPRoperties:POLarization:COMBined:PATTern:FILE[?]
Parameters	String value
Description	Set or query the polarization pattern filename if pattern mode is set to user-defined. This setting is only used if PMD generation is disabled. File needs to be located either on the PC that the 81195A OMG software is running on or on a network location, accessible by that PC.
Further details	See section Polarization on page 120.
Example	Command: :OMG:SPR:POL:COMB:PATT:FILE '<filename>' Query: :OMG:SPR:POL:COMB:PATT:FILE?

:OMG:SPRoperties:POLarization:COMBined:PATTern:LENGth[?]

Required Option	#OSP
Command	:OMG:SPR:POL:COMB:PATT:LENG[?]
Long	:OMG:SPRoperties:POLarization:COMBined:PATTern:LENGth[?]
Parameters	Numeric value
Description	Set or query the polarization pattern length to be used. This setting is only used if PMD generation is disabled.
Further details	See section Polarization on page 120.
Example	Command:

```
:OMG:SPR:POL:COMB:PATT:LENG 10000
```

```
Query:
```

```
:OMG:SPR:POL:COMB:PATT:LENG?
```

:OMG:SPRoperties:POLarization:COMBined:PATTern:MODE[?]

Required Option	#OSP
Command	:OMG:SPR:POL:COMB:PATT:MODE[?]
Long	:OMG:SPRoperties:POLarization:COMBined:PATTern:MODE[?]
Parameters	USER CIRCle COIN SLICer (enclosed in single or double quotes)
Description	Set or query the polarization pattern mode to be used. This setting is only used if PMD generation is disabled.
Further details	See section Polarization on page 120.
Example	Command: :OMG:SPR:POL:COMB:PATT:MODE 'CIRC' Query: :OMG:SPR:POL:COMB:PATT:MODE?

:OMG:SPRoperties:POLarization:COMBined:PATTern:RATio[?]

Required Option	#OSP
Command	:OMG:SPR:POL:COMB:PATT:RAT[?]
Long	:OMG:SPRoperties:POLarization:COMBined:PATTern:RATio[?]
Parameters	Numeric value
Description	Set or query the polarization pattern ratio to be used. This setting is only used if PMD generation is disabled.
Further details	See section Polarization on page 120.
Example	Command: :OMG:SPR:POL:COMB:PATT:RAT 0.5 Query: :OMG:SPR:POL:COMB:PATT:RAT?

:OMG:SPROPERTIES:POLARIZATION:COMBINED:PATTERN:SHIFT[?]

Required Option	#OSP
Command	:OMG:SPR:POL:COMB:PATT:SHIF[?]
Long	:OMG:SPROPERTIES:POLARIZATION:COMBINED:PATTERN:SHIFT[?]
Parameters	Numeric value
Description	Set or query the polarization pattern shift to be used. This setting is only used if PMD generation is disabled.
Further details	See section Polarization on page 120.
Example	Command: :OMG:SPR:POL:COMB:PATT:SHIF 0 Query: :OMG:SPR:POL:COMB:PATT:SHIF?

:OMG:SPROPERTIES:POLARIZATION:COMBINED:PATTERN:SPEED[?]

Required Option	#OSP
Command	:OMG:SPR:POL:COMB:PATT:SPE[?]
Long	:OMG:SPROPERTIES:POLARIZATION:COMBINED:PATTERN:SPEED[?]
Parameters	Numeric value
Description	Set or query the polarization pattern speed to be used. This setting is only used if PMD generation is disabled.
Further details	See section Polarization on page 120.
Example	Command: :OMG:SPR:POL:COMB:PATT:SPE 1 Query: :OMG:SPR:POL:COMB:PATT:SPE?

:OMG:SPROPERTIES:POLARIZATION:CONTROLLER1|2:BYPASS[?]

Required Option	#OSP
Command	:OMG:SPR:POL:CONT1 2:BYPP[?]

Long	:OMG:SPRoperties:POLarization:CONTroller1 2:BYPass[?]
Parameters	0 1
Description	Set or query whether polarization changes are being applied for the respective polarization controller stage. If BYPass is set to 1, polarization controller is disabled. This setting is only used if PMD generation is enabled.
Further details	See section Polarization on page 120.
Example	Command: :OMG:SPR:POL:CONT1:BYP 1 Query: :OMG:SPR:POL:CONT1:BYP?

:OMG:SPRoperties:POLarization:CONTroller1|2:INFO:SPEed?

Required Option	#OSP
Command	:OMG:SPR:POL:CONT1 2:INFO:SPE?
Long	:OMG:SPRoperties:POLarization:CONTroller1 2:INFO:SPEed?
Parameters	None
Description	Query information about the polarization rotation speed for the respective polarization controller stage. This setting is only used if PMD generation is enabled.
Further details	See section Polarization on page 120.
Example	Command: :OMG:SPR:POL:CONT1:INFO:SPE?

:OMG:SPRoperties:POLarization:CONTroller1|2:INFO:STEP?

Required Option	#OSP
Command	:OMG:SPR:POL:CONT1 2:INFO:STEP?
Long	:OMG:SPRoperties:POLarization:CONTroller1 2:INFO:STEP?
Parameters	None

Description	Query information about the polarization rotation steps for the respective polarization controller stage. This setting is only used if PMD generation is enabled.
Further details	See section Polarization on page 120.
Example	Command: :OMG:SPR:POL:CONT1:INFO:STEP?

:OMG:SPRoperties:POLarization:CONTroller1|2:JONes:XXIMag[?]

Required Option	#OSP
Command	:OMG:SPR:POL:CONT1 2:JON:XXIM[?]
Long	:OMG:SPRoperties:POLarization:CONTroller1 2:JONes:XXIMag[?]
Parameters	Numeric value
Description	Set or query the imaginary part of the Jones matrix XX component to be used for the respective polarization controller stage. This setting is only used if polarization mode is set to Advanced.
Further details	See section Polarization on page 120.
Example	Command: :OMG:SPR:POL:CONT1:JON:XXIM 0 Query: :OMG:SPR:POL:CONT1:JON:XXIM?

:OMG:SPRoperties:POLarization:CONTroller1|2:JONes:XXReal[?]

Required Option	#OSP
Command	:OMG:SPR:POL:CONT1 2:JON:XXR[?]
Long	:OMG:SPRoperties:POLarization:CONTroller1 2:JONes:XXReal[?]
Parameters	Numeric value
Description	Set or query the real part of the Jones matrix XX component to be used for the respective polarization controller stage. This setting is only used if polarization mode is set to Advanced.
Further details	See section Polarization on page 120.
Example	Command:

:OMG:SPR:POL:CONT1:JON:XXR 1

Query:

:OMG:SPR:POL:CONT1:JON:XXR?

:OMG:SPR:Properties:POLarization:CONTroller1|2:JONes:XYIMag[?]

Required Option	#OSP
Command	:OMG:SPR:POL:CONT1 2:JON:XYIM[?]
Long	:OMG:SPR:Properties:POLarization:CONTroller1 2:JONes:XYIMag[?]
Parameters	Numeric value
Description	Set or query the imaginary part of the Jones matrix XY component to be used for the respective polarization controller stage. This setting is only used if polarization mode is set to Advanced.
Further details	See section Polarization on page 120.
Example	Command: :OMG:SPR:POL:CONT1:JON:XYIM 0 Query: :OMG:SPR:POL:CONT1:JON:XYIM?

:OMG:SPR:Properties:POLarization:CONTroller1|2:JONes:XYReal[?]

Required Option	#OSP
Command	:OMG:SPR:POL:CONT1 2:JON:XYR[?]
Long	:OMG:SPR:Properties:POLarization:CONTroller1 2:JONes:XYReal[?]
Parameters	Numeric value
Description	Set or query the real part of the Jones matrix XY component to be used for the respective polarization controller stage. This setting is only used if polarization mode is set to Advanced.
Further details	See section Polarization on page 120.
Example	Command: :OMG:SPR:POL:CONT1:JON:XYR 0 Query:

:OMG:SPR:POL:CONT1:JON:YXR?

:OMG:SPR:Properties:POLarization:CONTroller1|2:JONes:YXIMag[?]

Required Option	#OSP
Command	:OMG:SPR:POL:CONT1 2:JON:YXIM[?]
Long	:OMG:SPR:Properties:POLarization:CONTroller1 2:JONes:YXIMag[?]
Parameters	Numeric value
Description	Set or query the imaginary part of the Jones matrix YX component to be used for the respective polarization controller stage. This setting is only used if polarization mode is set to Advanced.
Further details	See section Polarization on page 120.
Example	Command: :OMG:SPR:POL:CONT1:JON:YXIM 0 Query: :OMG:SPR:POL:CONT1:JON:YXIM?

:OMG:SPR:Properties:POLarization:CONTroller1|2:JONes:YXReal[?]

Required Option	#OSP
Command	:OMG:SPR:POL:CONT1 2:JON:YXR[?]
Long	:OMG:SPR:Properties:POLarization:CONTroller1 2:JONes:YXReal[?]
Parameters	Numeric value
Description	Set or query the real part of the Jones matrix YX component to be used for the respective polarization controller stage. This setting is only used if polarization mode is set to Advanced.
Further details	See section Polarization on page 120.
Example	Command: :OMG:SPR:POL:CONT1:JON:YXR 0 Query: :OMG:SPR:POL:CONT1:JON:YXR?

:OMG:SPRoperties:POLarization:CONTroller1|2:JONes:YYIMag[?]

Required Option	#OSP
Command	:OMG:SPR:POL:CONT1 2:JON:YYIM[?]
Long	:OMG:SPRoperties:POLarization:CONTroller1 2:JONes:YYIMag[?]
Parameters	Numeric value
Description	Set or query the imaginary part of the Jones matrix YY component to be used for the respective polarization controller stage. This setting is only used if polarization mode is set to Advanced.
Further details	See section Polarization on page 120.
Example	Command: :OMG:SPR:POL:CONT1:JON:YYIM 0 Query: :OMG:SPR:POL:CONT1:JON:YYIM?

:OMG:SPRoperties:POLarization:CONTroller1|2:JONes:YYReal[?]

Required Option	#OSP
Command	:OMG:SPR:POL:CONT1 2:JON:YYR[?]
Long	:OMG:SPRoperties:POLarization:CONTroller1 2:JONes:YYReal[?]
Parameters	Numeric value
Description	Set or query the real part of the Jones matrix YY component to be used for the respective polarization controller stage. This setting is only used if polarization mode is set to Advanced.
Further details	See section Polarization on page 120.
Example	Command: :OMG:SPR:POL:CONT1:JON:YYR 1 Query: :OMG:SPR:POL:CONT1:JON:YYR?

:OMG:SPRoperties:POLarization:CONTroller1|2:PATTern:FILE[?]

Required Option	#OSP
-----------------	------

Command	:OMG:SPR:POL:CONT1 2:PATT:FILE[?]
Long	:OMG:SPRProperties:POLarization:CONTroller1 2:PATTern:FILE[?]
Parameters	String value
Description	Set or query the polarization pattern filename for the respective polarization controller if pattern mode is set to user-defined. This setting is only used if PMD generation is enabled. File needs to be located either on the PC that the 81195A OMG software is running on or on a network location, accessible by that PC.
Further details	See section Polarization on page 120.
Example	Command: :OMG:SPR:POL:CONT1:PATT:FILE '<filename>' Query: :OMG:SPR:POL:CONT1:PATT:FILE?

:OMG:SPRProperties:POLarization:CONTroller1|2:PATTern:LENGth[?]

Required Option	#OSP
Command	:OMG:SPR:POL:CONT1 2:PATT:LENG[?]
Long	:OMG:SPRProperties:POLarization:CONTroller1 2:PATTern:LENGth[?]
Parameters	Numeric value
Description	Set or query the polarization pattern length to be used for the respective polarization controller stage. This setting is only used if PMD generation is enabled.
Further details	See section Polarization on page 120.
Example	Command: :OMG:SPR:POL:CONT1:PATT:LENG 10000 Query: :OMG:SPR:POL:CONT1:PATT:LENG?

:OMG:SPRProperties:POLarization:CONTroller1|2:PATTern:MODE[?]

Required Option	#OSP
Command	:OMG:SPR:POL:CONT1 2:PATT:MODE[?]

Long	:OMG:SPRoperties:POLarization:CONTroller1 2:PATTern:MODE[?]
Parameters	USER CIRClE (enclosed in single or double quotes)
Description	Set or query the polarization pattern mode to be used for the respective polarization controller stage. This setting is only used if PMD generation is enabled.
Further details	See section Polarization on page 120.
Example	Command: :OMG:SPR:POL:CONT1:PATT:MODE 'CIRC' Query: :OMG:SPR:POL:CONT1:PATT:MODE?

:OMG:SPRoperties:POLarization:CONTroller1|2:PATTern:RATio[?]

Required Option	#OSP
Command	:OMG:SPR:POL:CONT1 2:PATT:RAT[?]
Long	:OMG:SPRoperties:POLarization:CONTroller1 2:PATTern:RATio[?]
Parameters	Numeric value
Description	Set or query the polarization pattern ratio to be used for the respective polarization controller stage. This setting is only used if PMD generation is enabled.
Further details	See section Polarization on page 120.
Example	Command: :OMG:SPR:POL:CONT1:PATT:RAT 0.5 Query: :OMG:SPR:POL:CONT1:PATT:RAT?

:OMG:SPRoperties:POLarization:CONTroller1|2:PATTern:SHIFt[?]

Required Option	#OSP
Command	:OMG:SPR:POL:CONT1 2:PATT:SHIF[?]
Long	:OMG:SPRoperties:POLarization:CONTroller1 2:PATTern:SHIFt[?]
Parameters	Numeric value

Description	Set or query the polarization pattern shift to be used for the respective polarization controller stage. This setting is only used if PMD generation is enabled.
Further details	See section Polarization on page 120.
Example	Command: :OMG:SPR:POL:CONT1:PATT:SHIF 0 Query: :OMG:SPR:POL:CONT1:PATT:SHIF?

:OMG:SPRoperties:POLarization:CONTroller1|2:PATTern:SPEed[?]

Required Option	#OSP
Command	:OMG:SPR:POL:CONT1 2:PATT:SPE[?]
Long	:OMG:SPRoperties:POLarization:CONTroller1 2:PATTern:SPEed[?]
Parameters	Numeric value
Description	Set or query the polarization pattern speed to be used for the respective polarization controller stage. This setting is only used if PMD generation is enabled.
Further details	See section Polarization on page 120.
Example	Command: :OMG:SPR:POL:CONT1:PATT:SPE 1 Query: :OMG:SPR:POL:CONT1:PATT:SPE?

:OMG:SPRoperties:POLarization:CONTroller1|2:STATic:RETardation[?]

Required Option	#OSP
Command	:OMG:SPR:POL:CONT1 2:STAT:RET[?]
Long	:OMG:SPRoperties:POLarization:CONTroller1 2:STATic:RETardation[?]
Parameters	Numeric value
Description	Set or query the static retardation value for the respective polarization controller stage. This value will change if complete pattern is used or pattern is stepped-through manually.

Further details See section [Polarization](#) on page 120.

Example Command:
:OMG:SPR:POL:CONT1:STAT:RET 0
Query:
:OMG:SPR:POL:CONT1:STAT:RET?

:OMG:SPRoperties:POLarization:CONTroller1|2:STATic:ROTation[?]

Required Option #OSP
Command :OMG:SPR:POL:CONT1|2:STAT:ROT[?]
Long :OMG:SPRoperties:POLarization:CONTroller1|2:STATic:ROTation[?]
Parameters Numeric value
Description Set or query the static rotation value for the respective polarization controller stage. This value will change if complete pattern is used or pattern is stepped-through manually.

Further details See section [Polarization](#) on page 120.

Example Command:
:OMG:SPR:POL:CONT1:STAT:ROT 0
Query:
:OMG:SPR:POL:CONT1:STAT:ROT?

:OMG:SPRoperties:POLarization:PATTern:COMplete:ACTive[?]

Required Option #OSP
Command :OMG:SPR:POL:PATT:COMP:ACT[?]
Long :OMG:SPRoperties:POLarization:PATTern:COMplete:ACTive[?]
Parameters 0|1
Description Set or query whether the complete polarization pattern is to be used or only the currently selected pattern step. If this is set to 0, the polarization pattern can be navigated manually using the Next / Previous step operations and the Current step setting.

Further details See section [Polarization](#) on page 120.

Example Command:
 :OMG:SPR:POL:PATT:COMP:ACT 1
 Query:
 :OMG:SPR:POL:PATT:COMP:ACT?

:OMG:SPRoperties:POLarization:PATTern:STEP:CURRent[?]

Required Option #OSP
 Command :OMG:SPR:POL:PATT:STEP:CURR[?]
 Long :OMG:SPRoperties:POLarization:PATTern:STEP:CURRent[?]
 Parameters Numeric value
 Description Set or query the current pattern step when manually stepping through the polarization pattern. Unavailable if complete pattern is activated.
 Further details See section **Polarization** on page 120.
 Example Command:
 :OMG:SPR:POL:PATT:STEP:CURR 1
 Query:
 :OMG:SPR:POL:PATT:STEP:CURR?

:OMG:SPRoperties:POLarization:PATTern:STEP:NEXT

Required Option #OSP
 Command :OMG:SPR:POL:PATT:STEP:NEXT
 Long :OMG:SPRoperties:POLarization:PATTern:STEP:NEXT
 Parameters None
 Description Step through the polarization pattern in positive direction (step size is 1% of the total pattern length). Unavailable if complete pattern is activated.
 Further details See section **Polarization** on page 120.
 Example Command:
 :OMG:SPR:POL:PATT:STEP:NEXT

:OMG:SPRoperties:POLarization:PATTern:STEP:PREVious

Required Option	#OSP
Command	:OMG:SPR:POL:PATT:STEP:PREV
Long	:OMG:SPRoperties:POLarization:PATTern:STEP:PREVious
Parameters	None
Description	Step through the polarization pattern in negative direction (step size is 1% of the total pattern length). Unavailable if complete pattern is activated.
Further details	See section Polarization on page 120.
Example	Command: :OMG:SPR:POL:PATT:STEP:PREV

WAVeform Subsystem

This subnode has the following commands:

Table 22

Name	Description under
:OMG:WAVeform:CYCLes?	:OMG:WAVeform:CYCLes? on page 260
:OMG:WAVeform:FILE[?]	:OMG:WAVeform:FILE[?] on page 261
:OMG:WAVeform:FORMat[?]	:OMG:WAVeform:FORMat[?] on page 261
:OMG:WAVeform:FSRate?	:OMG:WAVeform:FSRate? on page 262
:OMG:WAVeform:NSAMples[?]	:OMG:WAVeform:NSAMples[?] on page 262
:OMG:WAVeform:NSYMBOLs[?]	:OMG:WAVeform:NSYMBOLs[?] on page 263
:OMG:WAVeform:SOURce[?]	:OMG:WAVeform:SOURce[?] on page 264
:OMG:WAVeform:SPSYMBOL?	:OMG:WAVeform:SPSYMBOL? on page 264
:OMG:WAVeform:DATA:CMODE[?]	:OMG:WAVeform:DATA:CMODE[?] on page 264
:OMG:WAVeform:DATA:DCBalanced[?]	:OMG:WAVeform:DATA:DCBalanced[?] on page 265
:OMG:WAVeform:DATA:FILE[?]	:OMG:WAVeform:DATA:FILE[?] on page 265
:OMG:WAVeform:DATA:LENGth?	:OMG:WAVeform:DATA:LENGth? on page 266
:OMG:WAVeform:DATA:PRBS[?]	:OMG:WAVeform:DATA:PRBS[?] on page 266
:OMG:WAVeform:DATA:SOURce[?]	:OMG:WAVeform:DATA:SOURce[?] on page 267
:OMG:WAVeform:DATA:XMODE[?]	:OMG:WAVeform:DATA:XMODE YMODE[?] on page 267
:OMG:WAVeform:DATA:XYSHift[?]	:OMG:WAVeform:DATA:XYSHift[?] on page 268
:OMG:WAVeform:DATA:X XQ Y YQ:DCBalanced[?]	:OMG:WAVeform:DATA:X XQ Y YQ:DCBalanced[?] on page 268
:OMG:WAVeform:DATA:X XQ Y YQ:FILE[?]	:OMG:WAVeform:DATA:X XQ Y YQ:FILE[?] on page 269
:OMG:WAVeform:DATA:X XQ Y YQ:INVerted[?]	:OMG:WAVeform:DATA:X XQ Y YQ:INVerted[?] on page 269
:OMG:WAVeform:DATA:X XQ Y YQ:LENGth?	:OMG:WAVeform:DATA:X XQ Y YQ:LENGth? on page 270
:OMG:WAVeform:DATA:X XQ Y YQ:PRBS[?]	:OMG:WAVeform:DATA:X XQ Y YQ:PRBS[?] on page 270
:OMG:WAVeform:DATA:X XQ Y YQ:SHIFt[?]	:OMG:WAVeform:DATA:X XQ Y YQ:SHIFt[?] on page 270

Name	Description under
:OMG:WAVeform:DATA:XI XQ YI YQ:SOURce[?]	:OMG:WAVeform:DATA:XI XQ YI YQ:SOURce[?] on page 271
:OMG:WAVeform:DATA:XY:SAME[?]	:OMG:WAVeform:DATA:XY:SAME[?] on page 271
:OMG:WAVeform:MODulation:FILE[?]	:OMG:WAVeform:MODulation:FILE[?] on page 272
:OMG:WAVeform:MODulation:FORMat[?]	:OMG:WAVeform:MODulation:FORMat[?] on page 272
:OMG:WAVeform:MODulation:POFFset[?]	:OMG:WAVeform:MODulation:POFFset[?] on page 273
:OMG:WAVeform:RATE:BASE[?]	:OMG:WAVeform:RATE:BASE[?] on page 273
:OMG:WAVeform:RECommended:NSET	:OMG:WAVeform:RECommended:NSET on page 274
:OMG:WAVeform:RECommended:NUMBer?	:OMG:WAVeform:RECommended:NUMBer? on page 275
:OMG:WAVeform:RECommended:RATE?	:OMG:WAVeform:RECommended:RATE? on page 275
:OMG:WAVeform:RECommended:RSET	:OMG:WAVeform:RECommended:RSET on page 275
:OMG:WAVeform:STD:XI XQ YI YQ:MODE[?]	:OMG:WAVeform:STD:XI XQ YI YQ:MODE[?] on page 276
:OMG:WAVeform:STD:XI XQ YI YQ:PARAmeter[?]	:OMG:WAVeform:STD:XI XQ YI YQ:PARAmeter[?] on page 276

:OMG:WAVeform:CYCLes?

Command	:OMG:WAV:CYCL?
Long	:OMG:WAVeform:CYCLes?
Parameters	None
Description	Query the number of clock cycles covered by the currently defined waveform.
Further details	See section Waveform Input on page 80.
Example	Command: :OMG:WAV:CYCL?

:OMG:WAVeform:FILE[?]

Command	:OMG:WAV:FILE[?]
Long	:OMG:WAVeform:FILE[?]
Parameters	String value
Description	Select the file to be used when waveform source is set to external waveform. File needs to be located either on the PC that the 81195A OMG software is running on or on a network location, accessible by that PC.
Further details	See section Waveform Input on page 80.
Example	Command: :OMG:WAV:FILE '<filename>' Query: :OMG:WAV:FILE?

:OMG:WAVeform:FORMat[?]

Command	:OMG:WAV:FORM[?]
Long	:OMG:WAVeform:FORMat[?]
Parameters	CSV MAT (enclosed in single or double quotes)
Description	Set or query the format of the file that is going to be loaded from or saved to.
Further details	See section Waveform Input on page 80.
Example	Command: :OMG:WAV:FORM 'CSV' Query: :OMG:WAV:FORM?

:OMG:WAVeform:FSRate?

Command	:OMG:WAV:FSR?
Long	:OMG:WAVeform:FSRate?
Parameters	None
Description	Query the sampling rate for which the waveform file was saved. File needs to be loaded first.
Further details	See section Waveform Input on page 80.
Example	Query: :OMG:WAV:FSR?

:OMG:WAVeform:LOAD

Command	:OMG:WAV:LOAD
Long	:OMG:WAVeform:LOAD
Parameters	String value
Description	Select a waveform filename to be loaded from.
Further details	See section Waveform Input on page 80.
Example	Command: :OMG:WAV:LOAD '<filename>':

:OMG:WAVeform:NSAMples[?]

Command	:OMG:WAV:NSAM[?]
Long	:OMG:WAVeform:NSAMples[?]
Parameters	Numeric value
Description	Set or query the number of samples. Usually appropriate settings are applied automatically unless disabled in options menu.
Further details	See section Waveform Input on page 80.
Example	Command: :OMG:WAV:NSAM 16256 Query:

:OMG:WAV:NSAM?

:OMG:WAVeform:NSYMBOLS[?]

Command	:OMG:WAV:NSYM[?]
Long	:OMG:WAVeform:NSYMBOLS[?]
Parameters	Numeric value
Description	Set or query the number of symbols. Usually appropriate settings are applied automatically unless disabled in options menu.
Further details	See section Waveform Input on page 80.
Example	Command: :OMG:WAV:NSYM 8128 Query: :OMG:WAV:NSYM?

:OMG:WAVeform:SAVE

Command	:OMG:WAV:SAVE
Long	:OMG:WAVeform:SAVE
Parameters	String value
Description	Immediately generate a waveform based on current settings and save it using the given filename.
Further details	See section Waveform Input on page 80.
Example	Command: :OMG:WAV:SAVE '<filename>'

:OMG:WAVeform:SOURce[?]

Command	:OMG:WAV:SOUR[?]
Long	:OMG:WAVeform:SOURce[?]
Parameters	COMPLex STANdard FILE (enclosed in single or double quotes)
Description	Set or query the waveform source.
Further details	See section Waveform Input on page 80.
Example	Command: :OMG:WAV:SOUR 'COMP' Query: :OMG:WAV:SOUR?

:OMG:WAVeform:SPSymbol?

Command	:OMG:WAV:SPS?
Long	:OMG:WAVeform:SPSymbol?
Parameters	None
Description	Query the resulting ratio of samples and symbols based on the current settings.
Further details	See section Waveform Input on page 80.
Example	Command: :OMG:WAV:SPS?

:OMG:WAVeform:DATA:CMODE[?]

Command	:OMG:WAV:DATA:CMOD[?]
Long	:OMG:WAVeform:DATA:CMODE[?]
Parameters	MSB LSB (enclosed in single or double quotes)
Description	Set or query whether data is encoded with most-significant-bit or least-significant-bit first.
Further details	See section Waveform Input on page 80.

Example Command:
 :OMG:WAV:DATA:CMOD 'MSB'
 Query:
 :OMG:WAV:DATA:CMOD?

:OMG:WAVeform:DATA:DCBalanced[?]

Command :OMG:WAV:DATA:DCB[?]
 Long :OMG:WAVeform:DATA:DCBalanced[?]
 Parameters 0|1
 Description Set or query whether a DC balanced bit pattern is used. This setting is ignored if data source is set to Advanced or Patternfile.
 Further details See section [Waveform Input](#) on page 80.

Example Command:
 :OMG:WAV:DATA:DCB 0
 Query:
 :OMG:WAV:DATA:DCB?

:OMG:WAVeform:DATA:FILE[?]

Command :OMG:WAV:DATA:FILE[?]
 Long :OMG:WAVeform:DATA:FILE[?]
 Parameters String value
 Description Set or query the bit pattern file used if data source is set to pattern file. This setting is ignored if data source is set to Advanced or Patternfile.
 File needs to be located either on the PC that the 81195A OMG software is running on or on a network location, accessible by that PC.
 Further details See section [Waveform Input](#) on page 80.

Example Command:
 :OMG:WAV:DATA:FILE '<filename>'
 Query:
 :OMG:WAV:DATA:FILE?

:OMG:WAVeform:DATA:INFO?

Command	:OMG:WAV:DATA:INFO?
Long	:OMG:WAVeform:DATA:INFO?
Parameters	None
Description	Query compact information about advanced PRBS settings.
Further details	See section Waveform Input on page 80.
Example	Command: :OMG:WAV:DATA:INFO?

:OMG:WAVeform:DATA:LENGth?

Command	:OMG:WAV:DATA:LENG?
Long	:OMG:WAVeform:DATA:LENGth?
Parameters	None
Description	Query the data pattern length.
Further details	See section Waveform Input on page 80.
Example	Command: :OMG:WAV:DATA:LENG?

:OMG:WAVeform:DATA:PRBS[?]

Command	:OMG:WAV:DATA:PRBS[?]
Long	:OMG:WAVeform:DATA:PRBS[?]
Parameters	PRBS7OMA PRBS7NS PRBS9ITU PRBS11ITU PRBS15ITU PRBS15OMA PRBS201 PRBS202 PRBS231 PRBS232 PRBS29 PRBS311 PRBS312 (enclosed in single or double quotes)
Description	Set or query the PRBS pattern used. This setting is ignored if data source is set to Advanced or Patternfile.
Further details	See section Waveform Input on page 80.
Example	Command: :OMG:WAV:DATA:PRBS 'PRBS11ITU'

Query:
:OMG:WAV:DATA:PRBS?

:OMG:WAVeform:DATA:SOURce[?]

Command :OMG:WAV:DATA:SOUR[?]
 Long :OMG:WAVeform:DATA:SOURce[?]
 Parameters PRBS|FILE|ADVanced (enclosed in single or double quotes)
 Description Set or query the data source.
 Further details See section [Waveform Input](#) on page 80.
 Example Command:
 :OMG:WAV:DATA:SOUR 'PRBS'
 Query:
 :OMG:WAV:DATA:SOUR?

:OMG:WAVeform:DATA:XMODE|YMODE[?]

Command :OMG:WAV:DATA:XMOD|YMOD[?]
 Long :OMG:WAVeform:DATA:XMODE|YMODE[?]
 Parameters COMMon|EACH (enclosed in single or double quotes)
 Description Set or query whether a common pattern is used to generate I and Q data or whether each tributary has an individual bit pattern.
 Further details See section [Data Pattern](#) on page 92.
 Example Command:
 :OMG:WAV:DATA:XMOD 'COMM'
 Query:
 :OMG:WAV:DATA:XMOD?

:OMG:WAVeform:DATA:XYSHift[?]

Command	:OMG:WAV:DATA:XYSH[?]
Long	:OMG:WAVeform:DATA:XYSHift[?]
Parameters	Numeric value
Description	Set or query the relative shift of the bit patterns between X and Y polarization.
Further details	See section Waveform Input on page 80.
Example	Command: :OMG:WAV:DATA:XYSH 50 Query: :OMG:WAV:DATA:XYSH?

:OMG:WAVeform:DATA:XI|XQ|YI|YQ:DCBalanced[?]

Command	:OMG:WAV:DATA:XI XQ YI YQ:DCB[?]
Long	:OMG:WAVeform:DATA:XI XQ YI YQ:DCBalanced[?]
Parameters	0 1
Description	Set or query whether a DC balanced bit pattern is used for the respective channel.
Further details	See section Data Pattern on page 92.
Example	Command: :OMG:WAV:DATA:XI:DCB 0 Query: :OMG:WAV:DATA:XI:DCB?

:OMG:WAVeform:DATA:XI|XQ|YI|YQ:FILE[?]

Command	:OMG:WAV:DATA:XI XQ YI YQ:FILE[?]
Long	:OMG:WAVeform:DATA:XI XQ YI YQ:FILE[?]
Parameters	String value
Description	Set or query the bit pattern file used for the respective channel. File needs to be located either on the PC that the 81195A OMG software is running on or on a network location, accessible by that PC.
Further details	See section Data Pattern on page 92.
Example	Command: :OMG:WAV:DATA:XI:FILE '<filename>' Query: :OMG:WAV:DATA:XI:FILE?

:OMG:WAVeform:DATA:XI|XQ|YI|YQ:INVerted[?]

Command	:OMG:WAV:DATA:XI XQ YI YQ:INV[?]
Long	:OMG:WAVeform:DATA:XI XQ YI YQ:INVerted[?]
Parameters	0 1
Description	Set or query whether an inverted bit pattern is used for the respective channel.
Further details	See section Data Pattern on page 92.
Example	Command: :OMG:WAV:DATA:XI:INV 0 Query: :OMG:WAV:DATA:XI:INV?

:OMG:WAVeform:DATA:XI|XQ|YI|YQ:LENGth?

Command	:OMG:WAV:DATA:XI XQ YI YQ:LENG?
Long	:OMG:WAVeform:DATA:XI XQ YI YQ:LENGth?
Parameters	None
Description	Query the pattern length for the respective channel. Pattern will be repeated to match pattern length of other channels, if required.
Further details	See section Data Pattern on page 92.
Example	Command: :OMG:WAV:DATA:XI:LENG?

:OMG:WAVeform:DATA:XI|XQ|YI|YQ:PRBS[?]

Command	:OMG:WAV:DATA:XI XQ YI YQ:PRBS[?]
Long	:OMG:WAVeform:DATA:XI XQ YI YQ:PRBS[?]
Parameters	PRBS7OMA PRBS7NS PRBS9ITU PRBS11ITU PRBS15ITU PRBS15OMA PRBS201 PRBS202 PRBS231 PRBS232 PRBS29 PRBS311 PRBS312 (enclosed in single or double quotes)
Description	Set or query the PRBS pattern used for the respective channel.
Further details	See section Data Pattern on page 92
Example	Command: :OMG:WAV:DATA:XI:PRBS 'PRBS7OMA' Query: :OMG:WAV:DATA:XI:PRBS?

:OMG:WAVeform:DATA:XI|XQ|YI|YQ:SHIFt[?]

Command	:OMG:WAV:DATA:XI XQ YI YQ:SHIF[?]
Long	:OMG:WAVeform:DATA:XI XQ YI YQ:SHIFt[?]
Parameters	Numeric value
Description	Set or query the relative shift of the bit pattern for the respective channel.
Further details	See section Data Pattern on page 92.

Example Command:
 :OMG:WAV:DATA:XI:SHIF 0
 Query:
 :OMG:WAV:DATA:XI:SHIF?

:OMG:WAVeform:DATA:XI|XQ|YI|YQ:SOURce[?]

Command :OMG:WAV:DATA:XI|XQ|YI|YQ:SOUR[?]
 Long :OMG:WAVeform:DATA:XI|XQ|YI|YQ:SOURce[?]
 Parameters PRBS|FILE (enclosed in single or double quotes)
 Description Set or query the data source for the respective channel.
 Further details See section [Data Pattern](#) on page 92.
 Example Command:
 :OMG:WAV:DATA:XI:SOUR 'PRBS'
 Query:
 :OMG:WAV:DATA:XI:SOUR?

:OMG:WAVeform:DATA:XY:SAME[?]

Command :OMG:WAV:DATA:XY:SAME[?]
 Long :OMG:WAVeform:DATA:XY:SAME[?]
 Parameters 0|1
 Description Set or query whether X polarization settings are automatically applied to Y polarization as well.
 Further details See section [Data Pattern](#) on page 92.
 Example Command:
 :OMG:WAV:DATA:XY:SAME 1
 Query:
 :OMG:WAV:DATA:XY:SAME?

:OMG:WAVeform:MODulation:FILE[?]

Required Option	#OSP
Command	:OMG:WAV:MOD:FILE[?]
Long	:OMG:WAVeform:MODulation:FILE[?]
Parameters	String value
Description	Set or query the filename used if modulation format is set to user-defined. File needs to be located either on the PC that the 81195A OMG software is running on or on a network location, accessible by that PC.
Further details	See section Waveform Input on page 80.
Example	Command: :OMG:WAV:MOD:FILE '<filename>' Query: :OMG:WAV:MOD:FILE?

:OMG:WAVeform:MODulation:FORMat[?]

Command	:OMG:WAV:MOD:FORM[?]
Long	:OMG:WAVeform:MODulation:FORMat[?]
Parameters	BPSK QPSK PSK8 QAM8 QAM16 QAM32 QAM64 QAM128 QAM256 USER (enclosed in single or double quotes)(USER requires option #OSP)
Description	Set or query the modulation format used.
Further details	See section Waveform Input on page 80.
Example	Command: :OMG:WAV:MOD:FORM 'QPSK' Query: :OMG:WAV:MOD:FORM?

:OMG:WAVeform:MODulation:POFFset[?]

Command	:OMG:WAV:MOD:POFF[?]
Long	:OMG:WAVeform:MODulation:POFFset[?]
Parameters	Numeric value
Description	Set or query the modulation format's phase offset.
Further details	See section Waveform Input on page 80.
Example	Command: :OMG:WAV:MOD:POFF -90 Query: :OMG:WAV:MOD:POFF?

:OMG:WAVeform:RATE:BASE[?]

Command	:OMG:WAV:RATE:BASE[?]
Long	:OMG:WAVeform:RATE:BASE[?]
Parameters	FULL HALF QUARter RESAmpling (enclosed in single or double quotes)
Description	Set or get the base symbol rate. This can either be the maximum symbol rate possible at a given sampling rate, half or a quarter of that rate, as well as an arbitrary rate, using resampling. Resampling is not available in real-time mode.
Further details	See section Waveform Input on page 80.
Example	Command: :OMG:WAV:RATE:BASE 'FULL' Query: :OMG:WAV:RATE:BASE?

:OMG:WAVeform:RATE:SYMBol[?]

Command	:OMG:WAV:RATE:SYMB[?]
Long	:OMG:WAVeform:RATE:SYMBol[?]
Parameters	Numeric value
Description	Set or query the symbol rate. When using full, half or quarter base rates, this is just for indication. When using resampling, this setting is used to define the desired symbol rate.
Further details	See section Waveform Input on page 80.
Example	Command: :OMG:WAV:RATE:SYMB 32E9 Query: :OMG:WAV:RATE:SYMB?

:OMG:WAVeform:RECommended:NSET

Command	:OMG:WAV:REC:NSET
Long	:OMG:WAVeform:RECommended:NSET
Parameters	None
Description	Apply the recommended number of samples. This happens automatically unless disabled in options menu.
Further details	See section Waveform Input on page 80.
Example	Command: :OMG:WAV:REC:NSET

:OMG:WAVeform:RECommended:NUMBer?

Command	:OMG:WAV:REC:NUMB?
Long	:OMG:WAVeform:RECommended:NUMBer?
Parameters	None
Description	Query the recommended number of samples based on the current settings. Usually this recommended number is applied automatically unless disabled in options menu.
Further details	See section Waveform Input on page 80.
Example	Command: :OMG:WAV:REC:NUMB?

:OMG:WAVeform:RECommended:RATE?

Command	:OMG:WAV:REC:RATE?
Long	:OMG:WAVeform:RECommended:RATE?
Parameters	None
Description	Query the recommended sampling rate based on the current settings. Usually this recommended number is applied automatically unless disabled in options menu.
Further details	See section Waveform Input on page 80.
Example	Query: :OMG:WAV:REC:RATE?

:OMG:WAVeform:RECommended:RSET

Command	:OMG:WAV:REC:RSET
Long	:OMG:WAVeform:RECommended:RSET
Parameters	None
Description	Apply the recommended sampling rate. This happens automatically unless disabled in options menu.
Further details	See section Waveform Input on page 80.

Example Command:
:OMG:WAV:REC:RSET

:OMG:WAVeform:STD:XI|XQ|YI|YQ:MODE[?]

Command :OMG:WAV:STD:XI|XQ|YI|YQ:MODE[?]
 Long :OMG:WAVeform:STD:XI|XQ|YI|YQ:MODE[?]
 Parameters SINGle|MULTitone|RECTangular (enclosed in single or double quotes)
 Description Set or query the type of standard waveform for the respective channel if waveform source is set to standard waveform.
 Further details See section [Waveform Input](#) on page 80.
 Example Command:
 :OMG:WAV:STD:XI:MODE 'SING'
 Query:
 :OMG:WAV:STD:XI:MODE?

:OMG:WAVeform:STD:XI|XQ|YI|YQ:PARAmeter[?]

Command :OMG:WAV:STD:XI|XQ|YI|YQ:PAR[?]
 Long :OMG:WAVeform:STD:XI|XQ|YI|YQ:PARAmeter[?]
 Parameters String value
 Description Set or query standard waveform parameters for the respective channel if waveform source is set to standard waveform. Parameters are frequency in GHz, amplitude (V or mV) and phase in degrees, separated by semicolons.
 Further details See section [Waveform Input](#) on page 80.
 Example Command:
 :OMG:WAV:STD:XI:PAR '1;1;0'
 Query:
 :OMG:WAV:STD:XI:PAR?

7 File Formats and Example Files

[Example Files](#) / 278

[General Properties of ASCII / CSV Files](#) / 278

[Waveform file](#) / 278

[User-defined modulation file](#) / 279

[Data pattern file](#) / 280

[Pulseshaper file](#) / 280

[PMD FIR filter coefficient file](#) / 281

[Phase Noise / IQ rotator pattern file](#) / 281

[Polarization Controller pattern file](#) / 282

[Nonlinear transfer characteristics file](#) / 283

[Correction FIR coefficient file](#) / 284

Many controls of the 81195A software allow user-defined modes, i.e., files defining modulation constellations, filter coefficients, optical signal property patterns, etc.

This section points to a folder containing example files and defines the supported file format(s) for the individual settings that support user-defined mode.

Example Files

The 81195A installer brings a number of example files for each setting that supports user-defined mode. In the 81195A program folder there's a folder called \Example Files\, which contains several sub-folders, named by the respective setting they apply to.

General Properties of ASCII / CSV Files

In general, all settings that allow user-defined files in ASCII / CSV format assume the data to be formatted in columns.

In case of patterns, each line is expected to contain a pattern step.

In case of filters, each line is expected to contain a coefficient.

In case of modulation formats, each line is expected to contain a constellation point.

If the specific file is supposed to contain pairs/groups of data or data for multiple channels (or stages, as in case of the polarization controller), each element (of channels/stages etc.) is read from the available columns. Supported separators are comma (,), semicolon (;) and tab.

Unless otherwise noted, CSV/ASCII files are allowed, but not required to contain column alphanumeric column headers.

The files are allowed to contain comments. To qualify for a comment, a line must start with a percent sign (%) or a semicolon (;).

Waveform file

Waveform files are supported in CSV and MAT format.

Waveform files in MAT use the recording (MAT) file format of the 89601B VSA software. Please refer to the 89601B VSA User's Guide for details on this file format.

In CSV format, each column represents one physical signal channel. A preceding entry defines the sampling rate valid for this waveform file.

Example

```

SampleRate = 64.000 GHz
Y1, Y2, Y3, Y4
0.570, -0.188, 0.570, 0.570
0.625, 0.094, 0.016, -0.078
0.570, 0.570, -0.570, -0.570
0.391, 0.742, -0.508, -0.469
0.188, 0.570, -0.188, -0.188
0.109, 0.336, -0.289, -0.219
0.188, 0.188, -0.570, -0.188
0.297, 0.156, -0.594, 0.250
.
.
.

```

User-defined modulation file

The user defined modulation file contains the definition for a modulation format / constellation. Each new line in the file represents a symbol which is represented by its constellation point in the complex plane.

Example:

```

1+i
-1+1i
-1-1i
1-1i

```

Data pattern file

A data pattern file contains a bit pattern that can be used as data source. The file must be in J-BERT format (*.ptrn) which is a Keysight public standard format. For further information about the J-BERT format please consult the user's guide for the Keysight J-BERT N4903 High Performance Serial BERT, available on the Keysight website (see <http://literature.cdn.keysight.com/litweb/pdf/N4903-91021.pdf>).

J-BERT files may be provided in binary or in text format.

Example:

```
Version=EPA 2.0
Format=Text
Description=Description
Count=1
Length=400
Data=
3d 0f 9c 18 f4 ac 7a 49 d8 b4 4e b8 e4 ad 2d 4c dc 31 a5 9a
7a ac 35 2a cd
86 a7 51 e9 91 36 72 6b 45 3a e2 d2 b1 71 59 b1 8b 97 a9 8e
1e 91 5d 66 3a
```

Pulseshaper file

The pulse shaper file contains either 32 or 64 (see [Table 3](#) on page 39 for details) real-valued floating point numbers which represent the FIR filter coefficients.

NOTE

The spacing between filter coefficients is always $1/(\text{Internal Sampling Frequency})$. Therefore, when changing the base symbol rate (full-/half-/quarter-rate), the coefficients need to be modified to reflect the new desired pulse width. The number of available coefficients may change as shown in table <insert reference as in the note above>, but that is only affecting the total duration of the filter, not the spacing of the coefficients.

The absolute value of the coefficients must be less or equal to 1.

Example:

```
Filter coefficient 1
Filter coefficient 2
...
...
Filter coefficient 31
Filter coefficient 32
```

PMD FIR filter coefficient file

The PMD FIR filter coefficient file contains 4 columns with each having 7 complex-valued floating point numbers representing the FIR filter coefficients for h_{xx} , h_{yx} , h_{xy} and h_{yy} (see PMD filter structure in [Polarization Mode Dispersion \(PMD\)](#) on page 103).

The absolute value of the real and imaginary part of the coefficients must be less or equal to 1.

Example:

```
hxx, hyx, hxy, hyy
1, 0, 0, 1
0, 0, 0, 0
0, 0, 0, 0
0, 0, 0, 0
0, 0, 0, 0
0, 0, 0, 0
0, 0, 0, 0
0, 0, 0, 0
```

Phase Noise / IQ rotator pattern file

The phase noise / IQ rotator pattern file contains (up to 1024) real-valued floating point numbers representing the IQ rotation angle in grad for each pattern step.

The rotation angle itself does not have any range limitations however due to quantization effect the smallest non-zero difference between two pattern steps must not be less than app. 0.5° .

Example:

```
Rotation angle step 1
Rotation angle step 2
...
...
Rotation angle step 1023
Rotation angle step 1024
```

Polarization Controller pattern file

Polarization controller pattern files support ASCII/CSV format. The files are supposed to contain four columns when used without PMD emulation stage active and two columns with PMD emulation stage active.

4-stage controller (without PMD stage active)

The four columns in the file are supposed to contain rotation / retardation angles in degrees. Each row represents one pattern step.

Example:

Rotator (PC1) #1	Retarder (PC1) #1	Rotator (PC2) #1	Retarder (PC2) #1
Rotator (PC1) #2	Retarder (PC1) #2	Rotator (PC2) #2	Retarder (PC2) #2
Rotator (PC1) #3	Retarder (PC1) #3	Rotator (PC2) #3	Retarder (PC2) #3
...
...

Allowed range (Rotator angles): $0^\circ \dots 180^\circ$

Allowed range (Retarder angles): $0^\circ \dots 360^\circ$

2-stage controller (with PMD stage active)

The two columns in the file are supposed to contain rotation / retardation angles in degrees. Each row represents one pattern step.

Example:

Rotator #1	Retarder #1
Rotator #2	Retarder #2
Rotator #3	Retarder #3
...	...
...	...

Allowed range (Rotator angles):0°...180°

Allowed range (Retarder angles):0°...360°

Nonlinear transfer characteristics file

The Nonlinear transfer characteristic file contains 2 columns with each having 17 real-valued floating point numbers representing an X/Y pair from the piece-wise defined transfer function.

The absolute value of each X and Y value must be less or equal to 1.

X;Y

-1;-1

-0.875;-0.875

-0.75;-0.75

-0.625;-0.625

-0.5;-0.5

-0.375;-0.375

-0.25;-0.25

-0.125;-0.125

0;0

0.125;0.125

```
0.25;0.25  
0.375;0.375  
0.5;0.5  
0.625;0.625  
0.75;0.75  
0.875;0.875  
1;1
```

Correction FIR coefficient file

The correction FIR coefficient file contains either 16 real-valued floating point numbers which represent the FIR filter coefficients.

Example:

```
Filter coefficient 1  
Filter coefficient 2  
...  
...  
Filter coefficient 15  
Filter coefficient 16
```

The absolute value of the coefficients must be less or equal to 1.

8 Literature

- 1 D. Derrickson und M. Mueller, Digital Communications, Test and Measurements, 2007.
- 2 CCITT, ITU-T O.150, 1992.
- 3 D. R. Smith, Digital Transmission Systems, Springer Science+Business Media, LLC.
- 4 E. Vanin und G. Jacobsen, Analytical estimation of laser phase noise induced BER floor in coherent receiver with digital signal processing, Optics Express, Bd. 18, Nr. 5, pp. 4246-4259, 2010.
- 5 S. Camatel und V. Ferrero, Narrow Linewidth CW Laser Phase Noise Characterization Methods for Coherent Transmission System Applications, Journal of Lightwave Technology, Bd. 26, 2008.
- 6 D. Derickson, Fiber Optic Test and Measurement, Prentice Hall, 1997.
- 7 Optical Multi-Format Transmitter, ID Photonics, 2013. [Online].
- 8 Keysight Technologies, M8195A Arbitrary Waveform Generator - User's Guide, 2016. [Online]. Available: <http://www.keysight.com/find/M8195A>
- 9 Keysight Technologies, M8196A Arbitrary Waveform Generator - User's Guide, 2016. [Online]. Available: <http://www.keysight.com/find/M8196A>
- 10 Keysight Technologies, M8197A Multi-Channel Synchronization Module for M8195A - User's Guide, 2016. [Online]. Available: <http://www.keysight.com/find/M8197A>
- 11 Keysight Technologies, N4903B J-BERT high performance serial BERT - User's Guide, [Online]. Available: <http://www.keysight.com/find/N4903>

