



**TPR1000 and TPR4000
Active Power Rail Probes
User Manual**



077-1542-00



**TPR1000 and TPR4000
Active Power Rail Probes**

User Manual

Copyright © Tektronix. All rights reserved. Licensed software products are owned by Tektronix or its subsidiaries or suppliers, and are protected by national copyright laws and international treaty provisions.

Tektronix products are covered by U.S. and foreign patents, issued and pending. Information in this publication supersedes that in all previously published material. Specifications and price change privileges reserved.

TEKTRONIX and TEK are registered trademarks of Tektronix, Inc.

TekVPI is a trademark of Tektronix, Inc.

Contacting Tektronix

Tektronix, Inc.
14150 SW Karl Braun Drive
P.O. Box 500
Beaverton, OR 97077
USA

For product information, sales, service, and technical support:

- In North America, call 1-800-833-9200.
- Worldwide, visit www.tek.com to find contacts in your area.

Warranty

Tektronix warrants that this product will be free from defects in materials and workmanship for a period of one (1) year from the date of shipment. If any such product proves defective during this warranty period, Tektronix, at its option, either will repair the defective product without charge for parts and labor, or will provide a replacement in exchange for the defective product. Parts, modules and replacement products used by Tektronix for warranty work may be new or reconditioned to like new performance. All replaced parts, modules and products become the property of Tektronix.

In order to obtain service under this warranty, Customer must notify Tektronix of the defect before the expiration of the warranty period and make suitable arrangements for the performance of service. Customer shall be responsible for packaging and shipping the defective product to the service center designated by Tektronix, with shipping charges prepaid. Tektronix shall pay for the return of the product to Customer if the shipment is to a location within the country in which the Tektronix service center is located. Customer shall be responsible for paying all shipping charges, duties, taxes, and any other charges for products returned to any other locations.

This warranty shall not apply to any defect, failure or damage caused by improper use or improper or inadequate maintenance and care. Tektronix shall not be obligated to furnish service under this warranty a) to repair damage resulting from attempts by personnel other than Tektronix representatives to install, repair or service the product; b) to repair damage resulting from improper use or connection to incompatible equipment; c) to repair any damage or malfunction caused by the use of non-Tektronix supplies; or d) to service a product that has been modified or integrated with other products when the effect of such modification or integration increases the time or difficulty of servicing the product.

THIS WARRANTY IS GIVEN BY TEKTRONIX WITH RESPECT TO THE PRODUCT IN LIEU OF ANY OTHER WARRANTIES, EXPRESS OR IMPLIED. TEKTRONIX AND ITS VENDORS DISCLAIM ANY IMPLIED WARRANTIES OF MERCHANTABILITY OR FITNESS FOR A PARTICULAR PURPOSE. TEKTRONIX' RESPONSIBILITY TO REPAIR OR REPLACE DEFECTIVE PRODUCTS IS THE SOLE AND EXCLUSIVE REMEDY PROVIDED TO THE CUSTOMER FOR BREACH OF THIS WARRANTY. TEKTRONIX AND ITS VENDORS WILL NOT BE LIABLE FOR ANY INDIRECT, SPECIAL, INCIDENTAL, OR CONSEQUENTIAL DAMAGES IRRESPECTIVE OF WHETHER TEKTRONIX OR THE VENDOR HAS ADVANCE NOTICE OF THE POSSIBILITY OF SUCH DAMAGES.

[W2 – 15AUG04]

Table of Contents

Important Safety information	iii
General safety summary	iii
Service safety summary	iii
Terms in this manual	iv
Symbols and terms on the product	iv
Compliance information	v
Environmental considerations	v
Preface	vi
Documentation	vi
Conventions used in this manual	vi
Returning the probe for servicing	vi
Why use a power-rail probe?	vii
Theory of operation	vii
Key features	viii
Installation	1
Operating considerations	1
Connecting to the host instrument	2
Probe controls and indicators	2
Functional check	4
Required equipment	4
Basic operation	6
Required oscilloscope software versions	6
Probe input	6
Probe offset	7
Connect MMCX accessories	7
Connect solder-in accessories	7
Using the solder-pin installation tool	8
Using the tripod	9
Using the optional browser	9
Accessories and options	11
Standard accessories	11
Optional accessories	12
Options	14
Probing principles	15
Ground lead length	15
Ground lead inductance	16
Specifications	17
Warranted characteristics	17
Typical characteristics	18
Nominal characteristics	21
Accessory characteristics	21

Performance verification.....	26
Equipment required	26
Equipment setup	27
Check the DC gain accuracy	29
Check the DC input dynamic range	31
Check the input offset range and scale accuracy.....	32
Check the analog bandwidth	33
Test record.....	34
Maintenance	35
Error condition.....	35
Replacement parts	35
Cleaning	35
Index	

Important Safety information

This manual contains information and warnings that must be followed by the user for safe operation and to keep the product in a safe condition.

To safely perform service on this product, additional information is provided at the end of this section in the *Service safety summary*.

General safety summary

Use the product only as specified. Review the following safety precautions to avoid injury and prevent damage to this product or any products connected to it. Carefully read all instructions. Retain these instructions for future reference.

Probes and test leads

Before connecting probes or test leads, connect the power cord from the power connector to a properly grounded power outlet.

Inspect the probe and accessories. Before each use, inspect probe and accessories for damage (cuts, tears, or defects in the probe body, accessories, or cable jacket). Do not use if damaged.

High temperature probe tips



WARNING. To prevent a burn injury, when using a solder micro-coax or flex tip in a high temperature application, be sure to allow the tip to cool down before handling the tip.

Service safety summary

The *Service safety summary* section contains additional information required to safely perform service on the product. Only qualified personnel should perform service procedures. Read this *Service safety summary* and the *General safety summary* before performing any service procedures.

Do not service alone. Do not perform internal service or adjustments of this product unless another person capable of rendering first aid and resuscitation is present.

Terms in this manual

These terms may appear in this manual:



WARNING. *Warning statements identify conditions or practices that could result in injury or loss of life.*



CAUTION. *Caution statements identify conditions or practices that could result in damage to this product or other property.*

Symbols and terms on the product



When this symbol is marked on the product, be sure to consult the manual to find out the nature of the potential hazards and any actions which have to be taken to avoid them. (This symbol may also be used to refer the user to ratings in the manual.)

The following symbol(s) may appear on the product:



CAUTION
Refer to Manual

Compliance information

This product is intended for use by professionals and trained personnel only; it is not designed for use in households or by children.

Questions about the following compliance information may be directed to the following address:

Tektronix, Inc.
PO Box 500, MS 19-045
Beaverton, OR 97077, USA
www.tek.com

Environmental considerations

This section provides information about the environmental impact of the product.

Restriction of hazardous substances

Complies with RoHS2 Directive 2011/65/EU.

Product end-of-life handling

Observe the following guidelines when recycling an instrument or component:

Equipment recycling. Production of this equipment required the extraction and use of natural resources. The equipment may contain substances that could be harmful to the environment or human health if improperly handled at the product's end of life. To avoid release of such substances into the environment and to reduce the use of natural resources, we encourage you to recycle this product in an appropriate system that will ensure that most of the materials are reused or recycled appropriately.



This symbol indicates that this product complies with the applicable European Union requirements according to Directives 2012/19/EU and 2006/66/EC on waste electrical and electronic equipment (WEEE) and batteries. For information about recycling options, check the Tektronix Web site (www.tek.com/productrecycling).

Preface

This manual describes the installation and operation of the TPR1000 and TPR4000 active power rail probes. Basic probe operations and concepts are presented in this manual. The 6 Series MSO oscilloscope and the TPR4000 probe is used in all illustrations in this manual, unless noted otherwise. You can access this document and other related information from the Tektronix website (www.tek.com).

Documentation

To read about

Use these documents

TPR1000 and TPR4000 Probes: First Time Operation, Functional Check, Operating Basics, Specifications, Performance Verification

Read this Instruction Manual.

Conventions used in this manual

The following icon is used throughout this manual to indicate a step sequence.



Returning the probe for servicing

If your probe requires servicing, you must return the probe to Tektronix. If the original packaging is unfit for use or not available, use the following packaging guidelines:

Preparation for shipment

1. Use a corrugated cardboard shipping carton having inside dimensions at least one inch greater than the probe dimensions. The box should have a carton test strength of at least 200 pounds.
2. Put the probe into an antistatic bag or wrap it to protect it from dampness.
3. Place the probe into the box and stabilize it with light packing material.
4. Seal the carton with shipping tape.
5. Refer to *Contacting Tektronix* at the beginning of this manual for the shipping address.

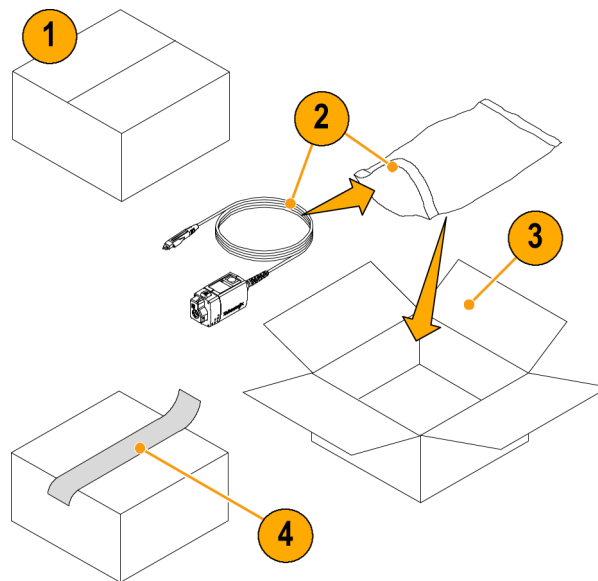

Why use a power-rail probe?

The added functionality, higher density, and faster switching speeds of modern electronic products drive the need for lower supply voltages. Designers need to zoom-in on power rails to look for high-frequency intruder signals, measure ripple and analyze coupling effects with tighter tolerances. Oscilloscopes often do not have enough offset to shift the noise and ripple on DC rails to the center of the screen to make the needed measurements.

The TPR1000 and TPR4000 probes provide a low-noise measurement solution (oscilloscope and probe), which is critical to not confuse the noise of the oscilloscope and probe with the noise and ripple of the DC supply being measured. The higher input impedance in the probes minimize the oscilloscope loading effect on DC rails (50 k Ω at DC). The probes provide higher bandwidth to see more signal content (harmonics, faster ripples, etc.) on DC rails that could affect data signals, clocks, etc.

The TPR1000 and TPR4000 provide a best-in-class solution for power integrity and validation engineers in the high speed (μ P), low power (mobile) and switched-mode power supply markets. The probes are designed to offer the lowest noise with high bandwidth at 60 V offset, flexible connectivity options to cover customers challenges, and software packages to cover the digital power management market.

Theory of operation

The block diagram shows the major circuit blocks or modules in the TPR1000 and TPR4000 probes.

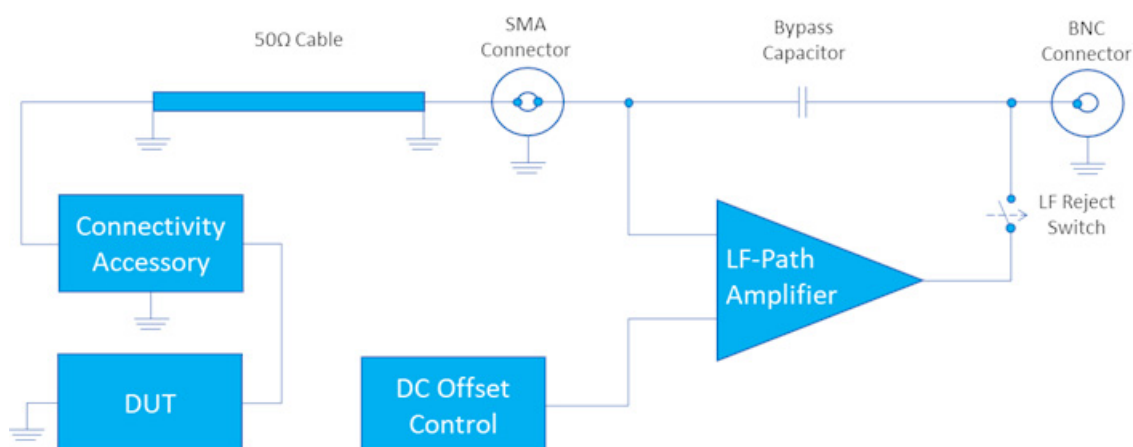

Figure i: TPR1000 and TPR4000 clock diagram

The TPR1000 and TPR4000 function by extending the oscilloscopes offset capability while maintaining a low noise signal path into the instrument. The linear dynamic range can be moved around the offset voltage operating window using the DC offset control into the LF amplifier. The LF amplifier can be disconnected when DC offset is not needed by setting the coupling mode to DC reject in the instrument vertical menu. The bypass capacitor acts as a low impedance path for high frequency components while blocking low frequency components. Because the TPR1000 and TPR4000 are designed for measuring the low source impedances of power distribution planes it is not recommended to measure devices with source impedances $>1 \Omega$ as it may cause distortion of the waveform.

Key features

The TPR1000 and TPR4000 probes provide a low noise, large offset range solution for measurement of ripple on DC power rails ranging from -60 to $+60$ VDC. Tektronix's power rail probes offer industry leading low noise and high offset range required to measure AC ripple between $200 \mu\text{Vp-p}$ and 1 Vp-p at up to 4 GHz . Key features include:



- Oscilloscope compatibility
6 series MSO, 5 series MSO, 4 series MSO, 3 series MDO, MDO3000¹, MDO4000C¹, MSO/DPO5000B, DPO7000C, and DPO70000C/DX/SX²
- Bandwidth (DC coupling mode)^{3 4}
TPR1000: DC to 1 GHz
TPR4000: DC to 4 GHz
- Bandwidth (DC reject mode)^{3 4}
TPR1000: 10 kHz to 1 GHz
TPR4000: 10 kHz to 4 GHz
- Linear dynamic range
Up to 60 V DC, 1 Vp-p to bandwidth⁵
- Attenuation: $1.25\times$ ³
- Measurement accuracy
DC linearity: $<0.1\%$
Step response long-term aberrations: $<\pm 1\%$
- Noise
 $<200 \mu\text{Vp-p}$ noise on 6 Series MSO (20 MHz BW Limit)
 $<1 \text{ mVp-p}$ noise on 6 Series MSO (Full Bandwidth)
- Input impedance
50 k Ω DC to 10 Hz
50 Ω AC $> 100 \text{ kHz}$
- Temperature range at tip⁶
 -40 to $+85 \text{ }^\circ\text{C}$ (standard accessories)
 -40 to $+155 \text{ }^\circ\text{C}$ (high temperature cable option)
- Offset
 $\pm 60 \text{ V}$ offset range
- Offset setting error
Max: $\pm(2\%$ of setting value + 2.5 mV)
Typical: $\pm(0.1\%$ + 2.5 mV) after SPC and Probe Zero

¹ Due to software incompatibilities between the TPR1000 and TPR4000 probes and the MDO3000 and MDO4000C oscilloscopes, the accuracy of probe measurements is reduced when these oscilloscopes are used in vertical scale settings less than 2 mV/division . For all other vertical scale settings, the specified accuracy of the probe is maintained.

² DPO70000 oscilloscopes require the optional TCA-VPI50 adapter.

³ Frequency response optimized for $<1 \Omega$ source impedance.

⁴ Through SMA-to-SMA cable or Solder Micro-Coax tip.

⁵ Max AC RMS of 1 V .

⁶ The comp box and oscilloscope temperature range is limited to the oscilloscope operating conditions. Please refer to the oscilloscope specifications.

Installation

Operating considerations

TPR1000 and TPR4000 power rail probe operating considerations.

Table 1: Environmental characteristics

Characteristic	Description
Temperature (comp box)	Operating: 0 to +50 °C (+32 to +122 °F) Nonoperating: -20 to +85 °C (-4 to +185 °F)
Temperature (standard accessories) ¹	Operating: -40 to +125 °C (-40 to +257 °F)
Temperature (optional high temperature accessories) ²	Operating: -55 to +155 °C (-67 to +311 °F)
Humidity (operating and nonoperating)	5-95% RH, tested up to +40 °C (+104 °F) 5-85% RH, tested above +40 °C (+104 °F)
Altitude	Operating: Up to 3000 meters (9,843 feet), Nonoperating: Up to 12,000 meters (39,370 feet)
Dynamics (random vibration)	Operating: 5 to 500 Hz, 2.66 gRMS Nonoperating: 5 to 500 Hz, 3.48 gRMS

¹ Operation temperature when using the standard accessory kit (TPR4KIT).

² Operation temperature when using the optional high temperature accessory kit (TPR4KITHT).

Connecting to the host instrument

1. Slide the probe body into the FlexChannel or VPI receptacle. The probe clicks into place when fully engaged.

When the probe is connected, the host instrument reads information from the probe and identifies the device.

NOTE. Allow the probe to warm up for at least 20 minutes to achieve guaranteed specifications.

2. Attach one of the following probe cables to the SMA connector on the probe body. Limit SMA nut torque to 8 in-lbs for either attachment or removal:

- SMA-to-SMA standard cable (standard accessory)
- SMA-to-MMCX standard cable (standard accessory)
- SMA-to-MMCX high-temperature cable (optional accessory)
- 1 GHz browser probe cable (optional accessory)

3. To disconnect, press the latch release button and pull away from the instrument.

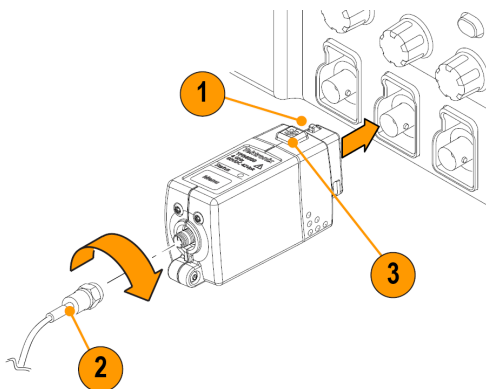

9637-001

Probe controls and indicators

Status LED

When the probe is powered on, the multicolor Status LED:

- A solid green LED indicates that the probe has initialized and is in the normal operating mode.
- A flashing green LED indicates that the probe is connected, but has not initialized.
- A red LED in any state indicates an error condition exists. (See page 35, *Error condition*.)

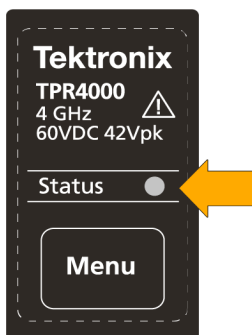

Menu button

1. Press the probe **Menu** button to display the Probe Control screen on the oscilloscope.
2. Use the touch-screen buttons on the instrument to set the probe parameters.
3. Press the probe **Menu** button again to close the Probe Control screen.



AutoZero

We recommend that you run the probe AutoZero routine:

- After the 20 minute warm-up period
- When the operating temperature of the probe changes by ± 5 °C

1. Press the probe **Menu** button to display the Probe Control screen on the oscilloscope.
2. Short the probe tip to ground.
3. Press the **AutoZero** button on the instrument to execute the AutoZero routine.



Functional check

Use the following procedure to check that your probe is functioning properly. To verify that your probe meets the warranted specifications, refer to the *Performance Verification* procedures. (See page 26.)

Required equipment

Description and quantity	Performance requirement	Recommended example
Oscilloscope	TekVPI Interface	Tektronix DPO7000 Series Tektronix 3 Series MDO Tektronix 4 Series MSO Tektronix 5 Series MSO Tektronix 6 Series MSO
SMA cable	1.3 m cable, SMA male-to-SMA male, 50 Ω	Cable included in standard accessory kit (TPR4KIT)
Sine wave generator	Frequency: 10 Mhz Amplitude: 1 Vpp, Offset 1 Vpp	

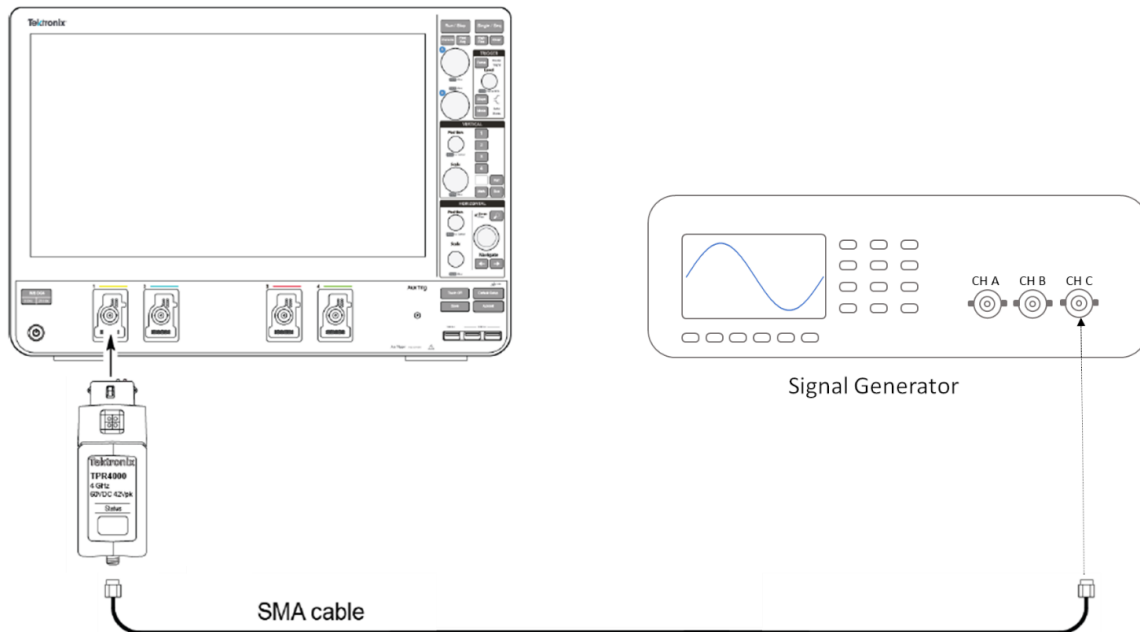

Figure 1: Functional check connection diagram

1. Connect the probe to the oscilloscope and a function generator as detailed in the connection diagram. (See Figure 1.)
2. If the function generator allows load impedance scaling, set the load impedance to high-Z. Otherwise, place a 50 Ω feed through terminator between the SMA cable and the probe.

3. Set the probes offset to 1 V and the vertical scale to 200 mV/div.
4. Set the function generator to 1 Vpp amplitude 1 V offset and the function to a 10 MHz sine wave.
5. The instrument should show a 1 Vpp sine wave on the screen centered around 1 V.
6. Open the vertical channel menu and change the coupling mode to DC reject.
7. Set the vertical offset to 0 V.
8. Confirm that the signal is centered around 0 V.

Basic operation

Follow these operating guidelines to get the best performance from your probe.

Required oscilloscope software versions

Oscilloscope	Required software version ¹
3 series MDO, 4 Series MSO, 5 Series MSO and 6 Series MSO	1.12.5
MDO3000	1.27462
MDO4000C	1.09354
MSO/DPO5000B	10.8.3.3
DPO7000C	10.8.3.3
DPO7000C/DX/SX	10.9.1

¹ The probe may operate with older versions of oscilloscope software. However, older software versions than those listed are not guaranteed to provide full probe functionality.

Probe input

The probe is electrically protected against static voltage. However, applying voltages above its design limits may damage the probe tip amplifier. (See Figure 2 on page 6.)

Input Linear Dynamic Range

The probe head amplifier used by the probe has a limited linear operating range. To keep the input linearity error within specification, you must limit the signal input voltage to ± 1 V.

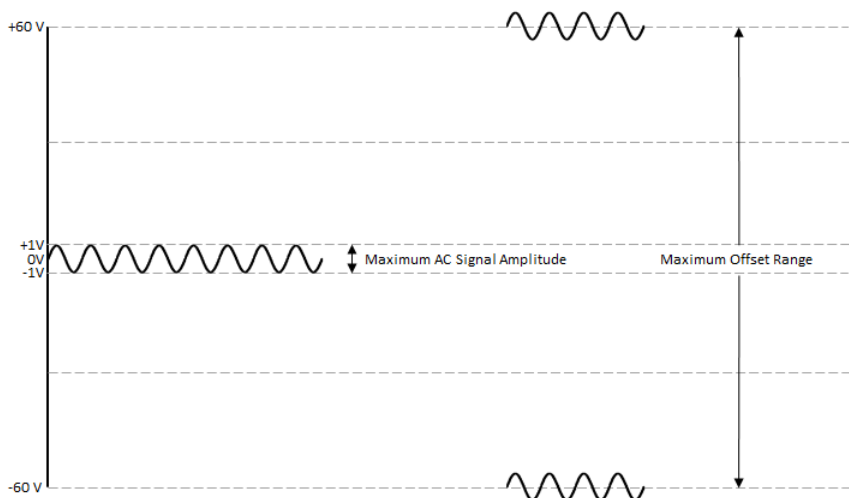

Figure 2: Dynamic and Offset Limitations

Probe offset

The probe offset is adjustable for operation within the linear range of the probe, and to increase the sensitivity of the probe at higher DC measurement voltages. Using the offset to cancel DC signal components enables optimal probe performance. (See Figure 2 on page 6.)

NOTE. See your oscilloscope manual for specific instructions on using the offset control.

To set the probe offset, follow these steps:

1. Set the probe offset equal to the expected nominal DC value of the source you are connecting to.
2. Set the vertical scale to 500 mV/div.
3. Connect the probe to the circuit.
4. Change the volts/div setting to the desired range, adjusting the offset as needed to keep the signal in the center of the screen.

The probe has a ± 60 V offset range. The linear operating range is ± 1 V. (See Figure 2 on page 6.) When you adjust the probe offset with no signal applied to the probe input, the output range is ± 1 V, (the linear operating range of the probe), not the ± 60 V offset range of the probe. However, when you apply up to ± 60 V to the probe input, the probe offset control can zero this offset.

NOTE. If the signal on the screen displays an offset that is either 1 Volt higher or lower than expected, check to make sure the DUT is connected and operating. This is a result of the input to the LF amplifier being clamped at one extreme of the dynamic range when no input is present.

Connect MMCX accessories

Gently insert the MMCX end of the cable into one of the following accessories: micro-coax tip, solder flex tip, u.fl adapter or MMCX to square pin Y-lead adapter, until you feel the connector engage. To remove an accessory, gently pull from the MMCX connection point, being careful to only grip the knurled metal area of the connector.

Connect solder-in accessories

Micro-coax tip. For convenient first-time use, the solder micro-coax tips are shipped pre-trimmed and ready to be soldered to the test point. You can reuse a tip by removing the tip from the solder joint and then trimming the wire insulation back to expose the center pin and ground shield on the tip cable.

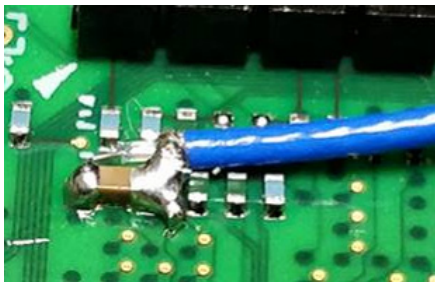

Flex tip. To attach the solder flex tip, first solder the enameled self-fluxing copper wire (standard accessory) to the test point. Feed the wire through the vias on the end of the flex tip, and then apply a small amount of solder to the vias to attach the wire to the tip.

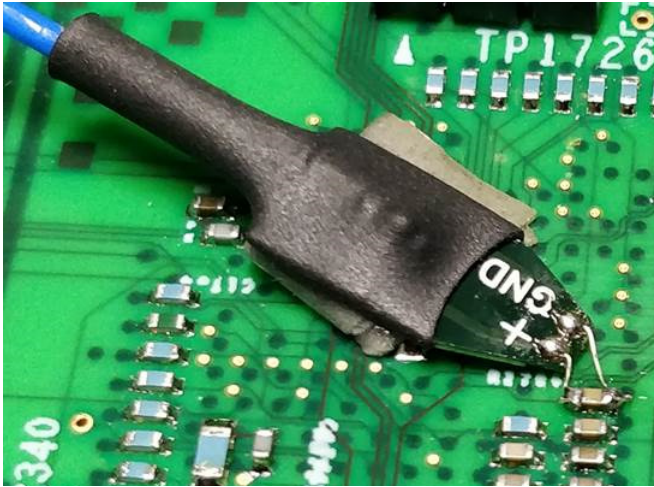

Using the solder-pin installation tool

The supplied set of solder pins are intended to be installed on DUT circuit boards and used with the supplied MMCX-to-square-pin adapter. To install the solder pins, use the supplied soldering-aid tool as described below

NOTE. The solder pins are extremely small and can be challenging to handle. It is recommended to use tweezers and a magnifying tool when installing pins on a circuit board.

1. Carefully insert the solder pins into the soldering aid tool as shown below.

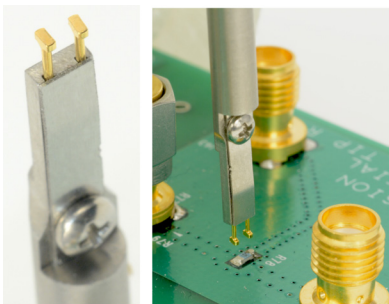

2. Use the soldering aid tool to hold the solder pins in place while soldering the pins to the circuit board.
3. If necessary, apply a small amount of adhesive to further strengthen the connection to the circuit board. However, keep the height of the adhesive to a minimum to provide good electrical contact for the adapter.

Using the tripod

The tripod probe support adds stability to square-pin mounted test points. For more stability, use glue to attach the tripod legs to the DUT circuit board.



Using the optional browser

The optional browser kit contains the following parts: up to 1 GHz browser probe, square pin Y-lead adapter, micro-SMD clip, three ground leads (alligator, blade, spring), and four replacement probe-tip pins (two rigid, two spring loaded).



WARNING. To prevent injury to the operator or damage to the probe, oscilloscope and device under test, do not touch the probe ground to any point that is not at the same potential as the chassis ground of the oscilloscope. The probe ground must be connected to the same potential as the chassis ground of the oscilloscope.

Installing ground leads. To obtain accurate measurements, always attach a ground lead to the probe tip before making measurements. It is recommended that you use the shortest ground lead that will function in your electrical application. The following illustration shows the browser probe tip, the tip cover and the three types of ground leads supplied with the browser.

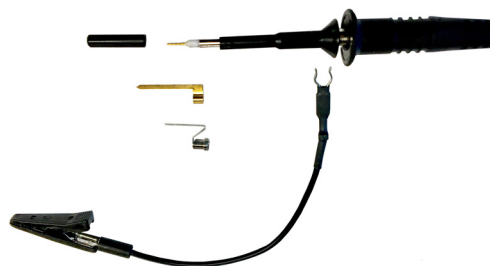

To install the ground leads:

- Spring: Slide the ground lead over the probe tip until it seats around the metal part of the probe-tip housing.
- Alligator: Slide the ground lead prongs over the exposed metal between the plastic probe-tip sections.
- Blade: Locate the slot in the probe-tip housing as shown below. Slide the ground lead over the probe tip until the blade slides into the slot.

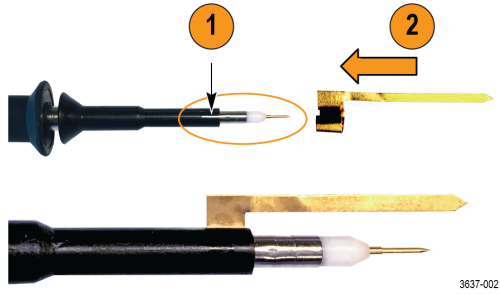

Connecting the Y-lead adapter and micro-SMD clip. The browser kit includes a Y-lead adapter and a micro-SMD clip that connect as shown below. The Y-lead adapter can also connect to square pins.

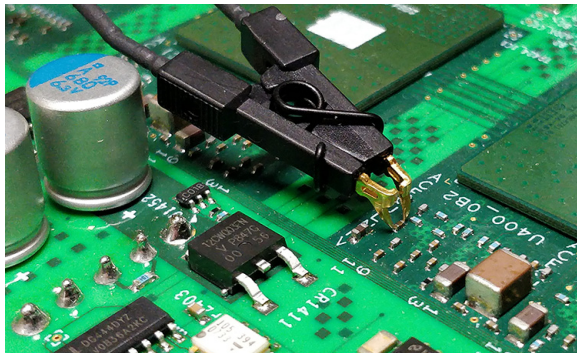
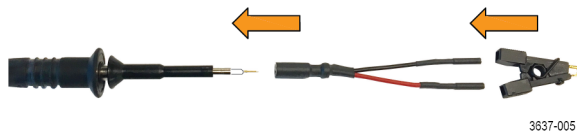

Replacing browser-tip pins. To remove the browser-tip pin, use pliers to grasp the pin and gently pull it out of the tip housing. To install a new browser-tip pin, select between a solid (silver colored) or spring-loaded (gold colored) pin, and then use pliers to gently insert the pin into the browser-tip housing until you feel the pin press against the bottom of the housing.



Accessories and options

This section lists the standard accessories and provides information on how to use the accessories. Specifications are provided where appropriate so that you can choose the accessory that best fits your needs. In some cases, reorder kit quantities differ from the actual number of accessories included with the probe.

Standard accessories

Each probe is shipped with one TPR4KIT accessory kit containing the following items:

Item	
1.3 m cable, SMA male-to-MMCX male, 50 Ω	
1.3 m cable, SMA male-to-SMA male, 50 Ω	
Y-lead adapter, MMCX female-to-0.8 mm sockets	
Adapter cable, MMCX female-to-U.FL female, 50 Ω	
Adapter, MMCX female-to-square pin (0.062 centers)	
DUT interface solder pins, set of 20	
Soldering aide tool, 0.062 solder pins over SMT	



Item

Solder-in cable adapter, MMCX female-to-solder micro-coax tip, 50 Ω , set of 3



Solder-in cable adapter, MMCX female-to-solder flex-paddle tip, 50 Ω , set of 3



Wire card, solderable enameled self-fluxing copper wire (for use with the solder-in tips)



Probe tip tripod support (with living hinge)



Marker bands, set of 5 (for probe identification)



Optional accessories

This section lists the optional accessories that you can purchase to help you with your probing tasks.

The optional TPR4KITHT high-temperature accessory kit includes the following items:

Item

2 m high-temperature cable, SMA male-to-MMCX male, 50 Ω



Solder-in cable adapter, MMCX female-to-solder micro-coax tip, 50 Ω , set of 3



Solder-in cable adapter, MMCX female-to-solder flex-paddle tip, 50 Ω , set of 3



The optional TPRBRWSR1G browser accessory kit includes the following items:

Item

Browser



Ground leads (blade, 0.5 mm spring, 15 cm alligator)



Y-lead adapter, browser tip-to-0.8 mm sockets



Micro-SMD clip



Replacement 0.5 mm browser tips (2 solid tips, 2 spring tips)



The optional TPR4SIACOAX accessory kit includes the following items:

Item

Solder-in cable adapter, MMCX female-to-solder micro-coax tip, 50 Ω, set of 3



The optional TPR4SIAFLEX accessory kit includes the following items:

Item

Solder-in cable adapter, MMCX female-to-solder flex-paddle tip, 50 Ω, set of 3



Options

Service Options

- **Option CA1.** Provides coverage for a single Calibration Event
- **Option C3.** Calibration Service 3 years
- **Option C5.** Calibration Service 5 years
- **Option D1.** Calibration Data Report
- **Option D3.** Calibration Data Report, 3 years (with Option C3)
- **Option D5.** Calibration Data Report, 5 years (with Option C5)
- **Option R3.** Repair Service 3 years
- **Option R5.** Repair Service 5 years

Manual Options

- **Option L0.** English language Instruction Manual
- **Option L5.** Japanese language Instruction Manual
- **Option L7.** Simplified Chinese language Instruction Manual

Probing principles

Follow these helpful hints to make probing easier and noise free.

Ground lead length

When you are probing a circuit, you should always use as short a ground lead as possible between the probe head and circuit ground. (See the illustration for the effects of lead length on waveform distortion.)

The series inductance added by the probe tip and ground lead can result in a resonant circuit; this circuit may cause parasitic ringing within the bandwidth of your oscilloscope.

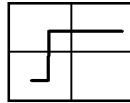

Low-inductance
Ground

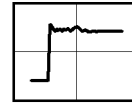
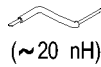

Three-inch
Ground

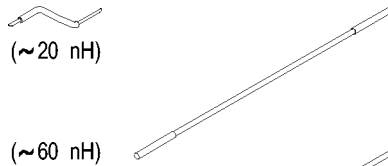

Six-inch
Ground

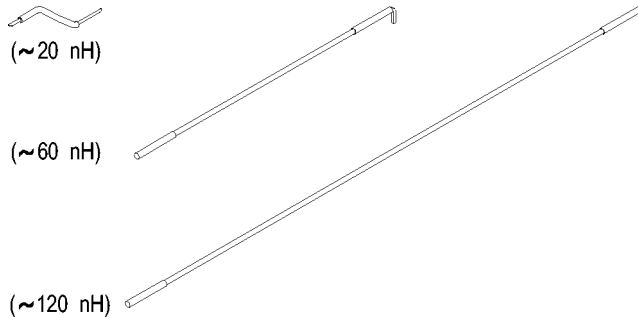

Ground lead inductance

When you touch your probe tip to a circuit element, you are introducing a new resistance, capacitance, and inductance into the circuit.

You can determine if ground lead effects may be a problem in your application if you know the self-inductance (L) and capacitance (C) of your probe and ground lead. Calculate the approximate resonant frequency (f_0) at which this parasitic circuit will resonate with the following formula: $f_0 = \frac{1}{2\pi\sqrt{L_{gl} C_{in}}}$

The equation shows that reducing the ground lead inductance will raise the resonant frequency. If your measurements are affected by ringing, your goal is to lower the inductance of your ground path until the resulting resonant frequency is well above the frequency of your measurements.

The low-inductance ground contacts described in *Accessories* can help you reduce the effects of ground lead inductance on your measurements.

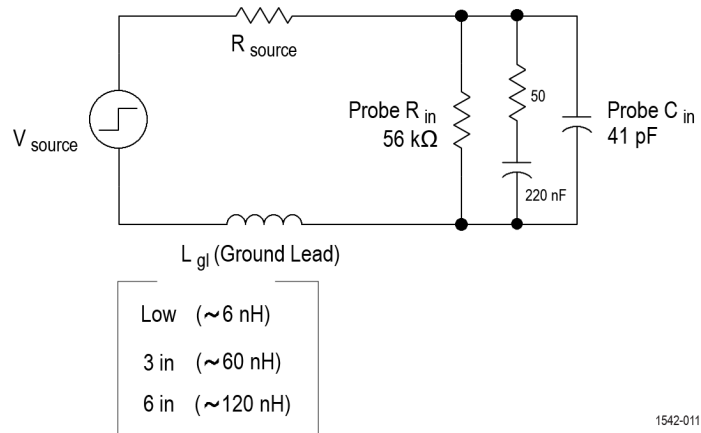

1542-011

Specifications

The specifications are valid under the following conditions:

- The probe has been calibrated at an ambient temperature of 23 °C ±5 °C.
- The probe is connected to a host instrument with an input impedance of 50 Ω.
- The probe and oscilloscope must have a warm-up period of at least 20 minutes and be in an environment that does not exceed the limits described. (See Table 1.)
- The Signal Path Compensation (SPC) has been run on the oscilloscope before testing the probe specifications.

Specifications for the TPR1000 and TPR4000 power rail probes fall into three categories: warranted, typical, and nominal characteristics. The warranted, typical, and mechanical characteristics apply to the TPR1000 and TPR4000 probes unless noted otherwise. Environmental characteristics are in the *Operating considerations* section. (See Table 1.)

Warranted characteristics

Warranted characteristics describe guaranteed performance within tolerance limits or certain type-tested requirements. Warranted characteristics that have checks in the *Performance Verification* section are marked with the ✓ symbol.

Table 2: Warranted electrical characteristics

Characteristic	Description
DC attenuation	1.25x
✓ DC attenuation accuracy	<±1% within 80% of DC dynamic range
✓ Analog bandwidth (SMA configuration)	1 GHz (TPR1000) 4 GHz (TPR4000)
DC input dynamic range	>±1 V
✓ Offset scale accuracy	±(2% of setting value + 2.5 mV max) Typical value is ±(0.1% + 2.5 mV) after SPC and Probe Zero

Typical characteristics

Typical characteristics describe typical but not guaranteed performance.

Table 3: Typical electrical characteristics

Characteristic	Description
DC input resistance	50 k Ω
Return loss	Maximum: -12 dB between 10 MHz and 1 GHz (TPR1000) ¹ Maximum: -12 dB between 10 MHz and 4 GHz (TPR4000) ¹
DC to AC impedance crossover frequency	300 Hz
DC to AC gain matching	$\pm 1\%$
Risetime (small signal, 20% to 80%)	282 pS (TPR1000) 88 pS (TPR4000)
Risetime (small signal, 10% to 90%)	408 pS (TPR1000) 128 pS (TPR4000)
Step Response Long Term Aberrations	<1% of final value after 50 μ S
Delay time (comp box only)	565 ps $\pm 20\%$ (TPR1000) 475 ps $\pm 20\%$ (TPR4000)
Delay time for each accessory	6.19 ns $\pm 10\%$ (1.3 m MMCX cable) 9.47 ns $\pm 10\%$ (2 m MMCX cable) 494 pS $\pm 20\%$ (10 cm blue coax solder-in) 500 pS $\pm 20\%$ (10 cm Flex Paddle Adapter) 484 pS $\pm 20\%$ (U.FL to MMCX Adapter) 5.2 nS $\pm 10\%$ (Browser)
Delay time (default configuration)	7.12 nS
NOTE. Base configuration consists of 1.3 m SMA to MMCX cable + MMCX micro coax tip (TRPSIACOAX)	
Noise	Typical: <25% RMS additive to oscilloscope at full bandwidth
Noise (probe only, DC to 20 MHz)	Maximum: 220 μ V p-p Typical: 165 μ V p-p into 6-series MSO
Input common mode rejection	-20 dB 20 Hz up to probe bandwidth

¹ 50 Ω reference impedance

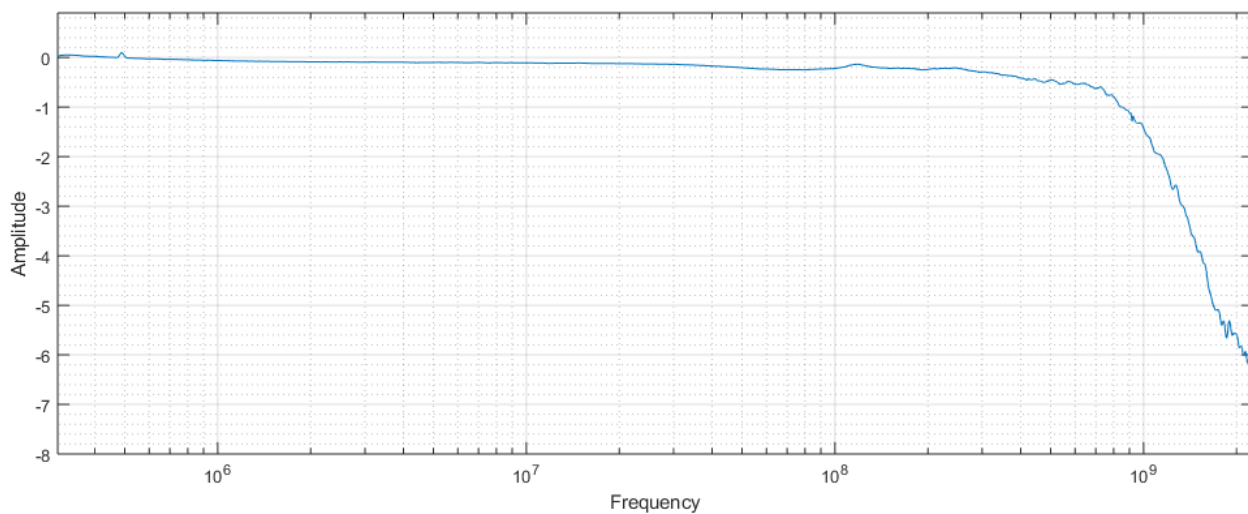

Figure 3: TPR1000 frequency response

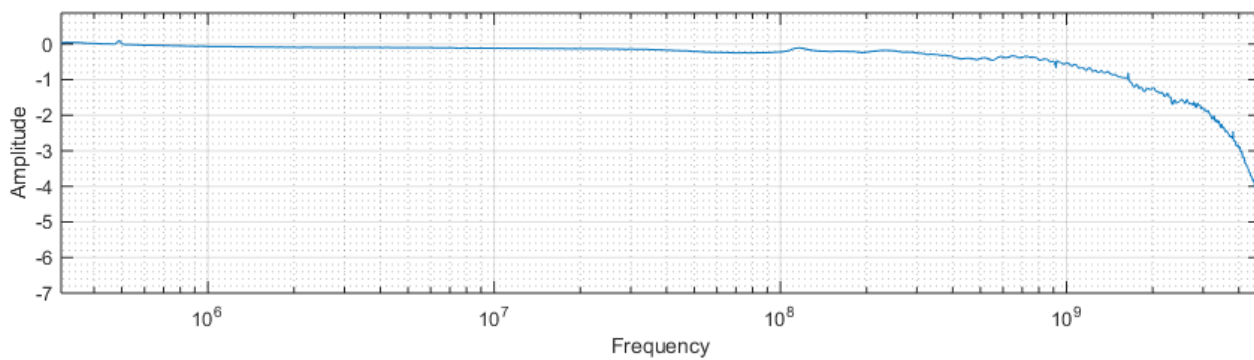

Figure 4: TPR4000 frequency response

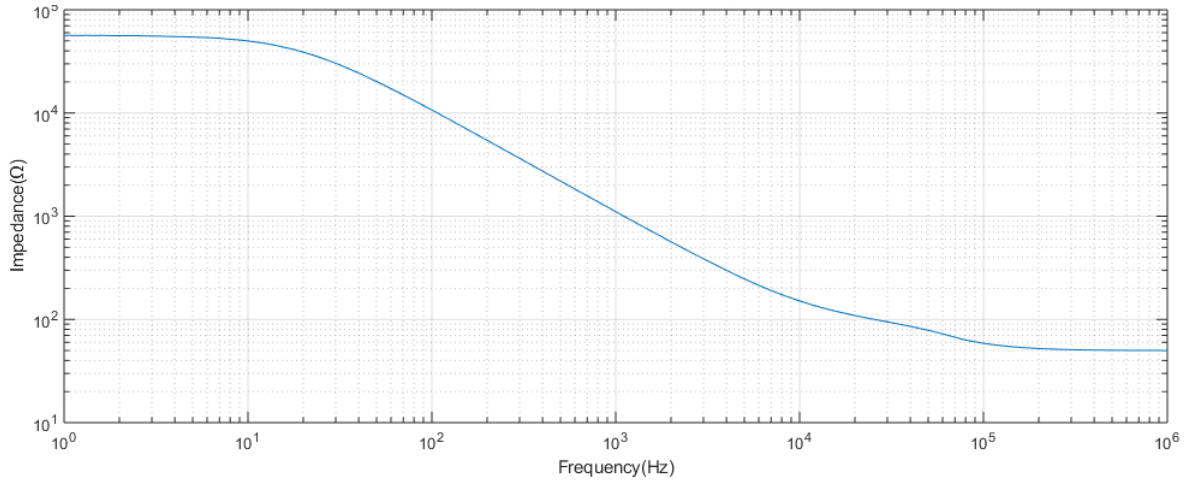
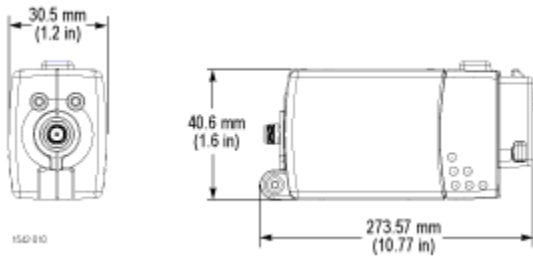

Figure 5: TPR1000 and TPR4000 input impedance and phase versus frequency

Table 4: Probe typical mechanical characteristics

Characteristic	Description
Dimensions, compensation box	85.1 mm × 40.6 mm × 30.5 mm (3.4 in × 1.6 in × 1.2 in)
Packaged weight	1.24 kg (2.7 lbs)



Nominal characteristics

Nominal characteristics describe guaranteed traits, but the traits do not have tolerance limits.

Table 5: Nominal electrical characteristics

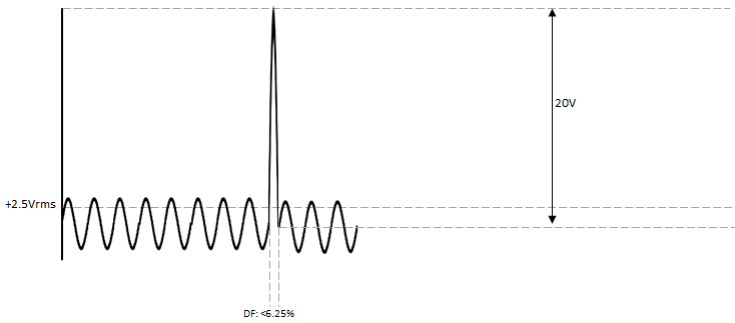
Characteristic	Description
Compatibility	Oscilloscopes equipped with the TekVPI interface
Instrument coupling	DC, LF-Reject
Input offset requestable range	± 60 V
Non-destructive input voltage range (AC frequency above 10 kHz)	2.5 VRMS, with peaks $\leq \pm 20$ V (DF 6.25%)
	 <p>The diagram shows a periodic waveform with a peak-to-peak voltage of 20V. The average voltage is labeled as +2.5Vrms. The duty factor is indicated as DF: 6.25%.</p>
Input connector on Comp box	SMA-female jack
Output connector on cable	SMA-male plug
DUT connector on standard cable	MMCX-male plug
DUT connector on optional cable	SMA-male plug SMP-female jack
Insulation voltage rating	± 30 V RMS (AC) ± 42 V Peak (pk-pk) ± 60 V DC (DC)

Accessory characteristics

Specifications for the TPR1000 and TPR4000 accessories fall into two categories: warranted and typical characteristics.

Table 6: Accessory electrical characteristics

Characteristic	Description
TPR4SIAFLEX and TPRSIACOAX (typical)	1 GHz (TPR1000) >3.5 GHz (TPR4000)
SMA to SMA cable (warranted)	1 GHz (TPR1000) 4 GHz (TPR4000)
MMCX to U.FL adapter (typical)	1 GHz (TPR1000) >2 GHz (TPR4000)
MMCX to square pin adapter (typical)	1 GHz (TPR1000) 1 GHz (TPR4000)

Table 6: Accessory electrical characteristics (cont.)

Characteristic	Description
2 M high temperature SMA to MMCX cable (typical)	1 GHz (TPR1000) >2 GHz (TPR4000)
TPR4BRWSR1G (typical)	>350 MHz with short ground
TPR4BRWSR1G (typical)	1 GHz with barrel adapter

Table 7: Accessory typical mechanical characteristics

Item number	Dimensions
Rigid Browser Tip	
Pogo Browser Tip	
Browser	
Browser Spring Ground	

Table 7: Accessory typical mechanical characteristics (cont.)

Item number	Dimensions
Browser Blade Ground	
Browser Alligator Ground	
TPRSIACOAX	
TPRSIAFLEX	
MMCX to U.FL adapter	

Table 7: Accessory typical mechanical characteristics (cont.)

Item number	Dimensions
1.3 m SMA to MMCX Cable	 <p>SMA</p> <p>1,3 m / 51,18 in</p> <p>MMCX</p>
1.3 m SMA to SMA Cable	 <p>SMA</p> <p>1,3 m / 51,18 in</p> <p>SMA</p>
2 m SMA to MMCX Cable	 <p>SMA</p> <p>2 meter / 78,74 in</p> <p>MMCX</p>
Browser to Square-pin adapter	 <p>[0,1 in]</p> <p>Ø 2,50 mm</p> <p>Ø 0,64 - 0,94 mm (2,04 - 3,70 in) and 0,64 mm (2,04 in) square pins</p> <p>[2,55in]</p> <p>65mm</p>

Table 7: Accessory typical mechanical characteristics (cont.)

Item number	Dimensions
-------------	------------

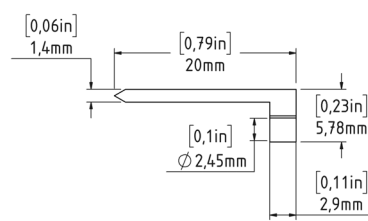
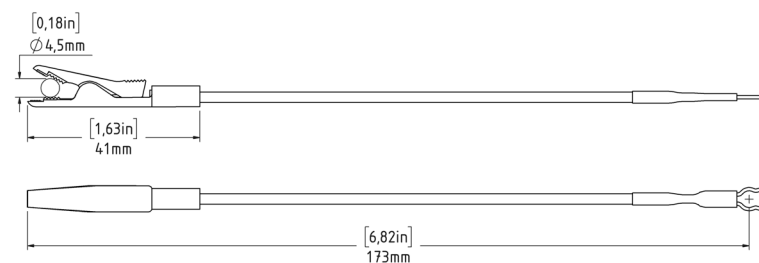
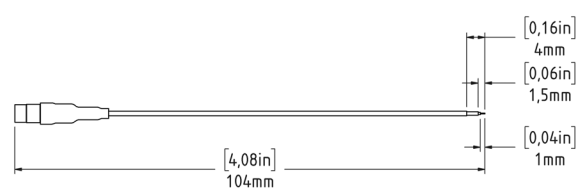
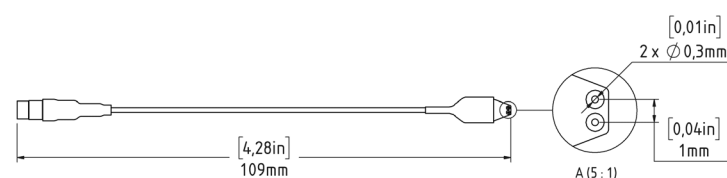
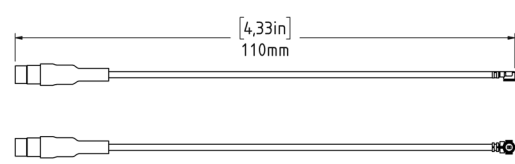
MMCX to Square-pin adapter	
----------------------------------	--

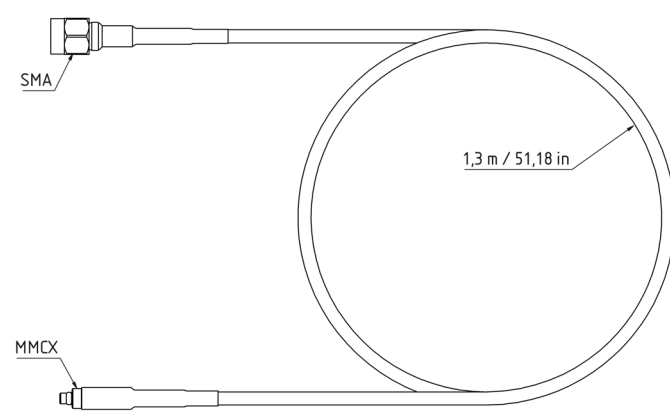
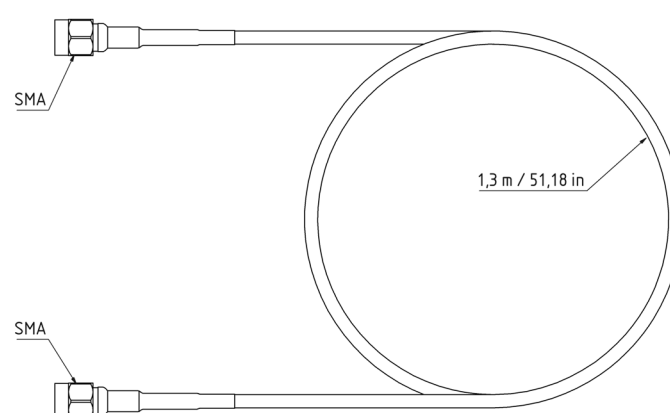
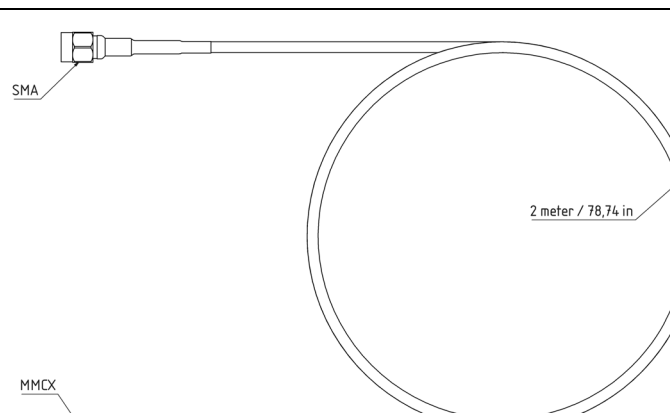
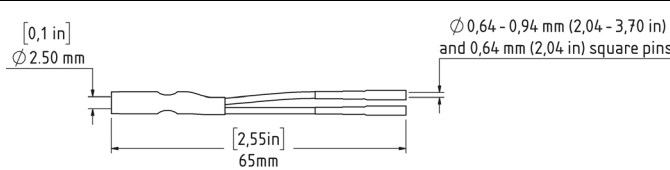
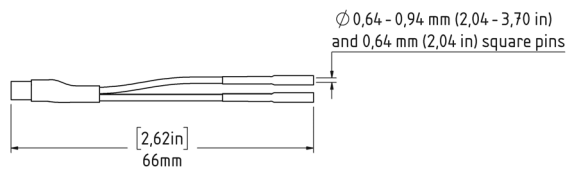

SMT Component Clip	
--------------------------	--

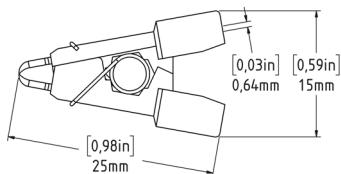

Performance verification

The procedures that follow verify the warranted specifications of the probe. The recommended calibration interval is one year. Perform the verification procedures in the order listed.

Equipment required

The following equipment is required for the performance verification procedures.

Table 8: Test equipment

Description and quantity	Performance requirement	Recommended example ¹
Oscilloscope	TekVPI Interface	Tektronix 6 Series MSO 8 Hz bandwidth option
DC calibration source		Keithley 2400 SMU
Digital multimeter (DMM)	Resistance, 0.1% accuracy	Keithley 2700 DMM
Network Analyzer		Tektronix VNA TTR506A 067-1701-XX with Calibration kit BN533828
TekVPI Calibration Verification adapter	TekVPI Interface	
SMA to BNC adapter	SMA male to BNC female	015-0554-XX
SMA to BNC adapter	SMA female to BNC male	015-0572-XX
SMA to SMA adapter	SMA male to SMA male	015-0551-XX
BNC-to-dual banana adapter (2)		103-0090-XX
BNC cable (2)	50 Ω , 0.76 m (30 in) length	012-0117-XX
Feed-thru termination	50 Ω , 1 GHz, $\pm 0.5 \Omega$	011-0049-XX
SMA cable for network analyzer	N to SMA-M 5 foot cable	012-1774-XX
SMA adapter for network analyzer	Type-N male to Type-SMA female	013-0406-XX
SMA torque wrench	5/16-in, 7 in-lb.	
SMA adapter wrench	7/32-in	

¹ Nine-digit part numbers (xxx-xxxx-xx) are Tektronix part numbers.

Equipment setup

Use the following procedures to set up and warm up the equipment to test the probe.

DC setup connection diagram

Use the DC setup diagram for the following performance checks.

- DC gain accuracy (See page 29.)
- DC input dynamic range (See page 31.)
- Input offset range and scale accuracy (See page 32.)

Tektronix 6 Series MSO

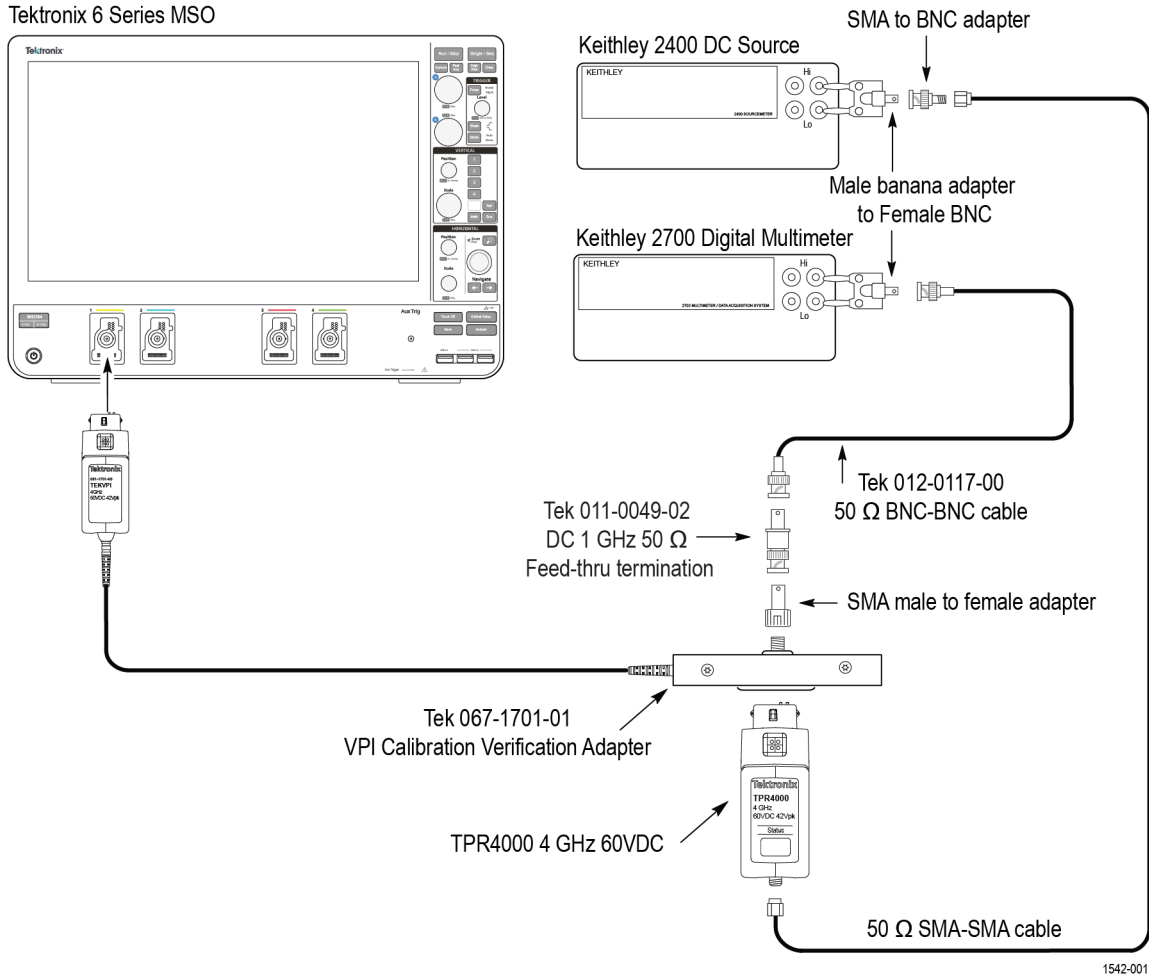

Figure 6: DC setup connection diagram

Analyzer setup connection diagram

Use the analyzer setup diagram for the analog bandwidth performance check. (See page 33.)

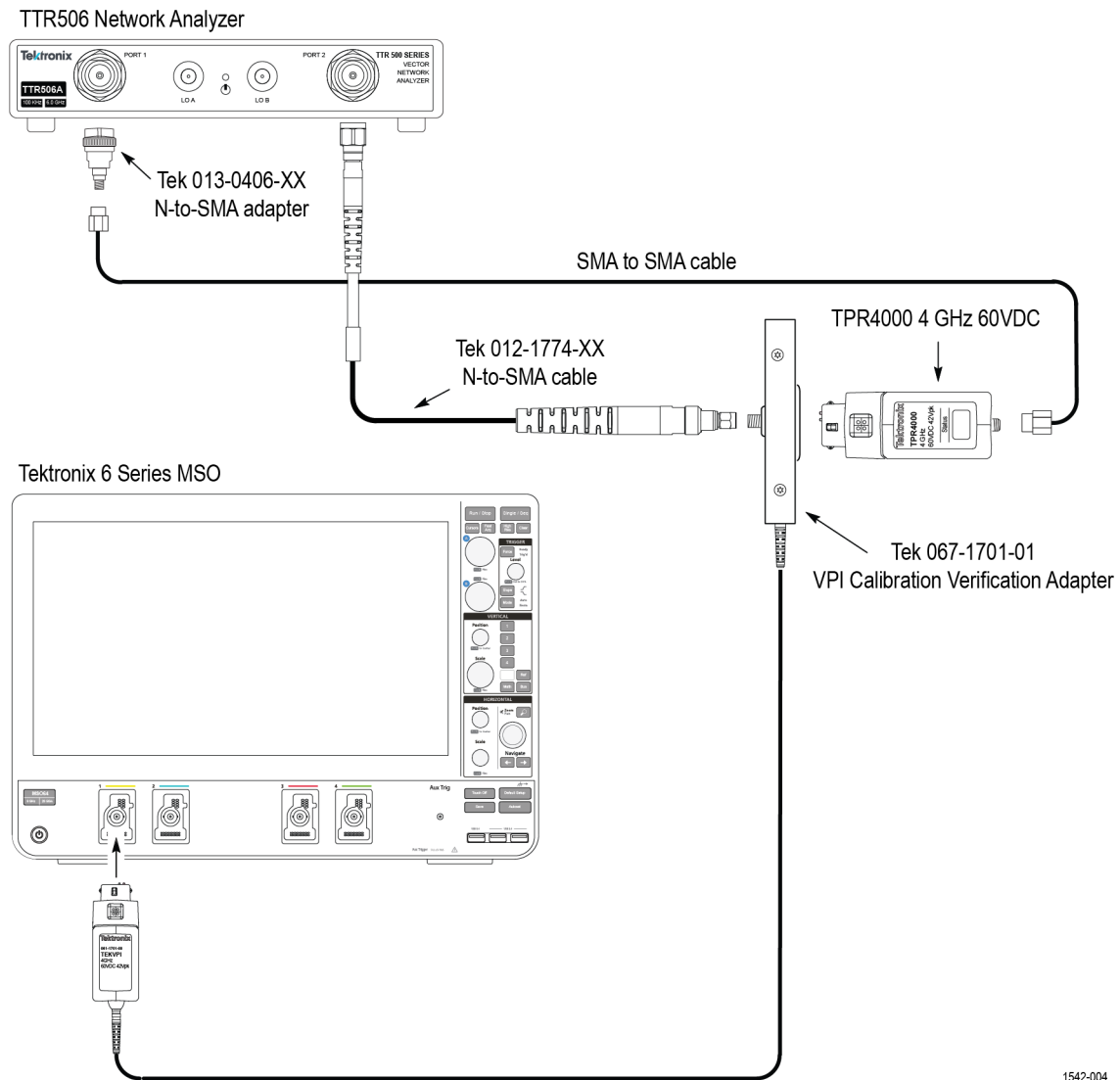

Figure 7: Analyzer setup connection diagram

1542-004

Warm up the test equipment

1. Turn on the TekVPI oscilloscope.
2. Connect the TekVPI Calibration/Verification adapter to the oscilloscope.
3. Connect the probe to the TekVPI Calibration Verification adapter and verify that the Status LED on the probe turns green.
4. Turn on the remaining test equipment.
5. Allow 20 minutes for the equipment to warm up.
6. Use the test record template to record the test results. (See page 34, *Test record*.)

Check the DC gain accuracy

Use the following test to check the DC gain accuracy of the probe.

1. Connect the test equipment as shown in the DC setup diagram. (See Figure 6.)
2. Before attaching the probe to the TekVPI Calibration Verification adapter, measure the resistance of the feed-thru termination with the DMM.
3. Record its value. If it is out of specification, replace the precision terminator before continuing the test.
4. Attach the probe to the TekVPI Calibration Verification adapter.
5. Ensure the probe offset is set to 0 V.
6. Set the digital multimeter (DMM) to the following settings.
 - DC Volts auto ranging
 - Filter mode on
 - Measurement rate slow
7. Set the DC source current limit to 3 mA.
8. Set the DC source to the first voltage level listed below. (See Table 9.)

NOTE. When using the DMM function in a Keithley SMU, turn on **FILTER** to reduce transient output values.

9. On the DMM measure the probe response and record the level in the Vout (measured) column in the following table.

Table 9: DC source voltage levels

Index	DC source voltage	Vout (measured)	Vout (linear fit)
-2	-640 mV		-512 mV
-1	-320 mV		-256 mV
0	0 mV		0 mV
1	320 mV		256 mV
2	640 mV		512 mV

10. Repeat steps 8 and 9 for each voltage level listed in the table. (See page 30, *DC gain measurement example*.)

11. Perform a linear fit of the measured data points in the preceding table and record the linear fit values in the table.
12. Divide the measured linear fit slope by the slope of the DC source voltage points. (See page 30, *DC gain measurement example*.)
13. Record the Measured Gain value in the test record. (See page 34.)

DC gain measurement example

1. The following table lists example measured values.

Table 10: Example DC gain measurements

Index	DC source voltage	Vout (measured)	Vout (linear fit)
-2	-640 mV	-513 mV	-514 mV
-1	-320 mV	-256 mV	-257 mV
0	0 mV	0.0009 mV	0 mV
1	320 mV	258 mV	257 mV
2	640 mV	515 mV	514 mV

2. The graph below show the plotted example values.

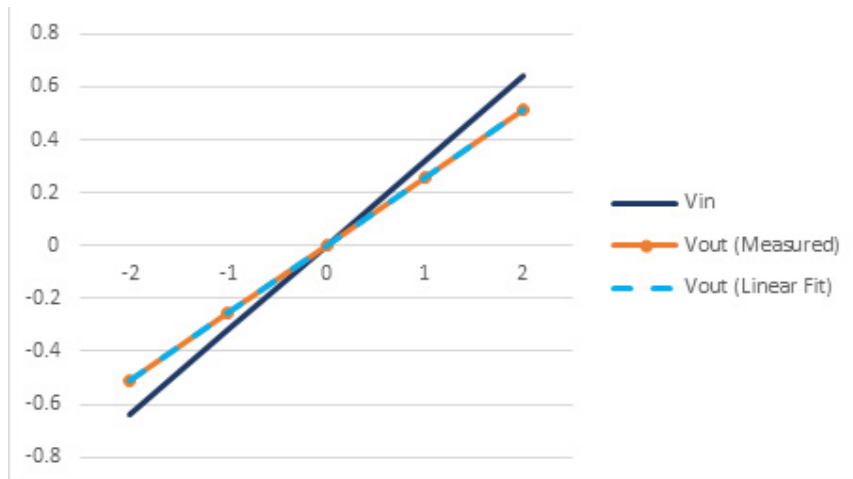

Figure 8: Example plot of measured values

The gain slope can either be obtained by using a spreadsheet to calculate the linear regression of the points, or graphically by hand. To obtain the gain slope graphically, carefully plot each measurement point on a rectangular coordinate system, the X axis is the DC source voltage and the Y axis is the measured DC output value. Using a straight edge, draw a line through the points, minimizing the error between the line and each point. The gain slope is taken by the slope of the drawn line (rise in Y divided by run in X), and the zero point error taken at the point at which the line crosses the Y axis. The DC output value can be predicted by the following equation: $V_{out}(n) = \text{gain slope} \times V_{in}(n) + \text{zeropoint}$

3. The following table shows the measured gain as calculated from the slopes of the plotted measured values.

Table 11: Example calculation of measured gain

Vout (linear fit) slope	Vin slope	Measured gain
0.257	0.320	0.803125

Check the DC input dynamic range

Use the following test to check the DC input dynamic range of the probe.

1. Connect the test equipment as shown in the DC setup diagram. (See Figure 6.)
2. Before attaching the probe to the TekVPI Calibration Verification adapter, measure the resistance of the feed-thru termination with the DMM.
3. Record its value. If it is out of specification, replace it before continuing the test.
4. Attach the probe to the TekVPI Calibration Verification adapter.
5. Ensure the probe offset is set to 0 V.
6. Set the DMM to DC Volts autoranging.

NOTE. When using the DMM function in a Keithley SMU, turn on *FILTER* to reduce transient output values.

7. Set the DC source current limit to 3 mA.
8. Set the source measure unit (SMU) to +1 V and record the output voltage on the DMM.
9. Set the source measure unit (SMU) to -1 V and record the output voltage on the DMM.
10. Using the readings taken in steps 8 and 9, apply the following equation to calculate the gain of the probe:

$$\text{Gain}_{\text{probe}} = V_{\text{source}} \div V_{\text{measured}}$$
11. Verify that the gain is at least 90% of the nominal gain range for each input by dividing it by the nominal expected gain and multiplying by 100:

$$100 \times \text{Gain}_{\text{measured}} \div \text{Gain}_{\text{nominal}}$$
12. If the value is >90%, then that limit of the dynamic range is verified.
13. Record results in test record.
14. Switch the probe to **DC Reject** mode.
15. While measuring the output, apply +1 V and -1 V to the input of the probe.
16. Ensure that output does not shift by more than 0.01 V during the test. Result is reported as Pass or Fail.
17. Return the probe to **DC Coupling** mode.
18. Record the result in the test record. (See page 34.)

Check the input offset range and scale accuracy

Use the following test to check the input offset range and scale accuracy of the probe.

1. Connect the test equipment as shown in the DC setup diagram. (See Figure 6.)
2. Before attaching the probe to the TekVPI Calibration Verification adapter, measure the resistance of the feed-thru termination with the DMM.
3. Record its value. If it is out of specification, replace it before continuing the test.
4. Attach the probe to the TekVPI Calibration Verification adapter.
5. Set the DMM to DC Volts autoranging.
6. Set the DC source current limit to 3 mA.
7. Sweep the DC source through the discrete points listed in the following table and set the probe offset range to the same set point using the Probe Setup window on the oscilloscope. Measure the probe response at each point with the DMM.

DC source voltage	Probe vertical offset setting
+12 V	+12 V
+1 V	+1 V
-1 V	-1 V
-12 V	-12 V

8. Record the result of each setting in the test record. (See page 34.)

Check the analog bandwidth

Use the following test to check the analog bandwidth of the probe.

1. Connect the test equipment as shown in the Analyzer setup diagram. (See Figure 7.)
2. Set the network analyzer to measure insertion loss (S21) in dB. Set the network analyzer to the following settings:
 - Power Level: –10 dBm
 - IF Bandwidth: 1 kHz
 - Sweep Type: Linear
 - Start Frequency: 300 kHz
 - Stop Frequency: 6 GHz
 - Number of points: 201
 - Set scale factor: 1 dB

For more information on setting up a network analyzer, use the following links:

- tek.com/how/making-basic-2-port-measurements-using-ttr500-vna
 - tek.com/how/how-calibrate-ttr500-vector-network-analyzer
3. Set up the network analyzer with a fresh 2-port SOLT calibration to the reference planes of the SMA side of network analyzer cable (port 2) and the SMA side of the SMA-to-N adapter (port 1).
 4. Place a marker on the S21 trace at the start frequency (300 kHz).
 5. Place a marker on the S21 trace at the probe bandwidth (1 GHz for TPR1000 or 4 GHz for TPR4000).
 6. Verify that the amplitude is greater than -3.97 dB (subtracting the 0.97 dB of probe attenuation range from the 3.97 dB target value yields the 3 dB limit).
 7. Record the result in the test record. (See page 34.)

Test record

Probe Model/Serial Number: _____ Certificate Number: _____

Temperature: _____ RH %: _____

Date of Calibration: _____ Technician: _____

Performance test	Minimum	Measured / calculated	Maximum
DC gain accuracy	0.792		0.808
DC input dynamic range	-1 V		NA
	NA		+1 V
DC reject function	Pass/Fail		
Input offset range and scale accuracy			
+12 V offset	-194 mV		194 mV
+1 V offset	-18 mV		18 mV
-1 V offset	-194 mV		194 mV
-12 V offset	-18 mV		18 mV
Analog bandwidth			
TPR1000	-3 dB		NA
TPR4000	-3 dB		NA

Maintenance

This section contains maintenance information for your probe.

Error condition

The TPR1000 and TPR4000 power rail probes are designed to work with all TekVPI-interface oscilloscopes and adapters. However, there may be some cases where all of the probe features may not work properly.

If the Status LED is red or flashing during or after probe power on, an internal probe diagnostic fault exists. Disconnect and reconnect the probe to restart the power-on diagnostic sequence. If the Status LED continues to be red or flashing for more than 30 seconds when the oscilloscope application is running, the probe is defective and must be returned to Tektronix for repair.

Replacement parts

There are no user replaceable parts within the probe. Refer to *Accessories* for a list of replaceable accessories for your probe.

Cleaning

Protect the probe from adverse weather conditions. The probe is not waterproof.



CAUTION. To prevent damage to the probe, do not expose it to sprays, liquids, or solvents. Avoid getting moisture inside the probe during exterior cleaning.

Do not use chemical cleaning agents; they may damage the probe. Avoid using chemicals that contain benzene, benzene, toluene, xylene, acetone, or similar solvents.

Clean the exterior surfaces of the probe with a dry, lint-free cloth or a soft-bristle brush. If dirt remains, use a soft cloth or swab dampened with a 75% isopropyl alcohol solution. A swab is useful for cleaning narrow spaces on the probe, use only enough solution to dampen the swab or cloth. Do not use abrasive compounds on any part of the probe.

Index

A

- Accessories
 - connect MMCX accessories, 7
 - connect solder-in
 - accessories, 7
 - optional, 12
 - standard, 11
 - using the optional 1 GHz
 - browse, 9
 - using the solder-pin installation
 - tool, 8
 - using the tripod, 9
 - Analog bandwidth
 - performance check, 33
 - AutoZero, 3

C

- Cleaning the probe, 35
- Connecting the probe, 2

D

- DC gain accuracy
 - performance check, 29
- DC input dynamic range
 - performance check, 31
- Documentation, vi

E

- Error condition, 35

F

- Features, viii
- Functional check, 4

G

- Ground lead
 - inductance, 16
 - selecting length, 15

I

- Indicators, 2
- Input offset range and scale accuracy
 - performance check, 32

L

- LED
 - Status, 2

M

- Maintenance, 35
- Menu Button, 3

O

- Offset, 7
- Operating considerations, 1
- Options, 14

P

- Performance verification, 26
 - equipment required, 26
 - equipment setup, 27
- Probe controls and indicators, 2

R

- Related documentation, vi
- Replacement parts, 35

S

- Specifications, 17
 - accessories, 21
 - nominal, 21
 - typical, 18
 - warranted, 17
- Status LED, 2, 35

T

- TekVPI, 2
- Test record, 34