

# R&S®UPZ

## Audio Switcher

### Operating Manual



1120.8610.14 – 05

The Operating Manual describes the following R&S®UPZ models and options:

- Model 1120.8004.02
- Model 1120.8004.03
- Model 1120.8004.12
- Model 1120.8004.13

© 2015 Rohde & Schwarz GmbH & Co. KG

Mueldorfstr. 15, 81671 Munich, Germany

Phone: +49 89 41 29 - 0

Fax: +49 89 41 29 12 164

E-mail: [info@rohde-schwarz.com](mailto:info@rohde-schwarz.com)

Internet: <http://www.rohde-schwarz.com>

Subject to change – Data without tolerance limits is not binding.

R&S® is a registered trademark of Rohde & Schwarz GmbH & Co. KG.

Trade names are trademarks of the owners.

The following abbreviations are used throughout this manual:

R&S®UPZ is abbreviated as R&S UPZ.

R&S®UPL is abbreviated as R&S UPL.

R&S®UPP is abbreviated as R&S UPP.

R&S®UPV is abbreviated as R&S UPV.

# Basic Safety Instructions

## Always read through and comply with the following safety instructions!

All plants and locations of the Rohde & Schwarz group of companies make every effort to keep the safety standards of our products up to date and to offer our customers the highest possible degree of safety. Our products and the auxiliary equipment they require are designed, built and tested in accordance with the safety standards that apply in each case. Compliance with these standards is continuously monitored by our quality assurance system. The product described here has been designed, built and tested in accordance with the EC Certificate of Conformity and has left the manufacturer's plant in a condition fully complying with safety standards. To maintain this condition and to ensure safe operation, you must observe all instructions and warnings provided in this manual. If you have any questions regarding these safety instructions, the Rohde & Schwarz group of companies will be happy to answer them.







Furthermore, it is your responsibility to use the product in an appropriate manner. This product is designed for use solely in industrial and laboratory environments or, if expressly permitted, also in the field and must not be used in any way that may cause personal injury or property damage. You are responsible if the product is used for any purpose other than its designated purpose or in disregard of the manufacturer's instructions. The manufacturer shall assume no responsibility for such use of the product.

The product is used for its designated purpose if it is used in accordance with its product documentation and within its performance limits (see data sheet, documentation, the following safety instructions). Using the product requires technical skills and, in some cases, a basic knowledge of English. It is therefore essential that only skilled and specialized staff or thoroughly trained personnel with the required skills be allowed to use the product. If personal safety gear is required for using Rohde & Schwarz products, this will be indicated at the appropriate place in the product documentation. Keep the basic safety instructions and the product documentation in a safe place and pass them on to the subsequent users.











Observing the safety instructions will help prevent personal injury or damage of any kind caused by dangerous situations. Therefore, carefully read through and adhere to the following safety instructions before and when using the product. It is also absolutely essential to observe the additional safety instructions on personal safety, for example, that appear in relevant parts of the product documentation. In these safety instructions, the word "product" refers to all merchandise sold and distributed by the Rohde & Schwarz group of companies, including instruments, systems and all accessories. For product-specific information, see the data sheet and the product documentation.

## Safety labels on products

The following safety labels are used on products to warn against risks and dangers.

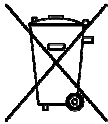
Symbol	Meaning	Symbol	Meaning
	Notice, general danger location Observe product documentation		ON/OFF supply voltage
	Caution when handling heavy equipment		Standby indication
	Danger of electric shock		Direct current (DC)

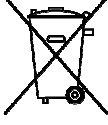
## Basic Safety Instructions

Symbol	Meaning	Symbol	Meaning
	Warning! Hot surface		Alternating current (AC)
	Protective conductor terminal		Direct/alternating current (DC/AC)
	Ground		Device fully protected by double (reinforced) insulation
	Ground terminal		EU labeling for batteries and accumulators For additional information, see section "Waste disposal/Environmental protection", item 1.
	Be careful when handling electrostatic sensitive devices		EU labeling for separate collection of electrical and electronic devices For additional information, see section "Waste disposal/Environmental protection", item 2.
	Warning! Laser radiation For additional information, see section "Operation", item 7.		

### Signal words and their meaning

The following signal words are used in the product documentation in order to warn the reader about risks and dangers.



Indicates a hazardous situation which, if not avoided, will result in death or serious injury.



Indicates a hazardous situation which, if not avoided, could result in death or serious injury.



Indicates a hazardous situation which, if not avoided, could result in minor or moderate injury.



Indicates information considered important, but not hazard-related, e.g. messages relating to property damage.

In the product documentation, the word ATTENTION is used synonymously.

These signal words are in accordance with the standard definition for civil applications in the European Economic Area. Definitions that deviate from the standard definition may also exist in other economic areas or military applications. It is therefore essential to make sure that the signal words described here are always used only in connection with the related product documentation and the related product. The use of signal words in connection with unrelated products or documentation can result in misinterpretation and in personal injury or material damage.

## Basic Safety Instructions

### Operating states and operating positions

*The product may be operated only under the operating conditions and in the positions specified by the manufacturer, without the product's ventilation being obstructed. If the manufacturer's specifications are not observed, this can result in electric shock, fire and/or serious personal injury or death. Applicable local or national safety regulations and rules for the prevention of accidents must be observed in all work performed.*

1. Unless otherwise specified, the following requirements apply to Rohde & Schwarz products: predefined operating position is always with the housing floor facing down, IP protection 2X, use only indoors, max. operating altitude 2000 m above sea level, max. transport altitude 4500 m above sea level. A tolerance of  $\pm 10\%$  shall apply to the nominal voltage and  $\pm 5\%$  to the nominal frequency, overvoltage category 2, pollution severity 2.
2. Do not place the product on surfaces, vehicles, cabinets or tables that for reasons of weight or stability are unsuitable for this purpose. Always follow the manufacturer's installation instructions when installing the product and fastening it to objects or structures (e.g. walls and shelves). An installation that is not carried out as described in the product documentation could result in personal injury or even death.
3. Do not place the product on heat-generating devices such as radiators or fan heaters. The ambient temperature must not exceed the maximum temperature specified in the product documentation or in the data sheet. Product overheating can cause electric shock, fire and/or serious personal injury or even death.

### Electrical safety

*If the information on electrical safety is not observed either at all or to the extent necessary, electric shock, fire and/or serious personal injury or death may occur.*

1. Prior to switching on the product, always ensure that the nominal voltage setting on the product matches the nominal voltage of the AC supply network. If a different voltage is to be set, the power fuse of the product may have to be changed accordingly.
2. In the case of products of safety class I with movable power cord and connector, operation is permitted only on sockets with a protective conductor contact and protective conductor.
3. Intentionally breaking the protective conductor either in the feed line or in the product itself is not permitted. Doing so can result in the danger of an electric shock from the product. If extension cords or connector strips are implemented, they must be checked on a regular basis to ensure that they are safe to use.
4. If there is no power switch for disconnecting the product from the AC supply network, or if the power switch is not suitable for this purpose, use the plug of the connecting cable to disconnect the product from the AC supply network. In such cases, always ensure that the power plug is easily reachable and accessible at all times. For example, if the power plug is the disconnecting device, the length of the connecting cable must not exceed 3 m. Functional or electronic switches are not suitable for providing disconnection from the AC supply network. If products without power switches are integrated into racks or systems, the disconnecting device must be provided at the system level.
5. Never use the product if the power cable is damaged. Check the power cables on a regular basis to ensure that they are in proper operating condition. By taking appropriate safety measures and carefully laying the power cable, ensure that the cable cannot be damaged and that no one can be hurt by, for example, tripping over the cable or suffering an electric shock.

## Basic Safety Instructions

6. The product may be operated only from TN/TT supply networks fuse-protected with max. 16 A (higher fuse only after consulting with the Rohde & Schwarz group of companies).
7. Do not insert the plug into sockets that are dusty or dirty. Insert the plug firmly and all the way into the socket provided for this purpose. Otherwise, sparks that result in fire and/or injuries may occur.
8. Do not overload any sockets, extension cords or connector strips; doing so can cause fire or electric shocks.
9. For measurements in circuits with voltages  $V_{\text{rms}} > 30 \text{ V}$ , suitable measures (e.g. appropriate measuring equipment, fuse protection, current limiting, electrical separation, insulation) should be taken to avoid any hazards.
10. Ensure that the connections with information technology equipment, e.g. PCs or other industrial computers, comply with the IEC60950-1/EN60950-1 or IEC61010-1/EN 61010-1 standards that apply in each case.
11. Unless expressly permitted, never remove the cover or any part of the housing while the product is in operation. Doing so will expose circuits and components and can lead to injuries, fire or damage to the product.
12. If a product is to be permanently installed, the connection between the protective conductor terminal on site and the product's protective conductor must be made first before any other connection is made. The product may be installed and connected only by a licensed electrician.
13. For permanently installed equipment without built-in fuses, circuit breakers or similar protective devices, the supply circuit must be fuse-protected in such a way that anyone who has access to the product, as well as the product itself, is adequately protected from injury or damage.
14. Use suitable overvoltage protection to ensure that no overvoltage (such as that caused by a bolt of lightning) can reach the product. Otherwise, the person operating the product will be exposed to the danger of an electric shock.
15. Any object that is not designed to be placed in the openings of the housing must not be used for this purpose. Doing so can cause short circuits inside the product and/or electric shocks, fire or injuries.
16. Unless specified otherwise, products are not liquid-proof (see also section "Operating states and operating positions", item 1). Therefore, the equipment must be protected against penetration by liquids. If the necessary precautions are not taken, the user may suffer electric shock or the product itself may be damaged, which can also lead to personal injury.
17. Never use the product under conditions in which condensation has formed or can form in or on the product, e.g. if the product has been moved from a cold to a warm environment. Penetration by water increases the risk of electric shock.
18. Prior to cleaning the product, disconnect it completely from the power supply (e.g. AC supply network or battery). Use a soft, non-linting cloth to clean the product. Never use chemical cleaning agents such as alcohol, acetone or diluents for cellulose lacquers.

## Operation

1. Operating the products requires special training and intense concentration. Make sure that persons who use the products are physically, mentally and emotionally fit enough to do so; otherwise, injuries or material damage may occur. It is the responsibility of the employer/operator to select suitable personnel for operating the products.

## Basic Safety Instructions

2. Before you move or transport the product, read and observe the section titled "Transport".
3. As with all industrially manufactured goods, the use of substances that induce an allergic reaction (allergens) such as nickel cannot be generally excluded. If you develop an allergic reaction (such as a skin rash, frequent sneezing, red eyes or respiratory difficulties) when using a Rohde & Schwarz product, consult a physician immediately to determine the cause and to prevent health problems or stress.
4. Before you start processing the product mechanically and/or thermally, or before you take it apart, be sure to read and pay special attention to the section titled "Waste disposal/Environmental protection", item 1.
5. Depending on the function, certain products such as RF radio equipment can produce an elevated level of electromagnetic radiation. Considering that unborn babies require increased protection, pregnant women must be protected by appropriate measures. Persons with pacemakers may also be exposed to risks from electromagnetic radiation. The employer/operator must evaluate workplaces where there is a special risk of exposure to radiation and, if necessary, take measures to avert the potential danger.
6. Should a fire occur, the product may release hazardous substances (gases, fluids, etc.) that can cause health problems. Therefore, suitable measures must be taken, e.g. protective masks and protective clothing must be worn.
7. Laser products are given warning labels that are standardized according to their laser class. Lasers can cause biological harm due to the properties of their radiation and due to their extremely concentrated electromagnetic power. If a laser product (e.g. a CD/DVD drive) is integrated into a Rohde & Schwarz product, absolutely no other settings or functions may be used as described in the product documentation. The objective is to prevent personal injury (e.g. due to laser beams).
8. EMC classes (in line with EN 55011/CISPR 11, and analogously with EN 55022/CISPR 22, EN 55032/CISPR 32)
  - Class A equipment:  
Equipment suitable for use in all environments except residential environments and environments that are directly connected to a low-voltage supply network that supplies residential buildings  
Note: Class A equipment is intended for use in an industrial environment. This equipment may cause radio disturbances in residential environments, due to possible conducted as well as radiated disturbances. In this case, the operator may be required to take appropriate measures to eliminate these disturbances.
  - Class B equipment:  
Equipment suitable for use in residential environments and environments that are directly connected to a low-voltage supply network that supplies residential buildings

### Repair and service

1. The product may be opened only by authorized, specially trained personnel. Before any work is performed on the product or before the product is opened, it must be disconnected from the AC supply network. Otherwise, personnel will be exposed to the risk of an electric shock.

## Basic Safety Instructions

- Adjustments, replacement of parts, maintenance and repair may be performed only by electrical experts authorized by Rohde & Schwarz. Only original parts may be used for replacing parts relevant to safety (e.g. power switches, power transformers, fuses). A safety test must always be performed after parts relevant to safety have been replaced (visual inspection, protective conductor test, insulation resistance measurement, leakage current measurement, functional test). This helps ensure the continued safety of the product.

### Batteries and rechargeable batteries/cells

*If the information regarding batteries and rechargeable batteries/cells is not observed either at all or to the extent necessary, product users may be exposed to the risk of explosions, fire and/or serious personal injury, and, in some cases, death. Batteries and rechargeable batteries with alkaline electrolytes (e.g. lithium cells) must be handled in accordance with the EN 62133 standard.*

- Cells must not be taken apart or crushed.
- Cells or batteries must not be exposed to heat or fire. Storage in direct sunlight must be avoided. Keep cells and batteries clean and dry. Clean soiled connectors using a dry, clean cloth.
- Cells or batteries must not be short-circuited. Cells or batteries must not be stored in a box or in a drawer where they can short-circuit each other, or where they can be short-circuited by other conductive materials. Cells and batteries must not be removed from their original packaging until they are ready to be used.
- Cells and batteries must not be exposed to any mechanical shocks that are stronger than permitted.
- If a cell develops a leak, the fluid must not be allowed to come into contact with the skin or eyes. If contact occurs, wash the affected area with plenty of water and seek medical aid.
- Improperly replacing or charging cells or batteries that contain alkaline electrolytes (e.g. lithium cells) can cause explosions. Replace cells or batteries only with the matching Rohde & Schwarz type (see parts list) in order to ensure the safety of the product.
- Cells and batteries must be recycled and kept separate from residual waste. Rechargeable batteries and normal batteries that contain lead, mercury or cadmium are hazardous waste. Observe the national regulations regarding waste disposal and recycling.

### Transport

- The product may be very heavy. Therefore, the product must be handled with care. In some cases, the user may require a suitable means of lifting or moving the product (e.g. with a lift-truck) to avoid back or other physical injuries.
- Handles on the products are designed exclusively to enable personnel to transport the product. It is therefore not permissible to use handles to fasten the product to or on transport equipment such as cranes, fork lifts, wagons, etc. The user is responsible for securely fastening the products to or on the means of transport or lifting. Observe the safety regulations of the manufacturer of the means of transport or lifting. Noncompliance can result in personal injury or material damage.
- If you use the product in a vehicle, it is the sole responsibility of the driver to drive the vehicle safely and properly. The manufacturer assumes no responsibility for accidents or collisions. Never use the product in a moving vehicle if doing so could distract the driver of the vehicle. Adequately secure the product in the vehicle to prevent injuries or other damage in the event of an accident.



## Instrucciones de seguridad elementales

### Waste disposal/Environmental protection

1. Specially marked equipment has a battery or accumulator that must not be disposed of with unsorted municipal waste, but must be collected separately. It may only be disposed of at a suitable collection point or via a Rohde & Schwarz customer service center.
2. Waste electrical and electronic equipment must not be disposed of with unsorted municipal waste, but must be collected separately.  
Rohde & Schwarz GmbH & Co. KG has developed a disposal concept and takes full responsibility for take-back obligations and disposal obligations for manufacturers within the EU. Contact your Rohde & Schwarz customer service center for environmentally responsible disposal of the product.
3. If products or their components are mechanically and/or thermally processed in a manner that goes beyond their intended use, hazardous substances (heavy-metal dust such as lead, beryllium, nickel) may be released. For this reason, the product may only be disassembled by specially trained personnel. Improper disassembly may be hazardous to your health. National waste disposal regulations must be observed.
4. If handling the product releases hazardous substances or fuels that must be disposed of in a special way, e.g. coolants or engine oils that must be replenished regularly, the safety instructions of the manufacturer of the hazardous substances or fuels and the applicable regional waste disposal regulations must be observed. Also observe the relevant safety instructions in the product documentation. The improper disposal of hazardous substances or fuels can cause health problems and lead to environmental damage.

For additional information about environmental protection, visit the Rohde & Schwarz website.

## Instrucciones de seguridad elementales

### ¡Es imprescindible leer y cumplir las siguientes instrucciones e informaciones de seguridad!

El principio del grupo de empresas Rohde & Schwarz consiste en tener nuestros productos siempre al día con los estándares de seguridad y de ofrecer a nuestros clientes el máximo grado de seguridad. Nuestros productos y todos los equipos adicionales son siempre fabricados y examinados según las normas de seguridad vigentes. Nuestro sistema de garantía de calidad controla constantemente que sean cumplidas estas normas. El presente producto ha sido fabricado y examinado según el certificado de conformidad de la UE y ha salido de nuestra planta en estado impecable según los estándares técnicos de seguridad. Para poder preservar este estado y garantizar un funcionamiento libre de peligros, el usuario deberá atenerse a todas las indicaciones, informaciones de seguridad y notas de alerta. El grupo de empresas Rohde & Schwarz está siempre a su disposición en caso de que tengan preguntas referentes a estas informaciones de seguridad.

Además queda en la responsabilidad del usuario utilizar el producto en la forma debida. Este producto está destinado exclusivamente al uso en la industria y el laboratorio o, si ha sido expresamente autorizado, para aplicaciones de campo y de ninguna manera deberá ser utilizado de modo que alguna persona/cosa pueda sufrir daño. El uso del producto fuera de sus fines definidos o sin tener en cuenta las instrucciones del fabricante queda en la responsabilidad del usuario. El fabricante no se hace en ninguna forma responsable de consecuencias a causa del mal uso del producto.













## Instrucciones de seguridad elementales

Se parte del uso correcto del producto para los fines definidos si el producto es utilizado conforme a las indicaciones de la correspondiente documentación del producto y dentro del margen de rendimiento definido (ver hoja de datos, documentación, informaciones de seguridad que siguen). El uso del producto hace necesarios conocimientos técnicos y ciertos conocimientos del idioma inglés. Por eso se debe tener en cuenta que el producto solo pueda ser operado por personal especializado o personas instruidas en profundidad con las capacidades correspondientes. Si fuera necesaria indumentaria de seguridad para el uso de productos de Rohde & Schwarz, encontraría la información debida en la documentación del producto en el capítulo correspondiente. Guarde bien las informaciones de seguridad elementales, así como la documentación del producto, y entréguelas a usuarios posteriores.



Tener en cuenta las informaciones de seguridad sirve para evitar en lo posible lesiones o daños por peligros de toda clase. Por eso es imprescindible leer detalladamente y comprender por completo las siguientes informaciones de seguridad antes de usar el producto, y respetarlas durante el uso del producto. Deberán tenerse en cuenta todas las demás informaciones de seguridad, como p. ej. las referentes a la protección de personas, que encontrarán en el capítulo correspondiente de la documentación del producto y que también son de obligado cumplimiento. En las presentes informaciones de seguridad se recogen todos los objetos que distribuye el grupo de empresas Rohde & Schwarz bajo la denominación de "producto", entre ellos también aparatos, instalaciones así como toda clase de accesorios. Los datos específicos del producto figuran en la hoja de datos y en la documentación del producto.

### Señalización de seguridad de los productos

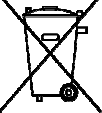
Las siguientes señales de seguridad se utilizan en los productos para advertir sobre riesgos y peligros.

Símbolo	Significado	Símbolo	Significado
	Aviso: punto de peligro general Observar la documentación del producto		Tensión de alimentación de PUESTA EN MARCHA / PARADA
	Atención en el manejo de dispositivos de peso elevado		Indicación de estado de espera (standby)
	Peligro de choque eléctrico		Corriente continua (DC)
	Advertencia: superficie caliente		Corriente alterna (AC)
	Conexión a conductor de protección		Corriente continua / Corriente alterna (DC/AC)
	Conexión a tierra		El aparato está protegido en su totalidad por un aislamiento doble (reforzado)
	Conexión a masa		Distintivo de la UE para baterías y acumuladores  Más información en la sección "Eliminación/protección del medio ambiente", punto 1.

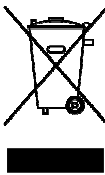
## Instrucciones de seguridad elementales

Símbolo	Significado	Símbolo	Significado
	Aviso: Cuidado en el manejo de dispositivos sensibles a la electrostática (ESD)		Distintivo de la UE para la eliminación por separado de dispositivos eléctricos y electrónicos  Más información en la sección "Eliminación/protección del medio ambiente", punto 2.
	Advertencia: rayo láser  Más información en la sección "Funcionamiento", punto 7.		

### Palabras de señal y su significado

En la documentación del producto se utilizan las siguientes palabras de señal con el fin de advertir contra riesgos y peligros.



Indica una situación de peligro que, si no se evita, causa lesiones graves o incluso la muerte.



Indica una situación de peligro que, si no se evita, puede causar lesiones graves o incluso la muerte.



Indica una situación de peligro que, si no se evita, puede causar lesiones leves o moderadas.



Indica información que se considera importante, pero no en relación con situaciones de peligro; p. ej., avisos sobre posibles daños materiales.

En la documentación del producto se emplea de forma sinónima el término CUIDADO.

Las palabras de señal corresponden a la definición habitual para aplicaciones civiles en el área económica europea. Pueden existir definiciones diferentes a esta definición en otras áreas económicas o en aplicaciones militares. Por eso se deberá tener en cuenta que las palabras de señal aquí descritas sean utilizadas siempre solamente en combinación con la correspondiente documentación del producto y solamente en combinación con el producto correspondiente. La utilización de las palabras de señal en combinación con productos o documentaciones que no les correspondan puede llevar a interpretaciones equivocadas y tener por consecuencia daños en personas u objetos.

### Estados operativos y posiciones de funcionamiento

*El producto solamente debe ser utilizado según lo indicado por el fabricante respecto a los estados operativos y posiciones de funcionamiento sin que se obstruya la ventilación. Si no se siguen las indicaciones del fabricante, pueden producirse choques eléctricos, incendios y/o lesiones graves con posible consecuencia de muerte. En todos los trabajos deberán ser tenidas en cuenta las normas nacionales y locales de seguridad del trabajo y de prevención de accidentes.*

## Instrucciones de seguridad elementales

1. Si no se convino de otra manera, es para los productos Rohde & Schwarz válido lo que sigue: como posición de funcionamiento se define por principio la posición con el suelo de la caja para abajo, modo de protección IP 2X, uso solamente en estancias interiores, utilización hasta 2000 m sobre el nivel del mar, transporte hasta 4500 m sobre el nivel del mar. Se aplicará una tolerancia de  $\pm 10\%$  sobre el voltaje nominal y de  $\pm 5\%$  sobre la frecuencia nominal. Categoría de sobrecarga eléctrica 2, índice de suciedad 2.
2. No sitúe el producto encima de superficies, vehículos, estantes o mesas, que por sus características de peso o de estabilidad no sean aptos para él. Siga siempre las instrucciones de instalación del fabricante cuando instale y asegure el producto en objetos o estructuras (p. ej. paredes y estantes). Si se realiza la instalación de modo distinto al indicado en la documentación del producto, se pueden causar lesiones o, en determinadas circunstancias, incluso la muerte.
3. No ponga el producto sobre aparatos que generen calor (p. ej. radiadores o calefactores). La temperatura ambiente no debe superar la temperatura máxima especificada en la documentación del producto o en la hoja de datos. En caso de sobrecalentamiento del producto, pueden producirse choques eléctricos, incendios y/o lesiones graves con posible consecuencia de muerte.

### Seguridad eléctrica

*Si no se siguen (o se siguen de modo insuficiente) las indicaciones del fabricante en cuanto a seguridad eléctrica, pueden producirse choques eléctricos, incendios y/o lesiones graves con posible consecuencia de muerte.*

1. Antes de la puesta en marcha del producto se deberá comprobar siempre que la tensión preseleccionada en el producto coincida con la de la red de alimentación eléctrica. Si es necesario modificar el ajuste de tensión, también se deberán cambiar en caso dado los fusibles correspondientes del producto.
2. Los productos de la clase de protección I con alimentación móvil y enchufe individual solamente podrán enchufarse a tomas de corriente con contacto de seguridad y con conductor de protección conectado.
3. Queda prohibida la interrupción intencionada del conductor de protección, tanto en la toma de corriente como en el mismo producto. La interrupción puede tener como consecuencia el riesgo de que el producto sea fuente de choques eléctricos. Si se utilizan cables alargadores o regletas de enchufe, deberá garantizarse la realización de un examen regular de los mismos en cuanto a su estado técnico de seguridad.
4. Si el producto no está equipado con un interruptor para desconectarlo de la red, o bien si el interruptor existente no resulta apropiado para la desconexión de la red, el enchufe del cable de conexión se deberá considerar como un dispositivo de desconexión. El dispositivo de desconexión se debe poder alcanzar fácilmente y debe estar siempre bien accesible. Si, p. ej., el enchufe de conexión a la red es el dispositivo de desconexión, la longitud del cable de conexión no debe superar 3 m). Los interruptores selectores o electrónicos no son aptos para el corte de la red eléctrica. Si se integran productos sin interruptor en bastidores o instalaciones, se deberá colocar el interruptor en el nivel de la instalación.
5. No utilice nunca el producto si está dañado el cable de conexión a red. Compruebe regularmente el correcto estado de los cables de conexión a red. Asegúrese, mediante las medidas de protección y de instalación adecuadas, de que el cable de conexión a red no pueda ser dañado o de que nadie pueda ser dañado por él, p. ej. al tropezar o por un choque eléctrico.

## Instrucciones de seguridad elementales

6. Solamente está permitido el funcionamiento en redes de alimentación TN/TT aseguradas con fusibles de 16 A como máximo (utilización de fusibles de mayor amperaje solo previa consulta con el grupo de empresas Rohde & Schwarz).
7. Nunca conecte el enchufe en tomas de corriente sucias o llenas de polvo. Introduzca el enchufe por completo y fuertemente en la toma de corriente. La no observación de estas medidas puede provocar chispas, fuego y/o lesiones.
8. No sobrecargue las tomas de corriente, los cables alargadores o las regletas de enchufe ya que esto podría causar fuego o choques eléctricos.
9. En las mediciones en circuitos de corriente con una tensión  $U_{\text{eff}} > 30 \text{ V}$  se deberán tomar las medidas apropiadas para impedir cualquier peligro (p. ej. medios de medición adecuados, seguros, limitación de tensión, corte protector, aislamiento etc.).
10. Para la conexión con dispositivos informáticos como un PC o un ordenador industrial, debe comprobarse que éstos cumplan los estándares IEC60950-1/EN60950-1 o IEC61010-1/EN 61010-1 válidos en cada caso.
11. A menos que esté permitido expresamente, no retire nunca la tapa ni componentes de la carcasa mientras el producto esté en servicio. Esto pone a descubierto los cables y componentes eléctricos y puede causar lesiones, fuego o daños en el producto.
12. Si un producto se instala en un lugar fijo, se deberá primero conectar el conductor de protección fijo con el conductor de protección del producto antes de hacer cualquier otra conexión. La instalación y la conexión deberán ser efectuadas por un electricista especializado.
13. En el caso de dispositivos fijos que no estén provistos de fusibles, interruptor automático ni otros mecanismos de seguridad similares, el circuito de alimentación debe estar protegido de modo que todas las personas que puedan acceder al producto, así como el producto mismo, estén a salvo de posibles daños.
14. Todo producto debe estar protegido contra sobretensión (debida p. ej. a una caída del rayo) mediante los correspondientes sistemas de protección. Si no, el personal que lo utilice quedará expuesto al peligro de choque eléctrico.
15. No debe introducirse en los orificios de la caja del aparato ningún objeto que no esté destinado a ello. Esto puede producir cortocircuitos en el producto y/o puede causar choques eléctricos, fuego o lesiones.
16. Salvo indicación contraria, los productos no están impermeabilizados (ver también el capítulo "Estados operativos y posiciones de funcionamiento", punto 1). Por eso es necesario tomar las medidas necesarias para evitar la entrada de líquidos. En caso contrario, existe peligro de choque eléctrico para el usuario o de daños en el producto, que también pueden redundar en peligro para las personas.
17. No utilice el producto en condiciones en las que pueda producirse o ya se hayan producido condensaciones sobre el producto o en el interior de éste, como p. ej. al desplazarlo de un lugar frío a otro caliente. La entrada de agua aumenta el riesgo de choque eléctrico.
18. Antes de la limpieza, desconecte por completo el producto de la alimentación de tensión (p. ej. red de alimentación o batería). Realice la limpieza de los aparatos con un paño suave, que no se deshilache. No utilice bajo ningún concepto productos de limpieza químicos como alcohol, acetona o diluyentes para lacas nitrocelulósicas.

## Instrucciones de seguridad elementales

### Funcionamiento

1. El uso del producto requiere instrucciones especiales y una alta concentración durante el manejo. Debe asegurarse que las personas que manejen el producto estén a la altura de los requerimientos necesarios en cuanto a aptitudes físicas, psíquicas y emocionales, ya que de otra manera no se pueden excluir lesiones o daños de objetos. El empresario u operador es responsable de seleccionar el personal usuario apto para el manejo del producto.
2. Antes de desplazar o transportar el producto, lea y tenga en cuenta el capítulo "Transporte".
3. Como con todo producto de fabricación industrial no puede quedar excluida en general la posibilidad de que se produzcan alergias provocadas por algunos materiales empleados —los llamados alérgenos (p. ej. el níquel)—. Si durante el manejo de productos Rohde & Schwarz se producen reacciones alérgicas, como p. ej. irritaciones cutáneas, estornudos continuos, enrojecimiento de la conjuntiva o dificultades respiratorias, debe avisarse inmediatamente a un médico para investigar las causas y evitar cualquier molestia o daño a la salud.
4. Antes de la manipulación mecánica y/o térmica o el desmontaje del producto, debe tenerse en cuenta imprescindiblemente el capítulo "Eliminación/protección del medio ambiente", punto 1.
5. Ciertos productos, como p. ej. las instalaciones de radiocomunicación RF, pueden a causa de su función natural, emitir una radiación electromagnética aumentada. Deben tomarse todas las medidas necesarias para la protección de las mujeres embarazadas. También las personas con marcapasos pueden correr peligro a causa de la radiación electromagnética. El empresario/operador tiene la obligación de evaluar y señalar las áreas de trabajo en las que exista un riesgo elevado de exposición a radiaciones.
6. Tenga en cuenta que en caso de incendio pueden desprenderse del producto sustancias tóxicas (gases, líquidos etc.) que pueden generar daños a la salud. Por eso, en caso de incendio deben usarse medidas adecuadas, como p. ej. máscaras antigás e indumentaria de protección.
7. Los productos con láser están provistos de indicaciones de advertencia normalizadas en función de la clase de láser del que se trate. Los rayos láser pueden provocar daños de tipo biológico a causa de las propiedades de su radiación y debido a su concentración extrema de potencia electromagnética. En caso de que un producto Rohde & Schwarz contenga un producto láser (p. ej. un lector de CD/DVD), no debe usarse ninguna otra configuración o función aparte de las descritas en la documentación del producto, a fin de evitar lesiones (p. ej. debidas a irradiación láser).
8. Clases de compatibilidad electromagnética (conforme a EN 55011 / CISPR 11; y en analogía con EN 55022 / CISPR 22, EN 55032 / CISPR 32)
  - Aparato de clase A:  
Aparato adecuado para su uso en todos los entornos excepto en los residenciales y en aquellos conectados directamente a una red de distribución de baja tensión que suministra corriente a edificios residenciales.  
Nota: Los aparatos de clase A están destinados al uso en entornos industriales. Estos aparatos pueden causar perturbaciones radioeléctricas en entornos residenciales debido a posibles perturbaciones guiadas o radiadas. En este caso, se le podrá solicitar al operador que tome las medidas adecuadas para eliminar estas perturbaciones.
  - Aparato de clase B:  
Aparato adecuado para su uso en entornos residenciales, así como en aquellos conectados directamente a una red de distribución de baja tensión que suministra corriente a edificios residenciales.

## Instrucciones de seguridad elementales

### Reparación y mantenimiento

1. El producto solamente debe ser abierto por personal especializado con autorización para ello. Antes de manipular el producto o abrirlo, es obligatorio desconectarlo de la tensión de alimentación, para evitar toda posibilidad de choque eléctrico.
2. El ajuste, el cambio de partes, el mantenimiento y la reparación deberán ser efectuadas solamente por electricistas autorizados por Rohde & Schwarz. Si se reponen partes con importancia para los aspectos de seguridad (p. ej. el enchufe, los transformadores o los fusibles), solamente podrán ser sustituidos por partes originales. Después de cada cambio de partes relevantes para la seguridad deberá realizarse un control de seguridad (control a primera vista, control del conductor de protección, medición de resistencia de aislamiento, medición de la corriente de fuga, control de funcionamiento). Con esto queda garantizada la seguridad del producto.

### Baterías y acumuladores o celdas

*Si no se siguen (o se siguen de modo insuficiente) las indicaciones en cuanto a las baterías y acumuladores o celdas, pueden producirse explosiones, incendios y/o lesiones graves con posible consecuencia de muerte. El manejo de baterías y acumuladores con electrolitos alcalinos (p. ej. celdas de litio) debe seguir el estándar EN 62133.*

1. No deben desmontarse, abrirse ni triturarse las celdas.
2. Las celdas o baterías no deben someterse a calor ni fuego. Debe evitarse el almacenamiento a la luz directa del sol. Las celdas y baterías deben mantenerse limpias y secas. Limpiar las conexiones sucias con un paño seco y limpio.
3. Las celdas o baterías no deben cortocircuitarse. Es peligroso almacenar las celdas o baterías en estuches o cajones en cuyo interior puedan cortocircuitarse por contacto recíproco o por contacto con otros materiales conductores. No deben extraerse las celdas o baterías de sus embalajes originales hasta el momento en que vayan a utilizarse.
4. Las celdas o baterías no deben someterse a impactos mecánicos fuertes indebidos.
5. En caso de falta de estanqueidad de una celda, el líquido vertido no debe entrar en contacto con la piel ni los ojos. Si se produce contacto, lavar con agua abundante la zona afectada y avisar a un médico.
6. En caso de cambio o recarga inadecuados, las celdas o baterías que contienen electrolitos alcalinos (p. ej. las celdas de litio) pueden explotar. Para garantizar la seguridad del producto, las celdas o baterías solo deben ser sustituidas por el tipo Rohde & Schwarz correspondiente (ver lista de recambios).
7. Las baterías y celdas deben reciclarse y no deben tirarse a la basura doméstica. Las baterías o acumuladores que contienen plomo, mercurio o cadmio deben tratarse como residuos especiales. Respete en esta relación las normas nacionales de eliminación y reciclaje.

### Transporte

1. El producto puede tener un peso elevado. Por eso es necesario desplazarlo o transportarlo con precaución y, si es necesario, usando un sistema de elevación adecuado (p. ej. una carretilla elevadora), a fin de evitar lesiones en la espalda u otros daños personales.

## Instrucciones de seguridad elementales

2. Las asas instaladas en los productos sirven solamente de ayuda para el transporte del producto por personas. Por eso no está permitido utilizar las asas para la sujeción en o sobre medios de transporte como p. ej. grúas, carretillas elevadoras de horquilla, carros etc. Es responsabilidad suya fijar los productos de manera segura a los medios de transporte o elevación. Para evitar daños personales o daños en el producto, siga las instrucciones de seguridad del fabricante del medio de transporte o elevación utilizado.
3. Si se utiliza el producto dentro de un vehículo, recae de manera exclusiva en el conductor la responsabilidad de conducir el vehículo de manera segura y adecuada. El fabricante no asumirá ninguna responsabilidad por accidentes o colisiones. No utilice nunca el producto dentro de un vehículo en movimiento si esto pudiera distraer al conductor. Asegure el producto dentro del vehículo debidamente para evitar, en caso de un accidente, lesiones u otra clase de daños.

### Eliminación/protección del medio ambiente

1. Los dispositivos marcados contienen una batería o un acumulador que no se debe desechar con los residuos domésticos sin clasificar, sino que debe ser recogido por separado. La eliminación se debe efectuar exclusivamente a través de un punto de recogida apropiado o del servicio de atención al cliente de Rohde & Schwarz.
2. Los dispositivos eléctricos usados no se deben desechar con los residuos domésticos sin clasificar, sino que deben ser recogidos por separado. Rohde & Schwarz GmbH & Co.KG ha elaborado un concepto de eliminación de residuos y asume plenamente los deberes de recogida y eliminación para los fabricantes dentro de la UE. Para desechar el producto de manera respetuosa con el medio ambiente, diríjase a su servicio de atención al cliente de Rohde & Schwarz.
3. Si se trabaja de manera mecánica y/o térmica cualquier producto o componente más allá del funcionamiento previsto, pueden liberarse sustancias peligrosas (povos con contenido de metales pesados como p. ej. plomo, berilio o níquel). Por eso el producto solo debe ser desmontado por personal especializado con formación adecuada. Un desmontaje inadecuado puede ocasionar daños para la salud. Se deben tener en cuenta las directivas nacionales referentes a la eliminación de residuos.
4. En caso de que durante el trato del producto se formen sustancias peligrosas o combustibles que deban tratarse como residuos especiales (p. ej. refrigerantes o aceites de motor con intervalos de cambio definidos), deben tenerse en cuenta las indicaciones de seguridad del fabricante de dichas sustancias y las normas regionales de eliminación de residuos. Tenga en cuenta también en caso necesario las indicaciones de seguridad especiales contenidas en la documentación del producto. La eliminación incorrecta de sustancias peligrosas o combustibles puede causar daños a la salud o daños al medio ambiente.

Se puede encontrar más información sobre la protección del medio ambiente en la página web de Rohde & Schwarz.



# Quality management and environmental management



## Sehr geehrter Kunde,

Sie haben sich für den Kauf eines Rohde&Schwarz Produktes entschieden. Sie erhalten damit ein nach modernsten Fertigungsmethoden hergestelltes Produkt. Es wurde nach den Regeln unserer Qualitäts- und Umweltmanagementsysteme entwickelt, gefertigt und geprüft. Rohde&Schwarz ist unter anderem nach den Managementsystemen ISO9001 und ISO14001 zertifiziert.

## Der Umwelt verpflichtet

- Energie-effiziente, RoHS-konforme Produkte
- Kontinuierliche Weiterentwicklung nachhaltiger Umweltkonzepte
- ISO14001-zertifiziertes Umweltmanagementsystem

## Dear customer,

You have decided to buy a Rohde&Schwarz product. This product has been manufactured using the most advanced methods. It was developed, manufactured and tested in compliance with our quality management and environmental management systems. Rohde&Schwarz has been certified, for example, according to the ISO9001 and ISO14001 management systems.

## Environmental commitment

- Energy-efficient products
- Continuous improvement in environmental sustainability
- ISO14001-certified environmental management system

## Cher client,

Vous avez choisi d'acheter un produit Rohde&Schwarz. Vous disposez donc d'un produit fabriqué d'après les méthodes les plus avancées. Le développement, la fabrication et les tests de ce produit ont été effectués selon nos systèmes de management de qualité et de management environnemental. La société Rohde&Schwarz a été homologuée, entre autres, conformément aux systèmes de management ISO9001 et ISO14001.

## Engagement écologique

- Produits à efficience énergétique
- Amélioration continue de la durabilité environnementale
- Système de management environnemental certifié selon ISO14001

# Customer Support

## Technical support – where and when you need it

For quick, expert help with any Rohde & Schwarz equipment, contact one of our Customer Support Centers. A team of highly qualified engineers provides telephone support and will work with you to find a solution to your query on any aspect of the operation, programming or applications of Rohde & Schwarz equipment.

## Up-to-date information and upgrades

To keep your instrument up-to-date and to be informed about new application notes related to your instrument, please send an e-mail to the Customer Support Center stating your instrument and your wish. We will take care that you will get the right information.

### Europe, Africa, Middle East

Phone +49 89 4129 12345  
[customersupport@rohde-schwarz.com](mailto:customersupport@rohde-schwarz.com)

### North America

Phone 1-888-TEST-RSA (1-888-837-8772)  
[customer.support@rsa.rohde-schwarz.com](mailto:customer.support@rsa.rohde-schwarz.com)

### Latin America

Phone +1-410-910-7988  
[customersupport.la@rohde-schwarz.com](mailto:customersupport.la@rohde-schwarz.com)

### Asia/Pacific

Phone +65 65 13 04 88  
[customersupport.asia@rohde-schwarz.com](mailto:customersupport.asia@rohde-schwarz.com)

### China

Phone +86-800-810-8228 /  
+86-400-650-5896  
[customersupport.china@rohde-schwarz.com](mailto:customersupport.china@rohde-schwarz.com)



# Table of Contents

<b>Figures</b> .....	<b>3</b>
<b>Tables</b> .....	<b>4</b>
<b>Documentation Overview</b> .....	<b>5</b>
<b>Conventions Used in the Documentation</b> .....	<b>6</b>
<b>1 Putting into Operation</b> .....	<b>7</b>
<b>1.1 Overview</b> .....	<b>7</b>
<b>1.2 Front and Rear Panel</b> .....	<b>8</b>
1.2.1 Input Switcher .....	8
1.2.2 Output Switcher .....	9
<b>1.3 Putting into Operation</b> .....	<b>10</b>
1.3.1 Unpacking and Checking the Instrument .....	11
1.3.2 Placing or Mounting the Instrument .....	11
1.3.3 Mounting the Instrument in a Rack .....	12
1.3.4 Connecting the Instrument to the AC Supply .....	12
1.3.5 Power Fuses .....	13
1.3.6 Switching the Instrument On and Off .....	14
1.3.7 EMC Safety Precautions .....	14
<b>1.4 Connection to the Test Setup</b> .....	<b>15</b>
1.4.1 Connecting the Inputs and Outputs .....	15
1.4.2 Control of the R&S UPZ .....	17
1.4.3 Connecting the Control Lines .....	17
1.4.4 Installing the USB Driver .....	17
1.4.4.1 Installation on the R&S UPP/UPV with Windows XP Operating System .....	18
1.4.4.2 Installation on the R&S UPP/UPV with Windows 7 Operating System .....	21
1.4.4.3 Making USB Connection to the R&S UPZ .....	25
1.4.5 Connection to the R&S UPL .....	27
1.4.6 Connection to the R&S UPV .....	28
1.4.7 Connection to the R&S UPP .....	29
1.4.8 Switcher Cascading .....	30
1.4.9 Setting the Instrument Address .....	31

<b>2</b>	<b>Manual Operation .....</b>	<b>33</b>
2.1	Control elements.....	33
2.2	Display Elements .....	33
2.3	Link Establishment using an R&S UPL .....	34
2.4	R&S UPL Default Setting.....	36
2.5	Operating the R&S UPZ from the R&S UPL .....	37
2.6	Link Establishment using an R&S UPV .....	40
2.7	Link Establishment using an R&S UPV and USB .....	42
2.8	Link Establishment using an R&S UPV and RS232 .....	43
2.9	R&S UPV Default Setting .....	44
2.10	Operating the R&S UPZ from the R&S UPV .....	44
2.11	Link Establishment using an R&S UPP .....	47
2.12	R&S UPP Default Setting .....	49
2.13	Operating the R&S UPZ from the R&S UPP .....	50
2.14	Remote Control of R&S UPZ.....	53
<b>3</b>	<b>Applications .....</b>	<b>54</b>
3.1	Input Switcher .....	54
3.2	Output switcher.....	55
3.3	Combined Use of Input and Output Switcher .....	57
<b>4</b>	<b>Remote Control via an External PC.....</b>	<b>58</b>
4.1	Brief Instructions .....	58
4.2	Hardware Interfaces .....	58
4.2.1	RS-232-C interface .....	58
4.2.2	Characteristics of the Interface .....	59
4.2.3	Signal lines.....	59
4.2.4	Transmission Parameters.....	60
4.3	Special Channel Settings.....	61
<b>5</b>	<b>Maintenance .....</b>	<b>63</b>
5.1	Mechanical Maintenance.....	63
5.2	Electrical Maintenance .....	64
5.3	Storage and Packaging .....	64

## Figures

Fig. 1-1	Basic circuit diagram of R&S UPZ .....	7
Fig. 1-2	Front panel of input switcher .....	8
Fig. 1-3	Rear panel of input switcher .....	8
Fig. 1-4	Front panel of output switcher .....	9
Fig. 1-5	Rear panel of output switcher .....	9
Fig. 1-6	AC supply voltage selector .....	13
Fig. 1-7	Power unit with fuse holder open .....	13
Fig. 1-8	Connection of R&S UPZ to an Audio Analyzer.....	15
Fig. 1-9	Pin assignment of XLR socket and plug.....	15
Fig. 1-10	Switcher cascading .....	16
Fig. 1-11	Connecting R&S UPL and R&S UPZ using a RS232-Extension Cord ...	27
Fig. 1-12	Connecting R&S UPV and R&S UPZ using a RS232-Extension Cord or a USB Device Cable .....	28
Fig. 1-13	Connecting R&S UPP and R&S UPZ using USB Device Cable.....	29
Fig. 1-14	Cascading .....	30
Fig. 1-15	R&S UPZ addressing .....	31
Fig. 2-1	Option Panel: R&S UPL.....	34
Fig. 2-2	Switcher Panel: R&S UPL .....	34
Fig. 2-3	Default-Setting: R&S UPL.....	36
Fig. 2-4	Channel setting via the R&S UPL.....	37
Fig. 2-5	Error Message: R&S UPL.....	38
Fig. 2-6	Tracking selection: R&S UPL .....	38
Fig. 2-7	Complete tracking feature: R&S UPL.....	39
Fig. 2-8	Config Panel: R&S UPV .....	40
Fig. 2-9	COM Interface: R&S UPV.....	41
Fig. 2-10	Opening the Switcher Panel: R&S UPV.....	41
Fig. 2-11	Choosing the Interface: R&S UPV .....	41
Fig. 2-12	USB Serial Port: R&S UPV .....	42
Fig. 2-13	COM Port Scan: R&S UPV .....	42
Fig. 2-14	Interface selection: R&S UPV .....	42
Fig. 2-15	Switcher Connection Establishment: R&S UPV .....	43
Fig. 2-16	Switcher Panel: R&S UPV .....	43

Fig. 2-17	Default-Setting: R&S UPV.....	44
Fig. 2-18	Channel setting via the R&S UPV.....	44
Fig. 2-19	Error Message: R&S UPV.....	45
Fig. 2-20	Tracking selection: R&S UPV .....	46
Fig. 2-21	USB Serial Port: R&S UPP .....	47
Fig. 2-22	Opening the Switcher Panel: R&S UPP.....	47
Fig. 2-23	COM Port Scan: R&S UPP .....	48
Fig. 2-24	Switcher Connection Establishment: R&S UPP .....	48
Fig. 2-25	Switcher Panel: R&S UPP .....	48
Fig. 2-26	Default-Setting: R&S UPP.....	49
Fig. 2-27	Channel setting via the R&S UPP.....	50
Fig. 2-28	Error Message: R&S UPP.....	51
Fig. 2-29	Tracking selection: R&S UPP .....	51
Fig. 3-1	Use of input switcher .....	54
Fig. 3-2	Use of output switcher .....	55
Fig. 3-3	Use of input and output switcher .....	57
Fig. 4-1	Pin assignment of the D-sub connectors.....	59

## Tables

Table 1-1	Operating the R&S UPZ at other AC supplies .....	12
Table 1-2	Relationship device address ↔ channel number .....	32
Table 2-1	List of settings and IEC/IEEE-bus commands: R&S UPL.....	40
Table 2-2	List of settings and IEC/IEEE-bus commands: R&S UPV .....	46
Table 2-3	List of settings and IEC/IEEE-bus commands: R&S UPP .....	52
Table 2-4	Possibilities of remote controlling.....	53
Table 4-1	Control commands and queries for the R&S UPZ .....	60

# Documentation Overview

The user documentation for the R&S UPZ is divided as follows:

- Operating Manual
- Service Manual



The current user documentation is also available on the internet: <http://www.rohde-schwarz.com/product/UPZ.html>

---

## Operating Manual

The printed operating manual is also provided in PDF format on the CD-ROM. It provides a complete reference of the instrument functions and remote control. It includes information about maintenance of the instrument. It is subdivided into the following chapters:

- Putting into Operation
- Connection to the Test Setup
- Manual Operation
- Applications
- Remote Control and Remote Control Interfaces
- Maintenance

## Service Manual

The service manual is provided in PDF format on the CD-ROM. It informs on how to check compliance with rated specifications, on instrument function, repair, troubleshooting and fault elimination. It contains all information required for the maintenance of R&S UPP by exchanging modules. In addition it describes how to install options. It is subdivided into the following chapters:

- Performance Test
- Repair
- Documents

# Conventions Used in the Documentation

The following conventions are used throughout the R&S UPZ Operating Manual:

## Typographical conventions

Convention	Description
"Graphical user interface elements"	All names of graphical user interface elements both on the screen and on the front and rear panels, such as dialog boxes, softkeys, menus, options, buttons etc., are enclosed by quotation marks.
"KEYS"	Key names are written in capital letters and enclosed by quotation marks.
<i>Input</i>	Input to be entered by the user is displayed in italics.
File names, commands, program code	File names, commands, coding samples and screen output are distinguished by their font.
"Links"	Links that you can click are displayed in blue font.
"References"	References to other parts of the documentation are enclosed by quotation marks.

## Other conventions

- **Remote commands:** Remote commands may include abbreviations to simplify input. In the description of such commands, all parts that have to be entered are written in capital letters. Additional text in lower-case characters is for information only.



# 1 Putting into Operation

## 1.1 Overview

A switcher of the R&S UPZ family can combine or distribute audio signals. Each R&S UPZ thus extends an Audio Analyzer to eight additional input or output channels. The R&S UPZ is available as **input** or **output** switcher.

An **input** switcher allows the user to switch up to eight different DUTs (**D**evices **U**nder **T**est) to two analyzer inputs without any replugging.

An **output** switcher can distribute the generator channels delivered by an Audio Analyzer to up to eight DUTs (**D**evices **U**nder **T**est).

Fig. 1-1 shows the basic circuit diagram, the signal direction from top to bottom representing an **input** switcher and from bottom to top an **output** switcher (the  $600\ \Omega$  resistors are contained only in the output switcher and provide a defined source impedance to a connected DUT when the output channel is not activated).

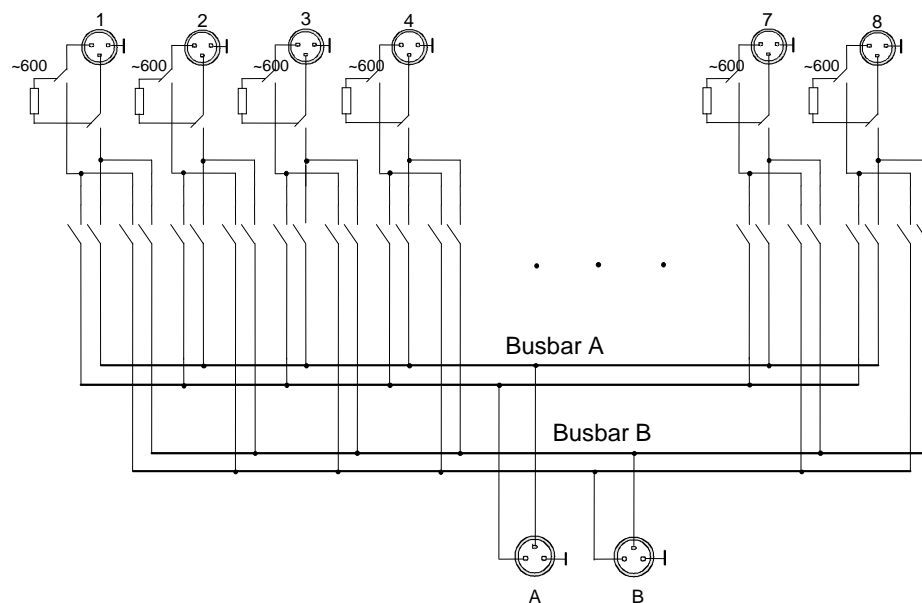

**Fig. 1-1 Basic circuit diagram of R&S UPZ**

It is not possible to switch the same channel simultaneously to the two busbars neither with the input nor the output switcher.

Thus, the **input switcher** prevents a connected generator from suddenly being subject to double load, which might result in unexpected level variations or poor data, especially when low-impedance loads are connected.

In the **output switcher**, this measure prevents two generator outputs from working against each other and being short-circuited in the case of very low internal resistances. This is particularly important with outputs that are not short-circuit-proof.

## 1.2 Front and Rear Panel

### 1.2.1 Input Switcher

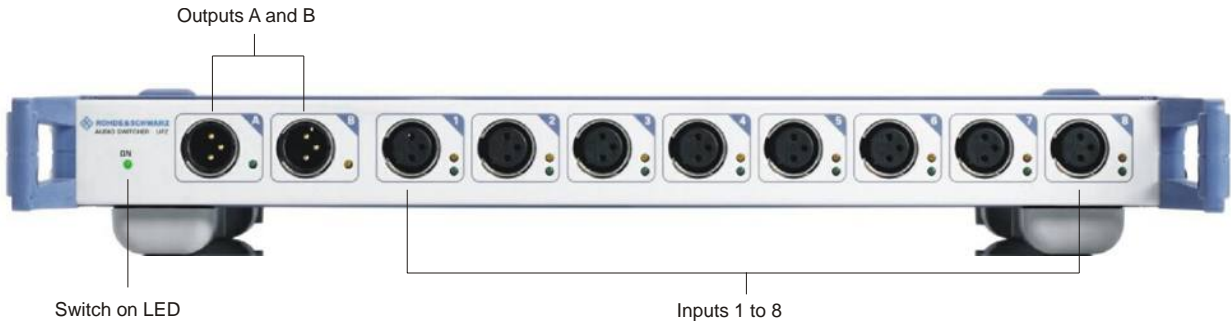

**Fig. 1-2 Front panel of input switcher**

Starting from variant .12, each R&S UPZ is equipped with an additional USB device connection at the rear panel which allows alternative control via USB.

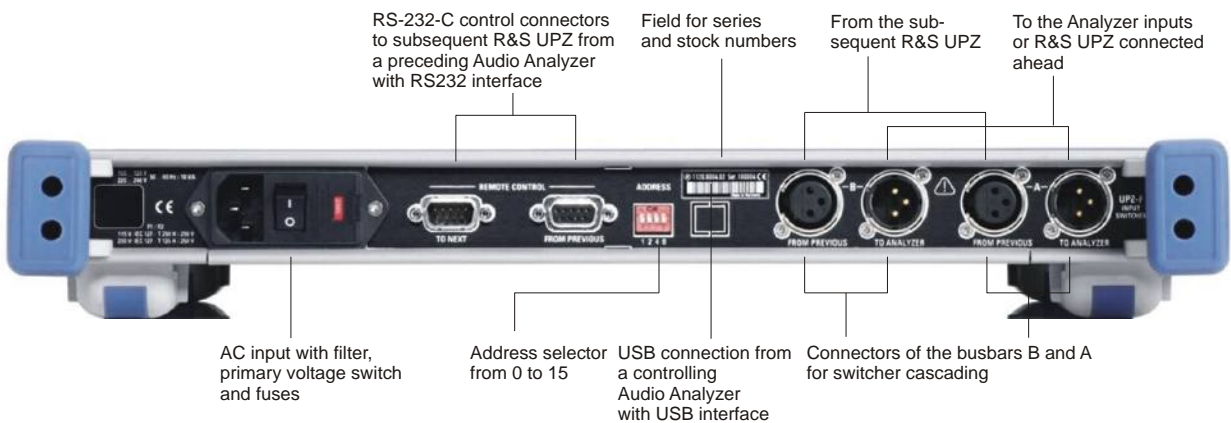

**Fig. 1-3 Rear panel of input switcher**

### 1.2.2 Output Switcher

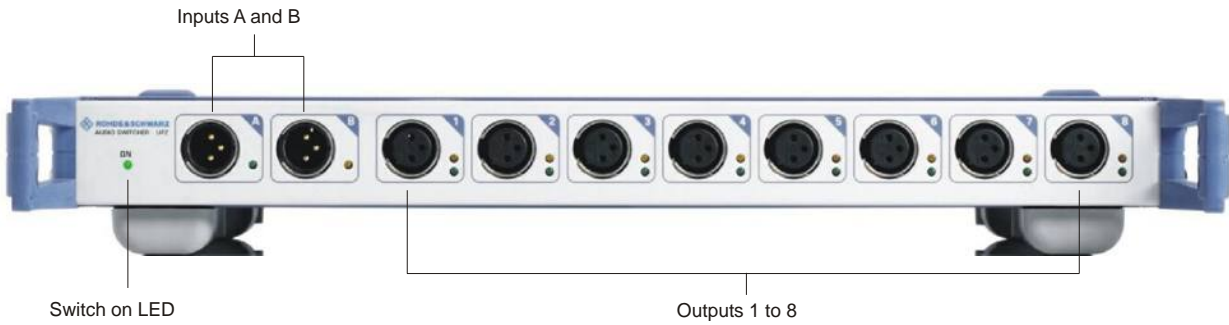

**Fig. 1-4 Front panel of output switcher**

Starting from variant .13, each R&S UPZ is equipped with an additional USB device connection at the rear panel which allows alternative control via USB.

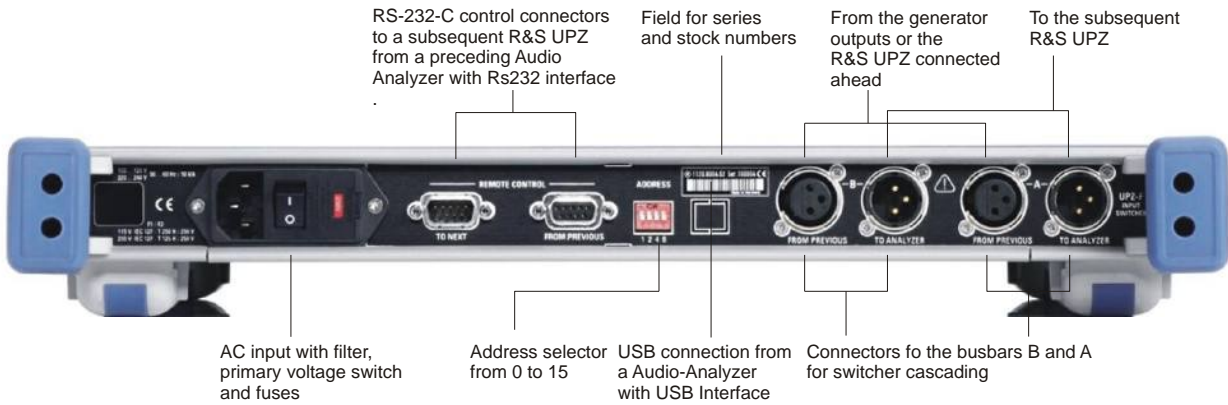

**Fig. 1-5 Rear panel of output switcher**

## 1.3 Putting into Operation

This section describes the basic steps to be taken when setting up the R&S UPZ for the first time.

---

### **WARNING**

#### **Shock hazard**

Do not open the instrument casing. As a rule, normal operation of the instrument does not require opening the casing. Observe the general safety instructions and regulations at the beginning of the manual.

---

---

### **NOTICE**

#### **Risk of instrument damage**

Before switching on the instrument, make sure that the following conditions are met:

- Instrument casing is closed and all fasteners are tightened.
- All fan openings are unobstructed and the airflow perforations are unimpeded. The minimum distance from the wall is 10 cm.
- The instrument is dry and shows no sign of condensation.
- The instrument is operated in the horizontal position on an even surface.
- The ambient temperature does not exceed the range specified in the data sheet.
- Signal levels at the input connectors are all within the specified ranges.
- Signal outputs are correctly connected and are not overloaded.

Note that the general safety instructions also contain information on operating conditions that will prevent damage to the instrument. The instrument's data sheet may contain additional operating conditions.

Failure to meet these conditions may cause damage to the instrument or other devices in the test setup.

---

---

### **NOTICE**

#### **Risk of electrostatic discharge**

Protect the work area against electrostatic discharge to avoid damage to electronic components in the modules. For details, refer to the safety instructions at the beginning of this manual.

---



### EMI impact on measurement results

Electromagnetic interference (EMI) can affect the measurement results. To avoid any impact, make sure that the following conditions are met:

- Use suitable double-shielded cables.
- Do not use USB connecting cables exceeding 1 m in length.
- Use only USB devices that remain within the permissible EMI limits.

## 1.3.1 Unpacking and Checking the Instrument

To remove the instrument from its packaging and check the equipment for completeness proceed as follows:

1. Pull off the polyethylene protection pads from the instrument's rear feet and then carefully remove the pads from the instrument handles at the front.
2. Pull off the corrugated cardboard cover that protects the rear of the instrument.
3. Carefully unthread the corrugated cardboard cover at the front that protects the instrument handles and remove it.
4. Check the equipment for completeness using the delivery note and the accessory lists for the various items.
5. Check the instrument for any damage. If there is damage, immediately contact the carrier who delivered the instrument. Make sure not to discard the box and packing material.



### Packing material

Retain the original packing material. If the instrument needs to be transported or shipped at a later date, you can use the material to prevent control elements and connectors from being damaged.

## 1.3.2 Placing or Mounting the Instrument

Permissible operating position of the R&S UPZ: horizontal

Operating the instrument in vertical position is not recommended since the narrow casing (1 HU) may fall over.



For problem-free operation of the instrument, observe the following:

- Observe the permissible ambient temperature as specified in the data sheet.
- Avoid condensation. In case condensation has occurred, dry the instrument prior to switching it on.

### 1.3.3 Mounting the Instrument in a Rack

The instrument can be mounted in 19" racks by means of Rack Adapter ZZA-111 (order No. 1096.3254.00). The installation is described in the mounting instructions for the rack adapter.

#### NOTICE

##### Risk of instrument damage

For rack installation, make sure that all fan openings are unobstructed and that the airflow perforations are unimpeded. This helps to prevent the instrument from overheating.

### 1.3.4 Connecting the Instrument to the AC Supply

The R&S UPZ can be connected to single-phase AC supply with a nominal voltage of 115 V and 230 V and nominal frequencies of 50 Hz to 60 Hz.



The R&S UPZ should be set to the correct AC supply voltage at the rear. The values of the all-pole fuse should be adapted accordingly.

The table below shows different AC supply voltages and the required voltage selector setting.

**Table 1-1 Operating the R&S UPZ at other AC supplies**

Nominal Voltage	Voltage selector setting	Tolerance of the instrument
100 V	115 V	90 V to 132 V
120 V	115 V	
220 V	230 V	196 V to 264 V
240 V	230 V	

The instrument is connected to the AC supply by means of the connecting line supplied. The ON LED lights up as soon as the connection is established and the instrument is switched on.

**Note:** The instrument is in compliance with safety class EN61010-1. Connect the instrument only to a socket with earthing contact.

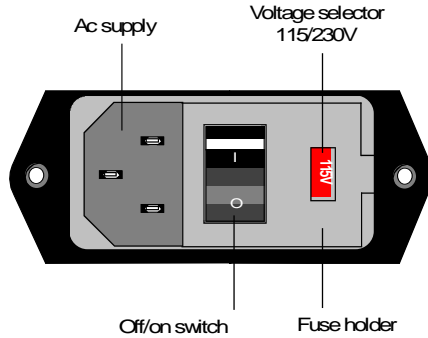

Fig. 1-6 AC supply voltage selector

### 1.3.5 Power Fuses

The R&S UPZ has an all-pole protection comprising two fuses of the type IEC127-T125H/250V (for 230 V) or IEC127T250H/250V (for 115 V). They are accommodated in the removable fuse holder next to the power switch on the rear panel. For replacing the fuses, first remove the power cable from the R&S UPZ. The fuse holder can then be opened using a screwdriver and pulled out. Use only fuses of the specified type as a replacement.

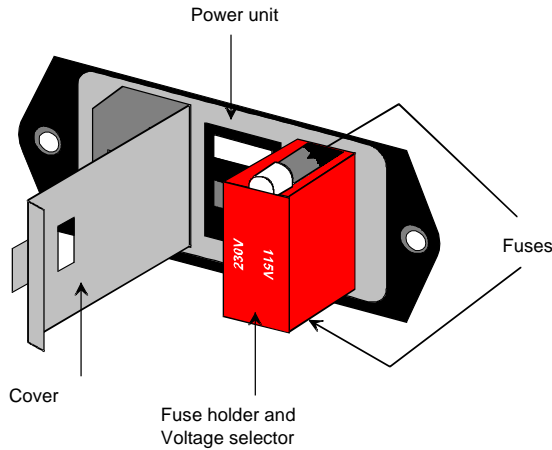

Fig. 1-7 Power unit with fuse holder open

### 1.3.6 Switching the Instrument On and Off

Before switching on the instrument for the first time, check if the correct AC supply voltage is set. If it is not correct, proceed as follows: (see also [Fig. 1-7](#), on page 13).

- Disconnect power cable.
- Open cover of voltage selector using a screwdriver.
- Pull out fuse holder and insert fuses with the required value (included in the accessories supplied) → 125 mA, slow-blow, for 230 V or 250 mA, slow-blow, for 115 V
- Slide in fuse holder in the correct position so that the AC supply voltage setting can be seen through the window.
- Close the cover

The audio switchers of the R&S UPZ series have a rear-panel power switch, which allows all-pole disconnection from the AC supply.

The instrument is on when the ON LED lights up. Immediately after power-up no channel is selected, i.e. all channel LEDs are off. A routine is run in the R&S UPZ, which initializes the serial interface, the internal timers and the ports.

If the user interface of the controlling Audio Analyzer is opened, an address search is initiated starting with address 0. All R&S UPZ receive this query almost simultaneously. The internal processor in each switcher connected then reads its own address set via the coding switch, the board ID and the switcher type (input or output). Each R&S UPZ whose address and type correspond to the query returns the internally stored configuration to the Audio Analyzer. If a R&S UPZ compatible with the preselected channels is found, the corresponding setting commands are sent to this R&S UPZ. The associated LEDs light up.

### 1.3.7 EMC Safety Precautions

To prevent electromagnetic interference, the instrument must be closed when in use. Only suitably shielded signal and control cables may be used. In particular, ensure that the lines connected to the D-sub connectors are well shielded.



## 1.4 Connection to the Test Setup

### 1.4.1 Connecting the Inputs and Outputs

Two "busbar" connectors **A** and **B** for connection to the Audio Analyzer are available on the front panel.

The male XLR connectors of the **input switcher** busbar are connected to the analyzer inputs and the female XLR connectors of the **output switcher** busbar are connected to a R&S Audio

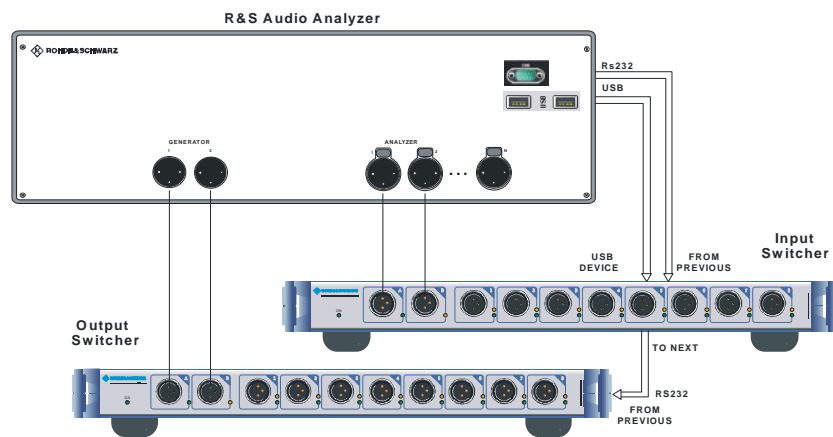
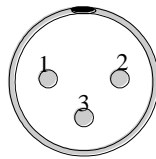
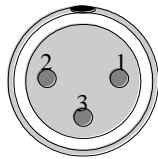

**Fig. 1-8** Connection of R&S UPZ to an Audio Analyzer

In professional audio applications, all signal lines are generally balanced in order to avoid interference coupling. For this reason, the internal signal lines of Audio Switchers R&S UPZ are balanced and equipped with the XLR connectors commonly used in studio engineering. The pin assignment is defined and shown in Fig. 1-9 on page 15.

XLR socket

XLR plug



Analyzer input

Generator output

Pin 1: Ground Pin 2: Signal line Pin 3: Signal feedback

**Fig. 1-9** Pin assignment of XLR socket and plug

**NOTICE**

Electrostatic discharges must be avoided with XLR connectors in order to prevent damages to the relays in the signal path.

It is sufficient that the user "earths" himself, i.e. to establish contact with ground, before connecting a cable to the R&S UPZ.

The busbars of the R&S UPZ allow several switchers to be interconnected to form a large system. The signal lines at the rear of the R&S UPZ are interconnected via the XLR connectors according to [Fig. 1-10](#) on page 16.

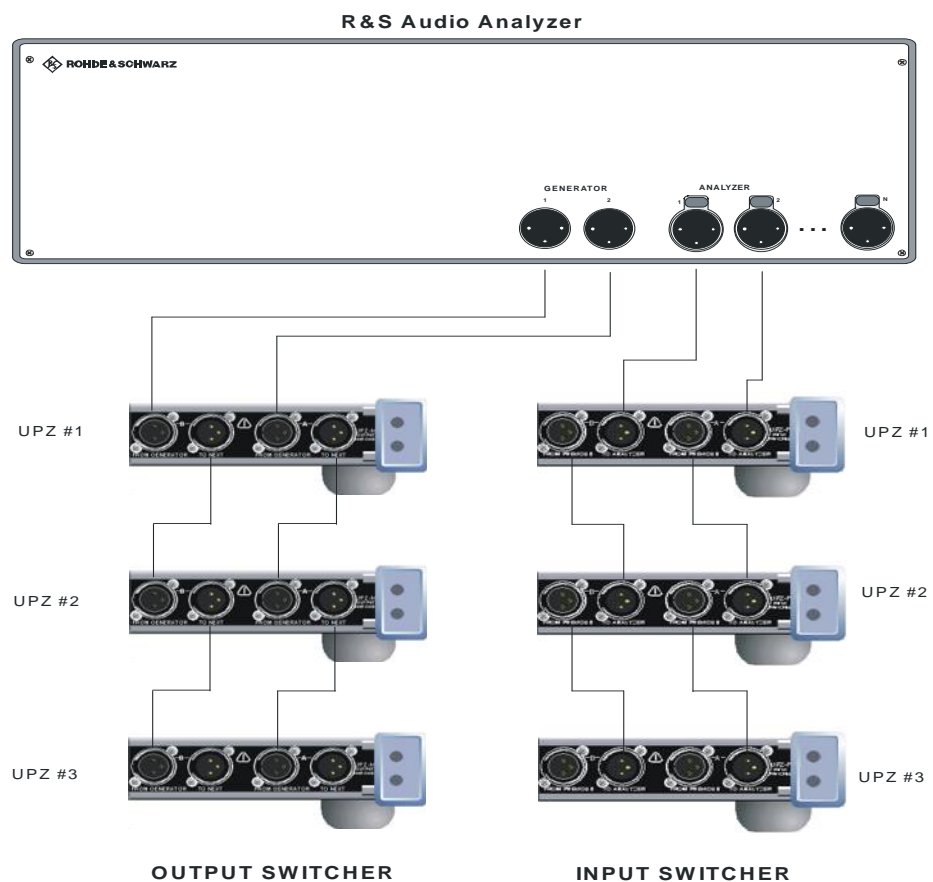

**Fig. 1-10 Switcher cascading**

As shown in [Fig. 1-10](#), the signals of several are combined at the rear-panel XLR connectors. These connectors are equivalent to busbar connectors A and B on the R&S UPZ front panel. The two switchers directly connected to the Audio Analyzer can therefore be connected to the device from the front. For the control line connections required for switcher cascading, refer to section [1.4.8 Switcher Cascading](#), on page 30.

## 1.4.2 Control of the R&S UPZ

There are three possibilities of controlling a R&S UPZ:

1. Manually via an Audio Analyzer
2. Via the IEC/IEEE bus
3. Via the RS-232-C interface

The simplest way is to control the R&S UPZ via the Audio Analyzers R&S UPL, R&S UPV or R&S UPP. Their firmware contains the complete control software for the switcher so that all channel settings can be performed from the GUI.

**Control via the IEC/IEEE bus is only possible by using an Audio Analyzer.**

Depending on the device, a host PC can control the analyzer via IEC/IEEE-bus, LAN or USB device, and the Audio Analyzer controls the R&S UPZ via the RS232 or USB device. The required IEC/IEEE-bus commands are given in [Table 2-1](#).

Since the R&S UPZ has RS-232-C connectors, it can be directly controlled from a PC. See section 4 ([Remote Control via an External PC](#)) on page 58.

## 1.4.3 Connecting the Control Lines

The R&S UPZ does not provide a user interface for controlling. To control an R&S UPZ, either an Audio Analyzer (R&S UPL, R&S UPV or R&S UPP) or an external host PC is required. The connection to the controlling device is either realized by RS232 or USB.

## 1.4.4 Installing the USB Driver

How you have to install the USB driver for the R&S UPZ depends on whether the Windows XP or Windows 7 operating system is installed on the R&S UPP/UPV. The user interfaces of the two operating systems are considerably different, which is clearly recognizable when you close the R&S UPP/UPV application and click the "Start" field at the lower left with the mouse:

**Windows XP:**



**Windows 7:**

The procedure is described in one of the two following sections, depending on which operating system is installed.

Before installing the USB driver, you must connect the R&S UPZ to the audio analyzer, as described under "[1.4.7 Connection to the R&S UPP](#)" and "[1.4.6 Connection to the R&S UPV](#)".

**1.4.4.1 Installation on the R&S UPP/UPV with Windows XP Operating System**

The USB driver for the R&S UPZ is included in the R&S UPP/UPV as of firmware version 3.2.0.

When connecting the R&S UPZ to the R&S UPP/UPV for the first time, the "Found New Hardware Wizard" asks for the driver.



Select **No**, continue with **Next >**



Select **Install from a list .....**, continue with **Next >**

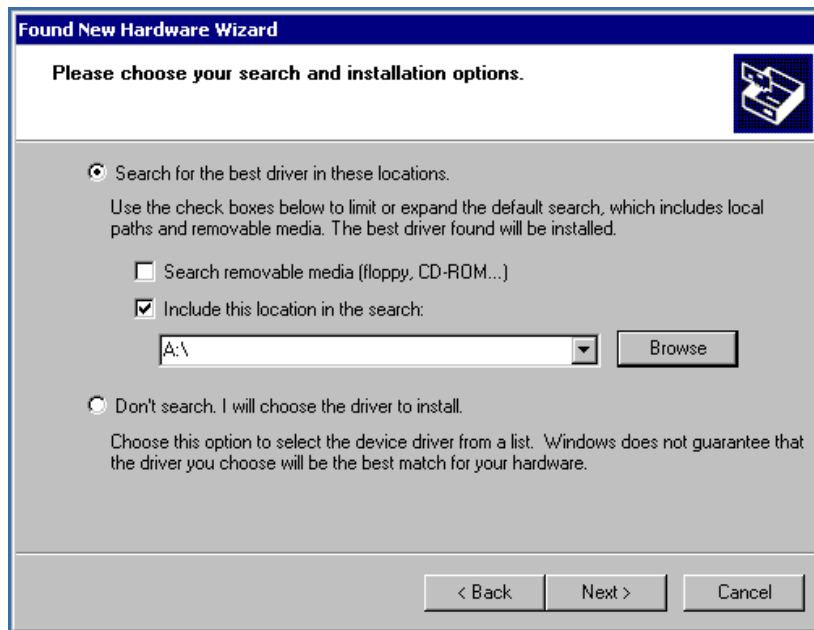

### Select **Browse**

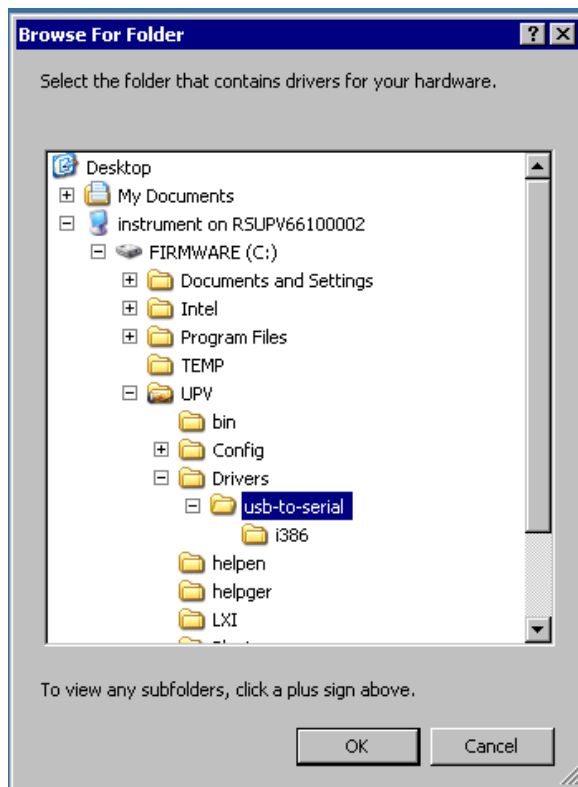

For firmware version 3.2.0 and 3.3.x select the folder **C:\UPV\Drivers\usb-to-serial**.  
For firmware version 4.0.1 or higher select the folder **C:\Program Files\Rohde-Schwarz\UPX\3.18\RS.GPAudioAdditions\usb-to-serial**.  
Continue with **OK**

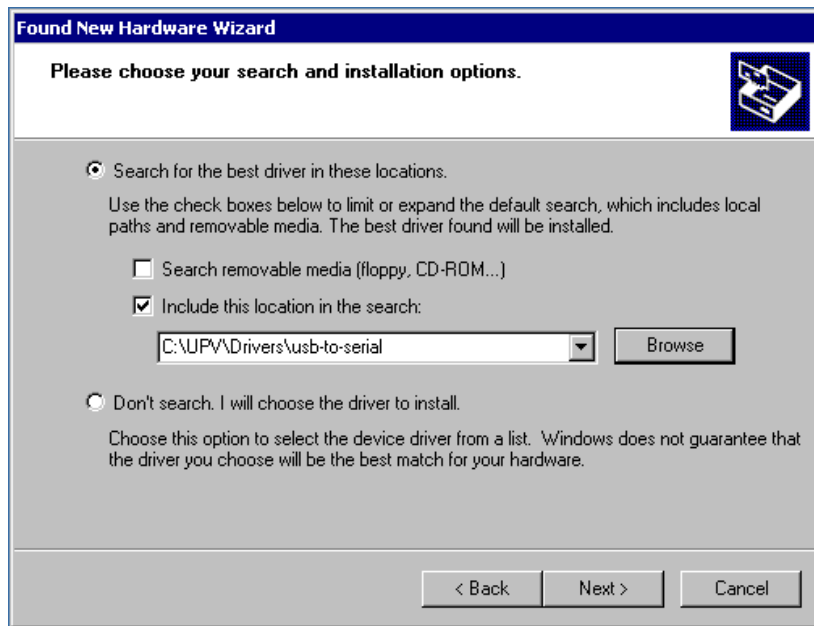

For firmware version 4.0.1 or higher the path "C:\Program Files\Rohde-Schwarz\UPX\3.18\RS.GPAudioAdditions\usb-to-serial" appears.

Continue with **Next >**

The driver is being installed.

Quit the installation with **Finish**.

The Installation Wizard returns once again. Continue as described above.

Afterwards the following message appears ...

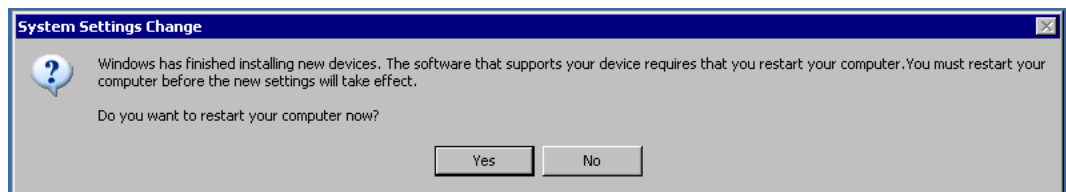

... which can be quit with **No**.

#### 1.4.4.2 Installation on the R&S UPP/UPV with Windows 7 Operating System

When an R&S UPZ is connected to the R&S UPP/UPV the first time, the "Found New Hardware Wizard" does not come automatically, as was the case with the Windows XP operating system. Rather, driver installation must be selectively initiated.

Connect the R&S UPZ to the mains, switch it on and connect it via USB cable to one of the USB ports on the R&S UPP/UPV.

Select "Start", then right-click "Computer" and left-click "Manage".

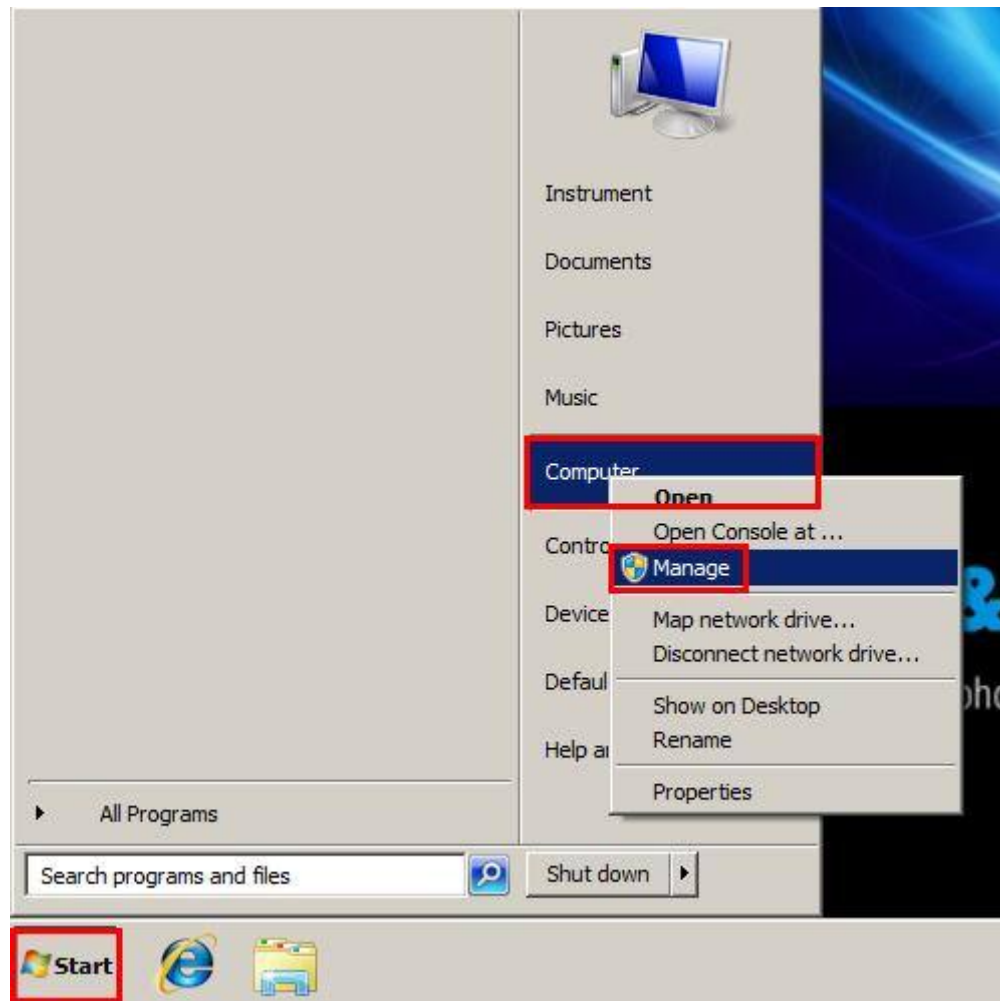

The "Computer Management" window opens.



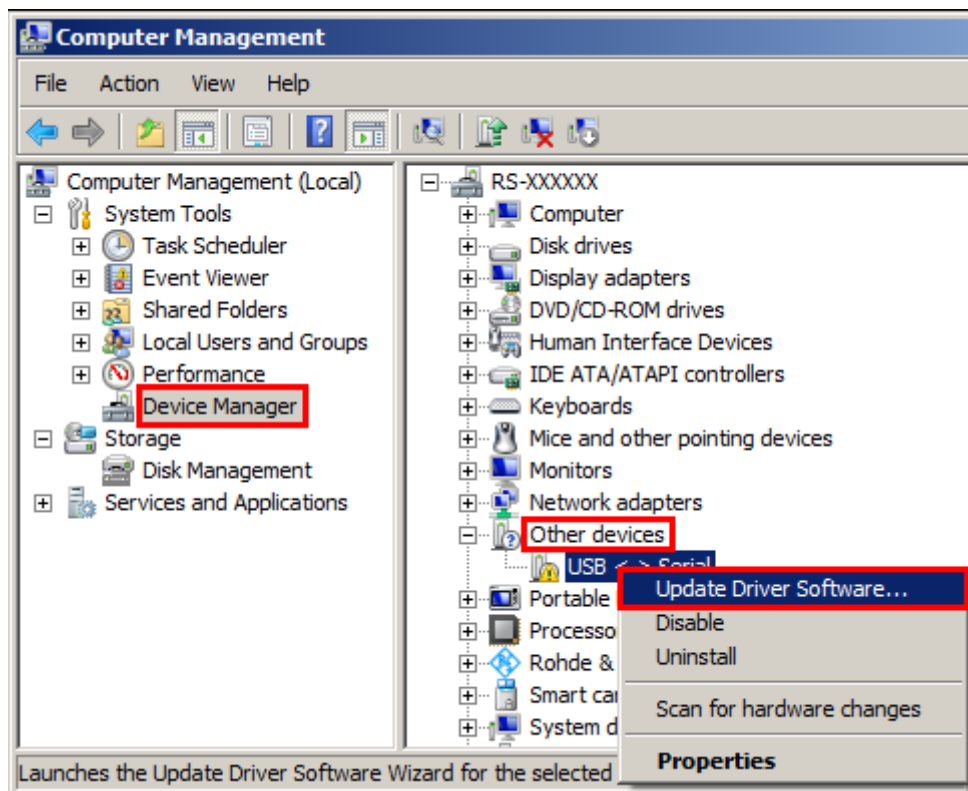

Select "Device Manager" on the left and "Other devices" on the right. The "USB <-> Serial" device appears, slightly indented, with a yellow highlighted exclamation point. This means the USB device has been detected but the driver is not yet installed. Now right-click "USB <-> Serial" and left-click "Update Driver Software ..." to start installing the driver.

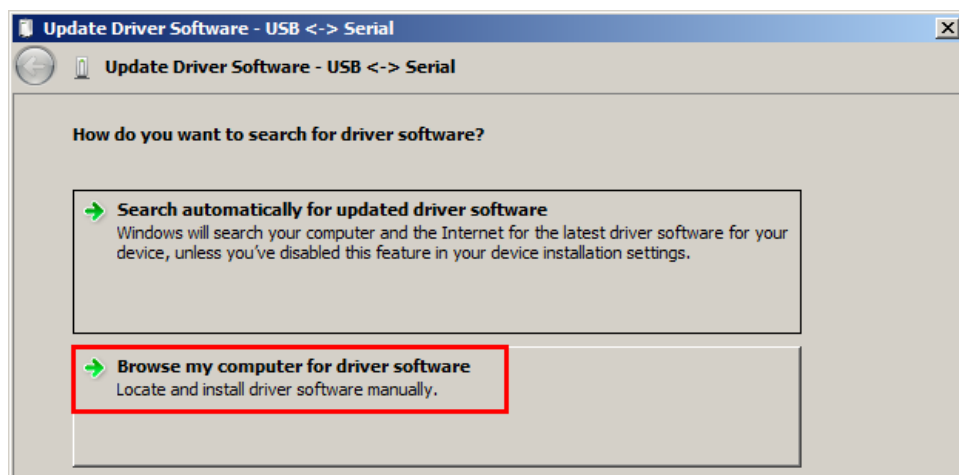

Select "Browse my computer for driver software". Another window opens.

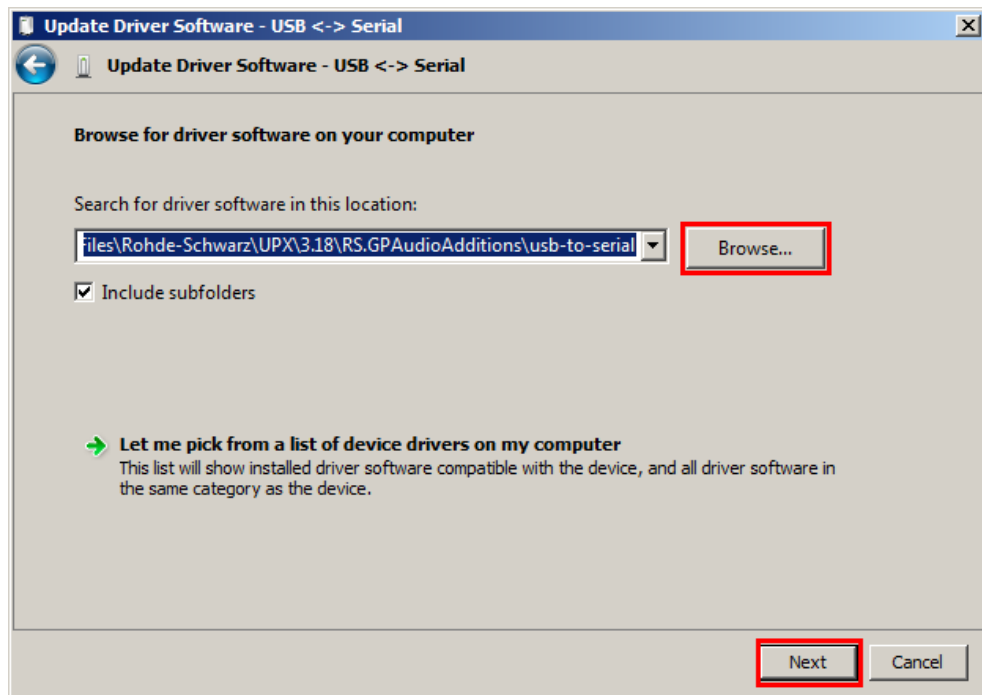

The USB driver for the R&S UPZ is on the R&S UPP/UPV hard disk under **C:\Program Files\Rohde-Schwarz\UPX\3.18\RS.GPAudioAdditions\usb-to-serial**.

The name of the directory designated "3.18" may deviate slightly.

Now use "Browse" to select this path and confirm with "OK" and then click "Next". Windows 7 does not recognize the vendor of the driver software and displays a corresponding warning.

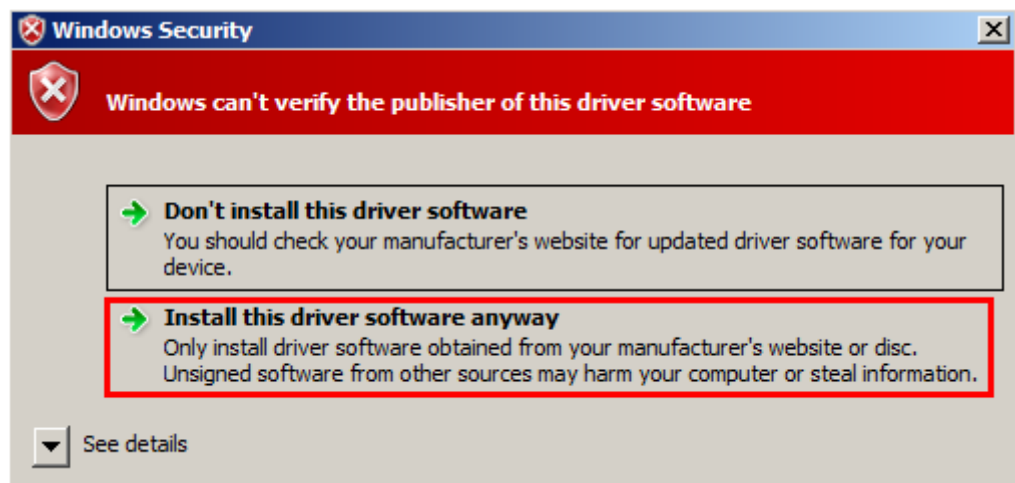

Select "Install this driver software anyway". Installation is completed with a message indicating its success.

Check whether the installation was really successful, using the exact same procedure as described above: Start, Computer, Manage, Device Manager.

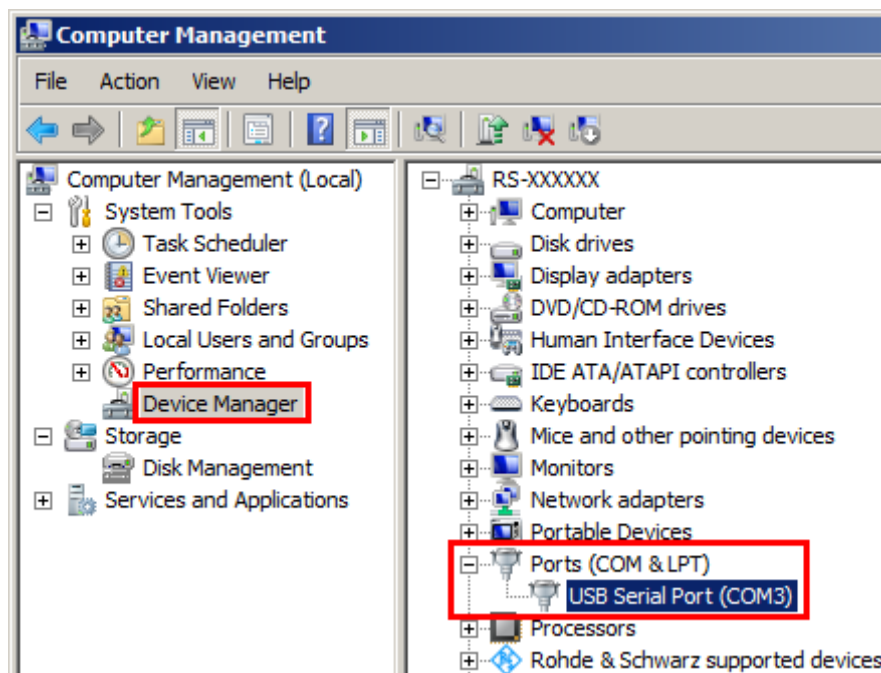

If installation was successful, the right side of the window will show "Ports (COM & LPT)" and, slightly indented, "USB Serial Port (COMx)". Which interface is displayed (COM3, 4, 5 or 6) depends on which R&S UPP/UPV USB interface the R&S UPZ is connected to).

Important note:



The first installation attempt is usually not successful. This is indicated by the exclamation point which is still highlighted yellow. But this is no reason to worry! Repeat the driver installation by right-clicking the exclamation point and left-clicking "Update Driver Software ..." as described above. Subsequently driver installation is fully completed and the R&S UPZ connected to the R&S UPP/UPV is ready to operate.

#### 1.4.4.3 Making USB Connection to the R&S UPZ

The USB connection to the R&S UPZ is made for the R&S UPP/UPV via the switcher panel:

Open the Switcher Panel and make the following settings:

Connection = USB  
COM-Port = Auto

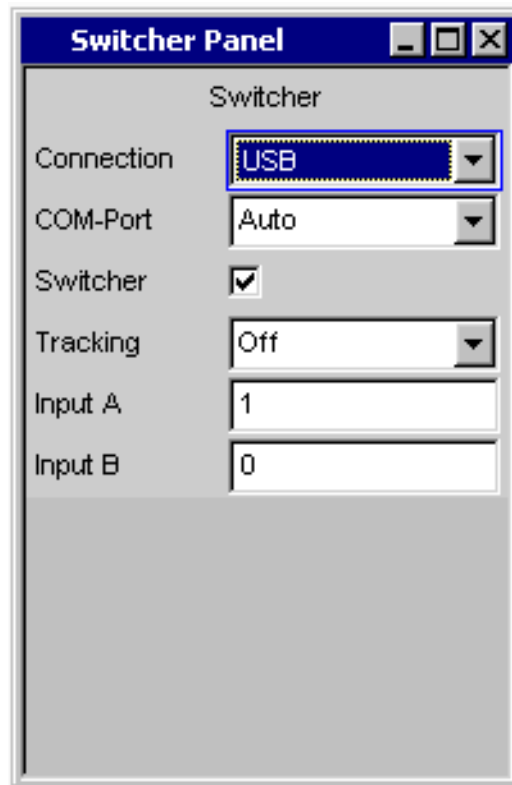

The R&S UPZ can now be operated via the Switcher Panel as usual.

### 1.4.5 Connection to the R&S UPL

The R&S UPZ is connected to the R&S UPL via a serial 9-contact RS-232-C extension cable (**no** null modem cable) using the R&S UPL's COM1 interface.

Thus, the R&S UPL can still be remote-controlled via its COM2 interface. As an alternative, the mouse can be connected to COM2 so it can be used to control the R&S UPL.

In the R&S UPZ, the extension cable is plugged into the D-sub female connector labelled "FROM PREVIOUS". When interconnecting the two instruments, ensure that the cable has a good ground contact (screw connector casing) in order to avoid EMC problems.

The data rate is 19200 baud, no parity, 8 bits and 1 stop bit, and is permanently set in the R&S UPZ. If the R&S UPZ is to be controlled via another instrument, the latter has to be adapted to the preset interface parameters of the R&S UPZ.

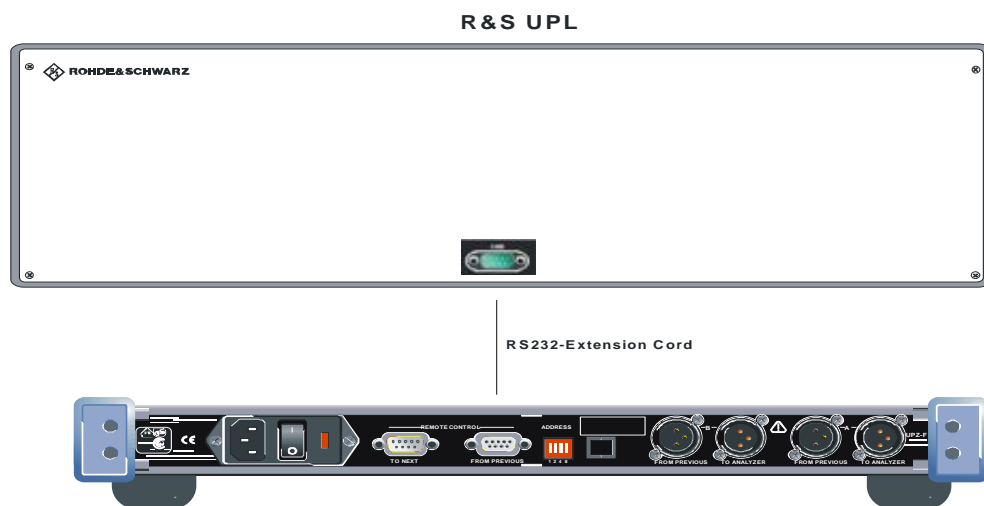

**Fig. 1-11** Connecting R&S UPL and R&S UPZ using a RS232-Extension Cord

### 1.4.6 Connection to the R&S UPV

The R&S UPZ is connected to the R&S UPL via a serial 9-contact RS-232-C extension cable (**no** null modem cable) using the R&S UPL's COM1 interface.

In the R&S UPZ, the extension cable is plugged into the D-sub female connector labelled "FROM PREVIOUS". When interconnecting the two instruments, ensure that the cable has a good ground contact (screw connector casing) in order to avoid EMC problems.

Starting from firmware version 3.2.x, the R&S UPV can also use its USB interface to control the R&S UPZ. Both devices are connected using a USB Device cable.

Only one interface can be active at a time. A coexistent connection via USB and RS232 is not possible. As soon as a USB cable is connected between the R&S UPV and the R&S UPZ, the RS232 interface labelled "FROM PREVIOUS" is disabled.

Starting from variant .12 and .13 the R&S UPZ is equipped with an USB device connection. Older models need to be controlled via RS232.

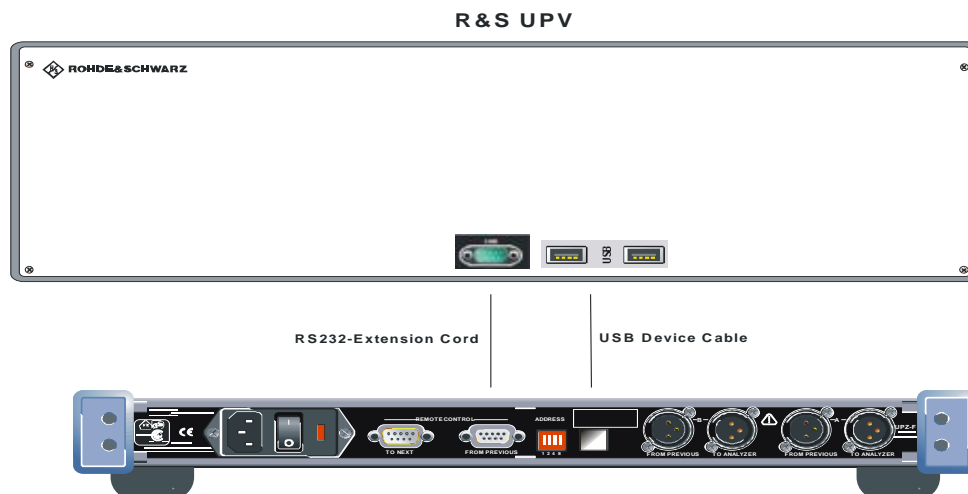

*Fig. 1-12 Connecting R&S UPV and R&S UPZ using a RS232-Extension Cord or a USB Device Cable*

### 1.4.7 Connection to the R&S UPP

In contrast to the R&S UPV and R&S UPL, the R&S UPP does not offer an RS232 interface. Therefore a USB connection is the only way of controlling an R&S UPZ from an R&S UPP. Starting from variant .12 and .13 the R&S UPZ is equipped with an USB device connection. Older models which do not offer an USB interface can be controlled by the R&S UPP by usage of a conventional USB-COM adapter cable.

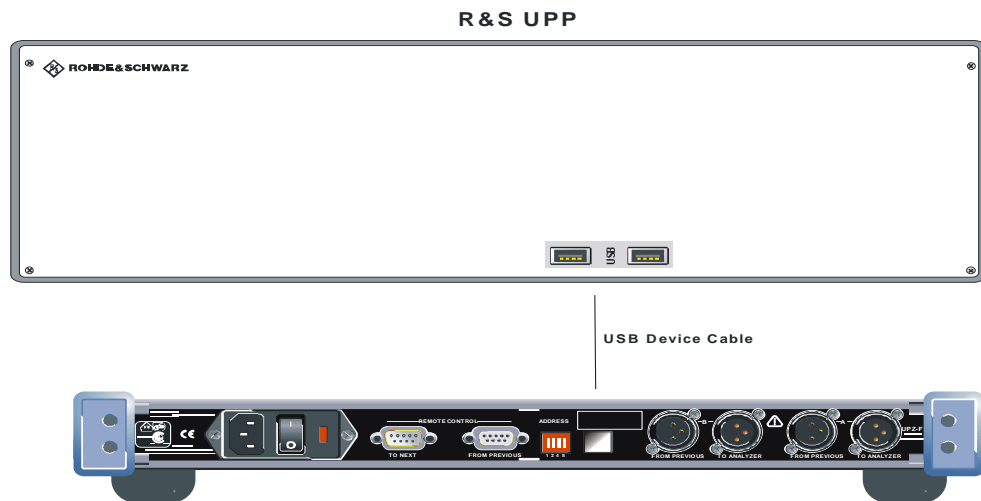

*Fig. 1-13 Connecting R&S UPP and R&S UPZ using USB Device Cable*

### 1.4.8 Switcher Cascading

In some cases, the eight channels provided by a R&S UPZ are not sufficient. Several switchers can be cascaded to extend the number of channels. With the special configuration of the RS-232-C interface of the R&S UPZ, it is possible to control up to 16 switcher addresses, although they were originally designed for only one connection between two instruments. Up to 128 channels are thus available.

The controlling connections between the different R&S UPZ are established by means of 9-contact extension cables (no null modem cables). Since the two trapezoidal connectors are internally wired in a different way, a R&S UPZ is always fitted with a socket and a plug. The connectors of the individual R&S UPZ are thus clearly defined which prevents wrong connection.

The D-sub male connector is the output for the next R&S UPZ and the D-sub female connector is the input for the preceding one. The first R&S UPZ in the series is thus connected to the Audio Analyzer via the female connector and the RS232 extension cable or an USB cable.

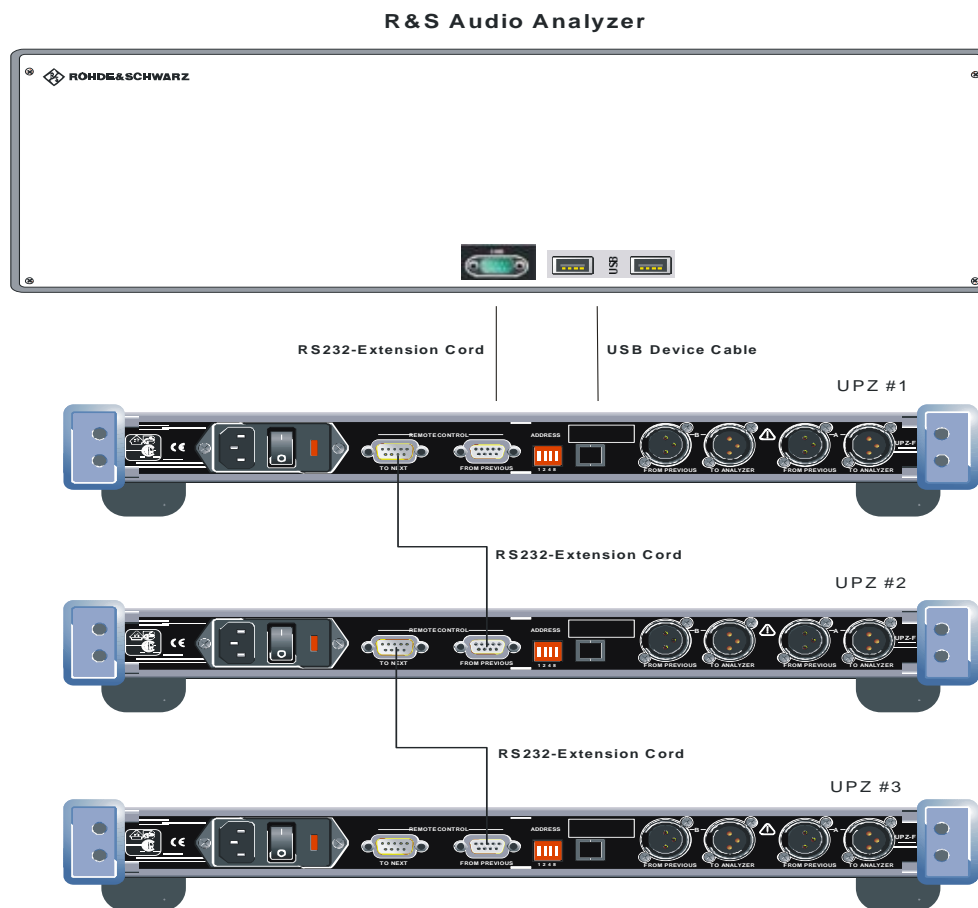

Fig. 1-14 Cascading



The setting commands are looped through by the individual R&S UPZ so that each instrument is addressed practically at the same time. Thus, the reaction time of the switchers does not depend on the number of switchers connected. While the addressed R&S UPZ executes the command and sets the desired channels, the command is ignored by all other R&S UPZ and their channels previously closed are opened.



In case of switcher cascading, ensure that all R&S UPZ connected are on. Otherwise, the R&S UPZ that is off and those following it would no longer be recognized even if they were on.

### 1.4.9 Setting the Instrument Address

On the rear panel of the R&S UPZ there is a coding switch, which is used to set the device address (from 0 to 15). Each R&S UPZ of the same type is to be assigned an own address. The setting is performed in the binary format. Fig. 1-15 shows the rear-panel cutout with the address switch. The channel range is linked to a set address. This is shown in Table 1-2. A special feature that is not mentioned in the table refers to channel No. 0. Channel 0 can be set. In this case, all channels of all switchers connected are opened. This is the default state.



All switchers of the R&S UPZ family are factory-set to address 0. If several switchers are to be cascaded in a test setup, it is necessary to set the R&S UPZ of the same type to different addresses in order to ensure correct operation.

It is recommended to select the R&S UPZ addresses in ascending order without a gap in order to keep a convenient overview of the settable channel ranges of cascaded switchers.

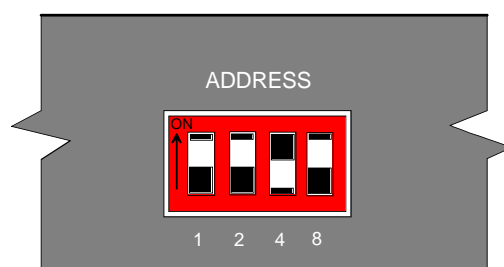

Fig. 1-15 R&S UPZ addressing

Table 1-2 Relationship device address ↔ channel number

Address	Setting				Channel range	Binary code
	1	2	4	8		
0	OFF	OFF	OFF	OFF	1 to 8	0000
1	ON	OFF	OFF	OFF	9 to 16	0001
2	OFF	ON	OFF	OFF	17 to 24	0010
3	ON	ON	OFF	OFF	25 to 32	0011
4	OFF	OFF	ON	OFF	33 to 40	0100
5	ON	OFF	ON	OFF	41 to 48	0101
6	OFF	ON	ON	OFF	49 to 56	0110
7	ON	ON	ON	OFF	57 to 64	0111
8	OFF	OFF	OFF	ON	65 to 72	1000
9	ON	OFF	OFF	ON	73 to 80	1001
10	OFF	ON	OFF	ON	81 to 88	1010
11	ON	ON	OFF	ON	89 to 96	1011
12	OFF	OFF	ON	ON	97 to 104	1100
13	ON	OFF	ON	ON	105 to 112	1101
14	OFF	ON	ON	ON	113 to 120	1110
15	ON	ON	ON	ON	121 to 128	1111

Although only 16 addresses are available, it is possible to connect 32 R&S UPZ. This is due to the fact that an input **and** an output switcher can be connected to each address. The controlling Audio Analyzer recognizes the different types of switcher and selects the desired one.

## 2 Manual Operation

Manual operation of the R&S UPZ is performed by using the firmware of the controlling Audio Analyzer.

### 2.1 Control elements

The R&S UPZ has no manual control elements, except the rear-panel ON/OFF switch. The signal inputs and outputs, the ON LED and the channel LEDs are located on the front panel.

The R&S UPZ can easily be controlled via an Audio Analyzer. Another possibility is operating the R&S UPZ from a commercial PC via the RS-232-C interface provided a common transfer program is available (e.g. "Tera Term Pro" from T. Teranishi or "HyperTerminal" from Hilgraeve Inc.).

### 2.2 Display Elements

The R&S UPZ is equipped with several front-panel LEDs. They have the following functions:

#### ON

This LED lights up immediately after power-up and indicates that it is ready for operation.

#### Channel LEDs

Each input or output channel from 1 to 8 is fitted with two LEDs, i.e. a green one and an yellow one. They correspond to the single green LED of the busbar labelled **A** and to the single yellow LED of the busbar labelled **B**.

If, for example, the green LED of channel 5 lights up (and the green LED in **A**), channel 5 is connected to busbar **A**. Similarly, the connection to busbar **B** is indicated by the yellow LED lighting up for channel 8.

If no channel is selected in a R&S UPZ (e.g. by channel No. 0 or a channel that is outside of the specified channel range), the busbar LED **A** or **B** goes out.

## 2.3 Link Establishment using an R&S UPL

The following describes the link establishment between the controlling R&S UPL and the R&S UPZ.

Select **OPTIONS** on the R&S UPL and move the cursor downwards until the **SWITCHER Switcher OFF** line is displayed. Pressing the **SELECT** key on the R&S UPL or the space bar on a connected keyboard opens the following window.

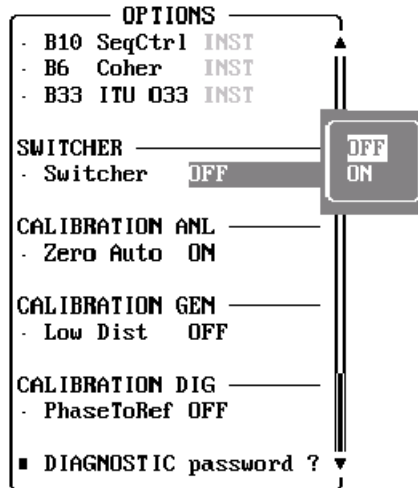

Fig. 2-1 Option Panel: R&S UPL

- ▶ Select "ON" to enable operation of the R&S UPZ:

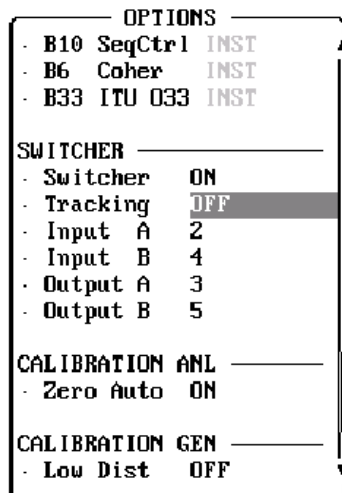

Fig. 2-2 Switcher Panel: R&S UPL

The window shown here provides all control possibilities. This requires that at least one input and one output switcher are connected. Otherwise, only the lines relating to the connected switcher are displayed (the corresponding lines of an output switcher are not displayed if none is connected, for example).

After opening the switcher user interface, the link between all switchers connected is established. This operation is performed as follows:

First of all, the R&S UPL searches all addresses from 0 to 15 for a R&S UPZ connected.

Each address is queried twice, first for a connected input switcher, then for a connected output switcher.

A R&S UPZ connected outputs a response string, which displays the firmware and hardware status.

After the addresses have been queried, the R&S UPL has all the information on the R&S UPZ connected and stores them in tabular form in a file in the directory `C:\UPL\USER`. The information can then be read out at the DOS level using `TYPE UPZCONF.TXT`.

Since the response of the R&S UPZ is relatively short, the address query is executed very quickly. This query is the only operation in which a R&S UPZ responds. If the R&S UPL sends a channel setting command, the desired setting is performed in the switcher addressed by the channel number whereas all other R&S UPZ open their relays. The R&S UPZ, however, return no acknowledgement. As a result, the reaction to a setting command is always performed at the same speed regardless of whether only one or up to 32 switchers are connected.



The R&S UPL cannot recognize if two or more switchers are set inadvertently to the same address. It "sees" only **one** R&S UPZ at the address concerned because the switchers respond to the query practically at the same time. This means that two or more switchers set **the same** channel. With input switchers, this may cause problems with the generators connected.

---

## 2.4 R&S UPL Default Setting

If the switcher panel is activated for the first time after loading the R&S UPL default setup, the channels are set to a defined default state. All channels of the two switcher types are set to 0 in this state. If tracking is additionally activated for the first time, tracking **B vs A** is set to "-1" and tracking **Out vs Inp** to "0". Thus it can be ensured that channels are not unpredictably closed when the user interface is opened, which would cause illegal states in the test setup. Fig. 2-3 shows this switcher setting.

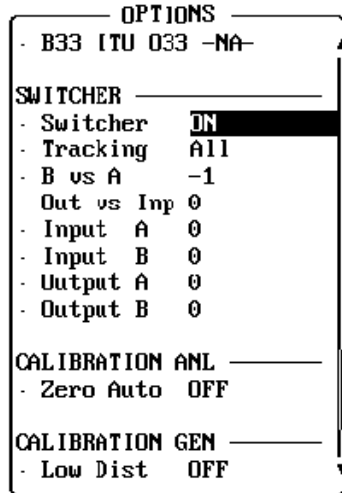

Fig. 2-3 Default-Setting: R&S UPL

If the same setting as in the default state is to be obtained, it is sufficient to set any channel to "0" with the tracking setting described above. All other settings are then adapted.

## 2.5 Operating the R&S UPZ from the R&S UPL

Fig. 2-4 shows the operating panel displayed on the R&S UPL screen when an input switcher and an output switcher are connected (otherwise, only the lines relating to the recognized switcher type would appear).

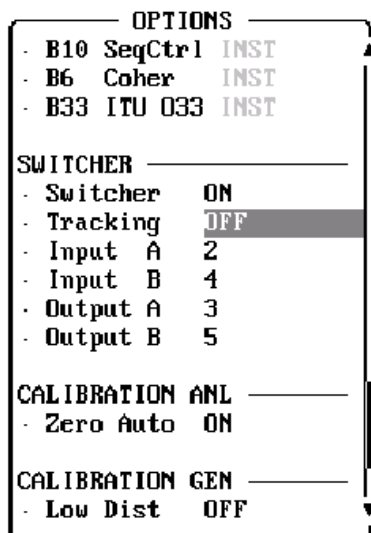

Fig. 2-4 Channel setting via the R&S UPL

Two lines are available for each switcher type, i.e. one for busbar A, the other for busbar B. If any line is selected (by setting the black bar to the desired line), numerical entry of the channel can be performed by pressing the SELECT key and confirming the selection with ENTER. If ENTER is pressed instead of the SELECT key, the channel can be selected by simply actuating the rollkey on the front panel of the R&S UPL. The channel number set by means of the rollkey is immediately active so that the channels can be through-connected by just turning the rollkey. Pressing a cursor key or ENTER terminates this entry mode.

It is not possible to set the same channel to busbar A and B. If an attempt is made to do this, the R&S UPL skips the set channel.

### Example: (see Fig. 2-4)

Busbar B of the input switcher (address 0) is connected to input 4 and busbar A to 2. If 4 is entered for busbar A, the direction is from bottom to top (towards higher numbers). The R&S UPL thus changes the entry to 5. If busbar A is to be connected to input 4, busbar B should be previously set to another channel.

If busbar A had previously been on No. 6, the R&S UPL would have changed the entry to 3. This means that the activated channel of the other busbar is always skipped by 1.

This skip function is also available when the instrument is operated by means of the rollkey.

If a suitable setup is available, channel numbers from 0 to 128 are permissible. Either all 15 switcher addresses are occupied or the suitable R&S UPZ address has to be set at the coding switch for entering higher channel numbers.

Channel number 0 means that all channels of all the switchers connected are opened.

The output switcher has a special feature as regards busbar B: It is possible to enter – 1 as channel number. In this case, **all** channels of **all** switchers connected are closed in busbar B, except the channel selected in busbar A. This setting is useful for worst-case crosstalk measurements. If no channel is selected in busbar A (number 0), all channels are closed in busbar B. This setting can be used to supply all DUTs connected with signals for burn-in tests.

If the user enters a channel number, which corresponds to a R&S UPZ at a non-assigned address, the R&S UPL generates an error message, for example:



Fig. 2-5 Error Message: R&S UPL

This error message can be acknowledged by pressing the ENTER key or turning the rollkey by one step. Although the switcher is not connected, the R&S UPL sends the entered channel command and updates the display. As regards the R&S UPZ connected, this causes the previously set channel to be opened.

As shown in Fig. 2-6, the different channels can be changed together. This is called tracking. The user can thus select a channel offset between the two busbars or input and output switcher. If a line is operated, the other one/ones are automatically adapted by the R&S UPL (due to the channel offset). There are three possibilities (see Fig. 2-6):

- Tracking only between busbars A and B (tracking between A and B equally applies to input and output switchers connected)  
Application: measurements on multichannel DUTs
- Tracking between input and output switcher  
Application: crosstalk measurements in the adjacent channel
- Combination of the two tracking modes

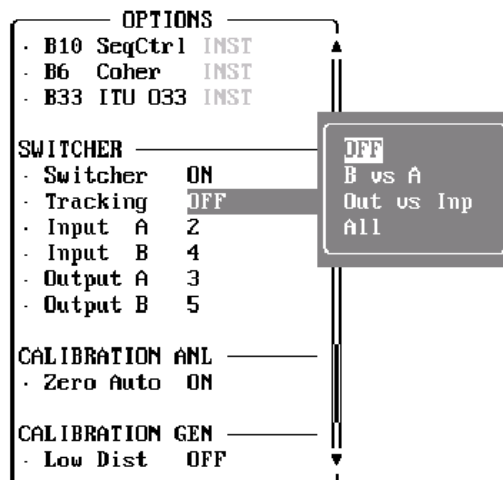

Fig. 2-6 Tracking selection: R&S UPL



In Fig. 2-7 the user has selected **Tracking All**. The R&S UPZ control is extended by lines **B vs A** and **Out vs Inp** :

```

  OPTIONS
  - B33 ITU 033 -Ma-
  SWITCHER
  - Switcher  DN
  - Tracking  All
  - B vs A    2
  - Out vs Inp 1
  - Input A   1
  - Input B   3
  - Output A  2
  - Output B  4
  CALIBRATION ANL
  - Zero Auto OFF
  CALIBRATION GEN
  - Low Dist  OFF
  
```

*Fig. 2-7 Complete tracking feature: R&S UPL*

This user interface of the R&S UPZ displays all settings, which can be performed from the R&S UPL. The user can select any line. The other channels are automatically updated by the R&S UPL.

[Table 2-1](#) indicates all possible settings in the R&S UPL control panel. The associated remote control commands are listed.

Further information on the syntax of the R&S UPL remote control commands is given in the R&S UPL operating manual.

Table 2-1 List of settings and IEC/IEEE-bus commands: R&S UPL

Setting	Effect	IEC/IEEE-bus command
Switcher OFF → ON	R&S UPZ control is switched on	<b>SWITcher:STATe ON OFF</b>
Input A n	Channel n of input switcher is switched to busbar A	<b>SWITcher:INPA &lt;n&gt;</b>
Input B n	Channel n of input switcher is switched to busbar B	<b>SWITcher:INPB &lt;n&gt;</b>
Output A n	Channel n of output switcher is switched to busbar A	<b>SWITcher:OUTA &lt;n&gt;</b>
Output B n	Channel n of output switcher is switched to busbar B	<b>SWITcher:OUTB &lt;n&gt;</b>
Tracking OFF B vs A OUT vs INP ALL	An additional selection window is opened for channel tracking. without tracking only busbar B versus A only output versus input both tracking modes simultaneously	<b>SWITcher:TRACking OFF</b> <b>SWITcher:TRACking BVSA</b> <b>SWITcher:TRACking OVSI</b> <b>SWITcher:TRACking ALL</b>
B vs A n	The channel on busbar B is offset by <n> versus A	<b>SWITcher:OFFSet:BVSA &lt;n&gt;</b>
Out vs Inp n	The channel of the output switcher is offset by <n> versus the input switcher	<b>SWITcher:OFFSet:OVSI &lt;n&gt;</b>

## 2.6 Link Establishment using an R&S UPV

The following steps illustrate how to establish a connection between an R&S UPZ and an R&S UPV.

If the R&S UPZ needs to be controlled via RS232, open the Config Panel from the menu bar:

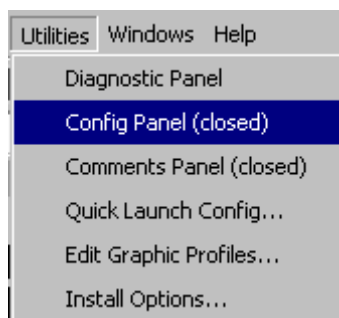
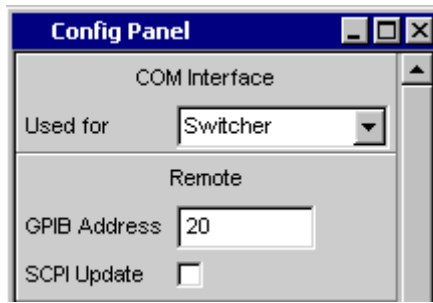

Fig. 2-8 Config Panel: R&S UPV

The selection "Used for" needs to be set to "Switcher". If the COM interface was used for remote control previously, the R&S UPV must be rebooted after the change.



**Fig. 2-9 COM Interface: R&S UPV**

These steps are not necessary when the USB interface is used for controlling the R&S UPZ.

Open the Switcher Panel using the menu bar:

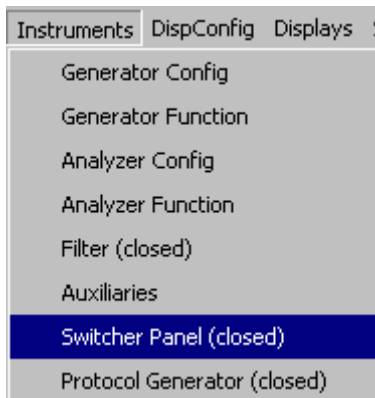

**Fig. 2-10 Opening the Switcher Panel: R&S UPV**

Depending on whether RS232 or USB should be used for controlling the R&S UPZ, the according interface should be selected:

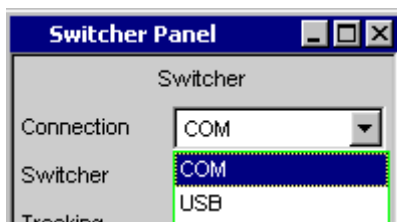

**Fig. 2-11 Choosing the Interface: R&S UPV**

## 2.7 Link Establishment using an R&S UPV and USB

If the USB interface was selected, the used COM Port must be selected next. The COM Port used by the driver can, as shown in the following figure, be determined using the Device Manager (example here: COM4 port).

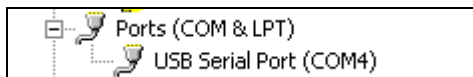

Fig. 2-12 USB Serial Port: R&S UPV

The easiest way of establishing a connection however is using the „Auto“ setting. In this mode, the R&S UPV scans all available COM Ports for an R&S UPZ and waits for their response.

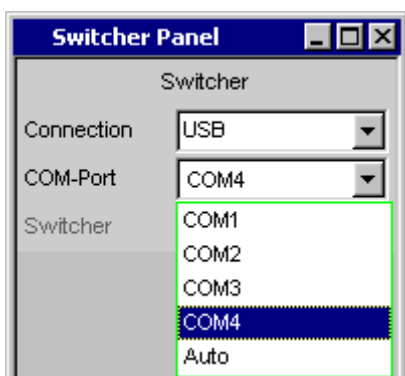

Fig. 2-13 COM Port Scan: R&S UPV

Possible selection: RS232 or USB

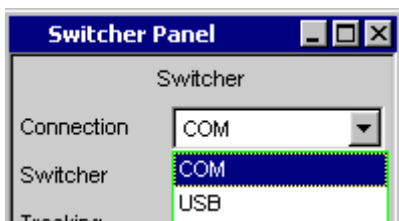

Fig. 2-14 Interface selection: R&S UPV

## 2.8 Link Establishment using an R&S UPV and RS232

When using a RS232 connection, this choice is not offered. COM1 will be used always. In both cases, a connection is established by selecting the Switcher checkbox.



**Fig. 2-15 Switcher Connection Establishment: R&S UPV**

After a successful connection the following choices are offered:

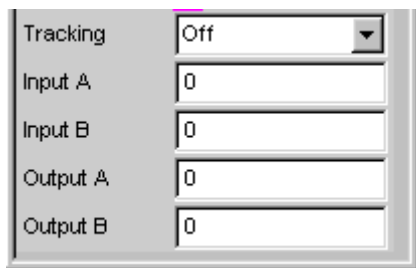

**Fig. 2-16 Switcher Panel: R&S UPV**

The window shown here provides all control possibilities. This requires that at least one input and one output switcher are connected. Otherwise, only the lines relating to the connected switcher are displayed (the corresponding lines of an output switcher are not displayed if none is connected, for example).

After opening the switcher user interface, the link between all switchers connected is established. This operation is performed as follows:

First of all, the R&S UPV searches all addresses from 0 to 15 for a R&S UPZ connected. Each address is queried twice, first for a connected input switcher, then for a connected output switcher.

Since the response of the R&S UPZ is relatively short, the address query is executed very quickly. This query is the only operation in which a R&S UPZ responds. If the R&S UPV sends a channel setting command, the desired setting is performed in the switcher addressed by the channel number whereas all other R&S UPZ open their relays. The R&S UPZ, however, return no acknowledgement. As a result, the reaction to a setting command is always performed at the same speed regardless of whether only one or up to 32 switchers are connected.



The R&S UPV cannot recognize if two or more switchers are set inadvertently to the same address. It "sees" only one R&S UPZ at the address concerned because the switchers respond to the query practically at the same time. This means that two or more switchers set the same channel. With input switchers, this may cause problems with the generators connected.

## 2.9 R&S UPV Default Setting

If the switcher panel is activated for the first time after loading the R&S UPL default setup, the channels are set to a defined default state. All channels of the two switcher types are set to 0 in this state. Thus it can be ensured that channels are not unpredictably closed when the user interface is opened, which would cause illegal states in the test setup.

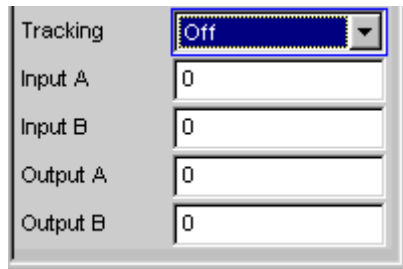
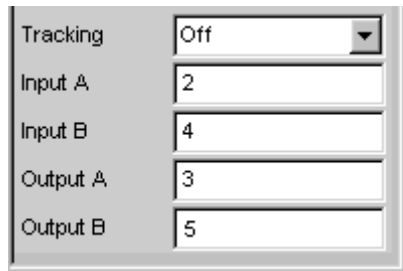

*Fig. 2-17 Default-Setting: R&S UPV*

If the same setting as in the default state is to be obtained, it is sufficient to set any channel to "0" with the tracking setting described above. All other settings are then adapted.

## 2.10 Operating the R&S UPZ from the R&S UPV

The figure shows the operating panel displayed when an input switcher and an output switcher are connected (otherwise, only the lines relating to the recognized switcher type would appear).



*Fig. 2-18 Channel setting via the R&S UPV*

Two lines are available for each switcher type, i.e. one for busbar A, the other for busbar B. If any line is selected (by setting the black bar to the desired line), numerical entry of the channel can be performed by pressing the SELECT key and confirming the selection with ENTER. If ENTER is pressed instead of the SELECT key, the channel can be selected by simply actuating the rollkey on the front panel. The channel number set by means of the rollkey is immediately active so that the channels can be through-connected by just turning the rollkey. Pressing a cursor key or ENTER terminates this entry mode.

It is **not** possible to set the same channel to busbar A **and** B. The R&S UPV skips the set channel.

**Example:**

Busbar B of the input switcher (address 0) is connected to input **4** and busbar A to **2**. If **4** is entered for busbar A, the direction is from bottom to top (towards higher numbers). The R&S UPV thus changes the entry to **5**. If busbar A is to be connected to input **4**, B should be previously set to another channel.

If busbar A had previously been on No. **6**, the R&S UPV would have changed the entry to **3**. This means that the activated channel of the other busbar is always skipped by **1**.

This skip function is also available when the instrument is operated by means of the rollkey.

If a suitable setup is available, channel numbers from 0 to 128 are permissible. Either all 15 switcher addresses are occupied or the suitable R&S UPZ address has to be set at the coding switch for entering higher channel numbers.

Channel number 0 means that all channels of all the switchers connected are opened.

The output switcher has a special feature as regards busbar B: It is possible to enter **-1** as channel number. In this case, **all** channels of **all** switchers connected are closed in busbar B, except the channel selected in busbar A. This setting is useful for worst-case crosstalk measurements. If no channel is selected in busbar A (number 0), all channels are closed in busbar B. This setting can be used to supply all DUTs connected with signals for burn-in tests.

If the user enters a channel number, which corresponds to a R&S UPZ at a non-assigned address, the R&S UPV generates an error message, for example:

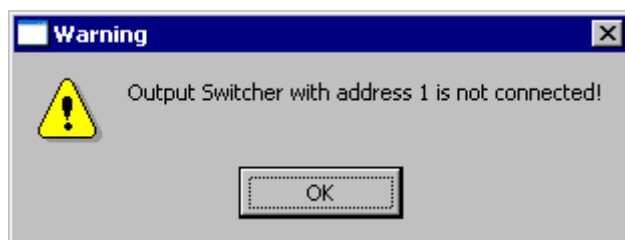

**Fig. 2-19 Error Message: R&S UPV**

This error message can be acknowledged by pressing the ENTER key or turning the rollkey by one step. Although the switcher is not connected, the R&S UPV sends the entered channel command and updates the display. As regards the R&S UPZ connected, this causes the previously set channel to be opened.

As shown in next figure, the different channels can be changed together. This is called tracking. The user can thus select a channel offset between the two busbars or input and output switcher. If a line is operated, the other one/ones are automatically adapted by the R&S UPV (due to the channel offset). There are three possibilities:

- Tracking only between busbars **A** and **B** (tracking between **A** and **B** equally applies to input and output switchers connected)  
**Application:** measurements on multichannel DUTs
- Tracking between input and output switcher  
**Application:** crosstalk measurements in the adjacent channel
- Combination of the two tracking modes

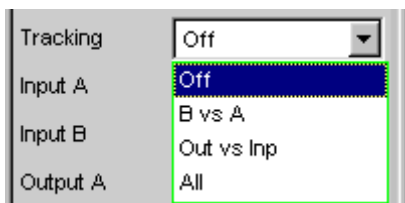

Fig. 2-20 Tracking selection: R&S UPV

Table 2-2 indicates all possible settings in the R&S UPV control panel. The associated remote control commands are listed. Further information on the syntax of the R&S UPV remote control commands is given in the R&S UPV operating manual.

Table 2-2 List of settings and IEC/IEEE-bus commands: R&S UPV

Setting	Effect	IEC/IEEE-bus command
Switcher COM Port	Selection of the virtual COM Port on which the R&S UPZ USB connection is installed.	<b>SWITcher:COMPort COM&lt;n&gt;</b> <b>SWITcher:COMPort AUTO</b>
Switcher OFF → ON	R&S UPZ control is switched on	<b>SWITcher:STATe ON OFF</b>
Input A n	Channel n of input switcher is switched to busbar A	<b>SWITcher:INPA &lt;n&gt;</b>
Input B n	Channel n of input switcher is switched to busbar B	<b>SWITcher:INPB &lt;n&gt;</b>
Output A n	Channel n of output switcher is switched to busbar A	<b>SWITcher:OUTA &lt;n&gt;</b>
Output B n	Channel n of output switcher is switched to busbar B	<b>SWITcher:OUTB &lt;n&gt;</b>
Tracking OFF B vs A OUT vs INP ALL	An additional selection window is opened for channel tracking. without tracking only busbar B versus A only output versus input both tracking modes simultaneously	<b>SWITcher:TRACking OFF</b> <b>SWITcher:TRACking BVSA</b> <b>SWITcher:TRACking OVSI</b> <b>SWITcher:TRACking ALL</b>
B vs A n	The channel on busbar B is offset by <n> versus A	<b>SWITcher:OFFSet:BVSA &lt;n&gt;</b>
Out vs Inp n	The channel of the output switcher is offset by <n> versus the input switcher	<b>SWITcher:OFFSet:OVSI &lt;n&gt;</b>



## 2.11 Link Establishment using an R&S UPP

The following steps illustrate how to establish a connection between an R&S UPZ and an R&S UPV.

Because the R&S UPP offers no RS232 interface the R&S UPZ has to be controlled via USB. From variant .12 (Input Switcher) and .13 (Output Switcher) each R&S UPZ is equipped with a USB interface.

The older variants .02/.03 which don't offer an USB interface can be controlled by the R&S UPP by usage of a conventional USB-COM adapter cable.

During the installation of the R&S UPV firmware, a driver for controlling the R&S UPZ via USB is installed automatically. The USB interface is listed as "USB Serial Port" in the Device Manager and maps the USB chip inside the R&S UPZ to a virtual COM Port.

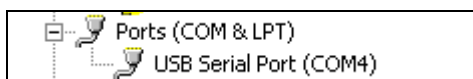

**Fig. 2-21 USB Serial Port: R&S UPP**

The Switcher Panel is opened by using the menu bar:

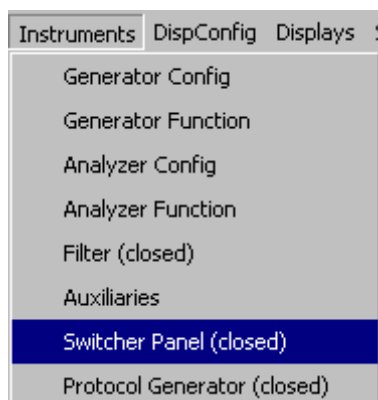

**Fig. 2-22 Opening the Switcher Panel: R&S UPP**

The used COM Port must be selected next. Like shown in [Table 2-2](#), the COM Port used by the driver can be figured out using the Device Manager.

The easiest way of establishing a connection however is using the „Auto“ setting. In this mode, the R&S UPP scans all available COM Ports for an R&S UPZ and waits for their response.

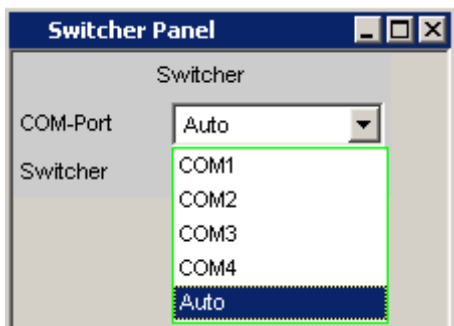

Fig. 2-23 COM Port Scan: R&S UPP

A connection is established by selecting the Switcher checkbox.



Fig. 2-24 Switcher Connection Establishment: R&S UPP

After a successful connection the following choices are offered:

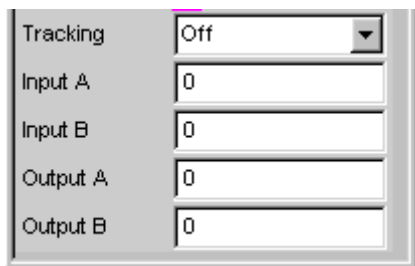

Fig. 2-25 Switcher Panel: R&S UPP

The window shown here provides all control possibilities. This requires that at least one input and one output switcher are connected. Otherwise, only the lines relating to the connected switcher are displayed (the corresponding lines of an output switcher are not displayed if none is connected, for example).

After opening the switcher user interface, the link between all switchers connected is established. This operation is performed as follows:

First of all, the R&S UPV searches all addresses from 0 to 15 for a R&S UPZ connected. Each address is queried twice, first for a connected input switcher, then for a connected output switcher.

Since the response of the R&S UPZ is relatively short, the address query is executed very quickly. This query is the only operation in which a R&S UPZ responds. If the R&S UPP sends a channel setting command, the desired setting is performed in the switcher addressed by the channel number whereas all other R&S UPZ open their relays. The R&S UPZ, however, return no acknowledgement. As a result, the reaction to a setting command is always performed at the same speed regardless of whether only one or up to 32 switchers are connected.



The R&S UPP cannot recognize if two or more switchers are set inadvertently to the same address. It "sees" only **one** R&S UPZ at the address concerned because the switchers respond to the query practically at the same time. This means that two or more switchers set **the same** channel. With input switchers, this may cause problems with the generators connected.

## 2.12 R&S UPP Default Setting

If the switcher panel is activated for the first time after loading the R&S UPP default setup, the channels are set to a defined default state. All channels of the two switcher types are set to 0 in this state. Thus it can be ensured that channels are not unpredictably closed when the user interface is opened, which would cause illegal states in the test setup.

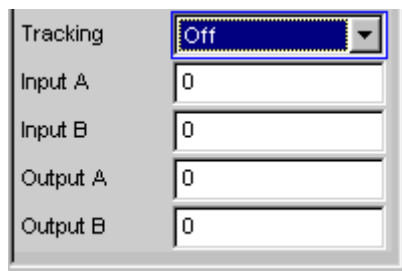
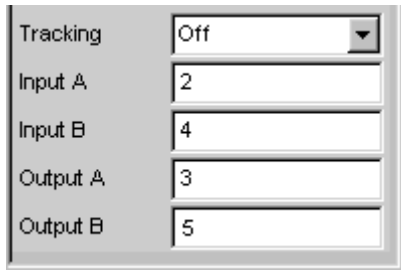

*Fig. 2-26 Default-Setting: R&S UPP*

If the same setting as in the default state is to be obtained, it is sufficient to set any channel to "0" with the tracking setting described above. All other settings are then adapted.

## 2.13 Operating the R&S UPZ from the R&S UPP

The following screenshot shows the panel displayed when an input switcher and an output switcher are connected (otherwise, only the lines relating to the recognized switcher type would appear).



*Fig. 2-27 Channel setting via the R&S UPP*

Two lines are available for each switcher type, i.e. one for busbar A, the other for busbar B. If any line is selected (by setting the black bar to the desired line), numerical entry of the channel can be performed by pressing the SELECT key and confirming the selection with ENTER. If ENTER is pressed instead of the SELECT key, the channel can be selected by simply actuating the rollkey on the front panel. The channel number set by means of the rollkey is immediately active so that the channels can be through-connected by just turning the rollkey. Pressing a cursor key or ENTER terminates this entry mode.

It is **not** possible to set the same channel to busbar A **and** B. The R&S UPP skips the set channel.

### Example:

Busbar B of the input switcher (address 0) is connected to input **4** and busbar A to **2**. If **4** is entered for busbar A, the direction is from bottom to top (towards higher numbers). The R&S UPP thus changes the entry to **5**. If busbar A is to be connected to input **4**, B should be previously set to another channel.

If busbar A had previously been on No. **6**, the R&S UPP would have changed the entry to **3**. This means that the activated channel of the other busbar is always skipped by **1**.

If a suitable setup is available, channel numbers from 0 to 128 are permissible. Either all 15 switcher addresses are occupied or the suitable R&S UPZ address has to be set at the coding switch for entering higher channel numbers.

Channel number 0 means that all channels of all the switchers connected are opened.

The output switcher has a special feature as regards busbar B: It is possible to enter **-1** as channel number. In this case, **all** channels of **all** switchers connected are closed in busbar B, except the channel selected in busbar A. This setting is useful for worst-case crosstalk measurements. If no channel is selected in busbar A (number 0), all channels are closed in busbar B. This setting can be used to supply all DUTs connected with signals for burn-in tests.

If the user enters a channel number, which corresponds to a R&S UPZ at a non-assigned address, the R&S UPP generates an error message, for example:

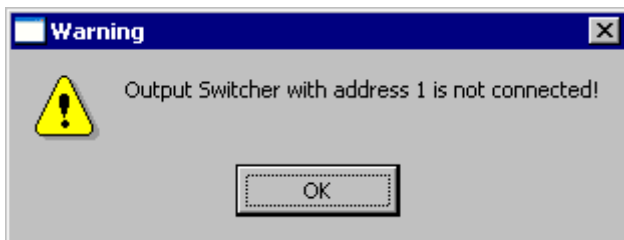

Fig. 2-28 Error Message: R&S UPP

This error message can be acknowledged. Although the switcher is not connected, the R&S UPP sends the entered channel command and updates the display. As regards the R&S UPZ connected, this causes the previously set channel to be opened.

The different channels can be changed together. This is called tracking. The user can thus select a channel offset between the two busbars or input and output switcher. If a line is operated, the other one/ones are automatically adapted by the R&S UPV (due to the channel offset). There are three possibilities:

- Tracking only between busbars A and B (tracking between A and B equally applies to input and output switchers connected)

**Application:** measurements on multichannel DUTs

- Tracking between input and output switcher

Application: crosstalk **measurements in the adjacent channel**

- Combination of the two tracking modes

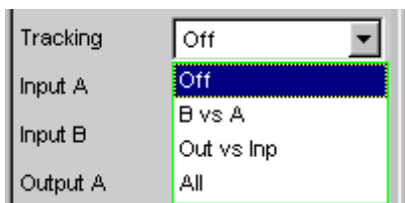

Fig. 2-29 Tracking selection: R&S UPP

The following table indicates all possible settings in the R&S UPP control panel. The associated remote control commands are listed. Further information on the syntax of the R&S UPV remote control commands is given in the R&S UPP operating manual.

**Table 2-3 List of settings and IEC/IEEE-bus commands: R&S UPP**

Setting	Effect	IEC/IEEE-bus command
Switcher COM Port	Selection of the virtual COM Port on which the R&S UPZ USB connection is installed.	<b>SWITcher:COMPort COM&lt;n&gt;</b> <b>SWITcher:COMPort AUTO</b>
Switcher OFF → ON	R&S UPZ control is switched on	<b>SWITcher:STATe ON OFF</b>
Input A n	Channel n of input switcher is switched to busbar A	<b>SWITcher:INPA &lt;n&gt;</b>
Input B n	Channel n of input switcher is switched to busbar B	<b>SWITcher:INPB &lt;n&gt;</b>
Output A n	Channel n of output switcher is switched to busbar A	<b>SWITcher:OUTA &lt;n&gt;</b>
Output B n	Channel n of output switcher is switched to busbar B	<b>SWITcher:OUTB &lt;n&gt;</b>
Tracking OFF B vs A OUT vs INP ALL	An additional selection window is opened for channel tracking. without tracking only busbar B versus A only output versus input both tracking modes simultaneously	<b>SWITcher:TRACKing OFF</b> <b>SWITcher:TRACKing BVSA</b> <b>SWITcher:TRACKing OVSI</b> <b>SWITcher:TRACKing ALL</b>
B vs A n	The channel on busbar B is offset by <n> versus A	<b>SWITcher:OFFSet:BVSA &lt;n&gt;</b>
Out vs Inp n	The channel of the output switcher is offset by <n> versus the input switcher	<b>SWITcher:OFFSet:OVSI &lt;n&gt;</b>

## 2.14 Remote Control of R&S UPZ

The commands listed in the tables can be used to generate a remote control program for setting one or several R&S UPZ.

The Audio Analyzers are controlled by an external PC and the control their connected switchers via RS232 or USB.

The following table gives an overview regarding the possibilities of remote controlling:

*Table 2-4 Possibilities of remote controlling*

Audioanalyzer	Controlling the Audio Analyzer by an external PC	Controlling the R&S UPZ from the Audio Analyzer
<b>R&amp;S UPL</b>	COM IEC Bus	COM
<b>R&amp;S UPV</b>	COM IEC Bus LAN	COM USB Device
<b>R&amp;S UPP</b>	IEC Bus LAN USB Device	USB Device

The RS-232-C commands (see section 4 [Remote Control via an External PC](#) on page 58) are used to control the R&S UPZ directly from a PC.

## 3 Applications



Since the signal path of the R&S UPZ is a pure relay switching matrix, its use is not limited to audio frequency applications. It is possible to switch AES/EBU-coded signals by means of a R&S UPZ, for example. Due to the impedance of the connectors and lines in the R&S UPZ, the cables used should not be too long.

### 3.1 Input Switcher

The fo

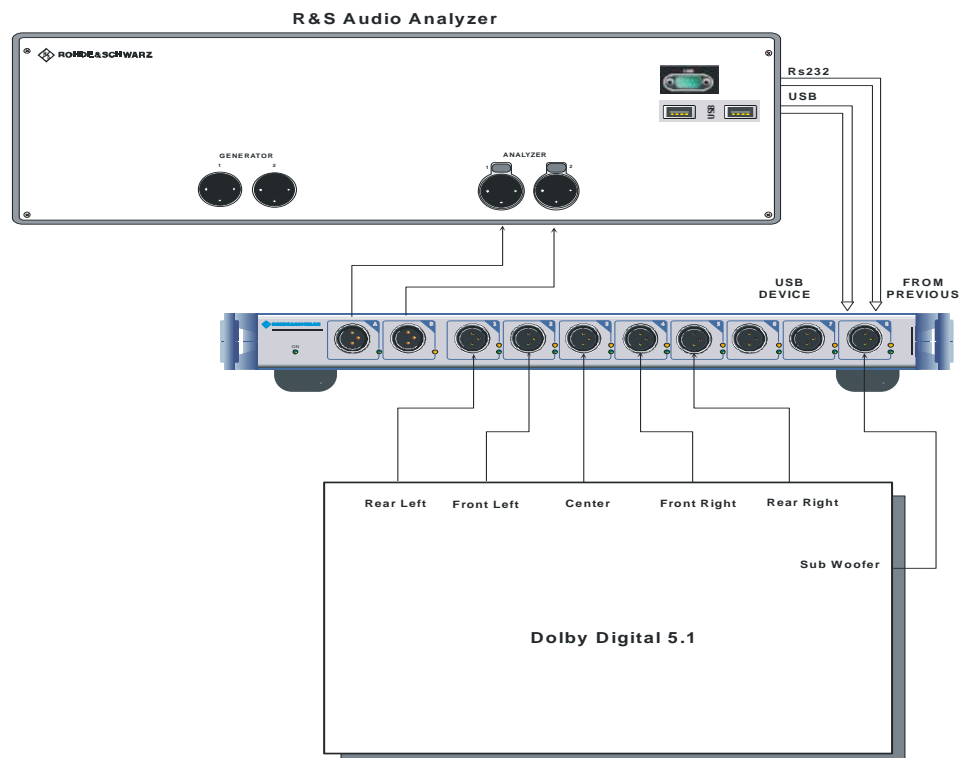

**Fig. 3-1 Use of input switcher**

A modern multichannel surround-sound system has 5 + 1 outputs, which control the associated loudspeakers. The first five outputs are identical whereas the additional channel is used to connect a subwoofer. These six signal outputs are connected to six inputs of an input switcher, so that the Audio Analyzer can measure the surround-sound system without having to recable the connection.



## 3.2 Output switcher

The following basic diagram shows a typical application of an output switcher.

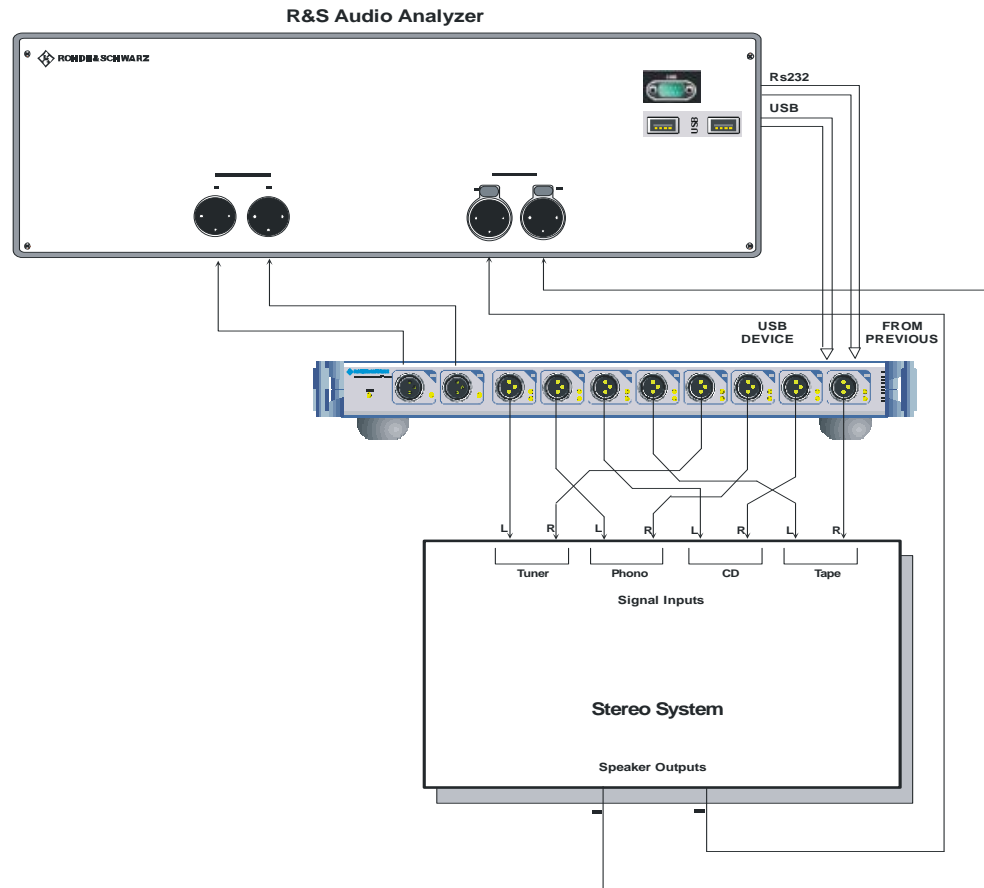

**Fig. 3-2** Use of output switcher

A commercial stereo system generally has several inputs for feeding signals. The generator has a dual-channel connection to busbars **A** and **B**. The output switcher controls the individual inputs of the stereo system. Their loudspeaker outputs are then connected to the analyzer inputs. Thus, up to four inputs (each with left and right channel) of the stereo system can be sequentially routed to the two inputs and measured without modifying the cabling. Only the inputs of the stereo system have to be manually switched over because this cannot be done by the remote control via the Audio Analyzer.

If the output switcher is suitably connected, the channels can be set step by step. To do this, all left inputs of the stereo system are switched to busbar **A**, and all right inputs to busbar **B** (see Fig. 3-2). The number of inputs to be measured (4 in the above example) is used as tracking (channel offset). Thus, the left inputs are on 1, 2, 3 and 4, whereas the right inputs are on 5, 6, 7 and 8. With a step width of 1, the stereo inputs can easily be through-connected.

The output switcher has a special feature: After channel number  $-1$  has been entered, the output switcher can through-connect all signal paths in busbar **B**, except the path selected for busbar **A**. This setting allows, for example, worst-case crosstalk measurements, in which the coupled residual signal is measured in one channel and all other channels are driven.

### 3.3 Combined Use of Input and Output Switcher

The following basic diagram shows an application where an input and an output switcher are used.

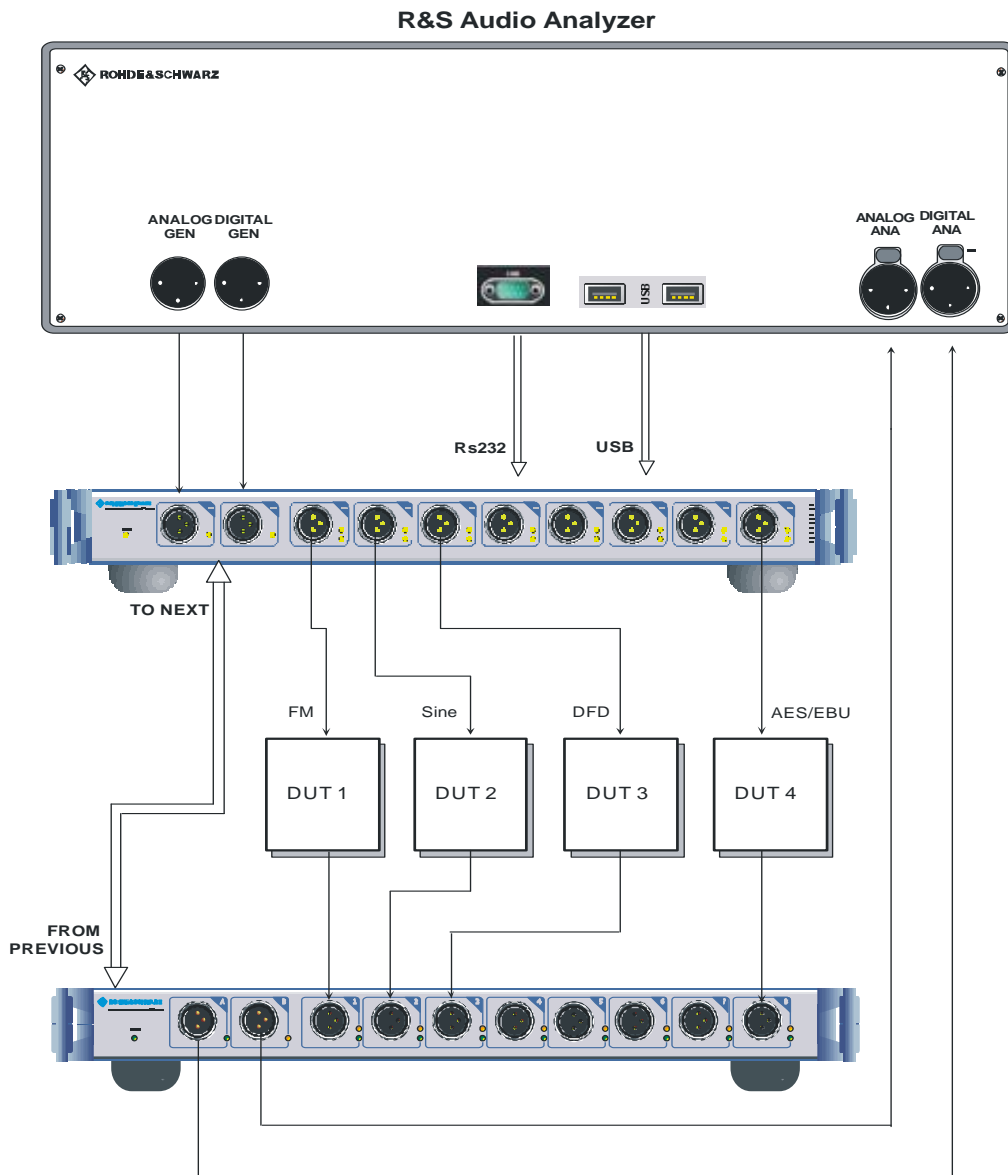

**Fig. 3-3 Use of input and output switcher**

Since an Audio Analyzer does not only generate the most usual sinusoidal signals for analog audio systems, but for instance also SPDIF Signals, it is possible to supply even most different DUTs with the correct input signal by means of the Audio Analyzer and two R&S UPZ without recabling (see above). Thus, the correct stimulus signal is provided for different test setups or measuring instruments in order to obtain conclusive results.

The input and the output switcher can be set to the same address.

## 4 Remote Control via an External PC

The R&S UPZ can be remotely controlled by means of a PC in two different ways:

- Via an Audio Analyzer
- Via the RS-232-C interface

The first possibility has been already described. The following manual explains remote control via the RS-232-C interface by an external PC.

### 4.1 Brief Instructions

The instrument is equipped with two RS-232-C interfaces as standard. The interfaces on the rear panel are used to connect an Audio Analyzer or a PC for remote control as well as other R&S UPZ, if required.

Some modifications have been made to enable several R&S UPZ to be simultaneously operated at this serial interface. These modifications do not allow normal handshake operation.



In contrast to manual control, which to give optimum operating convenience, remote control is to ensure a predictable device status after a command. This means that after an attempt to perform incompatible settings, for example, the command is rejected and the device status remains unchanged without other settings being modified. Therefore, RS-232-C control programs should always set a default status (e.g. with the \*RST command) and then make the required settings.

If the R&S UPZ is not controlled via the R&S UPL but via a PC, the special features of the modified RS-232-C interfaces must be taken into account.

The normal handshake is not used for control in order to allow cascading. Data exchange is bidirectional but only sequential. This is necessary to prevent two or more R&S UPZ from sending data simultaneously so that their data would be superimposed on each other or even corrupted.

### 4.2 Hardware Interfaces

#### 4.2.1 RS-232-C interface

The R&S UPZ is equipped with two RS-232-C interfaces as standard.

The 9-contact female connector labelled FROM PREVIOUS is used to connect the PC to the R&S UPZ.

The 9-contact male connector labelled TO NEXT serves for connecting the next R&S UPZ when several switchers are cascaded.

The connectors are wired differently in order to ensure smooth communication by means of normal RS-232-C extension cables independently of the complexity of the setup. This is shown in Fig. 4-1.

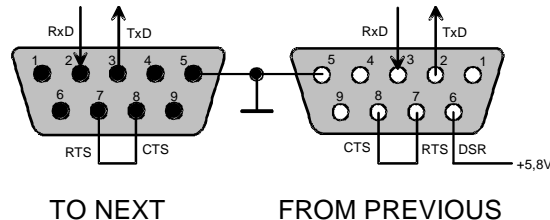

Fig. 4-1 Pin assignment of the D-sub connectors

## 4.2.2 Characteristics of the Interface

- Serial data transmission in asynchronous mode
- Bidirectional sequential data transmission via two separate lines
- Permanent transmission rate of 19200 baud
- Signal level logic 0 from +3 V to +15 V
- Signal level logic 1 from -3 V to -15 V
- Hardware handshake RTS/CTS

## 4.2.3 Signal lines

<b>RxD</b> (Receive Data)	(Receive Data) Input; data line for transmission from the controlling instrument to the R&S UPZ
<b>TxD</b> (Transmit Data)	(Transmit Data) Output; data line for transmission from the R&S UPZ to the controlling instrument
<b>DSR</b> (Data Set Ready)	(Data Set Ready) Output; a high level informs the controlling instrument that the R&S UPZ is ready for operation
<b>GND</b> (Ground)	(Ground) Interface ground, connected to the R&S UPZ ground
<b>RTS</b> (Request To Send)	(Request To Send) Output; the R&S UPZ informs the controlling instrument that it is ready to receive
<b>CTS</b> (Clear To Send)	(Clear To Send) The controlling instrument informs the R&S UPZ that it can send data.

## 4.2.4 Transmission Parameters

To ensure error-free and correct data transmission, the transmission parameters set on the PC must be adapted to those of the R&S UPZ.

Transmission rate (baud rate)	The R&S UPZ baud rate is permanently set to 19200 baud and cannot be changed. The controlling instrument has to adapt its rate to that of the R&S UPZ.
Data bits	Data is transmitted in 8-bit ASCII code. The least significant bit is the first bit transmitted
Start bit	Each data byte begins with a start bit. The falling edge of the start bit indicates the beginning of the data byte.
Parity bit	A parity bit is <b>not</b> used.
Stop bit	A stop bit terminates the transmission of a data byte.
Handshake	A software handshake is switched off (OFF)

The table below contains only a query, which triggers the identification of a R&S UPZ and a setting command, which performs a channel setting. To comply with the standardized SCPI commands the \*RST command has been included, which ensures that all R&S UPZ connected switch off their relays and thus open all channels.

**Table 4-1 Control commands and queries for the R&S UPZ**

Command	Parameter	Remarks
a<addr><type>*idn?<NL>	<addr> = ASCII 0 to 15, address of the R&S UPZ <type> = ASCII i, o, I or O, input or output switcher	Identification query of the controlling instrument to the R&S UPZ  The response of the R&S UPZ is: Rohde & Schwarz, UPZ, <x>, <y> <x> = Firmware version <y> = Hardware version = Board ID
*RST	-	Default setting of the R&S UPZ with all channels open
<type><channel><relais><NL>	<type> = Input or output switcher, see above <channel> = ASCII a(A) or b(B), busbar A or B <relais> = -1 to 128, channel number in the R&S UPZ	Channel setting in an input or output switcher.  When the channel number is modified, the previous channel is automatically switched off.  Channel No. 0: all channels are open.

### Example 1:

a0i\*idn?<NL> (identification query to an input switcher at address 0)

### Example 2:

a0i\*idn?<NL> (identification query to an output switcher at address 5)

**Example 3:**

various channel settings

ia5<NL>	Channel 5 of an input switcher at address 0 is switched to busbar <b>A</b> .
ib6<NL>	Channel 6 of an input switcher at address 0 is switched to busbar <b>B</b> .
oa122<NL>	Channel 2 of an output switcher at address 15 is switched to busbar <b>A</b> .
ob128<NL>	Channel 8 of an output switcher at address 15 is switched to busbar <b>B</b> .

If a channel setting command is sent to any switcher, the channel that was previously active is automatically opened. All R&S UPZ receive the command simultaneously and the addressed one executes the setting command. All other R&S UPZ either ignore it (when their channels are inactive) or open a previously selected channel. Thus, only 1-out-of-n channel selection is possible (except for the output switcher, see example 4).

**Example 4:**

oa19 ... ob-1 Output-Switcher mit „-1“

Channel 3 of a R&S UPZ at address 2 is switched to busbar A. Busbar B has connected all channels, except channel 3 (= 19 on counting the possible channels from 0 to 128).

## 4.3 Special Channel Settings

The following special features have to be taken into account when setting the channels directly from the PC via RS-232-C:

- Channel No. 0 opens all channels of the busbar used on all connected switchers.
- There is no explicit tracking command. The calculation and automatic adaptation of the other channels with tracking switched on (control via the R&S UPL) is implemented in the R&S UPL and must be simulated by the program for direct control via a PC.
- If the same channel is selected for the two busbars via the RS-232-C interface directly from a PC program, the R&S UPZ blocks this setting in order to avoid shorts of two generators (output switcher used) or double loading of the connected generator (input switcher used).

The command sent last is always executed, which means that the selected channel is connected to the selected busbar. If this channel was previously connected to the other busbar, this connection is undone.

**Example:**

- Channel 3 is connected to busbar A. Then, the R&S UPZ receives the command to connect channel 3 to busbar B. Channel 3 and busbar A are disconnected (relay opened) and channel 3 is connected to busbar B.

The behaviour differs from the operation via the R&S UPL. There, the channel previously selected on the other busbar is skipped (see section 2.5).

- Commands that are not understood by the R&S UPZ are ignored and do not generate an error message
- If an attempt is made to set a channel, which is outside of the range of the switcher connected, the channel previously active is opened. However, the new one cannot be set. But no error message is output! The channel range monitoring facility, which generates the error message described in section 2.5, is performed exclusively in the R&S UPL. This also applies to a channel entry >128.
- The entry of a value <-1 (for the output switcher) is interpreted as unknown command and therefore ignored.
- The setting command "-1" described in example 4 for the output switcher may be entered for the two busbars via a PC. The last command again overwrites the previous setting.

If all channels of busbar B were previously switched on with `ob-1<NL>` (except the channel selected in A) and the command `oa-1<NL>` is then sent, all channels are connected to busbar A (except the channel previously selected in A). The channel previously connected to busbar A is now the only one that is connected to busbar B.

**Example:**

Channel 3 is connected to busbar A, channels 1 and 2 as well as 4 to 8 to busbar B (`oa3<NL>` and `ob-1<NL>`). When `oa-1<NL>` is entered, channel 3 is connected to busbar B and all other channels to busbar A.



## 5 Maintenance

The following section provides instructions for maintenance, storage and packaging of the R&S UPZ.

### 5.1 Mechanical Maintenance

The instrument does not need a periodic maintenance. Only the cleaning of the instrument is essential. The outside of the instrument is suitably cleaned using a soft, lint-free dust cloth. Make sure that the air vents are not obstructed.

---

**⚠ WARNING****Shock hazard**

Before cleaning the instrument, make sure that the instrument is switched off and disconnected from all power supplies.

---

---

**NOTICE****Instrument damage caused by cleaning agents**

Cleaning agents contain substances that may damage the instrument, e.g. cleaning agents that contain a solvent may damage the front panel labeling or plastic parts. Never use cleaning agents such as solvents (thinners, acetone, etc), acids, bases, or other substances.

The outside of the instrument can be cleaned sufficiently using a soft, lint-free dust cloth.

---

Follow the instructions in the service manual and the safety instructions when exchanging modules or ordering spares. The order no. for spare parts is included in the service manual, as well as further information on troubleshooting and repair. The Service Manual The service manual is available as PDF file on the user documentation CD ROM (included in delivery).

## 5.2 Electrical Maintenance

The R&S UPZ usually does not require any electrical maintenance. To ensure correct operation in compliance with data sheet specifications over a long time, it is recommended to have the specifications checked in a Rohde & Schwarz agency at intervals of 3 years. This concerns in particular the insertion loss, which may increase in the course of time due to aging of relays caused by switching or as a result of the corrosion of the XLR contacts in an aggressive environment.

It is recommended to check the specifications according to the performance test described in chapter 1 of Service Manual.

The address of our support center and a list of all Rohde & Schwarz service centers can be found at the beginning of this manual.

## 5.3 Storage and Packaging

The storage temperature range of the instrument is given in the data sheet. If the instrument is to be stored for a longer period of time, it must be protected against dust.

Repack the instrument as it was originally packed when transporting or shipping. The two protective foam plastic parts prevent the control elements and connectors from being damaged. The antistatic packing foil avoids any undesired electrostatic charging to occur.

If you do not use the original packaging, use a sturdy cardboard box of suitable size and provide for sufficient padding to prevent the instrument from slipping inside the package. Wrap antistatic packing foil around the instrument to protect it from electrostatic charging.