

# Keysight N8262A P-Series Modular Power Meter



Programming  
Guide

# Notices

## Copyright Notice

© Keysight Technologies 2007–2020  
No part of this manual may be reproduced in any form or by any means (including electronic storage and retrieval or translation into a foreign language) without prior agreement and written consent from Keysight Technologies as governed by United States and international copyright laws.

## Manual Part Number

N8262-90008

## Edition

Edition 7, September 18, 2020

## Printed in:

Printed in Malaysia

## Published by:

Keysight Technologies  
Bayan Lepas Free Industrial Zone,  
11900 Penang, Malaysia

## Technology Licenses

The hardware and/or software described in this document are furnished under a license and may be used or copied only in accordance with the terms of such license.

## Declaration of Conformity

Declarations of Conformity for this product and for other Keysight products may be downloaded from the Web. Go to <http://www.keysight.com/go/conformity>. You can then search by product number to find the latest Declaration of Conformity.

## U.S. Government Rights

The Software is “commercial computer software,” as defined by Federal Acquisition Regulation (“FAR”) 2.101. Pursuant to FAR 12.212 and 27.405-3 and Department of Defense FAR Supplement (“DFARS”) 227.7202, the U.S. government acquires commercial computer software under the same terms by which the software is customarily provided to the public. Accordingly, Keysight provides the Software to U.S. government customers under its standard commercial license, which is embodied in its End User License Agreement (EULA), a copy of which can be found at <http://www.keysight.com/find/sweula>. The license set forth in the EULA represents the exclusive authority by which the U.S. government may use, modify, distribute, or disclose the Software. The EULA and the license set forth therein, does not require or permit, among other things, that Keysight: (1) Furnish technical information related to commercial computer software or commercial computer software documentation that is not customarily provided to the public; or (2) Relinquish to, or otherwise provide, the government rights in excess of these rights customarily provided to the public to use, modify, reproduce, release, perform, display, or disclose commercial computer software or commercial computer software documentation. No additional government requirements beyond those set forth in the EULA shall apply, except to the extent that those terms, rights, or licenses are explicitly required from all providers of commercial computer software pursuant to the FAR and the DFARS and are set forth specifically in writing elsewhere in the EULA. Keysight shall be under no obligation to update, revise or otherwise modify the Software. With respect to any technical data as defined by FAR 2.101, pursuant to FAR 12.211 and 27.404.2 and DFARS 227.7102, the U.S. government acquires no greater than Limited Rights as defined in FAR 27.401 or DFAR 227.7103-5 (c), as applicable in any technical data.

## Warranty

THE MATERIAL CONTAINED IN THIS DOCUMENT IS PROVIDED “AS IS,” AND IS SUBJECT TO BEING CHANGED, WITHOUT NOTICE, IN FUTURE EDITIONS. FURTHER, TO THE MAXIMUM EXTENT PERMITTED BY APPLICABLE LAW, KEYSIGHT DISCLAIMS ALL WARRANTIES, EITHER EXPRESS OR IMPLIED, WITH REGARD TO THIS MANUAL AND ANY INFORMATION CONTAINED HEREIN, INCLUDING BUT NOT LIMITED TO THE IMPLIED WARRANTIES OF MERCHANTABILITY AND FITNESS FOR A PARTICULAR PURPOSE. KEYSIGHT SHALL NOT BE LIABLE FOR ERRORS OR FOR INCIDENTAL OR CONSEQUENTIAL DAMAGES IN CONNECTION WITH THE FURNISHING, USE, OR PERFORMANCE OF THIS DOCUMENT OR OF ANY INFORMATION CONTAINED HEREIN. SHOULD KEYSIGHT AND THE USER HAVE A SEPARATE WRITTEN AGREEMENT WITH WARRANTY TERMS COVERING THE MATERIAL IN THIS DOCUMENT THAT CONFLICT WITH THESE TERMS, THE WARRANTY TERMS IN THE SEPARATE AGREEMENT SHALL CONTROL.

## Safety Information

### CAUTION

A CAUTION notice denotes a hazard. It calls attention to an operating procedure, practice, or the like that, if not correctly performed or adhered to, could result in damage to the product or loss of important data. Do not proceed beyond a CAUTION notice until the indicated conditions are fully understood and met.

### WARNING

A WARNING notice denotes a hazard. It calls attention to an operating procedure, practice, or the like that, if not correctly performed or adhered to, could result in personal injury or death. Do not proceed beyond a WARNING notice until the indicated conditions are fully understood and met.

## General Warranty

The material contained in this document is provided “as is,” and is subject to being changed, without notice, in future editions. Further, to the maximum extent permitted by applicable law, Keysight disclaims all warranties, either express or implied with regard to this manual and any information contained herein, including but not limited to the implied warranties of merchantability and fitness for a particular purpose. Keysight shall not be liable for errors or for incidental or consequential damages in connection with the furnishing, use, or performance of this document or any information contained herein. Should Keysight and the user have a separate written agreement with warranty terms covering the material in this document that conflict with these terms, the warranty terms in the separate agreement shall control. Duration and conditions of warranty for this product may be superseded when the product is integrated into (becomes a part of) other Keysight products. During the warranty period, Keysight will, at its option, either repair or replace products which prove to be defective. The warranty period begins on the date of delivery or on the date of installation if installed by Keysight.

## Restricted Rights Legend

The Software and Documentation have been developed entirely at private expense. They are delivered and licensed as “commercial computer software” as defined in DFARS 252.227-7013 (Oct 1988), DFARS 252.211-7015 (May 1991), or DFARS 252.227-7014 (Jun 1995), as a “commercial item” as defined in FAR 2.101(a), or as “restricted computer software” as defined in FAR 52.227-19 (Jun 1987) (or any equivalent agency regulation or contract clause), whichever is applicable. You have only those rights provided for such Software and Documentation by the applicable FAR or DFARS clause or the Keysight standard software agreement for the product involved.

# Equipment Operation

## Warnings and Cautions

This guide uses warnings and cautions to denote hazards.

### **WARNING**

A **WARNING** notice denotes a hazard. It calls attention to an operating procedure, practice, or the like that, if not correctly performed or adhered to, could result in personal injury or loss of life. Do not proceed beyond a **WARNING** notice until the indicated conditions are fully understood and met.

---

### **CAUTION**

A **CAUTION** notice denotes a hazard. It calls attention to an operating procedure, practice, or the like that, if not correctly performed or adhered to, could result in damage to the product or loss of important data. Do not proceed beyond a **CAUTION** notice until the indicated conditions are fully understood and met.

---

## Personal Safety Considerations

This is a Safety Class I product (provided with a protective earthing ground incorporated in the power cord). The mains plug shall only be inserted in a socket outlet provided with a protective earth contact. Any interruption of the protective conductor, inside or outside the instrument, is likely to make the instrument dangerous. Intentional interruption is prohibited. If this instrument is not used as specified, the protection provided by the equipment could be impaired. This instrument must be used in a normal condition (in which all means of protection are intact) only.

No operator serviceable parts inside. Refer servicing to qualified personnel. To prevent electrical shock, do not remove covers. For continued protection against fire hazard, replace the line fuse(s) only with fuses of the same type and rating (for example, normal blow, time delay, etc.). The use of other fuses or material is prohibited.

## General Safety Considerations

The following general safety precautions must be observed during all phases of operation of this instrument. Failure to comply with these precautions or with specific warnings elsewhere in this manual violates safety standards of design, manufacture, and intended use of the instrument. Keysight Technologies, Inc. assumes no liability for the customer's failure to comply with these requirements.

### WARNING

- Before this instrument is switched on, make sure it has been properly grounded through the protective conductor of the ac power cable to a socket outlet provided with protective earth contact. Any interruption of the protective (grounding) conductor, inside or outside the instrument, or disconnection of the protective earth terminal can result in personal injury.
- 

### CAUTION

- Any adjustments or service procedures that require operation of the instrument with protective covers removed should be performed only by trained service personnel.
- 

## User Environment

This instrument is designed for indoor use only.

THIS PAGE HAS BEEN INTENTIONALLY LEFT BLANK.

# Table of Contents

General Warranty	3
Restricted Rights Legend	3
Equipment Operation	4
Warnings and Cautions	4
Personal Safety Considerations	4
General Safety Considerations	5
User Environment	5
<b>1 Power Meter Remote Operation</b>	
Introduction	56
Configuring the Remote Interface	57
LAN Configuration	57
Zeroing and Calibrating the P-Series Power Sensor	59
Zeroing	59
Calibration	59
Making Measurement	61
Using MEASure?	62
Using the CONFigure Command	67
Using the Lower Level Commands	75
Using Frequency Dependent Offset Tables	77
Overview	77
Editing Frequency Dependent Offset Tables	79
Selecting a Frequency Dependent Offset Table	82
Enabling a Frequency Dependent Offset Table	82
Making the Measurement	82
Setting the Range, Resolution and Averaging	84
Resolution	84
Averaging	84
Auto Averaging Mode	85
Filter Length	86

Range .....	86
Setting Offsets .....	88
Channel Offsets .....	88
Display Offsets .....	88
Setting Measurement Limits .....	90
Setting Limits .....	90
Checking for Limit Failures .....	92
Using STATus .....	93
Getting the Best Speed Performance .....	94
Measurement Rate .....	94
Sensor .....	95
Trigger Mode .....	95
Output Format .....	97
Units .....	97
Command Used .....	97
Fast Mode .....	98
How Measurements are Calculated .....	99
Status Reporting .....	100
The General Status Register Model .....	100
How to Use Register .....	103
The Condition Polling Method .....	103
Device Status Register .....	104
Using the Operation Complete Commands .....	105
Saving and Recalling Power Meter Configurations .....	106
How to Save and Recall a Configuration .....	106
Using Device Clear to Halt Measurements .....	107
An Introduction to the SCPI Language .....	108
Mnemonic Forms .....	108
Using a Colon (:)	108
Using a Semicolon (;)	109
Using a Comma (,)	109
Using Whitespace .....	109
Using “?” Commands .....	109



Using “*” Commands	110
Syntax Conventions	110
Syntax Diagram Conventions	110
SCPI Data Types	111
Input Message Terminators	116
SCPI Compliance Information	117
Summary of Commands	119
Making Measurements on Wireless Communication Standards	120
Starting a Preset Example	121
<b>2 MEASurement Commands</b>	
MEASurement Commands	125
Optional Parameters	126
CONFigure[1]  2 3 4?	130
Syntax	130
Example	131
Reset Condition	131
CONFigure [1]  2 3 4 Commands	132
CONFigure[1] 2 3 4[:SCALar][:POWER:AC]	
[<expected_value>[,<resolution>[,<source list>]]]	133
Syntax	133
Parameters	133
Example	134
CONFigure[1] 2 3 4[:SCALar][:POWER:AC]:RELative	
[<expected_value>[,<resolution>[,<source list>]]]	135
Syntax	135
Parameters	135
Example	136
CONFigure[1] 2 3 4[:SCALar][:POWER:AC]:DIFFerence	
[<expected_value>[,<resolution>[,<source list>]]]	137
Syntax	137
Parameters	137
Example	138

CONFigure[1] 2 3 4[:SCALar][:POWer:AC]:DIFFerence:	
RELative [<expected_value>[,<resolution>[,<source list>]]]	139
Syntax	139
Parameters	139
Example	140
CONFigure[1] 2 3 4[:SCALar][:POWer:AC]:RATio	
[<expected_value>[,<resolution>[,<source list>]]]	141
Syntax	141
Parameters	141
Example	142
CONFigure[1] 2 3 4[:SCALar][:POWer:AC]:RATio:	
RELative[<expected_value>[,<resolution>[,<source list>]]]	143
Syntax	143
Parameters	143
Example	144
FETCh[1] 2 3 4 Queries	145
FETCh[1] 2 3 4[:SCALar][:POWer:AC]? [<expected_value>[,<resolu-	
tion>[,<source list>]]]	146
Syntax	146
Parameters	146
Example	147
Error Messages	147
FETCh[1] 2 3 4[:SCALar][:POWer:AC]:RELative?	
[<expected_value>[,<resolution>[,<source list>]]]	148
Syntax	148
Parameters	148
Example	149
Error Messages	149
FETCh[1] 2 3 4[:SCALar][:POWer:AC]:DIFFerence?	
[<expected_value>[,<resolution>[,<source list>]]]	150
Syntax	150
Parameters	150
Example	151
Error Messages	151

FETCh[1] 2 3 4[:SCALar][:POWer:AC]:DIFFerence: RELative? [<expected_value>[,<resolution>[,<source list>]]]	152
Syntax	152
Parameters	152
Example	153
Error Messages	153
FETCh[1] 2 3 4[:SCALar][:POWer:AC]:RATio? [<expected_value>[,<resolution>[,<source list>]]]	154
Syntax	154
Parameters	154
Example	155
Error Messages	155
FETCh[1] 2 3 4[:SCALar][:POWer:AC]:RATio:RELative? [<expected_val- ue>[,<resolution>[,<source list>]]]	156
Syntax	156
Parameters	156
Example	157
Error Messages	157
READ[1] 2 3 4 Commands	158
READ[1] 2 3 4[:SCALar][:POWer:AC]? [<expected_value>[,<resolu- tion>[,<source list>]]]	159
Syntax	159
Parameters	159
Example	160
Error Messages	160
READ[1] 2 3 4[:SCALar][:POWer:AC]:RELative? [<expected_value>[,<resolution>[,<source list>]]]	161
Syntax	161
Parameters	161
Example	162
Error Messages	162
READ[1] 2 3 4[:SCALar][:POWer:AC]:DIFFerence? [<expected_value>[,<resolution>[,<source list>]]]	163
Syntax	163

Parameters	163
Example	164
Error Messages	164
READ[1] 2 3 4[:SCALar][:POWer:AC]:DIFFerence:	
RELative? [<expected_value>[,<resolution>[,<source list>]]]	165
Syntax	165
Parameters	165
Example	166
Error Messages	166
READ[1] 2 3 4[:SCALar][:POWer:AC]:RATio? [<expected_value>[,<resolu-	
tion>[,<source list>]]]	167
Syntax	167
Parameters	167
Example	168
Error Messages	168
READ[1] 2 3 4[:SCALar][:POWer:AC]:RATio:RELative? [<expected_val-	
ue>[,<resolution>[,<source list>]]]	169
Syntax	169
Parameters	169
Example	170
Error Messages	170
MEASure[1] 2 3 4 Commands	171
MEASure[1] 2 3 4[:SCALar][:POWer:AC]? [<expected_value>[,<resolu-	
tion>[,<source list>]]]	172
Syntax	172
Parameters	172
Example	173
MEASure[1] 2 3 4[:SCALar][:POWer:AC]:RELative?	
[<expected_value>[,<resolution>[,<source list>]]]	174
Syntax	174
Parameters	174
Example	175
MEASure[1] 2 3 4[:SCALar][:POWer:AC]:DIFFerence? [<expected_val-	

ue>[,<resolution>[,<source list>]]]	176
Syntax	176
Parameters	176
Example	177
MEASure[1] 2 3 4[:SCALar][:POWer:AC]:DIFFerence:	
RELative? [<expected_value>[,<resolution>[,<source list>]]]	178
Syntax	178
Parameters	178
Example	179
MEASure[1] 2 3 4[:SCALar][:POWer:AC]:RATio?	
[<expected_value>[,<resolution>[,<source list>]]]	180
Syntax	180
Parameters	180
Example	181
MEASure[1] 2 3 4[:SCALar][:POWer:AC]:RATio:RELative? [<expected_val-	
ue>[,<resolution>[,<source list>]]]	182
Syntax	182
Parameters	182
Example	183
<b>3 CALCulate Subsystem</b>	
CALCulate Subsystem	186
CALCulate[1] 2 3 4:FEED[1] 2 <string>	189
Syntax	189
Parameters	190
Example	190
Reset Condition	190
Query	191
Query Example	191
Error Message	191
CALCulate[1] 2 3 4:GAIN Commands	192
CALCulate[1] 2 3 4:GAIN[:MAGNitude] <numeric_value>	193
Syntax	193
Parameters	193

Example	194
Reset Condition	194
Query	194
Query Example	194
Error Message	194
CALCulate[1] 2 3 4:GAIN:STATe <boolean>	195
Syntax	195
Example	195
Reset Condition	195
Query	195
Query Example	196
Error Message	196
CALCulate[1] 2 3 4:LIMit Commands	197
CALCulate[1] 2 3 4:LIMit:CLEar:AUTO <boolean> ONCE	198
Syntax	198
Example	199
Reset Condition	199
Query	199
Query Example	199
CALCulate[1] 2 3 4:LIMit:CLEar[:IMMEDIATE]	200
Syntax	200
Example	200
CALCulate[1] 2 3 4:LIMit:FAIL?	201
Syntax	201
Example	201
Reset Condition	201
CALCulate[1] 2 3 4:LIMit:FCOunt?	202
Syntax	203
Example	203
Reset Condition	203
CALCulate[1] 2 3 4:LIMit:LOWer[:DATA] <numeric_value>	204
Syntax	204
Parameters	205
Example	205

Reset Condition	205
Query	205
Query Example	205
CALCulate[1] 2 3 4:LIMit:UPPer[:DATA] <numeric_value>	206
Syntax	206
Parameters	207
Example	207
Reset Condition	207
Query	207
Query Example	208
CALCulate[1] 2 3 4:LIMit:STATe <boolean>	209
Syntax	209
Example	209
Reset Condition	209
Query	209
Query Example	210
Error Message	210
CALCulate[1] 2 3 4:MATH Commands	211
CALCulate[1] 2 3 4:MATH[:EXPRession] <string>	212
Syntax	212
Parameters	213
Example	213
Reset Condition	213
Query	214
Query Example	214
Error Messages	214
CALCulate[1] 2 3 4:MATH[:EXPRession]:CATalog?	215
Syntax	215
Example	215
CALCulate[1] 2 3 4:PHOLd:CLEar	216
Syntax	216
Example	216
Error Messages	216
CALCulate[1] 2 3 4:RELative Commands	217

CALCulate[1]]2]3]4:RELative[:MAGNitude]:AUTO <boolean> ONCE	.. 218
Syntax	..... 218
Example	..... 219
Query	..... 219
Error Message	..... 219
CALCulate[1]]2]3]4:RELative:STATe <boolean>	..... 220
Syntax	..... 220
Example	..... 220
Reset Condition	..... 220
Query	..... 220
Query Example	..... 221
Error Message	..... 221
<b>4 CALibration Subsystem</b>	
CALibration Subsystem	..... 224
CALibration[1]]2[:ALL]	..... 226
Syntax	..... 227
Example	..... 227
Error Messages	..... 227
CALibration[1]]2[:ALL]?	..... 228
Syntax	..... 229
Query Example	..... 229
Error Messages	..... 229
CALibration[1]]2:AUTO [ONCE ON OFF 0 1]	..... 230
Syntax	..... 231
Example	..... 231
Reset Condition	..... 231
Query	..... 231
Error Messages	..... 231
CALibration[1]]2:RCALibration <boolean>	..... 232
Syntax	..... 232
Example	..... 232
Reset Condition	..... 232
Query	..... 232



Query Example	233
Error Messages	233
CALibration[1] 2:RCFactor <numeric_value>	234
Syntax	235
Parameters	235
Example	235
Reset Condition	235
Query	236
Query Example	236
Error Messages	236
CALibration[1] 2:ZERO:AUTO [ONCE ON OFF 0 1]	237
Syntax	237
Example	237
Reset Condition	237
Query	238
Error Messages	238
CALibration[1] 2:ZERO:NORMal:AUTO <boolean>	239
Syntax	239
Example	239
Reset Condition	239
Query	240
Error Messages	240
<b>5 DISPLAY Subsystem</b>	
DISPlay Subsystem	242
DISPlay:ENABle <boolean>	243
Syntax	243
Example	243
Reset Condition	243
Query	243
Query Example	244
DISPlay:SCREen:FORMat <character_data>	245
Syntax	245
Parameters	245

Example	246
Reset Condition	246
Query	246
Query Example	246
DISPlay[:WINDow[1] 2] Commands	247
DISPlay[:WINDow[1] 2]:ANALog Commands	248
DISPlay[:WINDow[1] 2]:ANALog:LOWer <numeric_value>	249
Syntax	250
Parameters	250
Example	250
Reset Condition	251
Query	251
Query Example	251
DISPlay[:WINDow[1] 2]:ANALog:UPPer <numeric_value>	252
Syntax	253
Parameters	253
Example	253
Reset Condition	254
Query	254
Query Example	254
DISPlay[:WINDow[1] 2]:FORMat <character_data>	255
Syntax	255
Parameters	256
Example	256
Reset Condition	256
Query	257
Query Example	257
Error Messages	257
DISPlay[:WINDow[1] 2]:METer Commands	258
DISPlay[:WINDow[1] 2]:METer:LOWer <numeric_value>	259
Syntax	260
Parameters	260
Example	260
Reset Condition	261

Query	261
Query Example	261
DISPlay[:WINDow[1] 2]:METer:UPPer <numeric_value>	262
Syntax	263
Parameters	263
Example	263
Reset Condition	264
Query	264
Query Example	264
DISPlay[:WINDow[1] 2][:NUMeric[1] 2]:RESolution <numeric_value>	265
Syntax	265
Parameters	265
Example	266
Reset Condition	266
Query	266
Query Example	266
DISPlay[:WINDow[1] 2]:SELEct[1] 2	267
Syntax	267
Example	267
Reset Condition	267
Query	268
Query Example	268
DISPlay[:WINDow[1] 2][:STATe] <boolean>	269
Syntax	269
Examples	269
Reset Condition	269
Query	270
Query Example	270
DISPlay[:WINDow[1] 2]:TRACe:FEED <character_data>	271
Syntax	272
Parameters	272
Example	272
Reset Condition	273
Query	273
Query Example	273

## 6 FORMat Subsystem

FORMat Subsystem	276
FORMat[:READings]:BORDER <character_data>	277
Syntax	277
Parameters	277
Example	277
Reset Condition	277
Query	278
Query Example	278
FORMat[:READings][:DATA] <character_data>	279
Syntax	279
Parameters	279
Example	280
Reset Condition	280
Query	280
Query Example	280

## 7 MEMory Subsystem

MEMory Subsystem	282
MEMory:CATalog Commands	284
MEMory:CATalog[:ALL]?	285
Syntax	286
Example	286
MEMory:CATalog:STATe?	287
Syntax	287
Example	287
MEMory:CATalog:TABLE?	288
Syntax	290
Example	290
MEMory:CLEar Commands	291
MEMory:CLEar[:NAME] <character_data>	292
Syntax	293
Parameters	293

Example	293
Error Messages	293
MEMory:CLEar:TABLE	294
Syntax	294
Example	294
Error Message	294
MEMory:FREE Commands	295
MEMory:FREE[:ALL]?	296
Syntax	296
Example	296
MEMory:FREE:STATe?	297
Syntax	297
Example	297
MEMory:FREE:TABLE?	298
Syntax	298
Example	298
MEMory:NStates?	299
Syntax	299
Example	299
MEMory:STATe Commands	300
MEMory:STATe:CATalog?	301
Syntax	301
Example	301
MEMory:STATe:DEFine <character_data>,<numeric_value>	302
Syntax	302
Parameters	302
Example	302
Query	302
Query Example	303
Error Messages	303
MEMory:TABLE Commands	304
MEMory:TABLE:FREQuency <numeric_value>{,<numeric_value>}	305

Syntax	306
Parameters	306
Example	307
Query	307
Query Example	307
Error Messages	307
MEMory:TABLE:FREQuency:POINts?	308
Syntax	308
Example	308
MEMory:TABLE:GAIN[:MAGNitude] <numeric_value>{,<numeric_value>}	309
Syntax	310
Parameters	310
Example	310
Query	310
Query Example	311
Error Messages	311
MEMory:TABLE:GAIN[:MAGNitude]:POINts?	312
Syntax	312
Example	312
MEMory:TABLE:MOVE <character_data>,<character_data>	313
Syntax	313
Parameters	313
Example	313
Error Messages	313
MEMory:TABLE:SElect <character_data>	314
Syntax	314
Parameters	314
Example	314
Query	314
<b>8</b> <b>OUTPut Subsystem</b>	
OUTPut Subsystem	316
OUTPut:REcorder[1] 2:FEED <data_handle>	317

Syntax	317
Parameters	317
Example	317
Reset Condition	317
Query	318
Query Example	318
OUTPut:RECOder[1] 2:LIMit:LOWer <numeric_value>	319
Syntax	319
Parameters	319
Example	319
Reset Condition	319
Query	320
Query Example	320
OUTPut:RECOder[1] 2:LIMit:UPPer <numeric_value>	321
Syntax	321
Parameters	321
Example	321
Reset Condition	321
Query	322
Query Example	322
OUTPut:RECOder[1] 2:STATe <boolean>	323
Syntax	323
Example	323
Reset Condition	323
Query	323
Query Example	323
OUTPut:ROSCillator[:STATe] <boolean>	324
Syntax	324
Example	324
Reset Condition	324
Query	324
Query Example	324
OUTPut:TRIGger[:STATe] <boolean>	325
Syntax	325

Example	325
Reset Condition	325
Query	325
Query Example	325
<b>9 PStatistic Subsystem</b>	
PStatistic Subsystem	328
PStatistic[1]2:CCDF:DATA?	329
Syntax	329
Example	329
Error Messages	330
PStatistic[1]2:CCDF:DATA:MAX <numeric_value>	331
Syntax	331
Parameters	331
Example	331
Reset Condition	331
Query	332
Query Example	332
Error Messages	332
PStatistic[1]2:CCDF:POWER? <numeric_value>	333
Syntax	333
Parameters	333
Example	333
Error Messages	334
PStatistic[1]2:CCDF:PROBability? <numeric_value>	335
Syntax	335
Parameters	335
Example	336
Error Messages	336
PStatistic[1]2:CCDF:TABLE?	337
Syntax	338
Example	338
Error Messages	339



## 10 SENSE Subsystem

[SENSe] Subsystem	343
[SENSe[1]] SENSe2:AVERage Commands	346
[SENSe[1]] SENSe2:AVERage:COUNT <numeric_value>	347
Syntax	348
Parameters	348
Example	348
Reset Condition	348
Query	349
Query Example	349
[SENSe[1]] SENSe2:AVERage:COUNT:AUTO <boolean>	350
Syntax	351
Example	351
Reset Condition	351
Query	351
Query Example	352
Error Messages	352
[SENSe[1]] SENSe2:AVERage:SDETect <boolean>	353
Syntax	354
Example	354
Reset Condition	354
Query	354
Query Example	354
[SENSe[1]] SENSe2:AVERage[:STATE] <boolean>	355
Syntax	355
Example	355
Reset Condition	355
Query	355
Query Example	356
Error Messages	356
[SENSe[1]] SENSe2:AVERage2 Commands	357
[SENSe[1]] SENSe2:AVERage2:COUNT <numeric_value>	358
Syntax	358
Parameters	358

Example	358
Reset Condition	358
Query	359
Query Example	359
Error Messages	359
[SENSe[1]] SENSe2:AVERage2[:STATe] <boolean>	360
Syntax	360
Example	360
Reset Condition	360
Query	360
Query Example	361
Error Messages	361
[SENSe[1]] SENSe2:BANDwidth BWIDth:VIDeo <character_data>	362
Syntax	362
Parameters	362
Example	362
Reset Condition	362
Query	363
Query Example	363
Error Messages	363
[SENSe[1]] SENSe2:CORRection Commands	364
[SENSe[1]] SENSe2:CORRection:CFACtor GAIN[1][:INPut]	
[:MAGNitude] <numeric_value>	365
Syntax	365
Parameters	366
Example	366
Reset Condition	366
Query	366
Query Example	367
Error Messages	367
[SENSe[1]] SENSe2:CORRection:CSET[1] CSET2 Commands	368
[SENSe[1]] SENSe2:CORRection:CSET[1] CSET2[:SElect] <string>	369
Syntax	369
Parameters	369

Example	370
Reset Condition	370
Query	370
Query Example	370
Error Messages	370
[SENSe[1]] SENSe2:CORRection:CSET[1] CSET2:STATe <boolean>	371
Syntax	371
Example	371
Reset Condition	371
Query	372
Query Example	372
Error Messages	372
[SENSe[1]] SENSe2:CORRection:DCYClE GAIN3 Commands	373
[SENSe[1]] SENSe2:CORRection:DCYClE GAIN3[:INPut]	
[:MAGNitude] <numeric_value>	374
Syntax	375
Parameters	375
Example	375
Reset Condition	376
Query	376
Query Example	376
Error Messages	376
[SENSe[1]] SENSe2:CORRection:DCYClE GAIN3:STATe <boolean>	377
Syntax	377
Example	377
Reset Condition	377
Query	377
Query Example	378
Error Messages	378
[SENSe[1]] SENSe2:CORRection:FDOFFset GAIN4[:INPut]	
[:MAGNitude]?	379
Syntax	379
Example	379
Reset Condition	379

[SENSe[1]] SENSe2:CORRection:GAIN2 Commands	380
[SENSe[1]] SENSe2:CORRection:GAIN2:STATe <boolean>	381
Syntax	381
Example	381
Reset Condition	381
Query	381
Query Example	382
Error Messages	382
[SENSe[1]] SENSe2:CORRection:GAIN2[:INPut][:MAGNitude] <numeric_value>	383
Syntax	383
Parameters	384
Example	384
Reset Condition	384
Query	384
Query Example	385
Error Messages	385
[SENSe[1]] SENSe2:FREQuency[:CW]:FIXed] <numeric_value>	386
Syntax	386
Parameters	387
Example	387
Reset Condition	387
Query	387
Query Example	387
[SENSe[1]] SENSe2:MRATe <character_data>	388
Syntax	389
Parameters	389
Example	389
Reset Condition	389
Query	389
Query Example	390
Error Messages	390
[SENSe[1]] SENSe2:POWer:AC:RANGe <numeric_value>	391
Syntax	391

Example	391
Reset Condition	391
Query	391
Query Example	392
Error Messages	392
[SENSe[1]] SENSe2:POWer:AC:RANGe:AUTO <boolean>	393
Syntax	393
Example	393
Reset Condition	393
Query	394
Query Example	394
Error Messages	394
[SENSe[1]] SENSe2:SWEEp[1] 2 3 4 Commands	395
[SENSe[1]] SENSe2:SWEEp[1] 2 3 4:OFFSet:TIME <numeric_value>	396
Syntax	396
Parameters	396
Example	397
Reset Condition	397
Query	397
Query Example	397
Error Messages	397
[SENSe[1]] SENSe2:SWEEp[1] 2 3 4:TIME <numeric_value>	398
Syntax	398
Parameters	398
Example	398
Reset Condition	399
Query	399
Query Example	399
Error Messages	399
[SENSe[1]] SENSe2:TEMPerature?	400
Syntax	400
Parameters	400
Example	400
Reset Condition	400
Error Messages	400

[SENSe[1]] SENSe2:TRACe Commands	401
[SENSe[1]] SENSe2:TRACe:OFFSet:TIME <numeric_value>	402
Syntax	402
Parameters	402
Example	402
Reset Condition	403
Query	403
Query Example	403
Error Messages	403
[SENSe[1]] SENSe2:TRACe:TIME <numeric_value>	404
Syntax	404
Parameters	404
Example	404
Reset Condition	405
Query	405
Query Example	405
Error Messages	405
[SENSe[1]] SENSe2:TRACe:UNIT <character_data>	406
Syntax	406
Parameters	406
Example	406
Reset Condition	406
Query	407
Query Example	407
[SENSe[1]] SENSe2:V2P ATYPe DTYPe	408
Syntax	408
Example	408
Reset Condition	408
Query	408
Query Example	409
Error Messages	409
SENSe[1] 2:TRACe:LIMit:LOWer <numeric_value>	410
Syntax	410
Parameters	411

Example	411
Reset Condition	411
Query	411
Query Example	411
SENSe[1]:TRACe:LIMit:UPPer <numeric_value>	412
Syntax	412
Parameters	413
Example	413
Reset Condition	413
Query	413
Query Example	413
SENSe[1]:TRACe:X:SCALe:PDIV <numeric_value>	414
Syntax	414
Parameters	414
Example	414
Reset Condition	415
Query	415
Query Example	415
Error Messages	415
SENSe[1]:TRACe:Y:SCALe:PDIV <numeric_value>	416
Syntax	416
Parameters	416
Example	417
Reset Condition	417
Query	417
Query Example	417
Error Messages	417
<b>11 STATus Subsystem</b>	
STATus Subsystem	420
Examples	421
Status Register Set Commands	422
:CONDition?	422
Syntax	422
[:EVENT]?	423

Syntax	423
:ENABLE <NRf> <non-decimal numeric>	423
Syntax	423
Parameters	424
Query	424
:NTRansition <NRf> <non-decimal numeric>	424
Syntax	425
Parameters	425
Query	425
:PTRansition <NRf> <non-decimal numeric>	425
Syntax	426
Parameters	426
Query	426
Device Status Register Sets	427
Operation Register Sets	429
STATus:OPERation	430
Syntax	430
STATus:OPERation:CALibrating[:SUMMARY]	431
Syntax	431
STATus:OPERation:LLFail[:SUMMARY]	432
Syntax	432
STATus:OPERation:MEASuring[:SUMMARY]	433
Syntax	433
STATus:OPERation:SENSe[:SUMMARY]	434
Syntax	434
STATus:OPERation:TRIGger[:SUMMARY]	435
Syntax	435
STATus:OPERation:ULFail[:SUMMARY]	436
Syntax	436
STATus:PRESet	437
Syntax	437
Questionable Register Sets	438



STATus:QUEStionable	439
Syntax	439
STATus:QUEStionable:CALibration[:SUMMARY]	440
Syntax	440
STATus:QUEStionable:POWer[:SUMMARY]	441
Syntax	442

## 12 SYSTem Subsystem

SYSTem Subsystem	446
SYSTem:COMMunicate:LAN:AIP[:STATE] <boolean>	448
Syntax	448
Example	448
Query	448
Query Example	448
SYSTem:COMMunicate:LAN:CURREnt:ADDRESS?	449
Syntax	449
Example	449
SYSTem:COMMunicate:LAN:CURREnt:DGATeway?	450
Syntax	450
Example	450
SYSTem:COMMunicate:LAN:CURREnt:DNAMe?	451
Syntax	451
Example	451
SYSTem:COMMunicate:LAN:CURREnt:SMASK?	452
Syntax	452
Example	452
SYSTem:COMMunicate:LAN:ADDRESS <character_data>	453
Syntax	453
Parameters	453
Example	453
Query	453
Query Example	453
SYSTem:COMMunicate:LAN:DGATeway <character_data>	454

Syntax .....	454
Parameters .....	454
Example .....	454
Query .....	454
Query Example .....	454
SYSTEM:COMMunicate:LAN:DHCP[:STATe] <boolean> .....	455
Syntax .....	455
Example .....	455
Query .....	455
Query Example .....	455
SYSTEM:COMMunicate:LAN:DNAMe <character_data> .....	456
Syntax .....	456
Parameters .....	456
Example .....	456
Query .....	456
Query Example .....	456
SYSTEM:COMMunicate:LAN:HNAME <character_data> .....	457
Syntax .....	457
Parameters .....	457
Example .....	457
Query .....	457
Query Example .....	457
SYSTEM:COMMunicate:LAN:MAC? .....	458
Syntax .....	458
Example .....	458
SYSTEM:COMMunicate:LAN:REStart .....	459
Syntax .....	459
Example .....	459
SYSTEM:COMMunicate:LAN:SMASk <character_data> .....	460
Syntax .....	460
Parameters .....	460
Example .....	460
Query .....	460
Query Example .....	460

SYSTem:DISPlay:BMP	461
Syntax	461
Example	461
SYSTem:ERRor?	462
Syntax	462
Example	462
Reset Condition	462
Error Messages	462
Error Message List	463
SYSTem:HELp:HEADers?	469
Syntax	469
Example	469
SYSTem:PERSonA:MANufacturer <character_data>	470
Syntax	470
Parameters	470
Examples	470
Reset condition	470
Query	471
Query Example	471
Error Message	471
SYSTem:PERSonA:MANufacturer:DEFault	472
Syntax	472
Example	472
Query	472
Query Example	472
SYSTem:PRESet <character_data>	473
Syntax	474
Parameters	474
Example	475
Error messages	475
Preset Values	476
SYSTem:VERSion?	535
Syntax	535
Example	535

## 13 TRACe Subsystem

TRACe Subsystem	538
TRACe[1]2[:DATA]? <character_data>	540
Syntax	540
Parameters	541
Example	541
Error Messages	541
TRACe[1]2:DEfINE:DURation:REFerence<numeric_value>	542
Syntax	542
Parameters	542
Example	543
Reset condition	543
Query	543
Query Example	543
TRACe[1]2:DEfINE:TRANsition:REFerence <numeric_value>, <numeric_value>	544
Syntax	544
Parameters	544
Example	545
Reset Condition	545
Query	545
Query Example	545
TRACe[1]2:MEASurement:INSTant:REFerence? <numeric_value>	546
Syntax	546
Parameters	546
Example	547
Error Messages	547
TRACe[1]2:MEASurement:PULSe[1]... 10:DURation?	548
Algorithm	548
Syntax	548
Example	548
Error Messages	549
TRACe[1]2:MEASurement:PULSe[1]... 10:PERiod?	550
Algorithm	550

Syntax	550
Example	550
Error Messages	551
TRACe[1]2:MEASurement:PULSe[1]... 10:SEParation?	552
Algorithm	552
Syntax	552
Example	552
Error Messages	553
TRACe[1]2:MEASurement:TRANSition[1]... 10:NEGative:DURation?	554
Syntax	554
Reset Condition	554
Example	554
Error Messages	554
TRACe[1]2:MEASurement:TRANSition[1]... 10:NEGative:OCCurrence?	555
Syntax	555
Reset Condition	555
Example	555
Error Messages	555
TRACe[1]2:MEASurement:TRANSition[1]... 10:POSitive:DURation?	556
Syntax	556
Reset Condition	556
Example	556
Error Messages	556
TRACe[1]2:MEASurement:TRANSition[1]... 10:POSitive:OCCurrence?	557
Syntax	557
Reset Condition	557
Example	557
Error Messages	557
TRACe[1]2:MEASurement:REFerence? <numeric_value>	558
Algorithm	558
Syntax	558
Reset Condition	558

Example	559
Error Messages	559
TRACe[1] 2:STATe <boolean>	560
Syntax	560
Example	560
Reset Condition	560
Query	560
Query Example	561
Error Messages	561
TRACe[1] 2:UNIT <character_data>	562
Syntax	562
Parameters	562
Example	562
Reset Condition	563
Query	563
Query Example	563

## 14 TRIGger Subsystem

TRIGger Subsystem	566
ABORt[1] 2]	568
Syntax	568
Example	568
INITiate Commands	569
INITiate[1] 2:CONTinuous <boolean>	570
Syntax	570
Example	571
Reset Condition	571
Query	571
Query Example	571
INITiate[1] 2[:IMMediate]	572
Syntax	572
Example	572
Error Messages	572
INITiate:CONTinuous:ALL <boolean>	573

Syntax	573
Example	573
Reset Condition	573
Query	574
Query Example	574
INITiate:CONTInuous:SEQUence[1]2 <boolean>	575
Syntax	575
Example	575
Reset Condition	576
Query	576
Query Example	576
INITiate[:IMMediate]:ALL	577
Syntax	577
Example	577
Error Messages	577
INITiate[:IMMediate]:SEQUence[1]2	578
Syntax	578
Example	578
Error Messages	578
TRIGger Commands	579
TRIGger[1]2:DELay:AUTO <boolean>	580
Syntax	580
Example	581
Reset Condition	581
Query	581
TRIGger[1]2[:IMMediate]	582
Syntax	582
Example	582
Error Messages	582
TRIGger[1]2:SOURce BUS EXTErnal HOLD IMMediate INTernall[[1]2]	583
Syntax	583
Parameters	584
Example	584

Reset Condition	584
Query	585
Query Example	585
Error Messages	585
TRIGger[:SEQuence]:DELay <numeric_value>	586
Syntax	586
Parameters	586
Example	587
Reset Condition	587
Query	587
Query Example	587
Reset Condition	587
TRIGger[:SEQuence]:HOLDoff <numeric_value>	588
Syntax	588
Parameters	588
Example	589
Reset Condition	589
Query	589
Query Example	589
TRIGger[:SEQuence]:HYSTeresis <numeric_value>	590
Syntax	590
Parameters	590
Example	591
Reset Condition	591
Query	591
Query Example	591
TRIGger[:SEQuence]:LEVel <numeric_value>	592
Syntax	592
Parameters	592
Example	592
Reset Condition	592
Query	593
Query Example	593
TRIGger[:SEQuence]:LEVel:AUTO <boolean>	594



Syntax	594
Example	594
Reset Condition	594
Query	595
Query Example	595
TRIGger[:SEQuence]:SLOPe <character_data>	596
Syntax	596
Parameters	596
Reset Condition	596
Query	596
Query Example	596
TRIGger[:SEQuence[1]2]:COUnT <numeric_value>	597
Syntax	597
Parameters	597
Example	598
Reset Condition	598
Query	598
Query Example	598
Error Messages	598
TRIGger[:SEQuence[1]2]:DELay:AUTO <boolean>	599
Syntax	599
Example	600
Reset Condition	600
Query	600
Query Example	600
TRIGger[:SEQuence[1]2]:IMMediate	601
Syntax	601
Example	601
TRIGger[:SEQuence[1]2]:SOURce BUS EXTErnal HOLD IMMediate INTErnal[[1]2]	602
Syntax	602
Parameters	603
Example	603
Reset Condition	603

Query	604
Query Example	604
Error Messages	604
<b>15 UNIT Subsystem</b>	
UNIT Subsystem	606
UNIT[1] 2 3 4:POWer <amplitude_unit>	607
Syntax	607
Parameters	608
Example	608
Reset Condition	608
Query	608
Query Example	608
UNIT[1] 2 3 4:POWer:RATio <ratio_unit>	609
Syntax	609
Parameters	609
Example	610
Reset Condition	610
Query	610
<b>16 SERVice Subsystem</b>	
SERVice Subsystem	613
SERVice:BIST:CALibrator <boolean>	615
Syntax	615
Example	615
Query	615
Query Example	615
SERVice:BIST:CW[1] 2:LINearity	616
Syntax	616
Example	616
SERVice:BIST:CW[1] 2:LINearity:PERRor?	617
Syntax	617
Example	617
SERVice:BIST:CW[1] 2:ZSET:NUMber?	618

Syntax	618
Example	618
SERVICE:BIST:PEAK[1]:LINEarity <numeric_value>	619
Syntax	619
Parameters	619
Example	619
SERVICE:BIST:PEAK[1]:LINEarity:PERRor?	620
Syntax	620
Example	620
SERVICE:BIST:PEAK[1]:ZSET	621
Syntax	621
Example	621
SERVICE:BIST:PEAK[1]:ZSET:NUMber?	622
Syntax	622
Example	622
SERVICE:BIST:TBASe:STATe	623
Syntax	623
Example	623
SERVICE:BIST:TBASe:STATe <boolean>	624
Syntax	624
Example	624
Reset Condition	625
Query	625
Query Example	625
SERVICE:BIST:TRIGger:TEST?	626
Syntax	626
Example	626
SERVICE:CALibrator:ADJ:COUR <numeric_value>	627
Syntax	627
Parameters	627
Query	627
SERVICE:CALibrator:ADJ:FINE <numeric_value>	628
Syntax	628

Parameters	628
Query	628
SERVice:LAN:PHOSName	629
Syntax	629
Example	629
SERVice:SECure:ERASe	630
Syntax	630
Example	630
SERVice:SENSor[1]:2:CDATe?	631
Syntax	631
Example	631
Error Messages	631
SERVice:SENSor[1]:2:CPLace?	632
Syntax	632
Example	632
Error Messages	632
SERVice:SENSor[1]:2:FREQuency:MAXimum?	633
Syntax	633
Example	633
Error Messages	633
SERVice:SENSor[1]:2:FREQuency:MINimum?	634
Syntax	634
Example	634
Error Messages	634
SERVice:SENSor[1]:2:PCALfactor <cal_factor_data>	635
Syntax	635
Parameters	635
Query	635
Query Example	636
Error Messages	636
SERVice:SENSor[1]:2:POWer:AVERage:MAXimum?	637
Syntax	637
Example	637

Error Messages	637
SERvice:SENSor[1]2:POWer:PEAK:MAXimum?	638
Syntax	638
Example	638
Error Messages	638
SERvice:SENSor[1]2:POWer:USABLE:MAXimum?	639
Syntax	639
Example	639
Error Messages	639
SERvice:SENSor[1]2:POWer:USABLE:MINimum?	640
Syntax	640
Example	640
Error Messages	640
SERvice:SENSor[1]2:RADC?	641
Syntax	641
Example	641
Error Messages	641
SERvice:SENSor[1]2:SNUMber?	642
Syntax	642
Example	642
Error Messages	642
SERvice:SENSor[1]2:TNUMber?	643
Syntax	643
Example	643
Error Messages	643
SERvice:SENSor[1]2:TYPE?	644
Syntax	644
Example	644
Error Messages	644
SERvice:SNUMber <character_data>	645
Syntax	645
Parameters	645
Example	645

Query .....	645
SERvice:VERSion:PROcessor <character_data> .....	646
Syntax .....	646
Parameters .....	646
Example .....	646
Query .....	646
SERvice:VERSion:SYSTem <character_data> .....	647
Syntax .....	647
Parameters .....	647
Example .....	647
Query .....	647

## 17 IEEE 488.2 Command Reference

SCPI Compliance Information .....	652
*CLS .....	653
Syntax .....	653
*DDT <arbitrary block program data> <string program data> .....	654
Syntax .....	654
Parameters .....	654
Reset Condition .....	655
Query .....	655
Error Message .....	655
*ESE <NRf> .....	656
Syntax .....	656
Parameters .....	657
Query .....	657
*ESR? .....	658
Syntax .....	658
*IDN? .....	659
Syntax .....	659
*OPC .....	660
Syntax .....	660
Query .....	660

*OPT?	661
Syntax	661
*RCL <NRf>	662
Syntax	662
Parameters	662
Error Message	662
*RST	663
Syntax	663
*SAV <NRf>	664
Syntax	664
Parameters	664
*SRE <NRf>	665
Syntax	665
Parameters	666
Query	666
*STB?	667
Syntax	668
*TRG	669
Syntax	669
Error Message	669
*TST?	670
Syntax	670
*WAI	671
Syntax	671

THIS PAGE HAS BEEN INTENTIONALLY LEFT BLANK.



## List of Figures

Figure 1-1	Frequency dependent offset tables	78
Figure 1-2	Typical averaged readings on 8480 Series sensors	85
Figure 1-3	Averaging range hysteresis	86
Figure 1-4	Limits checking application	90
Figure 1-5	Limits checking results	91
Figure 1-6	How measurement are calculated	99
Figure 1-7	Generalized status register model	101
Figure 1-8	Typical status register bit changes	102
Figure 1-9	Hierarchical structure of SCPI	108
Figure 1-10	Format of <character_data>	111
Figure 1-11	Format of <non-decimal numeric>	113
Figure 1-12	Format of <NR1>	114
Figure 1-13	Format of <NR2>	114
Figure 1-14	Format of <NR3>	115
Figure 1-15	Format of <string>	116
Figure 2-1	Measurement display CONFigure block window	126
Figure 3-1	Measurement display CALCulate block window	186
Figure 3-2	CALCulate block	187
Figure 10-1	Example of averaged readings	350
Figure 12-1	IEEE 488.2 Arbitrary block program data format	469
Figure 12-2	A trace display of the active timeslots	524
Figure 15-1	Measurement display UNIT block window	606

THIS PAGE HAS BEEN INTENTIONALLY LEFT BLANK.

## List of Tables

Table 1-1	MEASure? and CONFigure preset states	61
Table 1-2	Possibilities of the defaulted source list parameter	66
Table 1-3	Range of values for window limits	92
Table 1-4	Model of sensor and measurement rates	95
Table 1-5	Bit definitions - Device status register	104
Table 1-6	Bit change conditions for device status register	104
Table 3-1	Measurement units	204
Table 3-2	Measurement units	206
Table 5-1	Measurement units	249
Table 5-2	Measurement units	252
Table 5-3	Measurement units	259
Table 5-4	Measurement units	262
Table 7-1	8480 Series power sensor tables	286
Table 7-2	8480 Series power sensor tables	289
Table 7-3	Frequency and Calibration/Offset factor list	305
Table 7-4	Frequency and Calibration/Offset factor list	309
Table 10-1	Measurement units	410
Table 10-2	Measurement units	412
Table 11-1	Commands and events affecting status register	420
Table 12-1	DEFault: Power meter presets	476
Table 12-2	GSM900: Power meter presets	480
Table 12-3	GSM900: Power meter presets: Window/Measurement settings	482
Table 12-4	GSM900: Power meter presets for secondary channel sensors	482
Table 12-5	EDGE: Power meter presets	484
Table 12-6	EDGE: Power meter presets: Window/Measurement settings	485
Table 12-7	EDGE: Power meter presets for secondary channel sensors	486
Table 12-8	CDMAone: Power meter presets	487
Table 12-9	CDMAone: Power meter presets: Window/Measurement settings	489

Table 12-10	CDMAone: Power meter presets for secondary channel sensors	490
Table 12-11	cdma2000: Power meter presets	491
Table 12-12	cdma2000: Power meter presets: Window/Measurement settings	492
Table 12-13	cdma2000: Power meter presets for secondary channel sensors	494
Table 12-14	W-CDMA: Power meter presets	495
Table 12-15	W-CDMA: Power meter presets: Window/Measurement settings	496
Table 12-16	W-CDMA: Power meter presets for secondary channel sensors	498
Table 12-17	BLUetooth: Power meter presets	499
Table 12-18	BLUetooth: Power meter presets: Window/Measurement settings	501
Table 12-19	BLUetooth: Power meter presets for secondary channel sensors	502
Table 12-20	MPCA: Power meter presets	502
Table 12-21	MPCA: Power meter presets: Window/Measurement settings	503
Table 12-22	MCPA: Power meter presets for secondary channel sensors	504
Table 12-23	RADAR: Power meter presets	505
Table 12-24	RADAR: Power meter presets: Window/Measurement settings	507
Table 12-25	RADAR: Power meter presets for secondary channel sensors	508
Table 12-26	802.11a and HiperLan2: Power meter presets	509
Table 12-27	802.11a and HiperLan2: Power meter presets: Window/Measurement settings	510
Table 12-28	802.11a and HiperLan2: Power meter presets for secondary channel sensors	511
Table 12-29	802.11b/g: Power meter presets	512
Table 12-30	802.11b/g: Power meter presets: Window/Measurement settings	513
Table 12-31	802.11b/g: Power meter presets for secondary channel sensors	514

Table 12-32	1xEV-DO: Power meter presets	515
Table 12-33	1xEV-DO: Power meter presets: Window/Measurement settings	516
Table 12-34	1xEV-DO: Power meter presets for secondary channel sensors	518
Table 12-35	1xEV-DV: Power meter presets	518
Table 12-36	1xEV-DV: Power meter presets: Window/Measurement settings	520
Table 12-37	1xEV-DV: Power meter presets for secondary channel sensors	521
Table 12-38	TD-SCDMA: Power meter presets	521
Table 12-39	TD-SCDMA: Power meter presets: Window/Measurement settings	523
Table 12-40	TD-SCDMA: Power meter presets: Window/Measurement settings	524
Table 12-41	NADC: Power meter presets	525
Table 12-42	NADC: Power meter presets: Window/Measurement settings	526
Table 12-43	NADC: Power meter presets for secondary channel sensors	527
Table 12-44	iDEN: Power meter presets	528
Table 12-45	iDEN: Power meter presets: Window/Measurement settings	530
Table 12-46	iDEN: Power meter presets for secondary channel sensors	531
Table 12-47	DVB: Power meter presets	532
Table 12-48	DVB: Power meter presets: Window/Measurement settings	533
Table 12-49	DVB: Power meter presets for secondary channel sensors	534
Table 17-1	*ESE Mapping	656
Table 17-2	*ESR? Mapping	658
Table 17-3	*SRE Mapping	665
Table 17-4	*STB? Mapping	667

THIS PAGE HAS BEEN INTENTIONALLY LEFT BLANK.

# 1 Power Meter Remote Operation

Introduction	56
Configuring the Remote Interface	57
Zeroing and Calibrating the P-Series Power Sensor	59
Making Measurement	61
Using Frequency Dependent Offset Tables	77
Setting the Range, Resolution and Averaging	84
Range	86
Setting Offsets	88
Setting Measurement Limits	90
Getting the Best Speed Performance	94
How Measurements are Calculated	99
Status Reporting	100
Saving and Recalling Power Meter Configurations	106
Using Device Clear to Halt Measurements	107
An Introduction to the SCPI Language	108
SCPI Compliance Information	117
Summary of Commands	119
Making Measurements on Wireless Communication Standards	120

This chapter describes the parameters that configure the power meter and helps you determine settings to optimize performance.

## Introduction

This chapter describes the parameters which configure the power meter and help you determine settings to optimize performance. It contains the following sections:

- “Configuring the Remote Interface” on page 57.
- “Zeroing and Calibrating the P-Series Power Sensor” on page 59.
- “Making Measurement” on page 61.
- “Using Frequency Dependent Offset Tables” on page 77.
- “Setting the Range, Resolution and Averaging” on page 84.
- “Setting Offsets” on page 88.
- “Setting Measurement Limits” on page 90.
- “Getting the Best Speed Performance” on page 94.
- “How Measurements are Calculated” on page 99.
- “Status Reporting” on page 100.
- “Saving and Recalling Power Meter Configurations” on page 106.
- “Using Device Clear to Halt Measurements” on page 107.
- “An Introduction to the SCPI Language” on page 108.
- “SCPI Compliance Information” on page 117.
- “Summary of Commands” on page 119.
- “Making Measurements on Wireless Communication Standards” on page 120.



## Configuring the Remote Interface

This section briefly describes how to configure the LAN remote interface.

### NOTE

For more information on configuring the remote interface connectivity, refer to the *Keysight Technologies USB/LAN/GPIB Interfaces Connectivity Guide*. If you have installed the *IO Libraries Suite*, you can access the *Connectivity Guide* via the Keysight IO Libraries Control icon. Alternatively, you can access the *Connectivity Guide* via the web at [www.keysight.com/find/connectivity](http://www.keysight.com/find/connectivity).

---

## LAN Configuration

The power meter has three LAN operating modes:

- Dynamic IP (Dynamic Host Configuration Protocol or DHCP)
- Auto IP (Local PC Control or isolated (non-site) LAN)
- Static IP (Manual mode)

These three modes can be set up from the P-Series soft front panel. For soft front panel operation, refer to the *P-Series Modular Power Meter Installation Guide*.

### Configuring the LAN Remotely

To automatically configure the LAN settings, enable DHCP operation using the **SYSTEM:COMMunicate:LAN:DHCP[:STATe]** command.

In this Dynamic IP mode the IP Address, Subnet Mask, and Default Gateway values are obtained from a DHCP server. Using this Dynamic IP mode does not require a detailed knowledge of your network configuration.

The IP Address, Subnet Mask, Default Gateway, and Host settings can be changed manually or remotely. To individually specify the LAN settings, use the following commands:

- IP Address **-SYSTEM:COMMunicate:LAN:ADDRESS**
- Subnet Mask **-SYSTEM:COMMunicate:LAN:SMASK**
- Default Gateway **-SYSTEM:COMMunicate:LAN:DGATeway**

## 1 Power Meter Remote Operation

- Domain Name -**SYSTem:COMMunicate:LAN:DNAME**
- Hostname -**SYSTem:COMMunicate:LAN:HNAME**
- Restart Networkk -**SYSTem:COMMunicate:LAN:REStArt**

The **character\_data** values for the IP address, Subnet Mask, and Default Gateway can range between 0.0.0.0 and 255.255.255.255.

### NOTE

If you configure an invalid IP Address or an IP address that is used by another device or host, an error message is generated. This error can be read by using the **SYSTem:ERRor?** command.

---

The LAN setting values are stored in non-volatile memory and are not part of the save-recall function.

### NOTE

For more information about *Keysight IO Libraries* software refer to the *Connectivity Guide*. If you have installed other I/O Software, refer to documentation that accompanies the software.

---

## Zeroing and Calibrating the P-Series Power Sensor

P-Series wideband power sensor's do not need manual calibration and zero routines performed. These are performed without removing the power sensor from the source.

### Zeroing

Zeroing adjusts the power meter's specified channel for a zero power reading.

The command **CALibration[1]|2:ZERO:AUTO [ONCE|ON|OFF|0|1]** causes the power meter to perform its zeroing routine on the specified channel when enabled. This adjusts the power meter for a zero power reading with no power supplied to the power sensor.

**1|ON** can only be used with a P-Series sensor. When **1|ON** is enabled the zero is maintained by a combination of zero *on-the-fly* for measurements and temperature compensation.

Zeroing of the power meter happens automatically:

- When a 5 °C change in temperature occurs
- When you change the power sensor
- Every 24 hours
- Prior to measuring low level signals. For example, 10 dB above the lowest specified power for your power sensor.

### Calibration

The command used to calibrate the power meter is:

**CALibration[1|2]:AUTO ONCE**

It is recommended that you zero the power meter before calibrating.

## Calibration Sequence

This feature allows you to perform a complete calibration sequence with a single query. The query is:

**CALibration[1|2][:ALL]?**

The query assumes that the power sensor is connected to the power reference oscillator. It turns the power reference oscillator on, then after calibrating, returns the power reference oscillator to the same state it was in prior to the command being received. The calibration sequence consists of:

- 1 Zeroing the power meter (**CALibration[1|2]:ZERO ONCE**)
- 2 Calibrating the power meter (**CALibration[1|2]:AUTO ONCE**)

The query enters a number into the output buffer when the sequence is complete. If the result is 0 the sequence was successful. If the result is 1 the sequence failed. Refer to “**CALibration[1]2[:ALL]?**” on page 228 for further information.

### NOTE

The **CALibration[1|2][:ALL]** command is identical to the **CALibration[1|2][:ALL]?** query except that no number is returned to indicate the outcome of the sequence. You can examine the **Questionable Status Register** or the error queue to discover if the sequence has passed or failed. Refer to “**Status Reporting**” on page 100 for further information.

---

## Making Measurement

The **MEASure?** and **CONFigure** commands provide a straight-forward method to program the power meter for measurements. You can select the measurement's expected power level, resolution and with the N8262A the measurement type (that is single channel, difference or ratio measurements) all in one command. The power meter automatically presets other measurement parameters to default values as shown in [Table 1-1](#) below.

**Table 1-1** MEASure? and CONFigure preset states

Command	MEASure? and CONFigure Setting
Trigger source ( <b>TRIGger:SOURce</b> )	Immediate
Filter ( <b>SENSe:AVERage:COUNT:AUTO</b> )	On
Filter state( <b>SENSe:AVERage:STATe</b> )	On
Trigger cycle ( <b>INITiate:CONTinuous</b> )	Off
Trigger Delay ( <b>TRIGger:DELay:AUTO</b> )	On

An alternative method to program the power meter is to use the lower level commands. The advantage of using the lower level commands over the **CONFigure** command is that they give you more precise control of the power meter. As shown in [Table 1-1](#), the **CONFigure** command presets various states in the power meter. It may be likely that you do not want to preset these states. Refer to [“Using the Lower Level Commands”](#) on page 75 for further information.

## Using MEASure?

The simplest way to program the power meter for measurements is by using the **MEASure?** query. However, this command does not offer much flexibility. When you execute the command, the power meter selects the best settings for the requested configuration and immediately performs the measurement. You cannot change any settings (other than the expected power value, resolution and with the N8262A the measurement type) before the measurement is taken. This means you cannot fine tune the measurement, for example, you cannot change the filter length. To make more flexible and accurate measurements use the **CONFIGure** command. The measurement results are sent to the output buffer. **MEASure?** is a compound command which is equivalent to an **ABORT**, followed by a **CONFigure**, followed by a **READ?**.

### MEASure? Examples

The following commands show a few examples of how to use the **MEASure?** query to make a measurement. It is advisable to read through these examples in order as they become increasingly more detailed. These examples configure the power meter for a measurement (as described in each individual example), automatically place the power meter in the “wait-for-trigger” state, internally trigger the power meter to take one reading, and then sends the reading to the output buffer.

These examples give an overview of the **MEASure?** query. For further information on the **MEASure?** commands refer to the section “**MEASure[1]|2|3|4 Commands**” on page 171.

### Example 1 - The Simplest Method

The following commands show the simplest method of making single channel (for example A or B) measurements. Using **MEAS1?** results in an upper window measurement, and **MEAS2?** in a lower window measurement. The channel associated with the window can be set using the source list parameter (see [Example 2 - Specifying the Source List Parameter](#)), or defaults as in this example (see “[Keysight N8262A](#)” on page 65).

specifies window



**MEAS1?**

**MEAS2?**

## Example 2 - Specifying the Source List Parameter

The **MEASure** command has three optional parameters, an expected power value, a resolution and a source list. These parameters must be entered in the specified order. If parameters are omitted, they default from the right. The parameter **DEFault** is used as a place holder.

The following example uses the source list parameter to specify the measurement channel as Channel A. The expected power and resolution parameters are defaulted, leaving them at their current settings. The measurement is carried out on the upper window.

specifies window
specifies channel  
↓
↓  
**MEAS1? DEF,DEF,(@1)**

The operation of the **MEAS1?** command when the source list parameter is defaulted is described in the note “[Keysight N8262A](#)” on page 65.

## Example 3 - Specifying the Expected Power Parameter

The previous example details the three optional parameters which can be used with the **MEASure?** command. The first optional parameter is used to enter an expected power value. Entering this parameter is only relevant if you are using an E-Series power sensor. The value entered determines which of the power sensor’s two ranges is used for the measurement. If the current setting of the power sensor’s range is no longer valid for the new measurement, specifying the expected power value decreases the time taken to obtain a result.

The following example uses the expected value parameter to specify a value of -50 dBm. This selects the power sensor’s lower range (refer to “[Range](#)” on page 86 for details of the range breaks). The resolution parameter is defaulted, leaving it at its current setting. The source list parameter specifies a Channel B measurement. The measurement is displayed on the lower window.

specifies window
specifies expected power value
specifies channel  
└─┬─┘
↓
└─┬─┘  
**MEAS2? -50,DEF,(@2)**

### Example 4 - Specifying the Resolution Parameter

The previous examples detailed the use of the expected value and source list parameters. The resolution parameter is used to set the resolution of the specified window. This parameter does not affect the resolution of the data, however it does affect the auto averaging setting (refer to [Figure 1-2](#)).

Since the filter length used for a channel with auto-averaging enabled is dependent on the window resolution setting, a conflict arises when a given channel is set up in both windows and the resolution settings are different. In this case, the higher resolution setting is used to determine the filter length.

The following example uses the resolution parameter to specify a resolution setting of 3. This setting represents 3 significant digits if the measurement suffix is W or %, and 0.01 dB if the suffix is dB or dBm. Refer to [Chapter 2](#), “MEASurement Commands” on page 123, for further details on the resolution parameter. The expected power and source list parameters are defaulted in the example. The expected power value remains unchanged at its current setting. The source list parameter defaults as described in the note “[Keysight N8262A](#)” on page 65. Note that as the source list parameter is the last specified parameter you do not have to specify DEF. The measurement is carried out on the upper window.

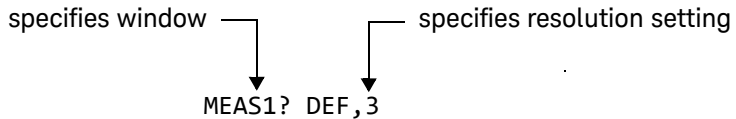

### Example 5 - Making a Difference Measurement

The following command is performed on the N8262A. It queries the lower window to make a difference measurement of Channel B -Channel A. The expected power and resolution parameters are defaulted, leaving them at their current settings.

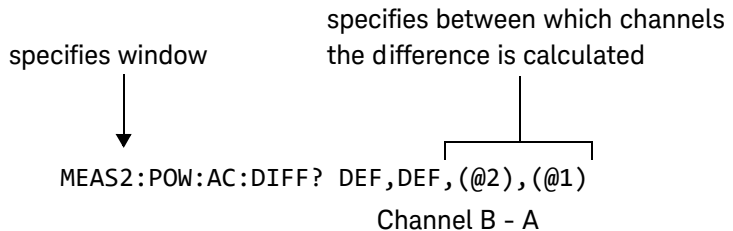



### Example 6 - Making a Ratio Measurement

The following command is performed on the N8262A. It queries the upper window to make a ratio measurement of Channel A/B. The expected power and resolution parameters are defaulted, leaving them at their current settings.

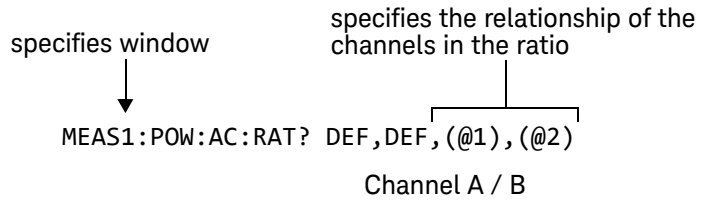

#### NOTE

#### Keysight N8262A

The operation of the MEASure? command when the source list parameter is defaulted depends on the current setup of the window concerned (for example, A, B, A/B, A-B etc.) and on the particular command used (for example, MEAS[:POW][:AC]? and MEAS:POW:AC:RAT?).

This means that when the source list parameter is defaulted, there are a number of possibilities.

**Table 1-2** Possibilities of the defaulted source list parameter

Command	Current Window Setup		Measurement
MEAS1[:POW][AC]?	Upper Window:	A	A
		B	B
		Any Other	A
MEAS2[:POW][AC]?	Lower Window:	A	A
		B	B
		Any Other	B
MEAS1:POW:AC:RAT	Upper Window:	A/B	A/B
		B/A	B/A
		Any Other	A/B
MEAS2:POW:AC:RAT	Lower Window:	A/B	A/B
		B/A	B/A
		Any Other	A/B
MEAS1:POW:AC:DIFF?	Upper Window:	A-B	A-B
		B-A	B-A
		Any Other	A-B
MEAS2:POW:AC:DIFF?	Lower Window:	A-B	A-B
		B-A	B-A
		Any Other	A-B

## Using the CONFigure Command

When you execute this command, the power meter presets the optimum settings for the requested configuration (like the **MEASure?** query). However, the measurement is not automatically started and you can change measurement parameters before making measurements. This allows you to change the power meter's configuration from the preset conditions. The power meter offers a variety of low-level commands in the **SENSe**, **CALCulate**, and **TRIGger** subsystems. For example, if you want to change the averaging use the **[SENSe[1]]|SENSe2:AVERAge:COUNT** command.

**Use the INITiate or READ? query to initiate the measurement.**

### Using READ?

**CONFigure** does not take the measurement. One method of obtaining a result is to use the **READ?** query. The **READ?** query takes the measurement using the parameters set by the **CONFigure** command then sends the reading to the output buffer. Using the **READ?** query obtains new data.

### Using INITiate and FETCh?

**CONFigure** does not take the measurement. One method of obtaining the result is to use the **INITiate** and **FETCh?** commands. The **INITiate** command causes the measurement to be taken. The **FETCh?** query retrieves a reading when the measurement is complete, and sends the reading to the output buffer. **FETCh?** can be used to display the measurement results in a number of different formats (for example, A/B and B/A) without taking fresh data for each measurement.

### CONFigure Examples

The following program segments show how to use the commands **READ?**, **INITiate** and **FETCh?** and **CONFigure** to make measurements.

It is advisable to read through these examples in order as they become increasingly more detailed.

These examples give an overview of the **CONFigure** command. For further information on the **CONFigure** commands refer to [Chapter 2, "MEASurement Commands"](#).

### Example 1 - The Simplest Method

The following program segments show the simplest method of querying the upper and lower window's measurement results respectively.

#### Using READ?

```
*RST          Reset instrument
CONF1        Configure upper window -defaults to a Channel A measurement
READ1?      Take upper window (Channel A) measurement
```

```
*RST          Reset instrument
CONF2        Configure lower window -defaults to a Channel B measurement
READ2?      Take lower window measurement (Channel B)
```

#### Using INITiate and FETCh?

```
*RST          Reset instrument
CONF1        Configure upper window -defaults to a Channel A measurement
INIT1?      Causes Channel A to make a measurement
FETC1?      Retrieves the upper window's measurement
```

```
*RST          Reset instrument
CONF2        Configure lower window
INIT2?      Causes Channel B to make a measurement
FETC2?      Retrieves the lower window's measurement
```

### Example 2 - Specifying the Source List Parameter

The **CONF**igure and **READ?** commands have three optional parameters, an expected power value, a resolution and a source list. These parameters must be entered in the specified order. If parameters are omitted, they default from the right. The parameter **DEF**ault is used as a place holder.

The following examples use the source list parameter to specify the measurement channel as Channel A. The expected power and resolution parameters are defaulted, leaving them at their current settings. The measurement is carried out on the upper window.

Although the **READ?** and **FETCh?** queries have three optional parameters it is not necessary to define them as shown in these examples. If they are defined they must be identical to those defined in the **CONFigure** command otherwise an error occurs.

### Using **READ?**

<b>ABOR1</b>	<i>Aborts Channel A</i>
<b>CONF1 DEF,DEF,(@1)</b>	<i>Configures the upper window to make a Channel A measurement using the current expected power and resolution settings</i>
<b>READ1?</b>	<i>Takes the upper window's measurement</i>

### Using **INITiate** and **FETCh?**

<b>ABOR1</b>	<i>Aborts Channel A</i>
<b>CONF1 DEF,DEF,(@1)</b>	<i>Configures the upper window to make a Channel A measurement using the current expected power and resolution settings</i>
<b>INIT1</b>	<i>Causes Channel A to make a measurement</i>
<b>FETC1? DEF,DEF,(@1)</b>	<i>Retrieves the upper window's measurement</i>

### Example 3 - Specifying the Expected Power Parameter

The previous example details the three optional parameters which can be used with the **CONFigure** and **READ?** commands. The first optional parameter is used to enter an expected power value. Entering this parameter is only relevant if you are using an E-Series power sensor. The value entered determines which of the power sensor's two ranges is used for the measurement. If the current setting of the power sensor's range is no longer valid for the new measurement, specifying the expected power value decreases the time taken to obtain a result.

The following example uses the expected value parameter to specify a value of -50 dBm. This selects the power meter's lower range (refer to "Range" on page 86 for details of the range breaks). The resolution parameter is defaulted, leaving it at its current setting. The source list parameter specifies a Channel B measurement. The measurement is carried out on the upper window.

### Using READ?

<b>ABOR2</b>	<i>Aborts Channel B</i>
<b>CONF1 -50,DEF,(@2)</b>	<i>Configures the upper window to make a Channel B measurement using an expected power of -50 dBm and the current resolution setting</i>
<b>READ1?</b>	<i>Takes the upper window's measurement</i>

Some fine tuning of measurements can be performed using the **CONF**igure and **READ**? commands. For example, in the above program segment some fine tuning can be performed by setting the filter length to 1024 and the trigger delay off.

```

1 ABOR2
2 CONF1 -50,DEF,(@2)
3 SENS2:AVER:COUN 1024
4 TRIG2:DEL:AUTO OFF
5 READ1?

```

### Using INITiate and FETCh?

<b>ABOR2</b>	<i>Aborts Channel B</i>
<b>CONF1 -50,DEF,(@2)</b>	<i>Configures the upper window to make a Channel B measurement using an expected power of -50 dBm and the current resolution setting</i>
<b>INIT2</b>	<i>Causes Channel B to make a measurement</i>
<b>FETC1? -50,DEF,(@2)</b>	<i>Retrieves the upper window's measurement</i>

Some fine tuning of measurements can be carried out using the **CONFigure** command and **INITiate** and **FETCh?** commands. For example, in the above program segment some fine tuning can be carried out by setting the filter length to 1024 and the trigger delay off.

```

1 ABOR2
2 CONF1 -50,DEF,(@2)
3 SENS2:AVER:COUN 1024
4 TRIG2:DEL:AUTO OFF
5 INIT2
6 FETC1? -50,DEF,(@2)

```

#### Example 4 - Specifying the Resolution Parameter

The previous examples detailed the use of the expected value and source list parameters. The resolution parameter is used to set the resolution of the specified window. This parameter does not affect the resolution of the data, however it does affect the auto averaging setting (refer to [Figure 1-2](#) on page 85).

Since the filter length used for a channel with auto-averaging enabled is dependent on the window resolution setting, a conflict arises when a given channel is set up in both windows and the resolution settings are different. In this case, the higher resolution setting is used to determine the filter length.

The following example uses the resolution parameter to specify a resolution setting of 3. This setting represents 3 significant digits if the measurement suffix is W or %, and 0.01 dB if the suffix is dB or dBm (for further details on the resolution parameter refer to the commands in [Chapter 2, "MEASurement Commands"](#)). Also, in this example the expected power and source list parameters are defaulted. The expected power value is left unchanged at its current setting. The source list parameter is defaulted as described in the note "[Keysight N8262A](#)" on page 65. Note that as the source list parameter is the last specified parameter you do not have to specify **DEF**.

### Using READ?

<b>ABOR1</b>	<i>Aborts Channel A</i>
<b>CONF1 DEF,3</b>	<i>Configures the upper window to make a measurement using the current setting of the expected power and source list and a resolution setting of 3</i>
<b>READ1?</b>	<i>Takes the upper window's measurement. This is Channel A or B measurement depending on current window setup.</i>

Some fine tuning of the above program segment can be carried out for example, by setting the trigger delay off. The following program segment assumes that Channel A is currently being measured on the upper window.

```
1 ABOR1
2 CONF1 DEF,3
3 TRIG1:DEL:AUTO OFF
4 READ1?
```

### Using INITiate and FETCh?

The following program segment assumes that Channel A is currently being measured on the upper window.

<b>ABOR1</b>	<i>Aborts Channel A</i>
<b>CONF1 DEF,3</b>	<i>Configures the upper window to make a measurement using the current setting of the expected power and source list and a resolution setting of 3</i>
<b>INIT1</b>	<i>Causes Channel A to make a measurement</i>
<b>FETC1? DEF,3</b>	<i>Retrieves the upper window's measurement</i>



Some fine tuning of the above program segment can be carried out for example, by setting the trigger delay off.

```

1 ABOR1
2 CONF1 DEF,3
3 TRIG1:DEL:AUTO OFF
4 INIT1:IMM
5 FETC1? DEF,3

```

### Example 5 - Making a Difference Measurement

The following program segment can be carried out on the N8262A. It queries the lower window to make a difference measurement of Channel A -Channel B. The expected power level and resolution parameters are defaulted, leaving them at their current settings. Some fine tuning of the measurement is carried out by setting the averaging, and the trigger delay to off.

#### Using READ?

```

ABOR1
ABOR2
CONF2:POW:AC:DIFF DEF,DEF,(@1),(@2)
SENS1:AVER:COUN 1024
SENS2:AVER:COUN 1024
TRIG1:DEL:AUTO OFF
TRIG2:DEL:AUTO OFF
READ2:POW:AC:DIFF?
READ2:POW:AC:DIFF? DEF,DEF,(@2),(@1) (A second READ? query is sent to make a Channel B -Channel A measurement using fresh measurement data).

```

### Using INITiate and FETCh?

```

ABOR1
ABOR2
CONF2:POW:AC:DIFF DEF,DEF,(@1),(@2)
SENS1:AVER:COUN 1024
SENS2:AVER:COUN 1024
TRIG1:DEL:AUTO OFF
TRIG2:DEL:AUTO OFF
INIT1:IMM
INIT2:IMM
FETC2:POW:AC:DIFF?
FETC2:POW:AC:DIFF? DEF,DEF,(@2),(@1) (A second FETCh? query is sent to
make a Channel B -Channel A measurement using the current measurement
data).
```

### Example 6 - Making a Ratio Measurement

The following program segment can be carried out on the N8262A. It queries the lower window to make a ratio measurement of Channel A/B. The expected power level and resolution parameters are defaulted, leaving them at their current settings. Some fine tuning of the measurement is carried out by setting the averaging.

### Using READ?

```

ABOR1
ABOR2
CONF2:POW:AC:RAT DEF,DEF,(@1),(@2)
SENS1:AVER:COUN 512
SENS2:AVER:COUN 256
READ2:POW:AC:RAT?
READ2:POW:AC:RAT? DEF,DEF,(@2),(@1) (A second READ? query is sent to make
a Channel B -Channel A ratio measurement using fresh measurement data.)
```

## Using INITiate and FETCh?

```

ABOR1
ABOR2
CONF2:POW:AC:RAT DEF,DEF,(@1),(@2)
SENS1:AVER:COUN 512
SENS2:AVER:COUN 256
INIT1:IMM
INIT2:IMM
FETC2:POW:AC:RAT?
FETC2:POW:AC:RAT? DEF,DEF,(@2),(@1) (A second FETCh? query is sent to make
a Channel B -Channel A measurement using the current measurement data.)

```

## Using the Lower Level Commands

An alternative method of making measurements is to use the lower level commands to set up the expected range and resolution. This can be done using the following commands:

```

[SENSe[1]]|SENSe2:POWER:AC:RANGE
DISPlay[:WINDow[1|2]]:RESolution

```

The measurement type can be set using the following commands in the **CALCulate** subsystem:

```

CALCulate[1|2]:MATH[:EXPRession]
CALCulate[1|2]:RELative[:MAGNitude]

```

The advantage of using the lower level commands over the **CONFigure** command is that they give you more precise control of the power meter. As shown in [Table 1-1](#) the **CONFigure** command presets various states in the power meter. It may be likely that you do not want to preset these states.

### Example

The following example sets the expected power value to -50 dBm and the resolution setting to 3 using the lower level commands. The measurement is a single Channel A measurement carried out on the lower window.

<b>ABOR1</b>	<i>Aborts Channel A</i>
<b>CALC2:MATH:EXPR "(SENS1)"</b>	<i>Displays Channel A on lower window</i>
<b>SENS1:POW:AC:RANG -50</b>	<i>Sets lower range (E-Series sensors only)</i>
<b>DISP:WIND2:RES 3</b>	<i>Sets the lower window's resolution to setting 3</i>
<b>INIT1</b>	<i>Causes Channel A to make a measurement</i>
<b>FETC2?</b>	<i>Retrieves the lower window's measurement</i>

## Using Frequency Dependent Offset Tables

This section describes how to use frequency dependent offset tables. These tables give you the ability to compensate for frequency effects in your test setup.

### Overview

If the `[SENSe[1]]|SENSe2:CORRection:CSET2:STATe` command is **OFF**, the frequency dependent offset tables are not used. When `[SENSe[1]]|SENSe2:CORRection:CSET2:STATe` is **ON**, the frequency dependent offset tables are used, providing you with a quick and convenient method of compensating for your external test setup over a range of frequencies. Note that when selected, frequency dependent offset correction is **IN ADDITION** to any correction applied for sensor frequency response. The power meter is capable of storing 10 frequency dependent offset tables of 80 frequency points each.

To use frequency dependent offset tables you:

- 1** Edit a frequency dependent offset table if necessary.
- 2** Select the frequency dependent offset table.
- 3** Enable the frequency dependent offset table.
- 4** Zero and calibrate the power meter.

If you are using an 8480 Series sensor the reference calibration factor used during the calibration must be entered manually.

- 5** Specify the frequency of the signal you want to measure. The required offset is automatically set by the power meter from the frequency dependent offset table.
- 6** Make the measurement.

**Figure 1-1** Illustrates how frequency dependent offset tables operate.

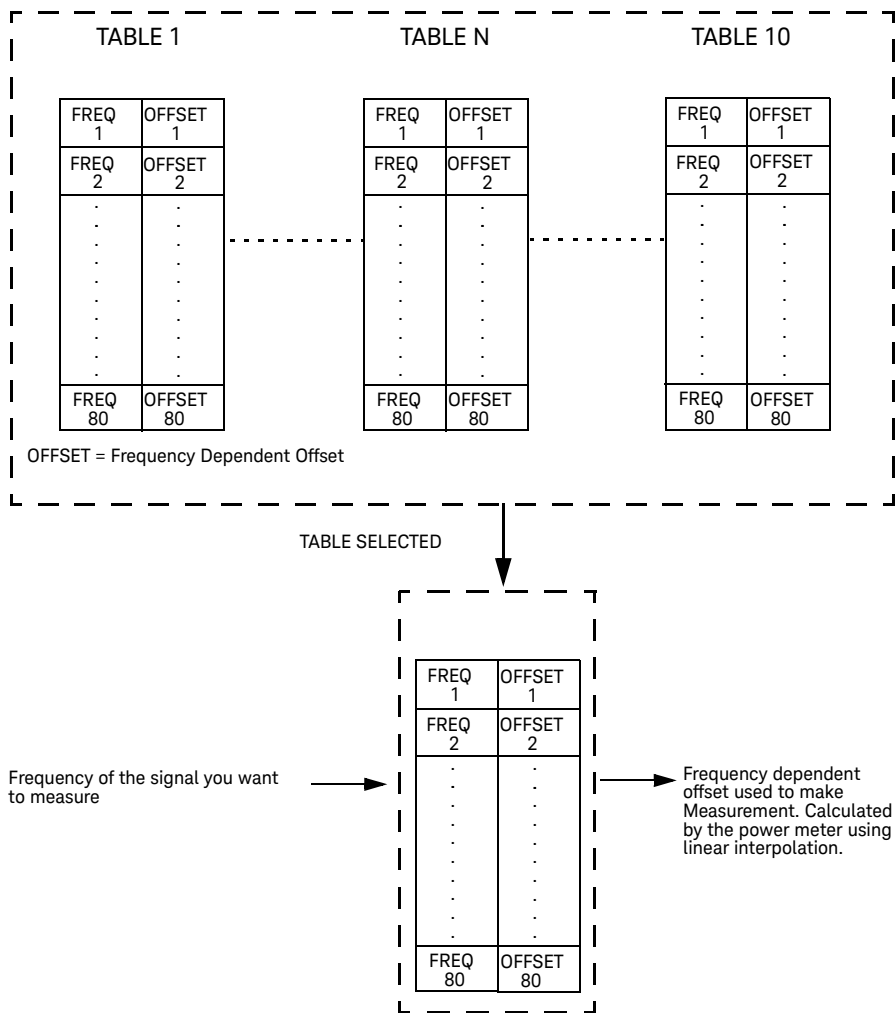

**Figure 1-1** Frequency dependent offset tables

## Editing Frequency Dependent Offset Tables

It is not possible to create any additional frequency dependent offset tables. However, the 10 existing tables can be edited using the **MEMory** subsystem. To do this:

- 1 Select one of the existing tables using:  
**MEMory:TABLE:SElect** <string>  
 For information on naming frequency dependent offset tables see [“Naming Frequency Dependent Offset Tables”](#) on page 81. For information on the current names which you can select refer to [“Listing the Frequency Dependent Offset Table Names”](#) on page 80.
- 2 Enter the frequency data using:  
**MEMory:TABLE:FREQuency** <numeric\_value> {,<numeric\_value>}
- 3 Enter the offset factors as shown in the table below using:  
**MEMory:TABLE:GAIN** <numeric\_value> {,<numeric\_value>}

Frequency	Offset
Frequency 1	Offset 1
Frequency 2	Offset 2
"	"
Frequency n	Offset n

- 4 If required, rename the frequency dependent offset table using:  
**MEMory:TABLE:MOVE** <string>,<string>. The first <string> parameter identifies the existing table name, and the second identifies the new table name.

**NOTE**

The legal frequency suffix multipliers are any of the IEEE suffix multipliers, for example, KHZ, MHZ, and GHZ. If no units are specified the power meter assumes the data is Hz.

PCT is the only legal unit for offset factors and can be omitted.

The frequency and offset data must be within range. Refer to the individual commands in [Chapter 4](#) for their specified ranges.

Any offset values entered into the table should exclude the effect of the sensor. Characterization of the test setup independently of the sensor allows the same table to be used with any sensor.

Ensure that the frequency points you use cover the frequency range of the signals you want to measure. If you measure a signal with a frequency outside the frequency range defined in the frequency dependent offset table, then the power meter uses the highest or lowest frequency point in the table to calculate the offset.

To make subsequent editing of a frequency dependent offset table simpler, it is recommended that you retain a copy of your data in a program.

### Listing the Frequency Dependent Offset Table Names

To list the frequency dependent offset tables currently stored in the power meter, use the following command:

**MEMory:CATalog:TABLE?**

Note that all tables are listed; including sensor calibration tables.

The power meter returns the data in the form of two numeric parameters and a string list representing all stored tables.

- `<numeric_value>,<numeric_value>{,<string>}`  
The first numeric parameter indicates the amount of memory, in bytes, used for storage of tables. The second parameter indicates the memory, in bytes, available for tables.

Each string parameter returned indicates the name, type and size of a stored frequency dependent offset table:



- `<string>,<type>,<size>`  
The `<string>`, `<type>` and `<size>` are all character data. The `<type>` is always `TABL`. The `<size>` is displayed in bytes.

For example, a sample of the response may look like:

```
560,8020,"Offset_1,TABL,220","Offset_2,TABL,340" . . . .
```

## Naming Frequency Dependent Offset Tables

To rename a frequency dependent offset table use:

```
MEMory:TABLE:MOVE <string>,<string>
```

The first `<string>` parameter identifies the existing table name, and the second identifies the new table name.

The following rules apply to frequency dependent offset table names:

- 1 Table names use a maximum of 12 characters.
- 2 All characters must be upper or lower case alphabetic characters, or numeric (0-9), or an underscore (`_`).

No spaces are allowed in the name.

## Reviewing Table Data

To review the data stored in a frequency dependent offset table, use the following commands:

```
MEMory:TABLE:SElect "Offset1"
```

*Select the sensor calibration table named "Offset1".*

```
MEMory:TABLE:SElect?
```

*Query command which returns the name of the currently selected table.*

```
MEMory:TABLE:FREquency:POINTs?
```

*Query command which returns the number of stored frequency points.*

```
MEMory:TABLE:FREquency?
```

*Query command which returns the frequencies stored in the frequency dependent offset table (in Hz).*

```
MEMory:TABLE:GAIN[:MAGNitude]:POINTs?
```

*Query command which returns the number of offset factor points stored in the frequency dependent offset table.*

```
MEMory:TABLE:GAIN[:MAGNitude]?
```

*Query command which returns the offset factors stored in the frequency dependent offset table.*

## Modifying Data

If you need to modify the frequency and offset factor data stored in a frequency dependent offset table you need to resend the complete data lists.

If you have retained the original data in a program, edit the program and resend the data.

## Selecting a Frequency Dependent Offset Table

After you have created the frequency dependent offset table, you can select it using the following command:

```
[SENSe[1]]|SENSe2:CORRection:CSET2[:SElect] <string>
```

To find out which frequency dependent offset table is currently selected, use the query:

```
[SENSe[1]]|SENSe2:CORRection:CSET2[:SElect]?
```

## Enabling a Frequency Dependent Offset Table

To enable the frequency dependent offset table, use the following command:

```
[SENSe[1]]|SENSe2:CORRection:CSET2:STATe ON
```

If you set `[SENSe[1]]|SENSe2:CORRection:CSET2:STATe` to **ON** and no frequency dependent offset table is selected error -221, "Settings conflict" occurs.

## Making the Measurement

To make the power measurement, set the power meter for the frequency of the signal you want to measure. The power meter automatically sets the calibration factor. Use either the **INITiate**, **FETCH?** or the **READ?** query to initiate the measurement as shown in the following program segments:

### INITiate Example

```
ABORt1
CONFigure1:POWer:AC DEF,1,(@1)
SENS1:CORR:CSET2:SEL "Offset1"
SENS1:CORR:CSET2:STAT ON
```

```
SENSe1:FREQuency 500KHZ
INITiate1:IMMediate
FETCh1?
```

### READ? Example

```
ABORt1
CONFIgure1:POWer:AC DEF,2,(@1)
SENS1:CORR:CSET2:SEL "Offset1"
SENS1:CORR:CSET2:STAT ON
SENSe1:FREQuency 500KHZ
READ1?
```

#### NOTE

If the measurement frequency does not correspond directly to a frequency in the frequency dependent offset table, the power meter calculates the offset using linear interpolation.

If you enter a frequency outside the frequency range defined in the frequency dependent offset table, then the power meter uses the highest or lowest frequency point in the table to set the offset.

To find out the value of the offset being used by the power meter to make a measurement, use the query command:

```
SENSe:CORRection:GAIN4|FDOFfset[:INPut][MAGNITUDE]?
```

The response may be an interpolated value.

## Setting the Range, Resolution and Averaging

This section provides an overview of setting the range, resolution and averaging. For more detailed information about these features, refer to the individual commands in [Chapter 10, "SENSe Subsystem"](#).

### Resolution

You can set the window's resolution using the following command:

```
DISPlay[:WINDow[1]|2][:NUMeric[1]|2]
:RESolution <numeric_value>
```

There are four levels of resolution available (1 through 4).

When the measurement suffix is W or % this parameter represents the number of significant digits. When the measurement suffix is dB or dBm, 1 through 4 represents 1, 0.1, 0.01, and 0.001 dB respectively.

Refer to the **:RESolution** command on [page 265](#) for further information.

### Averaging

The power meter has a digital filter to average power readings. The number of readings averaged can range from 1 to 1024. This filter is used to reduce noise, obtain the desired resolution and to reduce the jitter in the measurement results. However, the time to take the measurement is increased. You can select the filter length or you can set the power meter to auto filter mode. To enable and disable averaging use the following command:

```
[SENSe[1]]|SENSe2:AVERage[:STATE] <boolean>
```

## Auto Averaging Mode

To enable and disable auto filter mode, use the following command:

```
[SENSe[1]]|SENSe2:AVERAge:COUNT:AUTO <boolean>
```

When the auto filter mode is enabled, the power meter automatically sets the number of readings averaged together to satisfy the filtering requirements for most power measurements. The number of readings averaged together depends on the resolution and the power level currently being measured. Figure 1-2 lists the number of readings averaged for each range and resolution when the power meter is in auto filter mode.

### NOTE

Figure 1-2 applies to 8480 Series sensors only.

Power Sensor Dynamic Range	Minimum Sensor Power	Resolution Setting				Number of Averages
		1	2	3	4	
10 dB 10 dB 10 dB 10 dB	8	8	128	128	8 16 32 256	
	1	1	16	256		
	1	1	2	32		
	1	1	1	16		
	1	1	1	8		
	Maximum Sensor Power					

Figure 1-2 Typical averaged readings on 8480 Series sensors

Figure 1-3 Illustrates part of the power sensor dynamic range hysteresis.

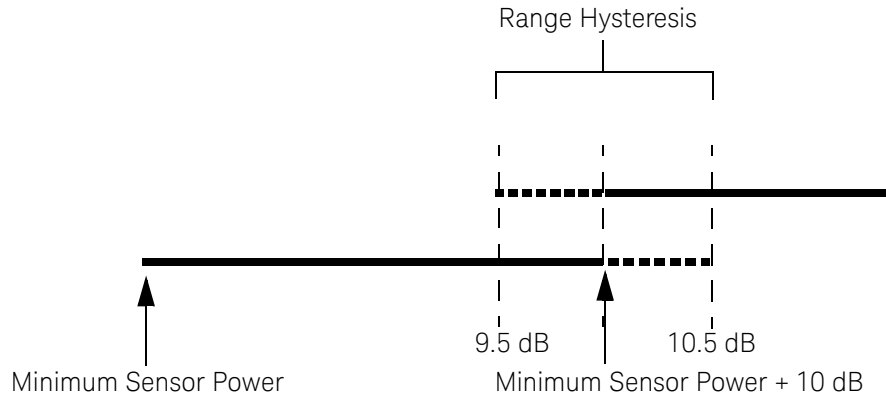

**Figure 1-3** Averaging range hysteresis

## Filter Length

You specify the filter length using the following command:

```
[SENSe[1]]|SENSe2:AVERage:COUNT <numeric_value>
```

The range of values for the filter length is 1 to 1024. Specifying this command disables automatic filter length selection. Increasing the value of the filter length reduces measurement noise. However, the time to take the measurement is increased.

## Range

The power meter has no internal ranges which can be set. The only ranges that can be set are those of the E-Series power sensor. With an E-Series power sensor the range can be set either automatically or manually. Use autoranging when you are not sure of the power level you will be measuring.

## Setting the Range

To set the range manually use the following command:

```
[SENSe[1]]|SENSe2:POWer:AC:RANGe <numeric_value>
```

If the <numeric\_value> is set to:

- 0, the sensor's lower range is selected. (For example, this range is -70 to -13.5 dBm for the E4412A power sensor.)
- 1, the sensor's upper range is selected. (For example, this range is -14.5 to +20 dBm for the E4412A power sensor.)

For details on the range limits of other E-Series power sensor refer to the appropriate power sensor manual.

For further information on this command refer to [page 391](#).

To enable autoranging use the following command:

```
[SENSe[1]]|SENSe2:POWer:AC:RANGe:AUTO ON
```

Use autoranging when you are not sure of the power level you will be measuring.

## Setting Offsets

### Channel Offsets

The power meter can be configured to compensate for signal loss or gain in your test setup (for example, to compensate for the loss of a 10 dB attenuator). You use the **SENSe** command subsystem to configure the power meter. Gain and loss correction are a coupled system. This means that a gain set by `[SENSe[1]]|SENSe2:CORRection:GAIN2` is represented in the `[SENSe[1]]|SENSe2:CORRection:LOSS2?` command. If you enter an offset value the state is automatically enabled. However it can be enabled and disabled using either the `[SENSe[1]]|SENSe2:CORRection:GAIN2:STATe` or `[SENSe[1]]|SENSe2:CORRection:LOSS2:STATe` commands.

**LOSS2** is coupled to **GAIN2** by the equation  $Loss = \frac{1}{Gain}$  when the default unit is linear, and  $Gain = -Loss$  when the default is logarithmic.

#### NOTE

You can only use **LOSS2** and **GAIN2** for external losses and gains. **LOSS1** and **GAIN1** are specifically for calibration factors.

### Display Offsets

Display offset values can be entered using the `CALCulate[1|2]:GAIN[:MAGNitude]` command. `CALCulate[1|2]:GAIN:STATe` must be set to **ON** to enable the offset value. If you enter an offset value the state is automatically enabled. This offset is applied after any math calculations (refer to [Figure 1-6](#) on page 99).

#### Example

The following example program, in HP Basic, details how to use the channel and display offsets on an N8262A making a Channel A/B ratio measurement.

The final result is:



$$\left( \left( \frac{A_{dBm} - 10}{B_{dBm} - 10} \right) - 20 \right)_{dB}$$

```

10 !Create I/O path name
20 ASSIGN @POWER TO 713
30 !Clear the power meter's interface
40 CLEAR @POWER
50 !Set the power meter to a known state
60 OUTPUT @POWER;"*RST"
70 !Configure the Power Meter to make the measurement
80 OUTPUT @Power;"CONF:POW:AC:RAT 20DBM,2,(@1),(@2)"
90 !Set the measurement units to dBm
100 OUTPUT @POWER;"UNIT:POW DBM"
110 !Set the power meter for channel offsets of -10 dB
120 OUTPUT @POWER;"SENS1:CORR:GAIN2 -10"
130 OUTPUT @POWER;"SENS2:CORR:GAIN2 -10"
140 !Enable the gain correction
150 OUTPUT @POWER;"SENS:CORR:GAIN2:STATE ON"
160 OUTPUT @POWER;"SENS2:CORR:GAIN2:STATE ON"
170 !Set the power meter for a display offset of -20 dB
180 OUTPUT @POWER;"CALC1:GAIN -20 DB"
190 PRINT "MAKING THE MEASUREMENT"
200 !Initiate the measurement
210 OUTPUT @Power;"INIT1:IMM"
220 OUTPUT @Power;"INIT2:IMM"
230 ! ... and get the result
240 OUTPUT @Power;"FETC:POW:AC:RAT? 20DBM,2,(@1),(@2)"
250 ENTER @Power;Reading
260 !
270 PRINT "The measurement result is ";Reading;"dB."
280 END

```

For further information on channel offsets refer to [page 379](#). For further information on display offsets refer to [page 192](#).

## Setting Measurement Limits

You can configure the power meter to detect when a measurement is outside of a predefined upper and/or lower limit value.

Limits are window or measurement display line based and can be applied to power, ratio or difference measurements.

### Setting Limits

The power meter can be configured to verify the power being measured against an upper and/or lower limit value. The range of values that can be set for lower and upper limits is  $-150.00$  dBm to  $+230.00$  dBm. The default upper limit is  $+90.00$  dBm and the default lower limit is  $-90.00$  dBm.

A typical application for this feature is shown in [Figure 1-4](#).

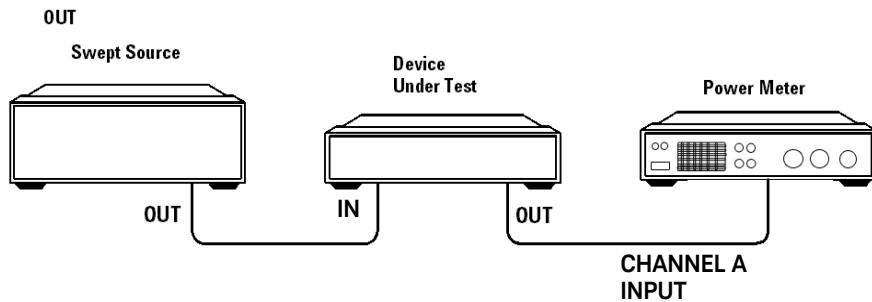

**Figure 1-4** Limits checking application

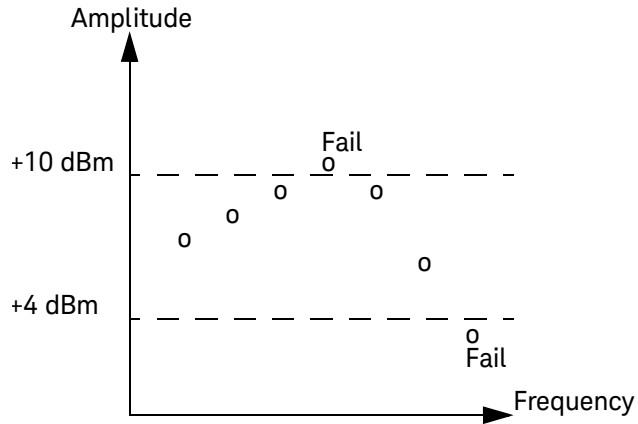

**Figure 1-5** Limits checking results

The range of values that can be set for the upper and lower limits and the default values depends on the measurement units in the currently measurement line - see [Table 1-3](#).

**Table 1-3** Range of values for window limits

Window Units	Default			
	Maximum	Minimum	Maximum	Minimum
dB	+200 dB	-180 dB	60 dB	-120 dB
dBm	+230 dBm	-150 dBm	90 dBm	-90 dBm
%	999.9 X%	100.0 a%	100.0 M%	100.0 p%
W	100.000 XW	1.000 aW	1.000 MW	1.000 pW

## Checking for Limit Failures

There are two ways to check for limit failures:

- 1 Use the **SENSe:LIMit:FAIL?** and **SENSe:LIMit:FCOunt?** commands for channel limits or the **CALCuLate[1|2]:LIMit:FAIL?** and the **CALCuLate[1|2]:LIMit:FCOunt?** for window limits
- 2 Use the **STATus** command subsystem

### Using SENSe and CALCulate

Using **SENSe** to check the channel limit failures in [Figure 1-5](#) would return the following results:

**SENSe:LIMit:FAIL?**

*Returns 1 if there has been 1 or more limit failures or 0 if there have been no limit failures. In this case 1 is returned.*

**SENSe:LIMit:FCOunt?**

*Returns the total number of limit failures, in this case 2.*

Use the equivalent **CALCuLate** commands for checking window limit failures.

**NOTE**

If `TRIGger:DElay:AUTO` is set to `ON`, then the number of failures returned by `SENSe:LIMit:FCOunt?` or `CALCuLate[1|2]:LIMit:FCOunt?` is affected by the current filter settings.

---

## Using STATus

You can use the **STATus** subsystem to generate an **SRQ** to interrupt your program when a limit failure occurs. This is a more efficient method than using **SENSe** or **CALCuLate**, since you do not need to check the limit failures after every power measurement.

Refer to “[Status Reporting](#)” on page 100 and “[STATus Subsystem](#)” on page 419 for further information.

## Getting the Best Speed Performance

This section discusses the factors that influence the speed of operation (number of readings/sec) of a P-Series modular power meter.

The following factors are those which have the greatest effect upon measurement speed (in no particular order):

- The selected measurement rate, i.e. **NORMa1**, **DOUBLe**, **FAST**.
- The sensor being used.
- The trigger mode (for example, free run, trigger with delay etc.).
- The output format: **ASCIi** or **REAL**.
- The units used for the measurement.
- The command used to take a measurement.

In addition, in **FAST** mode there are other influences which are described in “**Fast Mode**” on page 98.

The following paragraphs give a brief description of the above factors and how they are controlled from SCPI.

### Measurement Rate

There are three possible speed settings **NORMa1**, **DOUBLe** and **FAST**. These are set using the **SENSe:MRATe** command and can be applied to each channel independently.

In **NORMa1** and **DOUBLe** modes, full instrument functionality is available and these settings can be used with all sensors. **FAST** mode is only available for the P-Series and E-Series sensors. Also, in **FAST** mode averaging, limits and ratio/difference math functions are disabled.

Refer to “Specifications” in the *P-Series Modular Power Meter User’s Guide* to see the influence of these speed settings on the accuracy and noise performance of the power meter.

## Sensor

Different measurement rates are achievable depending on the sensor type being used, as shown in [Table 1-4](#):

**Table 1-4** Model of sensor and measurement rates

Sensor	Measurement Rate		
	NORMAL	DOUBLE	FAST
8480 Series	20 reading/s	40 reading/s	NA
E-Series E4410 and E9300	50 ms	25 ms	Up to 400
	20 reading/s	40 reading/s	
P-Series	50 ms	25 ms	Up to 1500
	20 reading/s	40 reading/s	

## Trigger Mode

The power meter has a very flexible triggering system. For simplicity, it can be described as having three modes:

- Free Run: When a channel is in Free Run, it continuously takes measurements on this channel. A channel is in free run when **INITiate:CONTinuous** is set to **ON** and **TRIGger:SOURce** is set to **IMMediate**.
- Triggered Free Run: When a channel is in Triggered Free Run Continuous Trigger, it takes a new measurement each time a trigger event is detected. A channel is in Triggered Free Run Continuous Trigger when **INITiate:CONTinuous** is set to **ON** and **TRIGger:SOURce** is not set to **IMMediate**.
- Single Shot: When a channel is in Single Shot, it takes a new measurement when a trigger event is detected and then returns to the idle state. A channel is in Single Shot when **INITiate:CONTinuous** is set to **OFF**. Note that a measurement can take several INT/EXT triggers depending on the filter settings. Refer to “**TRIGger[1]2:DElay:AUTO <boolean>**” on page 580 for further information.

**NOTE**

A trigger event can be any of the following:

- The input signal meeting the trigger level criteria.
  - Auto-level triggering being used.
  - A TRIGger GET or \*TRG command being sent.
  - An external TTL level trigger being detected.
- 

### Trigger with Delay

This can be achieved using the same sequences above (apart from the second) with **TRIG:DEL:AUTO** set to **ON**. Also, the **MEAS?** command operates in trigger with delay mode.

In trigger with delay mode, a measurement is not completed until the power meter filter is full. In this way, the reading returned is guaranteed to be settled. In all other modes, the result returned is simply the current result from the filter and may or may not be settled. This depends on the current length of the filter and the number of readings that have been taken since a change in power level.

With trigger with delay enabled, the measurement speed can be calculated roughly using the following equation:

$$\text{readings/sec} = \text{speed (as set by SENSE:SPEd)}/\text{filter length}$$

For example, with a filter length of 4 and **SENS:SPE** set to **20**, approximately 5 readings/sec is calculated by the power meter.

Typically, free run mode provides the best speed performance from the power meter (especially in 200 readings/sec mode).



## Output Format

The power meter has two output formats for measurement results: **AScii** and **REAL**. These formats are selected using the **FORMat** command. When **FORMat** is set to **REAL**, the returned result is in IEEE 754 floating-point format (note that the byte order can be changed using **FORMat:BORDER**) plus <LF> as an end sentinel of the block.

The **REAL** format is likely to be required only for **FAST** mode as it reduces the amount of bus traffic.

## Units

The power meter can output results in either linear or log units. The internal units are linear, therefore optimal performance is achieved when the results output are also in linear units (since the overhead of performing a log function is removed).

## Command Used

In Free Run mode, **FETCh?** must be used to return a result.

In other trigger modes, there are a number of commands which can be used, for example, **MEASure?**, **READ?**, **FETCh?** Note that the **MEAS?** and **READ?** commands are compound commands—they perform a combination of other lower level commands. Typically, the best speed performance is achieved using the low level commands directly.

## Trigger Count

To get the fastest measurement speed the a **TRIG:COUNT** must be set to return multiple measurements for each **FETCh** command. For average only measurements a count of 4 is required, however, 10 is recommended. In normal mode (peak measurements) a count of 50 is required to attain 1000 readings per second.

## Fast Mode

In the highest speed setting, the limiting factor tends to be the speed of the controller being used to retrieve results from the power meter, and to a certain extent, the volume of remote traffic. The latter can be reduced using the **FORMat REAL** command to return results in binary format. The former is a combination of two factors:

- the hardware platform being used
- the programming environment being used

## How Measurements are Calculated

Figure 1-6 details how measurements are calculated. It shows the order in which the various power meter functions are implemented in the measurement calculation.

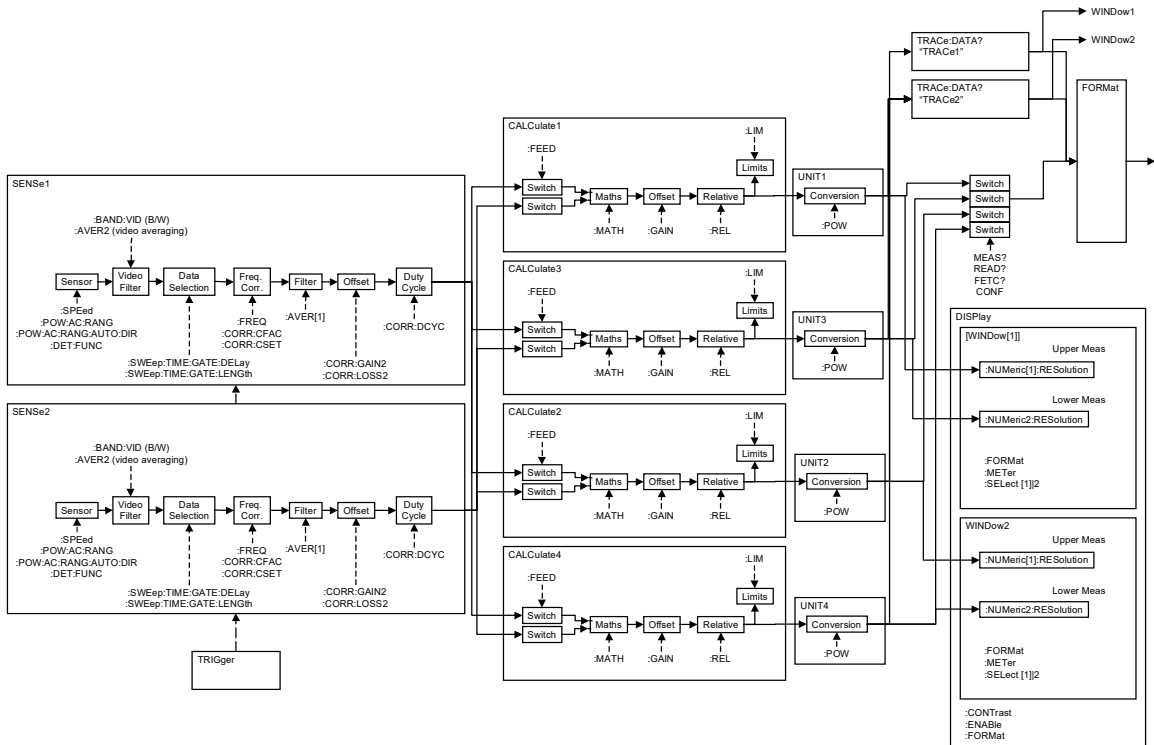

**Figure 1-6** How measurement are calculated

The MEASure commands in this figure can be replaced with the FETCH? and READ? commands.

## Status Reporting

Status reporting is used to monitor the power meter to determine when events have occurred. Status reporting is accomplished by configuring and reading status registers.

The power meter has the following main registers:

- Status Register
- Standard Event Register
- Operation Status Register
- Questionable Status Register
- Device Status Register

There are other registers that exist “behind” the main registers, and are described later in this chapter.

Status and Standard Event registers are read using the IEEE-488.2 common commands.

Operation and Questionable Status registers are read using the SCPI **STATus** command subsystem.

### The General Status Register Model

The generalized status register model shown in [Figure 1-7](#) is the building block of the SCPI status system. This model consists of a condition register, a transition filter, an event register and an enable register. A set of these registers is called a status group.

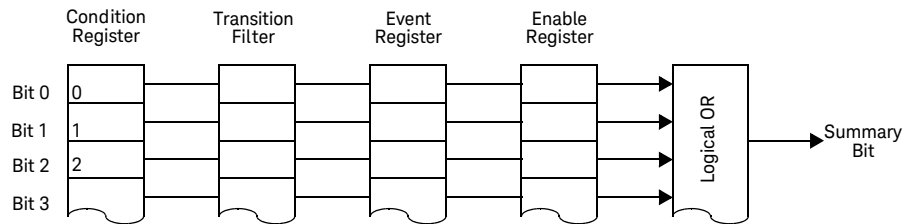

**Figure 1-7** Generalized status register model

When a status group is implemented in an instrument, it always contains all of the component registers. However, there is not always a corresponding command to read or write to every register.

### Condition Register

The condition register continuously monitors the hardware and firmware status of the power meter. There is no latching or buffering for this register, it is updated in real time. Condition registers are read-only.

### Transition Filter

The transition filter specifies which types of bit state changes in the condition registers and set corresponding bits in the event register. Transition filter bits may be set for positive transitions (PTR), negative transitions (NTR), or both. Transition filters are read-write. They are unaffected by **\*CLS** or queries. After **STATUS:PRESet** the NTR register is set to **0** and all bits of the PTR are set to **1**.

### Event Register

The event register latches transition events from the condition register as specified by the transition filter. Bits in the event register are latched and on setting they remain set until cleared by a query or a **\*CLS**. Also on setting, an event bit is no longer affected by condition changes. It remains set until the event register is cleared; either when you read the register or when you send the **\*CLS** (clear status) command. Event registers are read-only.

### Enable Register

The enable register specifies the bits in the event register that can generate a summary bit. The instrument logically ANDs corresponding bits in the event and enable registers and ORs all the resulting bits to obtain a summary bit. Enable registers are read-write. Querying an enable register does not affect it.

### An Example Sequence

Figure 1-8 illustrates the response of a single bit position in a typical status group for various settings. The changing state of the condition in question is shown at the bottom of the figure. A small binary table shows the state of the chosen bit in each status register at the selected times T1 to T5.

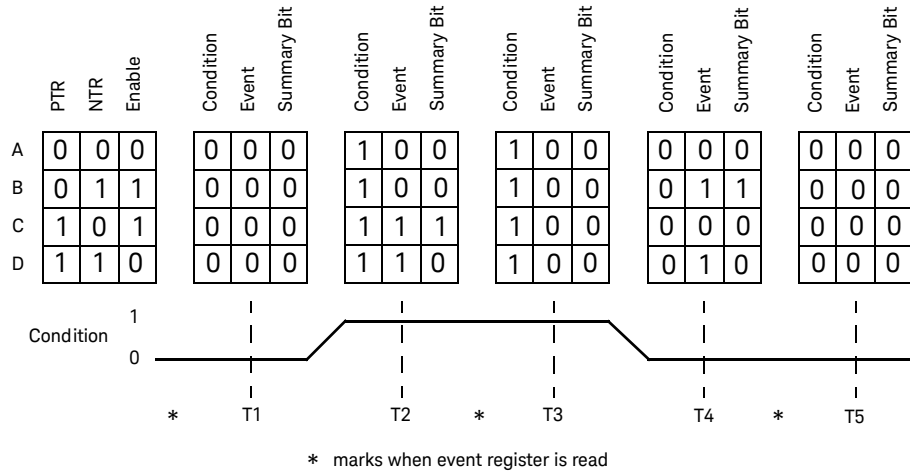

**Figure 1-8** Typical status register bit changes

## How to Use Register

The polling method is used to access the information in status groups when:

- your language/development environment does not support SRQ interrupts.
- you want to write a simple, single purpose program and do not want to add the complexity of setting an SRQ handler.

## The Condition Polling Method

In this polling method, the power meter has a passive role. It only informs the controller that conditions have changed when the controller asks. When you monitor a condition with the polling method, you must:

- 1** Determine which register contains the bit that monitors the condition.
- 2** Send the unique query that reads that register.
- 3** Examine the bit to see if the condition has changed.

The polling method works well if you do not need to know about the changes the moment they occur. The SRQ method is more effective if you must know immediately when a condition changes. Detecting an immediate change in a condition using the polling method requires your program to continuously read the registers at very short intervals. This is not particularly efficient and there is a possibility that an event may be missed.

## Device Status Register

The device status register set contains bits which give device dependent information.

The following bits in these registers are used by the power meter:

**Table 1-5** Bit definitions - Device status register

Bit Number	Decimal Weight	Definition
0	-	Not used
1	2	Channel A sensor connected
2	4	Channel B sensor connected
3	8	Channel A sensor error
4	16	Channel B sensor error
14	16384	Soft Front Panel button click

The condition bits are set and cleared under the following conditions:

**Table 1-6** Bit change conditions for device status register

Bit Number	Meaning	EVENTs Causing Bit Changes
1	Channel A sensor connected	<ul style="list-style-type: none"> <li>- <b>SET:</b> When a power sensor is connected to the Channel A input.</li> <li>- <b>CLEARED:</b> When no power sensor is connected to the Channel A input.</li> </ul>
2	Channel B sensor connected	<ul style="list-style-type: none"> <li>- <b>SET:</b> When a power sensor is connected to the Channel B input.</li> <li>- <b>CLEARED:</b> When no power sensor is connected to the Channel B input.</li> </ul>
3	Channel A error	<ul style="list-style-type: none"> <li>- <b>SET:</b> If the power sensor EEPROM on Channel A has failed.</li> <li>- <b>CLEARED:</b> In every other condition.</li> </ul>
4	Channel B error	<ul style="list-style-type: none"> <li>- <b>SET:</b> If the power sensor EEPROM on Channel B has failed.</li> <li>- <b>CLEARED:</b> In every other condition.</li> </ul>
14	Soft Front Panel button click	This is an event, and DOES NOT set the condition register. The bit is set in the event register which is cleared when read. Note that the transition registers are of no use for this bit.



## Using the Operation Complete Commands

The **\*OPC?** and **\*OPC** commands allow you to maintain synchronization between the computer and the power meter. The **\*OPC?** query command places an ASCII character 1 into the power meter's output queue when all pending power meter commands are complete. If your program reads this response before continuing program execution, you can ensure synchronization between one or more instruments and the computer.

The **\*OPC** command sets bit 0 (Operation Complete) in the Standard Event Status Register when all pending power meter operations are complete.

### Procedure

- Send a device clear message to clear the power meter's output buffer.
- Clear the event registers with the **\*CLS** (clear status) command.
- Enable operation complete using the **\*ESE 1** command (standard event register).
- Send the **\*OPC?** (operation complete query) command and enter the result to assure synchronization.
- Send your programming command string, and place the **\*OPC** (operation complete) command as the last command.
- Send the **\*STB?** (status byte query) command to poll the register. This command does not clear the status byte summary register.

### Examples

This example program uses the **\*OPC?** command to determine when the power meter has finished calibrating.

```
CAL:AUTO ONCE
*OPC?
MEAS:POW:AC?
```

## Saving and Recalling Power Meter Configurations

To reduce repeated programming, up to ten power meter configurations can be stored in the power meter's non-volatile memory. The error list, remote addresses, sensor calibration table data, zeroing and calibration information are not stored.

### How to Save and Recall a Configuration

Power meter configurations are saved and recalled with the following commands:

```
*SAV <NRf>
*RCL <NRf>
```

The range of values for <NRf> in the above commands is 1 to 10.

#### Example Program

```
10 ASSIGN @POWER TO 713
20 !Configure the power meter
30 OUTPUT @POWER;"UNIT:POW W"
40 OUTPUT @POWER;"SENS:CORR:LOSS2 -10"
50 OUTPUT @POWER;"SENS:CORR:LOSS2:STAT ON"
60 !Save the configuration
70 OUTPUT @POWER;"*SAV 5"
80 PRINT "Configuration Saved"
90 !Now reset the power meter
100 OUTPUT @POWER;"*RST"
110 ! Recall the configuration
120 OUTPUT @POWER;"*RCL 5"
130 PRINT "Configuration Recalled"
140 PRINT "Save and Recall complete"
150 END
```

## Using Device Clear to Halt Measurements

Device clear is an IEEE-488 low-level bus message which can be used to halt measurements in progress. Different programming languages and IEEE-488 interface cards provide access to this capability through their own unique commands. The status registers, the error queue, and all configuration states are left unchanged when a device clear message is received. Device clear performs the following actions.

- All measurements in progress are aborted.
- The power meter returns to the trigger “idle state”.
- The power meter’s input and output buffers are cleared.
- The power meter is prepared to accept a new command string.

**NOTE**

For interfaces the that do not support a low-level device clear, use the **ABORT** command.

---

## An Introduction to the SCPI Language

Standard Commands for Programmable Instruments (SCPI) defines how you communicate with an instrument from a bus controller. The SCPI language uses a hierarchical structure similar to the file systems used by many bus controllers. The command tree is organized with root-level commands (also called subsystems) positioned at the top, with multiple levels below each root-level command. You must specify the complete path to execute the individual lower-level commands.

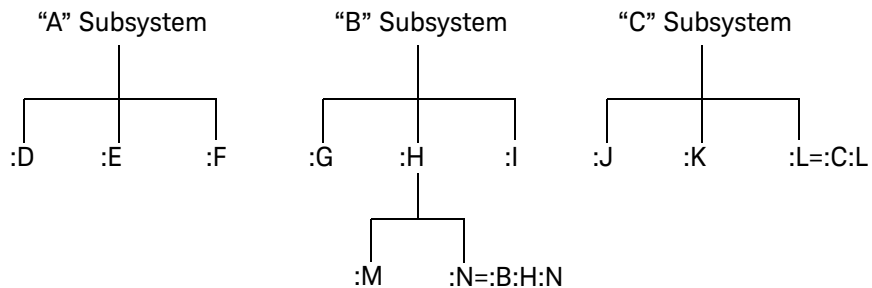

**Figure 1-9** Hierarchical structure of SCPI

### Mnemonic Forms

Each keyword has both a long and a short form. A standard notation is used to differentiate the short form keyword from the long form keyword. The long form of the keyword is shown, with the short form portion shown in uppercase characters, and the rest of the keyword shown in lowercase characters. For example, the short form of **TRIGger** is **TRIG**.

### Using a Colon (:)

When a colon is the first character of a command keyword, it indicates that the next command mnemonic is a root-level command. When a colon is inserted between two command mnemonics, the colon moves the path down one level in the present path (for the specified root-level command) of the command tree. You *must* separate command mnemonics from each other using a colon. You *can omit* the leading colon if the command is the first of a new program line.

## Using a Semicolon (;)

Use a semicolon to separate two commands within the same command string. The semicolon does not change the present path specified. For example, the following two statements are equivalent. Note that in the first statement the first colon is optional but the third is compulsory.

```
:DISP:FORM DIG;:DISP:RES 2  
:DISP:FORM DIG;RES 2
```

## Using a Comma (,)

If a command requires more than one parameter, you must separate adjacent parameters using a comma.

## Using Whitespace

You *must* use whitespace characters, [tab], or [space] to separate a parameter from a command keyword. Whitespace characters are generally ignored *only* in parameter lists.

## Using “?” Commands

The bus controller may send commands at any time, but a SCPI instrument may only send responses when *specifically* instructed to do so. Only query commands (commands that end with a “?”) instruct the instrument to send a response message. Queries return either measured values or internal instrument settings.

**NOTE**

If you send two query commands without reading the response from the first, then attempt to read the second response, you may receive some data from the first response followed by the complete second response. To avoid this, do not send a query command without reading the response. When you cannot avoid this situation, send a device clear before sending the second query command.

---

## Using “\*” Commands

Commands starting with a “\*” are called common commands. They are required to perform the identical function for *all* instruments that are compliant with the IEEE-488.2 interface standard. The “\*” commands are used to control reset, self-test, and status operations in the power meter.

## Syntax Conventions

Throughout this guide, the following conventions are used for SCPI command syntax.

- Square brackets ([]) indicate optional keywords or parameters.
- Braces ({} ) enclose one or more parameters that may be included zero or more times.
- Triangle brackets (<>) indicate that you must substitute a value for the enclosed parameter.
- Bars (|) can be read as “or” and are used to separate alternative parameter options.

## Syntax Diagram Conventions

- Solid lines represent the recommended path.
- Ovals enclose command mnemonics. The command mnemonic must be entered exactly as shown.
- Dotted lines indicate an optional path for by passing secondary keywords.
- Arrows and curved intersections indicate command path direction.

## SCPI Data Types

The SCPI language defines different data formats for use in program messages and response messages. Instruments are flexible listeners and can accept commands and parameters in various formats. However, SCPI instruments are precise talkers. This means that SCPI instruments *always* respond to a particular query in a predefined, rigid format.

### <boolean> Definition

Throughout this document <boolean> is used to represent **ON|OFF|<NRF>**. boolean parameters have a value of 0 or 1 and are unitless. **ON** corresponds to **1** and **OFF** corresponds to **0**.

On input, an <NRF> is rounded to an integer. A nonzero result is interpreted as **1**.

Queries always return a **1** or **0**, never **ON** or **OFF**.

### <character\_data> Definition

Throughout this document <character\_data> is used to represent character data, that is, A -Z, a -z, 0 -9 and \_ (underscore). For example: START and R6\_5F. The format is defined as:

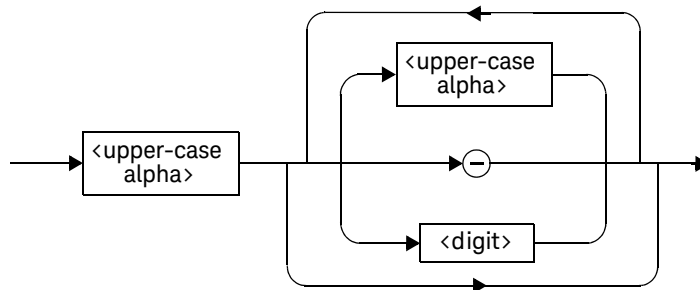

**Figure 1-10** Format of <character\_data>

**<NAN> Definition**

Not a number (NAN) is represented as 9.91 E37. Not a number is defined in IEEE 754.

**<non-decimal numeric> Definition**

Throughout this document **<non-decimal numeric>** is used to represent numeric information in bases other than ten (that is, hexadecimal, octal and binary). The following syntax diagram shows the standard for these three data structures. For examples, #HA2F, #ha4e, #Q62, #q15, #B01011.



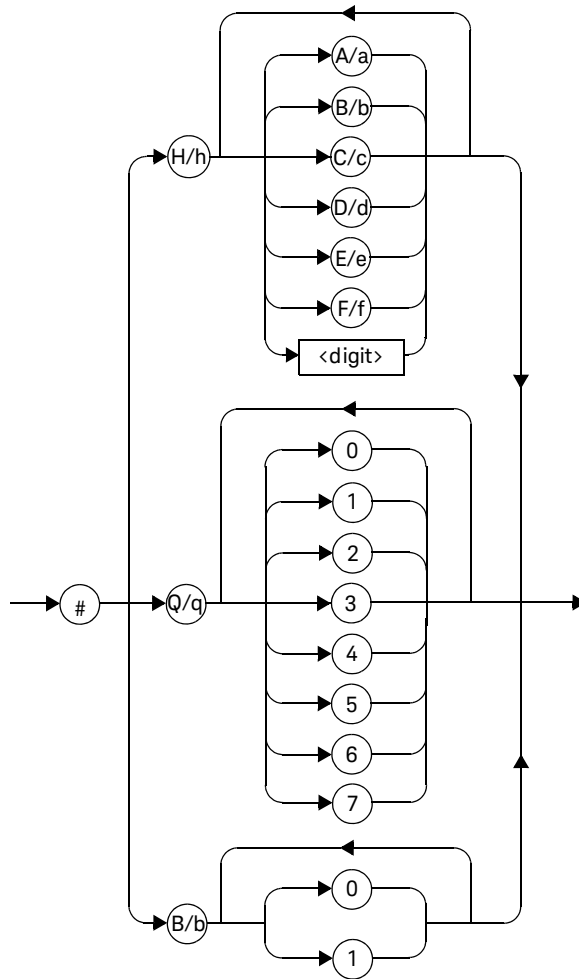

**Figure 1-11** Format of <non-decimal numeric>

Refer to section 7.7.4.1 of IEEE 488.2 for further details.

#### <NRf> Definition

Throughout this document <NRf> is used to denote a flexible numeric representation. For example: +200; -56; +9.9E36. Refer to section 7.7.2.1 of IEEE 488.2 for further details.

**<NR1> Definition**

Throughout this document <NR1> numeric response data is defined as:

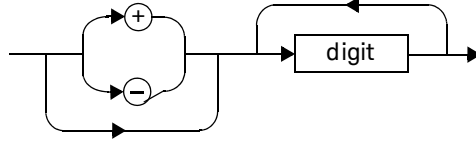

**Figure 1-12** Format of <NR1>

For example:

- 146
- +146
- -12345

Refer to section 8.7.2 of IEEE 488.2 for further details.

**<NR2> Definition**

Throughout this document <NR2> numeric response data is defined as:

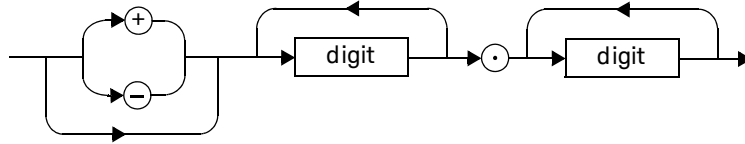

**Figure 1-13** Format of <NR2>

For example:

- 12.3
- +1.2345
- -0.123

Refer to section 8.7.3 of IEEE 488.2 for further details.

**<NR3> Definition**

Throughout this document <NR3> numeric response data is defined as:

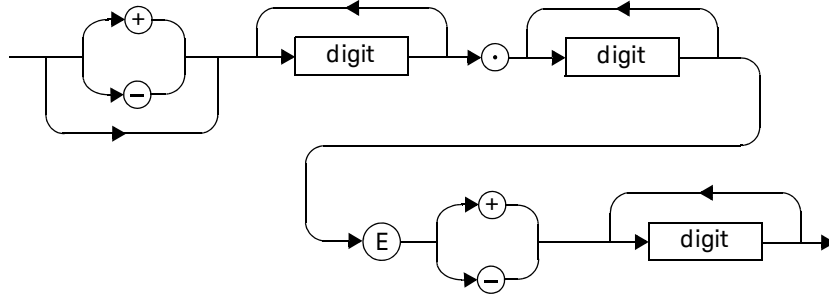

**Figure 1-14** Format of <NR3>

For example:

- 1.23E+6
- 123.4E-54
- -1234.567E+90

Refer to section 8.7.4 of IEEE 488.2 for further details.

**<numeric\_value> Definition**

Throughout this document the decimal numeric element is abbreviated to <numeric\_value>. For example, <NRf>, MINimum, MAXimum, DEFault or Not A Number (NAN).

**<string> Definition**

Throughout this document <string> is used to represent 7-bit ASCII characters.

The format is defined as:

**Program Data**

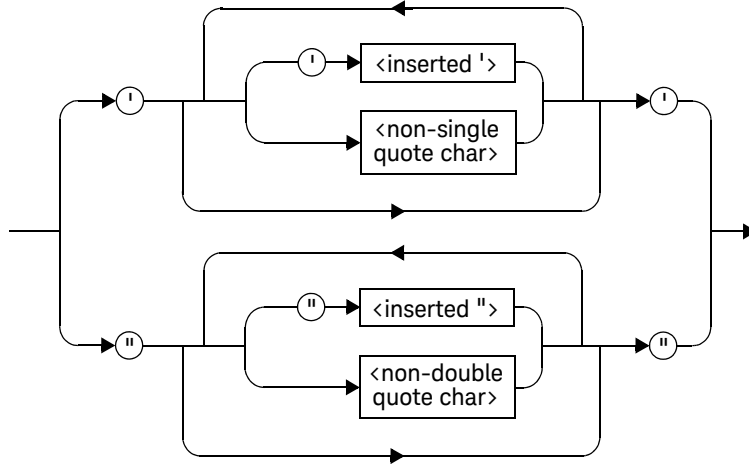

**Response Data**

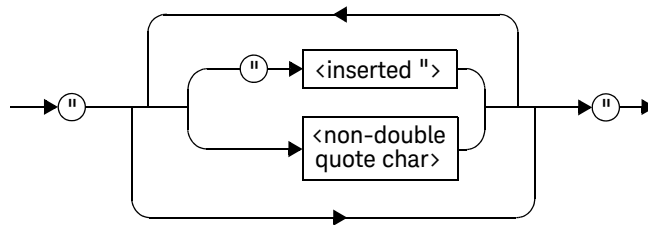

**Figure 1-15** Format of <string>

### Input Message Terminators

Program messages sent to a SCPI instrument *must* terminate with a <newline> character. The IEEE.488 EOI (end or identify) signal is interpreted as a <newline> character and may also be used to terminate a message in place of the <newline> character. A <carriage return> followed by a <newline> is also accepted. Many programming languages allow you to specify a message terminator character or EOI state to be automatically sent with each bus transaction. Message termination *always* sets the current path back to the root-level.

## SCPI Compliance Information

The power meter complies with the rules and regulations of the present version of SCPI (Standard Commands for Programmable Instruments). You can determine the SCPI version with which the power meter's is in compliance by sending the **SYSTEM:VERSION?** command from the remote interface.

The following commands are device-specific to the power meter. They are not included in the 1999.0 version of the SCPI standard. However, these commands are designed with the SCPI format in mind and they follow all of the syntax rules of the standard.

```

CALibration[1|2]:RCALibration
CALibration[1|2]:RCFactor
DISPlay[:WINDow[1|2]]:FORMat
DISPlay[:WINDow[1|2]]:METer:LOWer
DISPlay[:WINDow[1|2]]:METer:UPPer
DISPlay[:WINDow[1|2]]:RESolution
DISPlay[:WINDow[1|2]]:SElect
MEMory:CLEar[:NAME]
MEMory:TABLE:SElect
MEMory:STATE:DEFine
MEMory:TABLE:GAIN[:MAGNitude]
MEMory:TABLE:GAIN:POINTs?
MEMory:TABLE:MOVE
[SENSe[1]] | SENSe2:AVERage:SDETect
[SENSe[1]] | SENSe2:CORRection:CFACTOR
[SENSe[1]] | SENSe2:CORRection:DCYCLe
[SENSe[1]] | SENSe2:CORRection:FDOFFset
[SENSe[1]] | SENSe2:SPEEd
[SENSe[1]] | SENSe2:POWer:AC:RANGe
SERVice:SENSor[1|2]:CDATE?
SERVice:SENSor[1|2]:CPLace?
SERVice:SENSor[1|2]:SNUMber?
SERVice:SENSor[1|2]:TYPE?
SYSTEM:COMMunicate:LAN:AIP
SYSTEM:COMMunicate:LAN:CURRent:ADDReSS?
SYSTEM:COMMunicate:LAN:CURRent:DGATeway?

```

## 1 Power Meter Remote Operation

```
SYSTem:COMMunicate:LAN:CURRent:DNAMe?  
SYSTem:COMMunicate:LAN:CURRent:SMASk?  
SYSTem:COMMunicate:LAN:ADDResS  
SYSTem:COMMunicate:LAN:DGATeway  
SYSTem:COMMunicate:LAN:DHCP  
SYSTem:COMMunicate:LAN:HNAME  
SYSTem:COMMunicate:LAN:REStArt  
SYSTem:COMMunicate:LAN:SMASk  
SYSTem:LOCAl  
SYSTem:REMOte  
SYSTem:RWLock  
UNIT[1|2]:POWer:RATio
```

## Summary of Commands

For detail of each SCPI (Standard Commands for Programmable Instruments) command available to program the power meter, refer to later chapters for more details on each command.

In different subsystems the numeric suffix of program mnemonics can represent either a channel selection or a window selection. Refer to the appropriate command description to verify the meaning of the numeric suffix.

With commands that require you to specify a channel, Channel A is represented by a 1 and Channel B by a 2. If you omit the channel number, Channel A is assumed.

With commands that require you to specify a window, the upper window is represented by a 1 and the lower window by a 2. If you omit the window number, the upper window is assumed.

All the commands listed also have queries unless otherwise stated in the “Notes” column.

## Making Measurements on Wireless Communication Standards

The following sections describe typical measurements you may want to make. They are also described, for soft front panel operation, in the *User's Guide*.

The optimum method of measuring these Wireless Communication Standards is to use the **SYSTem:PRESet <character\_data>** command and use one of the following values.

- **GSM900** -See “**GSM900**” on page 480 for greater detail.
- **EDGE** -See “**EDGE**” on page 483 for greater detail.
- **CDMAone** -See “**CDMAone**” on page 487 for greater detail.
- **CDMA2000** -See “**CDMA2000**” on page 491 for greater detail.
- **WCDMA** -See “**W-CDMA**” on page 495 for greater detail.
- **BLUetooth** -See “**BLUetooth**” on page 499 for greater detail.
- **MCPa** -See “**MCPa**” on page 502 for greater detail.
- **RADar** -See “**RADAR**” on page 505 for greater detail.
- **WL802DOT11A** -See “**802.11a and HiperLan2**” on page 508 for greater detail.
- **WL802DOT11B** -See “**892.11b/g**” on page 511 for greater detail.
- **XEVDO** -See “**1xEV-DO**” on page 514 for greater detail.
- **XEVDV** -See “**1xEV-DV**” on page 518 for greater detail.
- **TDSCdma** -See “**TD-SCDMA**” on page 521 for greater detail.
- **NADC** -See “**NADC**” on page 524 for greater detail.
- **IDEN** -See “**iDEN**” on page 528 for greater detail.
- **DVB** -See “**DVB**” on page 532 for greater detail.
- **HIPERLAN2** -See “**802.11a and HiperLan2**” on page 508 for greater detail.



## Starting a Preset Example

```
10 *CLS !Clears error queue
20 *RST !Resets meter settings to their default states
30 :SYST:ERR? <read string> !The system error query should
!return "0: No Error"
40 SERV:SENS:TYPE? !The sensor type query should return one
!of the following:N1921A|N1922A The GSM setup is only valid
!with these sensors
50 SYSTem:PRESet "GSM900"
```

THIS PAGE HAS BEEN INTENTIONALLY LEFT BLANK.

## 2 MEASurement Commands

MEASurement Commands	125
CONFigure[1]  2 3 4?	130
CONFigure [1]  2 3 4 Commands	132
CONFigure[1] 2 3 4[:SCALar][:POWer:AC] [<expected_value>[,<resolution>[,<source list>]]]	133
CONFigure[1] 2 3 4[:SCALar][:POWer:AC]:RELative [<expected_value>[,<resolution>[,<source list>]]]	135
CONFigure[1] 2 3 4[:SCALar][:POWer:AC]:DIFFerence [<expected_value>[,<resolution>[,<source list>]]]	137
CONFigure[1] 2 3 4[:SCALar][:POWer:AC]:DIFFerence: RELative [<expected_value>[,<resolution>[,<source list>]]]	139
CONFigure[1] 2 3 4[:SCALar][:POWer:AC]:RATio [<expected_value>[,<resolution>[,<source list>]]]	141
CONFigure[1] 2 3 4[:SCALar][:POWer:AC]:RATio: RELative[<expected_value>[,<resolution>[,<source list>]]]	143
FETCH[1] 2 3 4 Queries	145
FETCH[1] 2 3 4[:SCALar][:POWer:AC]? [<expected_value>[,<resolution>[,<source list>]]]	146
FETCH[1] 2 3 4[:SCALar][:POWer:AC]:RELative? [<expected_value>[,<resolution>[,<source list>]]]	148
FETCH[1] 2 3 4[:SCALar][:POWer:AC]:DIFFerence? [<expected_value>[,<resolution>[,<source list>]]]	150
FETCH[1] 2 3 4[:SCALar][:POWer:AC]:DIFFerence: RELative? [<expected_value>[,<resolution>[,<source list>]]]	152
FETCH[1] 2 3 4[:SCALar][:POWer:AC]:RATio? [<expected_value>[,<resolution>[,<source list>]]]	154
FETCH[1] 2 3 4[:SCALar][:POWer:AC]:RATio:RELative? [<expected_value>[,<resolution>[,<source list>]]]	156
READ[1] 2 3 4 Commands	158

READ[1]2 3 4[:SCALar][:POWer:AC]? [<expected_value>[,<resolution>[,<source list>]]]	159
READ[1]2 3 4[:SCALar][:POWer:AC]:RELative? [<expected_value>[,<resolution>[,<source list>]]]	161
READ[1]2 3 4[:SCALar][:POWer:AC]:DIFFerence? [<expected_value>[,<resolution>[,<source list>]]]	163
READ[1]2 3 4[:SCALar][:POWer:AC]:DIFFerence: RELative? [<expected_value>[,<resolution>[,<source list>]]]	165
READ[1]2 3 4[:SCALar][:POWer:AC]:RATio? [<expected_value>[,<resolution>[,<source list>]]]	167
READ[1]2 3 4[:SCALar][:POWer:AC]:RATio:RELative? [<expected_value>[,<resolution>[,<source list>]]]	169
MEASure[1]2 3 4 Commands	171
MEASure[1]2 3 4[:SCALar][:POWer:AC]? [<expected_value>[,<resolution>[,<source list>]]]	172
MEASure[1]2 3 4[:SCALar][:POWer:AC]:RELative? [<expected_value>[,<resolution>[,<source list>]]]	174
MEASure[1]2 3 4[:SCALar][:POWer:AC]:DIFFerence? [<expected_value>[,<resolution>[,<source list>]]]	176
MEASure[1]2 3 4[:SCALar][:POWer:AC]:DIFFerence: RELative? [<expected_value>[,<resolution>[,<source list>]]]	178
MEASure[1]2 3 4[:SCALar][:POWer:AC]:RATio? [<expected_value>[,<resolution>[,<source list>]]]	180
MEASure[1]2 3 4[:SCALar][:POWer:AC]:RATio:RELative? [<expected_value>[,<resolution>[,<source list>]]]	182

This chapter explains how to use the **MEASure** group of instructions to acquire data using a set of high level instructions.

## MEASurement Commands

Measurement commands are high level commands used to acquire data. They enable you to trade interchangeability against fine control of the measurement process.

Measurement Command	Descriptions
MEASure?	Provides the simplest way to program a power meter for measurements. <b>MEASure?</b> is a compound command which is equivalent to an <b>ABORT</b> followed by a <b>CONFigure</b> and a <b>READ?</b> . It does not enable much flexibility or control over measurement settings.
CONFigure	Used to change the power meter's configuration values. <b>CONFigure</b> must then be followed by another command which takes the measurement—for example, a <b>READ?</b> followed by a <b>FETCh?</b> .
READ?	Takes a measurement using parameters previously set up using either <b>CONFigure</b> or lower level commands. <b>READ?</b> is equivalent to an <b>ABORT</b> followed by an <b>INITiate1</b> (which performs the data acquisition) and a <b>FETCh?</b>
FETCh?	Retrieves measurements taken by <b>INITiate</b> <sup>[a]</sup> .

[a] **INITiate** is described in [Chapter 14](#), "TRIGger Subsystem," on page 565.

The **CONFigure**, **FETCh?**, **READ?** and **MEASure?** commands all have a numeric suffix which refers to a specific window/measurement. [Figure 2-1](#) shown an example of the configuration returned result windows.

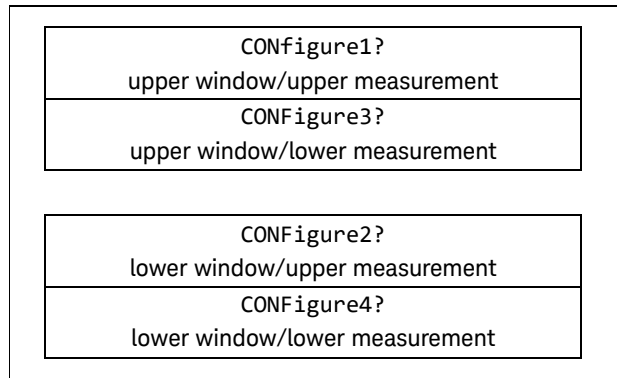

**Figure 2-1** Measurement display CONFigure block window

## Optional Parameters

**CONFigure**, **FETCH?**, **READ?** and **MEASure?** have the following three optional parameters:

- An expected power value
- A resolution
- A source list

### Expected Power Value

An **<expected\_value>** parameter is only required if you are using an E-Series power sensor. It has no effect on P-Series or 8480 Series Power Sensor. The value entered determines which of the power sensor's two ranges is used for the measurement. If the current setting of the power sensor's range is no longer valid for the new measurement, specifying the expected power value decreases the time taken to obtain a result.

## Resolution

The **<resolution>** parameter sets the resolution of the specified window. This parameter does not affect the resolution of the remote data but it does affect the auto averaging setting. Where a channel is set up in both the upper and lower window and the **<resolution>** parameter settings for these windows are different, the highest resolution setting is taken to calculate the averaging. If you are making a ratio or difference measurement the **<resolution>** parameters are applied to both channels.

## Source List

The **<source list>** parameter is used to define:

- What channels the measurements will be made on, for a dual channel measurement.
- Whether the calculation is A-B or B-A, for a dual channel difference measurement.
- Whether the calculation is A/B or B/A, for a ratio measurement.

Enter a **<source list>** is required before you proceed.

The following commands are described in this chapter:

Keyword	Parameter Form	Notes	Page
CONFigure[1] 2 3 4?		[query only]	<a href="#">page 130</a>
CONFigure[1] 2 3 4			
[ :SCALar]			
[ :POWer:AC]	[<expected_value> [,<resolution>[,<source list>]]]	[no query]	<a href="#">page 133</a>
:RELative	[<expected_value> [,<resolution>[,<source list>]]]	[no query] [non-SCPI]	<a href="#">page 135</a>
:DIFFerence	[<expected_value> [,<resolution>[,<source list>]]]	[no query] [non-SCPI]	<a href="#">page 137</a>
:RELative	[<expected_value> [,<resolution>[,<source list>]]]	[no query] [non-SCPI]	<a href="#">page 139</a>

Keyword	Parameter Form	Notes	Page
:RATio	[<expected_value> [,<resolution>[,<source list>]]]	[no query]	page 141
:RELative	[<expected_value> [,<resolution>[,<source list>]]]	[no query] [non-SCPI]	page 143
FETCh[1] 2 3 4			
[:SCALar]			
[:POWer:AC]?	[<expected_value> [,<resolution>[,<source list>]]]	[query only]	page 146
:RELative?	[<expected_value> [,<resolution>[,<source list>]]]	[query only] [non-SCPI]	page 148
:DIFFerence?	[<expected_value> [,<resolution>[,<source list>]]]	[query only] [non-SCPI]	page 150
:RELative?	[<expected_value> [,<resolution>[,<source list>]]]	[query only] [non-SCPI]	page 152
:RATio?	[<expected_value> [,<resolution>[,<source list>]]]	[query only]	page 154
:RELative?	[<expected_value> [,<resolution>[,<source list>]]]	[query only] [non-SCPI]	page 156
READ[1] 2 3 4			
[:SCALar]			
[:POWer:AC]?	[<expected_value> [,<resolution>[,<source list>]]]	[query only]	page 159
:RELative?	[<expected_value> [,<resolution>[,<source list>]]]	[query only] [non-SCPI]	page 161
:DIFFerence?	[<expected_value> [,<resolution>[,<source list>]]]	[query only] [non-SCPI]	page 163
:RELative?	[<expected_value> [,<resolution>[,<source list>]]]	[query only] [non-SCPI]	page 165
:RATio?	[<expected_value> [,<resolution>[,<source list>]]]	[query only]	page 167



Keyword	Parameter Form	Notes	Page
:RELative?	[<expected_value> [,<resolution>[,<source list>]]]	[query only] [non-SCPI]	<a href="#">page 169</a>
MEASure[1] 2 3 4			
[:SCALar]			
[:POWer:AC]?	[<expected_value> [,<resolution>[,<source list>]]]	[query only]	<a href="#">page 172</a>
:RELative?	[<expected_value> [,<resolution>[,<source list>]]]	[query only] [non-SCPI]	<a href="#">page 174</a>
:DIFFerence?	[<expected_value> [,<resolution>[,<source list>]]]	[query only] [non-SCPI]	<a href="#">page 176</a>
:RELative?	[<expected_value> [,<resolution>[,<source list>]]]	[query only] [non-SCPI]	<a href="#">page 178</a>
:RATio?	[<expected_value> [,<resolution>[,<source list>]]]	[query only]	<a href="#">page 180</a>
:RELative?	[<expected_value> [,<resolution>[,<source list>]]]	[query only] [non-SCPI]	<a href="#">page 182</a>

## CONFigure[1] |2|3|4?

This query returns the present configuration of the specified window/measurement.

## Syntax

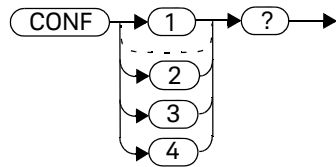

The string returned depends on the setting of the **CALCulate:MATH** and **CALCulate:RElative:STATe** commands.

The configuration is returned as a quoted string in the following format:

“<function> <expected\_value>,<resolution>,<source list>”

CALCulate:MATH	CALCulate:RElative:STATe	Function	<source list>
(SENSe1)	OFF	:POW:AC	(@1)
(SENSe2)	OFF	:POW:AC	(@2)
(SENSe1)	ON	:POW:AC:REL	(@1)
(SENSe2)	ON	:POW:AC:REL	(@2)
(SENSe1 - SENSe2)	OFF	:POW:AC:DIFF	(@1),(@2)
(SENSe2 - SENSe1)	OFF	:POW:AC:DIFF	(@2),(@1)
(SENSe1 - SENSe2)	ON	:POW:AC:DIFF:REL	(@1),(@2)
(SENSe2 - SENSe1)	ON	:POW:AC:DIFF:REL	(@2),(@1)
(SENSe1 - SENSe1)	OFF	:POW:AC:DIFF	(@1),(@1)
(SENSe2 - SENSe2)	OFF	:POW:AC:DIFF	(@2),(@2)
(SENSe1 - SENSe1)	ON	:POW:AC:DIFF:REL	(@1),(@1)
(SENSe2 - SENSe2)	ON	:POW:AC:DIFF:REL	(@2),(@2)
(SENSe2/SENSe1)	OFF	:POW:AC:RAT	(@1),(@2)

CALCulate:MATH	CALCulate:RELative:STATe	Function	<source list>
(SENSe2/SENSe1)	OFF	:POW:AC:RAT	(@2),(@1)
(SENSe1/SENSe2)	ON	:POW:AC:RAT:REL	(@1),(@2)
(SENSe2/SENSe1)	ON	:POW:AC:RAT:REL	(@2),(@1)
(SENSe1/SENSe1)	OFF	POW:AC:RAT	(@1),(@1)
(SENSe2/SENSe2)	OFF	POW:AC:RAT	(@2),(@2)
(SENSe1/SENSe1)	ON	POW:AC:RAT:REL	(@1),(@1)
(SENSe2/SENSe2)	ON	POW:AC:RAT:REL	(@2),(@2)

<expected\_value> returns the expected value sent by the last **CONFigure** command or +20 dBm by default. Note that when the display is showing dual windows this value is meaningless.

The <resolution> returned is the same as the value returned by **DISPlay:WINDow:RESolution?**. The format of the return is <NR1> in the range 1 through 4.

## Example

**CONF2?**

*This command queries the current configuration of the lower window/upper measurement.*

## Reset Condition

On reset:

The command function is set to **:POWer:AC**.

The expected power level is set to +20 dBm.

The source list on the N8262A is set to Channel A for the upper measurement on both windows and Channel B for the lower measurement on both windows.

## CONFigure [1] |2|3|4 Commands

The **CONFigure** commands are used on the specified window/measurement to set:

- The expected power level being measured.
- The resolution of the window/measurement.
- The channel(s) on which the measurement is to be made.

The **CONFigure** commands do not make the power measurement after setting the configuration. Use **READ?**, or alternatively use **INITiate** followed by a **FETCh?** to make the measurement.

The **CONFigure** command also applies the following defaults to the channel(s) which are in the specified window (the channel(s) in the window are specified in the `<source list>` parameter):

Default Settings	Description
<b>INITiate:CONTInuous</b> OFF	Sets the power meter to make one trigger cycle when <b>INITiate</b> is sent.
<b>TRIGger:SOURce</b> <b>IMMediate</b>	When <b>TRIG:SOUR</b> is set to <b>BUS</b> or <b>HOLD</b> , sets the power meter to make the measurement immediately a trigger is received.
<b>TRIGger:DELay:AUTO</b> ON	Enables automatic delay before making the measurement.
<b>SENSE:AVERAge:COUNT:AUTO</b> ON	Enables automatic filter length selection.
<b>SENSE:AVERAge:STATE</b> ON	Enables averaging.

CONFigure[1]|2|3|4[:SCALar][:POWer:AC]  
 [<expected\_value>[,<resolution>[,<source list>]]]

This command is used on the specified window/measurement to set:

- The expected power level of the measurement.
- The resolution of the window/measurement.
- The channel on which the measurement will be made.

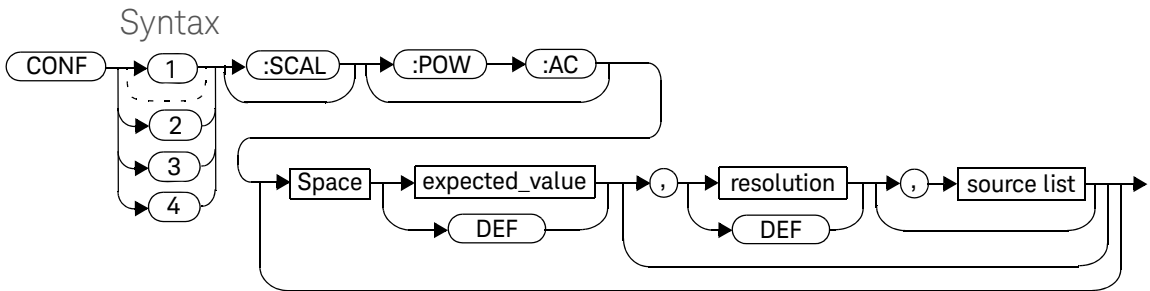

### Parameters

Refer to “Optional Parameters” on page 126 for additional details on the parameters in this command.

Item	Description/Default	Range of Values
expected_value	A numeric value for the expected power level. The units of measurement are dBm and W. The default units are defined by UNIT:POWer.	Sensor dependent. DEF <sup>[a]</sup>

Item	Description/Default	Range of Values
resolution	A numeric value for the resolution. If unspecified the current resolution setting is used.	1 to 4 <sup>[b]</sup> 1.0, 0.1, 0.01, 0.001 <b>DEF</b> <sup>[a]</sup>
source list	The channel which the command is implemented on. If unspecified the current window setup is used. However, if the window shows a ratio or difference measurement, the upper window defaults to Channel A and the lower window to Channel B.	(@1) (@2)

[a] The mnemonic **DEF** means DEFault. This is not equivalent to the DEFault parameter used in the command sub-systems. The parameters must be entered in the specified order. If parameters are omitted, they default from the right. The parameter DEFault is used as a place holder. Specifying **DEF** leaves the parameter value unchanged.

[b] When the measurement result is linear this parameter represents the number of significant digits. When the measurement result is logarithmic 1 to 4 represents of 1, 0.1, 0.01 and 0.001 respectively.

## Example

**CONF1:POW:AC DEF,2,(@1)**

*This command configures the upper window/ upper measurement to measure the power of Channel A, using the current sensor range and a resolution setting of 2.*

## CONFigure[1]|2|3|4[:SCALar][:POWer:AC]:RELative [<expected\_value>[,<resolution>[,<source list>]]]

This command sets the measurement function, range and resolution of the specified window. It sets the measurement function to single channel with relative mode on. The relative value used is that set by the **CALCulate:RELative:MAGNitude:AUTO** command.

### Syntax

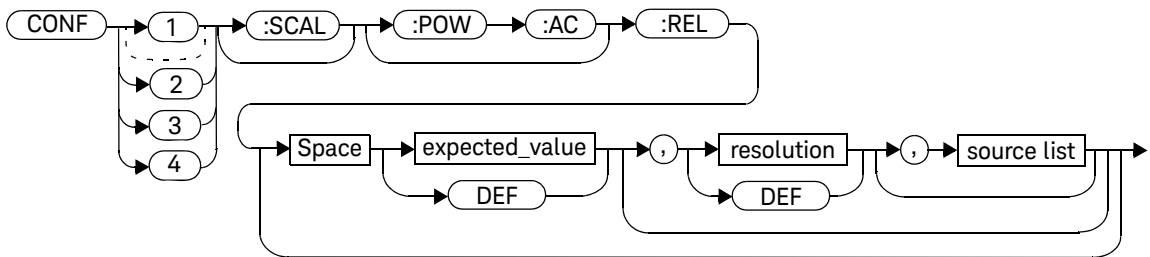

### Parameters

Refer to “**Optional Parameters**” on page 126 for additional details on the parameters in this command.

Item	Description/Default	Range of Values
expected_value (for the expected power level)	A numeric value for the expected power level. The units of measurement are dBm and W. The default units are defined by <b>UNIT:POWer</b> .	Sensor dependent <b>DEF</b> <sup>[a]</sup>

## 2 MEASurement Commands

Item	Description/Default	Range of Values
resolution	A numeric value for the resolution. If unspecified the current resolution setting is used.	1 to 4 <sup>[b]</sup> 1.0, 0.1, 0.01, 0.001 <b>DEF</b> <sup>[a]</sup>
source list	The channel which the command is implemented on. If unspecified the current window setup is used. However, if the window shows a ratio or difference measurement, the upper window defaults to Channel A and the lower window to Channel B.	(@1) (@2)

[a] The mnemonic **DEF** means DEFault. This is not equivalent to the DEFault parameter used in the command sub-systems. The parameters must be entered in the specified order. If parameters are omitted, they default from the right. The parameter DEFault is used as a place holder. Specifying **DEF** leaves the parameter value unchanged.

[b] When the measurement result is linear this parameter represents the number of significant digits. When the measurement result is logarithmic 1 to 4 represents of 1, 0.1, 0.01 and 0.001 respectively.

### Example

**CONF2:REL -50DBM,3,(@1)**

*This command configures the lower window/upper measurement to measure the relative power of Channel A, using an expected power level of -50 dBm and a resolution setting of 3.*



# CONFigure[1]|2|3|4[:SCALAR][:POWER:AC]:DIFFerence [<expected\_value>[,<resolution>[,<source list>]]]

This command sets the measurement function and resolution of the specified window. It sets the measurement function to difference with relative mode off.

## Syntax

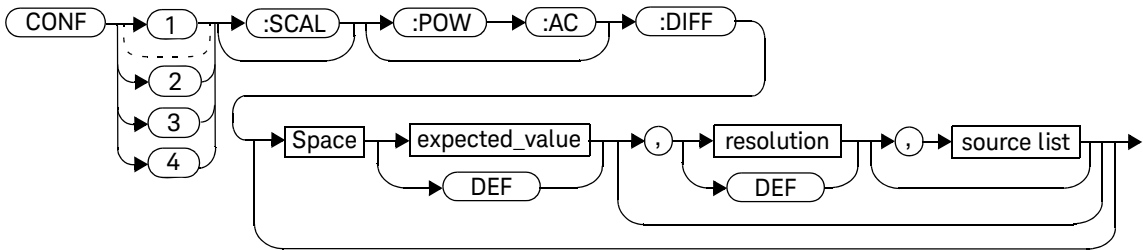

## Parameters

Refer to “Optional Parameters” on page 126 for additional details on the parameters in this command.

Item	Description/Default	Range of Values
expected_value (for the expected power level)	The power meter ignores the numeric value entered in this parameter. Any value entered is treated like DEF.	Sensor dependent DEF <sup>[a]</sup>
resolution	A numeric value for the resolution. If unspecified the current resolution setting is used.	1 to 4 <sup>[b]</sup> 1.0, 0.1, 0.01, 0.001 DEF <sup>[a]</sup>
source list	This channel list specifies between which channels the difference is calculated. If unspecified and the current window setup is a difference measurement then this difference setup is used, otherwise it defaults to Channel A-B.	(@1),(@2) (@2),(@1) (@1),(@1) (@2),(@2)

[a] The mnemonic DEF means DEFault. This is not equivalent to the DEFault parameter used in the command sub-systems. The parameters must be entered in the specified order. If parameters are omitted, they default from the right. The parameter DEFault is used as a place holder. Specifying DEF leaves teh parameter value unchanged.

[b] When the measurement result is linear this parameter represents the number of significant digits. When the measurement result is logarithmic 1 to 4 represents a resolution of 1, 0.1, 0.01 and 0.001 respectively.

### Example

```
CONF2:DIFF DEF,1,(@2),(@1)
```

*This command configures the lower window/upper measurement to make a difference measurement of Channel B -Channel A, using the current sensor range and a resolution of 1 on both channels.*

# CONFigure[1]|2|3|4[:SCALar][:POWer:AC]:DIFFerence: RELative [<expected\_value>[,<resolution>[,<source list>]]]

This command sets the measurement function, range and resolution of the specified window. It sets the measurement function to difference with relative mode on. The relative value used is set by the **CALCulate:RELative:MAGNitude:AUTO** command.

## Syntax

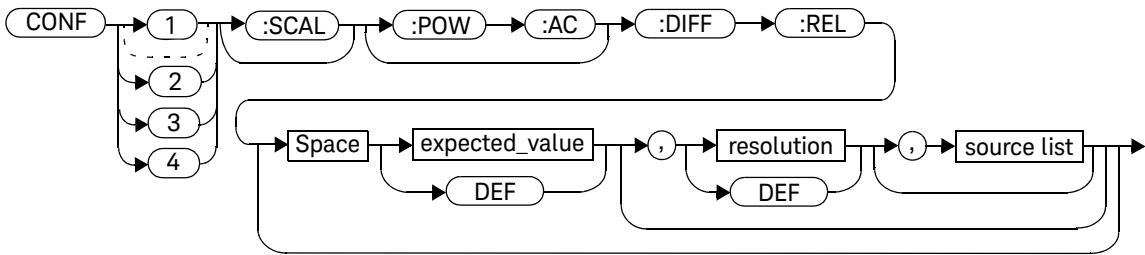

## Parameters

Refer to **“Optional Parameters”** on page 126 for additional details on the parameters in this command.

Item	Description/Default	Range of Values
expected_value (for the expected power level)	The power meter ignores the numeric value entered in this parameter. Any value entered is treated like <b>DEF</b> .	Sensor dependent <b>DEF</b> <sup>[a]</sup>
resolution	A numeric value for the resolution. If unspecified the current resolution setting is used.	1 to 4 <sup>[b]</sup> 1.0, 0.1, 0.01, 0.001 <b>DEF</b> <sup>[a]</sup>
source list	This channel list specifies the channels used to calculate the difference.  If unspecified and the current window setup is a difference measurement then this difference setup is used, otherwise it defaults to Channel A-B.	(@1),(@2) (@2),(@1) (@1),(@1) (@2),(@2)

## 2 MEASurement Commands

- [a] The mnemonic **DEF** means DEFAult. This is not equivalent to the DEFAult parameter used in the command sub-systems. The parameters must be entered in the specified order. If parameters are omitted, they default from the right. The parameter DEFAult is used as a place holder. Specifying **DEF** leaves teh parameter value unchanged.
- [b] When the measurement result is linear this parameter represents the number of significant digits. When the measurement result is logarithmic 1 to 4 represents of 1, 0.1, 0.01 and 0.001 respectively.

### Example

```
CONF1:DIFF:REL DEF,1,(@1),  
(@2)
```

*This command configures the upper window/  
upper measurement to make a difference  
measurement of Channel A - Channel B with  
relative mode on, using the current sensor  
range and a resolution of 1 on both channels.*

# CONFigure[1]|2|3|4[:SCALar][:POWer:AC]:RATio [<expected\_value>[,<resolution>[,<source list>]]]

This command sets the measurement function, range and resolution of the specified window. It sets the measurement function to ratio with relative mode off.

## Syntax

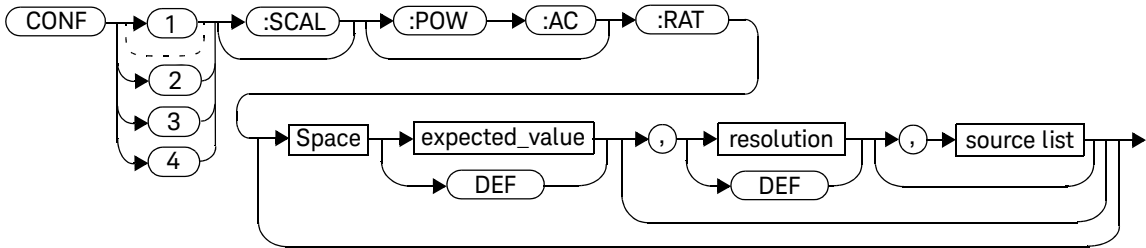

## Parameters

Refer to **“Optional Parameters”** on page 126 for additional details on the parameters in this command.

Item	Description/Default	Range of Values
expected_value (for the expected power level)	The power meter ignores the numeric value entered in this parameter. Any value entered is treated like DEF.	Sensor dependent DEF <sup>[a]</sup>
resolution	A numeric value for the resolution. If unspecified the current resolution setting is used.	1 to 4 <sup>[b]</sup> 1.0, 0.1, 0.01, 0.001 DEF <sup>[a]</sup>
source list	This channel list specifies the channels used to calculate the ratio. If unspecified and the current window setup is a ratio measurement then this ratio setup is used, otherwise it defaults to Channel A/B.	(@1),(@2) (@2),(@1) (@1),(@1) (@2),(@2)

[a] The mnemonic DEF means DEFault. This is not equivalent to the DEFault parameter used in the command sub-systems. The parameters must be entered in the specified order. If parameters are omitted, they default from the right. The parameter DEFault is used as a place holder. Specifying DEF leaves the parameter value unchanged.

[b] When the measurement result is linear this parameter represents the number of significant digits. When the measurement result is logarithmic 1 to 4 represents of 1, 0.1, 0.01 and 0.001 respectively.

## Example

```
CONF1:RAT DEF,4,(@1),(@2)
```

*This command configures the upper window/upper measurement to make a ratio measurement of Channel A over Channel B, using the current sensor range and a resolution setting of 4 on both channels.*

CONFigure[1]|2|3|4[:SCALAR][:POWER:AC]:RATio:  
RELative[<expected\_value>[,<resolution>[,<source list>]]]

This command sets the measurement function, range and resolution of the specified window. It sets the measurement function to ratio with relative mode on. The relative value used is that set by the **CALCulate:RELative:MAGNitude:AUTO** command.

Syntax

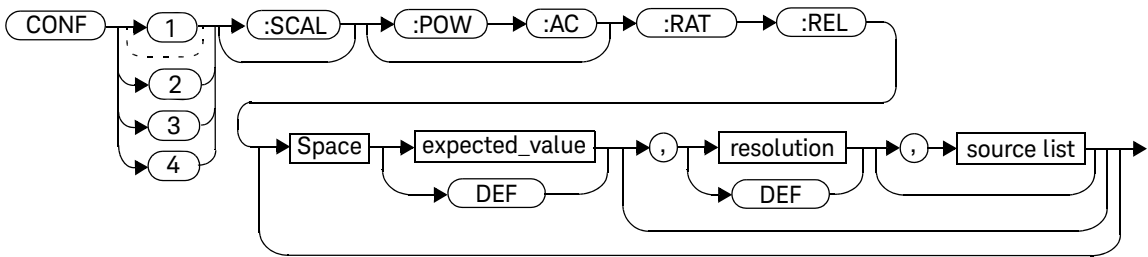

Parameters

Refer to **“Optional Parameters”** on page 126 for additional details on the parameters in this command.

Item	Description/Default	Range of Values
expected_value (for the expected power level)	The power meter ignores the numeric value entered in this parameter. Any value entered is treated like <b>DEF</b> .	Sensor dependent <b>DEF</b> <sup>[a]</sup>
resolution	A numeric value for the resolution. If unspecified the current resolution setting is used.	1 to 4 <sup>[b]</sup> 1.0, 0.1, 0.01, 0.001 <b>DEF</b> <sup>[a]</sup>
source list	This channel list specifies the channels used to calculate the ratio. If unspecified and the current window setup is a ratio measurement then this ratio setup is used, otherwise it defaults to Channel A/B.	(@1),(@2) (@2),(@1) (@1),(@1) (@2),(@2)

## 2 MEASurement Commands

- [a] The mnemonic **DEF** means DEFAult. This is not equivalent to the DEFAult parameter used in the command sub-systems. The parameters must be entered in the specified order. If parameters are omitted, they default from the right. The parameter DEFAult is used as a place holder. Specifying **DEF** leaves the parameter value unchanged.
- [b] When the measurement result is linear this parameter represents the number of significant digits. When the measurement result is logarithmic 1 to 4 represents of 1, 0.1, 0.01 and 0.001 respectively.

### Example

```
CONF1:RAT:REL  
DEF,1,(@1),(@2)
```

*This command configures the upper window/upper measurement to make a ratio measurement of Channel A over Channel B with relative mode on, using the current sensor range and a resolution setting of 1 on both channels.*



## FETCh[1]|2|3|4 Queries

The **FETCh?** queries set the specified window's measurement function. This can be set to either single channel, difference or ratio measurements, with relative mode either off or on. They then recalculate the measurement and place the result on the bus. The format of the result is set by **FORM[ :READ] [ :DATA]**. Refer to [Chapter 6](#), "FORMat Subsystem," on page 275 for further information.

The query returns a measurement result when it is valid. The measurement result is invalid under the following conditions:

- When **\*RST** is executed.
- Whenever a measurement is initiated.
- When any **SENSe** parameter, such as frequency, is changed.

If data is invalid, the **FETCh?** query is not completed until all data becomes valid. The exceptions to this are, if the power meter is in the idle state and the data is invalid, or the power meter has been reconfigured as defined above and no new measurement has been initiated. In such cases, the **FETCh?** routine generates the error -230, "Data corrupt or stale" and no result is returned. A common cause for this error is receiving a **FETCh?** after a **\*RST**. If the expected value and resolution parameters are not the same as those that were used to collect the data, error -221, "Settings conflict" occurs.

### NOTE

When **TRIG:SOUR** is **INT1**, **INT2** or **EXT** and a new acquisition has been initiated (using the **INIT** command for example), **FETCh?** waits until the trigger takes place before executing. If trigger conditions are not satisfied - when the trigger level differs greatly from the signal level for example - this can give the impression that the power meter has hung.

FETCh[1]|2|3|4[:SCALar][:POWer:AC]?  
 [<expected\_value>[,<resolution>[,<source list>]]]

This command sets the specified window's measurement function to single channel with relative mode off, recalculates the measurement and places the result on the bus. The result is a power based measurement and is expressed in the units defined by **UNIT[1]|2|3|4:POWer**.

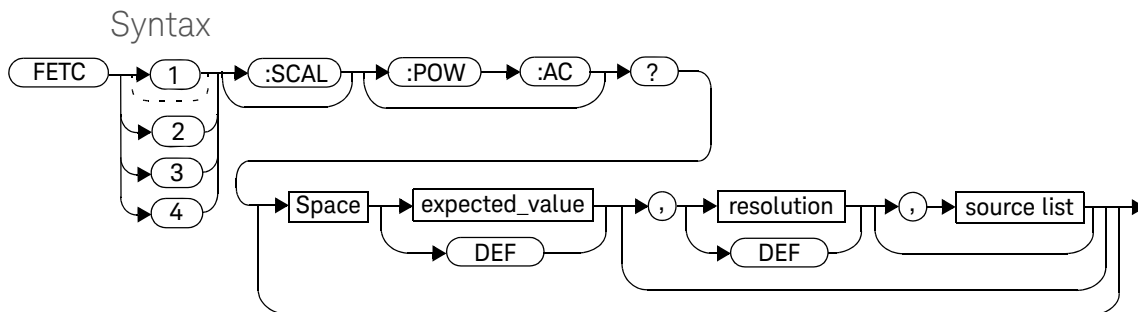

## Parameters

Refer to [“Optional Parameters”](#) on page 126 for additional details on the parameters in this command.

Item	Description/Default	Range of Values
expected_value (for the expected power level)	The expected power level parameter can be set to <b>DEF</b> or a numeric value. If a value is entered it should correspond to that set by <b>CONFigure</b> otherwise an error occurs. The units of measurement are dBm and W. The default units are defined by <b>UNIT:POWer</b> .	Sensor dependent <b>DEF</b> <sup>[a]</sup>

Item	Description/Default	Range of Values
resolution	A numeric value for the resolution. If it is unspecified the current resolution setting is used. If a value is entered it should correspond to the current resolution setting otherwise an error occurs.	1 to 4 <sup>[b]</sup> 1.0, 0.1, 0.01, 0.001 <b>DEF</b> <sup>[a]</sup>
source list	The channel which the command is implemented on. If unspecified the current window setup is used. However, if the window shows a ratio or difference measurement, the upper window defaults to Channel A and the lower window to Channel B.	(@1) (@2)

[a] The mnemonic **DEF** means DEFault. This is not equivalent to the DEFault parameter used in the command sub-systems. The parameters must be entered in the specified order. If parameters are omitted, they default from the right. The parameter DEFault is used as a place holder. Specifying **DEF** leaves the parameter value unchanged.

[b] When the measurement result is linear this parameter represents the number of significant digits. When the measurement result is logarithmic 1 to 4 represents of 1, 0.1, 0.01 and 0.001 respectively.

## Example

**FETC2:POW:AC?**

*This command queries the lower window/  
upper measurement result.*

## Error Messages

- If the last measurement is not valid error –230, “Data corrupt or stale” occurs. A measurement is valid after it has been initiated. It becomes invalid when either a reset occurs or any measurement parameter, for example frequency, is changed.
- If the expected\_value and resolution parameters are not the same as the current expected value and resolution setting on the specified window, error –221, “Settings conflict” occurs.

FETCh[1]|2|3|4[:SCALar][:POWer:AC]:RELative?  
 [<expected\_value>[,<resolution>[,<source list>]]]

This command sets the specified window's measurement function to single channel with relative mode on, recalculates the measurement and places the results on the bus. The result is a ratio based measurement and is expressed in the units defined by **UNIT[1]|2|3|4:POWer:RATio**. The relative value used is that set by the **CALCulate:RELative:MAGNitude:AUTO** command.

### Syntax

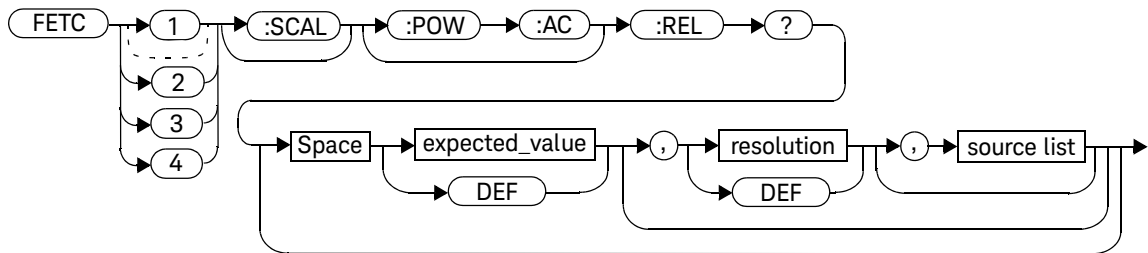

### Parameters

Refer to “Optional Parameters” on page 126 for additional details on the parameters in this command.

Item	Description/Default	Range of Values
expected_value (for the expected power level)	The expected power level parameter can be set to <b>DEF</b> or a numeric value. If a value is entered it should correspond to that set by <b>CONFigure</b> otherwise an error occurs. The units of measurement are dBm and W. The default units are defined by <b>UNIT:POWer</b> .	Sensor dependent <b>DEF</b> <sup>[a]</sup>

Item	Description/Default	Range of Values
resolution	A numeric value for the resolution. If it is unspecified the current resolution setting is used. If a value is entered it should correspond to the current resolution setting otherwise an error occurs.	1 to 4 <sup>[b]</sup> 1.0, 0.1, 0.01, 0.001 <b>DEF</b> <sup>[a]</sup>
source list	The channel which the command is implemented on. If unspecified the current window setup is used. However, if the window shows a ratio or difference measurement, the upper window defaults to Channel A and the lower window to Channel B.	(@1) (@2)

[a] The mnemonic **DEF** means DEFault. This is not equivalent to the DEFault parameter used in the command sub-systems. The parameters must be entered in the specified order. If parameters are omitted, they default from the right. The parameter DEFault is used as a place holder. Specifying **DEF** leaves the parameter value unchanged.

[b] When the measurement result is linear this parameter represents the number of significant digits. When the measurement result is logarithmic 1 to 4 represents of 1, 0.1, 0.01 and 0.001 respectively.

## Example

**FETC1:REL? DEF,2,(@2)**

*This command queries the upper window/ upper measurement relative measurement of Channel B, using the current sensor range and a resolution setting of 2.*

## Error Messages

- If the last measurement is not valid error –230, “Data corrupt or stale” occurs. A measurement is valid after it has been initiated. It becomes invalid when either a reset occurs or any measurement parameter, for example frequency, is changed.
- If the expected\_value and resolution parameters are not the same as the current expected value and resolution settings on the specified window, error –221, “Settings conflict” occurs.

FETCh[1]|2|3|4[:SCALar][:POWer:AC]:DIFFerence?  
 [<expected\_value>[,<resolution>[,<source list>]]]

This command sets the specified window's measurement function to power difference with relative mode off, recalculates the measurement and places the results on the bus. The result is a power based measurement and is expressed in the units defined by **UNIT[1]|2|3|4:POWer**.

### Syntax

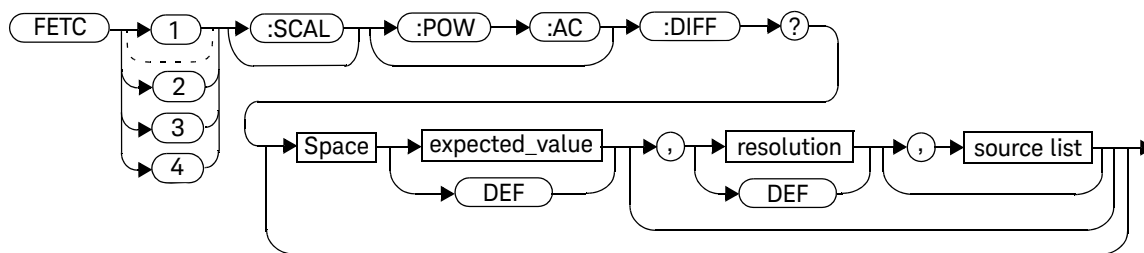

### Parameters

Refer to “**Optional Parameters**” on page 126 for additional details on the parameters in this command.

Item	Description/Default	Range of Values
expected_value (for the expected power level)	The expected power level parameter can be set to <b>DEF</b> or a numeric value. If a value is entered it should correspond to that set by <b>CONFigure</b> otherwise an error occurs. The units of measurement are dBm and W. The default units are defined by <b>UNIT:POWer</b> .	Sensor dependent <b>DEF</b> <sup>[a]</sup>

Item	Description/Default	Range of Values
resolution	A numeric value for the resolution. If it is unspecified the current resolution setting is used. If a value is entered it should correspond to the current resolution setting otherwise an error occurs.	1 to 4 <sup>[b]</sup> 1.0, 0.1, 0.01, 0.001 <b>DEF</b> <sup>[a]</sup>
source list	This channel list specifies the channels used to calculate the difference. If unspecified and the current window setup is a difference measurement then this difference setup is used, otherwise it defaults to Channel A-B.	(@1),(@2) (@2),(@1) (@1),(@1) (@2),(@2)

- [a] The mnemonic **DEF** means DEFault. This is not equivalent to the DEFault parameter used in the command sub-systems. The parameters must be entered in the specified order. If parameters are omitted, they default from the right. The parameter DEFault is used as a place holder. Specifying **DEF** leaves the parameter value unchanged.
- [b] When the measurement result is linear this parameter represents the number of significant digits. When the measurement result is logarithmic 1 to 4 represents of 1, 0.1, 0.01 and 0.001 respectively.

## Example

**FETC2:DIFF?**

*This command queries the difference measurement on the lower window/lower measurement.*

## Error Messages

- If the last measurement on either channel is not valid error –230, “Data corrupt or stale” occurs. A measurement is valid after it has been initiated. It becomes invalid when either a reset occurs or any measurement parameter, for example frequency, is changed.
- If the expected\_value and resolution parameters are not the same as the current expected value and resolution settings on the specified window, error –221, “Settings conflict” occurs.

# FETCh[1]|2|3|4[:SCALar][:POWer:AC]:DIFFerence: RELative? [<expected\_value>[,<resolution>[,<source list>]]]

This command sets the specified window's measurement function to power difference with relative mode on, recalculates the measurement and places the results on the bus. The result is a ratio based measurement and is expressed in the units defined by **UNIT[1]|2|3|4:POWer:RATio**. The relative value used is that set by the **CALCulate:RELative:MAGNitude:AUTO** command.

## Syntax

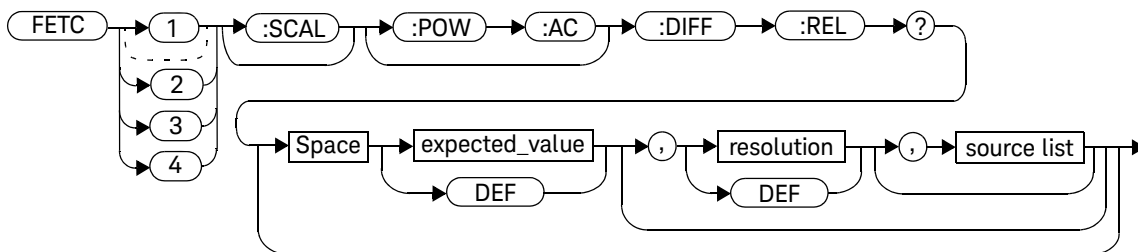

## Parameters

Refer to **“Optional Parameters”** on page 126 for additional details on the parameters in this command.

Item	Description/Default	Range of Values
expected_value (for the expected power level)	The expected power level parameter can be set to <b>DEF</b> or a numeric value. If a value is entered it should correspond to that set by <b>CONFigure</b> otherwise an error occurs. The units of measurement are dBm and W. The default units are defined by <b>UNIT:POWer</b> .	Sensor dependent <b>DEF</b> <sup>[a]</sup>



Item	Description/Default	Range of Values
resolution	A numeric value for the resolution. If it is unspecified the current resolution setting is used. If a value is entered it should correspond to the current resolution setting otherwise an error occurs.	1 to 4 <sup>[b]</sup> 1.0, 0.1, 0.01, 0.001 <b>DEF</b> <sup>[a]</sup>
source list	This channel list specifies the channels used to calculate the difference. If unspecified and the current window setup is a difference measurement then this difference setup is used, otherwise it defaults to Channel A-B.	(@1),(@2) (@2),(@1) (@1),(@1) (@2),(@2)

[a] The mnemonic **DEF** means DEFault. This is not equivalent to the DEFault parameter used in the command sub-systems. The parameters must be entered in the specified order. If parameters are omitted, they default from the right. The parameter DEFault is used as a place holder. Specifying **DEF** leaves the parameter value unchanged.

[b] When the measurement result is linear this parameter represents the number of significant digits. When the measurement result is logarithmic 1 to 4 represents of 1, 0.1, 0.01 and 0.001 respectively.

## Example

```
FETC1:DIFF:REL? DEF,3,
(@2),(@1)
```

*This command queries the upper window/ upper measurement relative difference measurement of Channel B - Channel A, using the current sensor range and a resolution setting of 3 on both channels.*

## Error Messages

- If the last measurement on either channel is not valid error –230, “Data corrupt or stale” occurs. A measurement is valid after it has been initiated. It becomes invalid when either a reset occurs or any measurement parameter, for example frequency, is changed.
- If the expected\_value and resolution parameters are not the same as the current expected value and resolution settings on the specified window, error –221, “Settings conflict” occurs.

```
FETCh[1]|2|3|4[:SCALar][:POWer:AC]:RATio?
[<expected_value>[,<resolution>[,<source list>]]]
```

This command sets the specified window's measurement function to power ratio with relative mode off, recalculates the measurement and places the results on the bus. The result is a ratio based measurement and is expressed in the units defined by **UNIT[1]|2|3|4:POWer:RATio**.

### Syntax

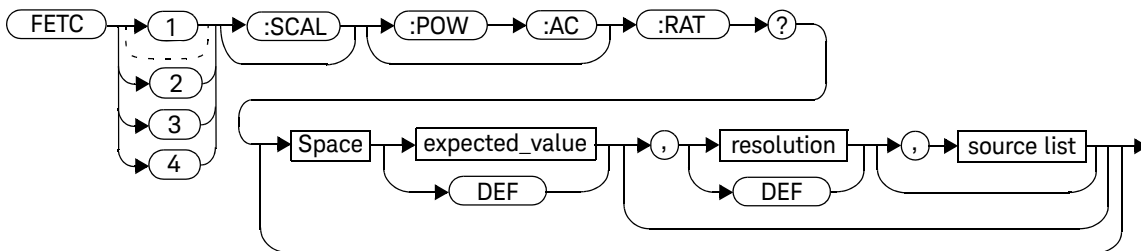

### Parameters

Refer to **“Optional Parameters”** on page 126 for additional details on the parameters in this command.

Item	Description/Default	Range of Values
expected_value (for the expected power level)	The expected power level parameter can be set to <b>DEF</b> or a numeric value. If a value is entered it should correspond to that set by <b>CONFigure</b> otherwise an error occurs. The units of measurement are dBm and W. The default units are defined by <b>UNIT:POWer</b> .	Sensor dependent <b>DEF</b> <sup>[a]</sup>

Item	Description/Default	Range of Values
resolution	A numeric value for the resolution. If it is unspecified the current resolution setting is used. If a value is entered it should correspond to the current resolution setting otherwise an error occurs.	1 to 4 <sup>[b]</sup> 1.0, 0.1, 0.01, 0.001 <b>DEF</b> <sup>[a]</sup>
source list	This channel list specifies the channels used to calculate the difference. If unspecified and the current window setup is a difference measurement then this difference setup is used, otherwise it defaults to Channel A-B.	(@1),(@2) (@2),(@1) (@1),(@1) (@2),(@2)

[a] The mnemonic **DEF** means DEFault. This is not equivalent to the DEFault parameter used in the command sub-systems. The parameters must be entered in the specified order. If parameters are omitted, they default from the right. The parameter DEFault is used as a place holder. Specifying **DEF** leaves the parameter value unchanged.

[b] When the measurement result is linear this parameter represents the number of significant digits. When the measurement result is logarithmic 1 to 4 represents of 1, 0.1, 0.01 and 0.001 respectively.

## Example

```
FETC2:RAT? DEF,1,(@1),(@2)
```

*This command queries the lower window/upper measurement ratio measurement of Channel A over Channel B, using the current sensor range and a resolution of 1 on both channels.*

## Error Messages

- If the last measurement on either channel is not valid error –230, “Data corrupt or stale” occurs. A measurement is valid after it has been initiated. It becomes invalid when either a reset occurs or any measurement parameter, for example frequency, is changed.
- If the expected\_value and resolution parameters are not the same as the current expected value and resolution settings on the specified window, error –221, “Settings conflict” occurs.

FETCh[1]|2|3|4[:SCALar][:POWer:AC]:RATio:RELative?  
 [<expected\_value>[,<resolution>[,<source list>]]]

This command sets the specified window's measurement function to power ratio with relative mode on, recalculates the measurement and places the results on the bus. The result is a ratio based measurement and is expressed in the units defined by **UNIT[1]|2|3|4:POWer:RATio**. The relative value used is that set by the **CALCulate:RELative:MAGNitude:AUTO** command.

Syntax

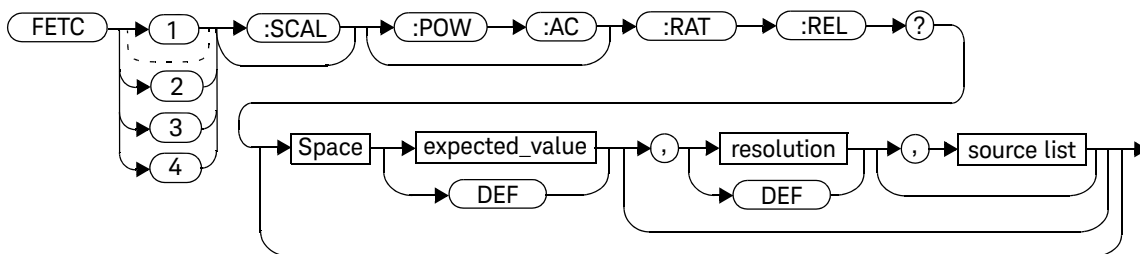

Parameters

Refer to **“Optional Parameters”** on page 126 for additional details on the parameters in this command.

Item	Description/Default	Range of Values
expected_value (for the expected power level)	The expected power level parameter can be set to <b>DEF</b> or a numeric value. If a value is entered it should correspond to that set by <b>CONFigure</b> otherwise an error occurs. The units of measurement are dBm and W. The default units are defined by <b>UNIT:POWer</b> .	Sensor dependent <b>DEF</b> <sup>[a]</sup>

Item	Description/Default	Range of Values
resolution	A numeric value for the resolution. If it is unspecified the current resolution setting is used. If a value is entered it should correspond to the current resolution setting otherwise an error occurs.	1 to 4 <sup>[b]</sup> 1.0, 0.1, 0.01, 0.001 <b>DEF</b> <sup>[a]</sup>
source list	This channel list specifies the channels used to calculate the difference. If unspecified and the current window setup is a difference measurement then this difference setup is used, otherwise it defaults to Channel A-B.	(@1),(@2) (@2),(@1) (@1),(@1) (@2),(@2)

- [a] The mnemonic **DEF** means DEFault. This is not equivalent to the DEFault parameter used in the command sub-systems. The parameters must be entered in the specified order. If parameters are omitted, they default from the right. The parameter DEFault is used as a place holder. Specifying **DEF** leaves the parameter value unchanged.
- [b] When the measurement result is linear this parameter represents the number of significant digits. When the measurement result is logarithmic 1 to 4 represents of 1, 0.1, 0.01 and 0.001 respectively.

## Example

**FETC:RAT:REL?**

*This command queries the relative ratio measurement on the upper window/upper measurement.*

## Error Messages

- If the last measurement on either channel is not valid error –230, “Data corrupt or stale” occurs. A measurement is valid after it has been initiated. It becomes invalid when either a reset occurs or any measurement parameter, for example frequency, is changed.
- If the expected\_value and resolution parameters are not the same as the current expected value and resolution settings on the specified window, error –221, “Settings conflict” occurs.

## READ[1]|2|3|4 Commands

The **READ?** commands are most commonly used with the **CONFigure** command to cause a new power measurement to be taken and the result returned to the output buffer. The format of the result is set by **FORM[:READ][:DATA]**. Refer to [Chapter 6](#), “FORMat Subsystem,” on page 275 for further information.

- For the N8262A carrying out a single channel measurement the **READ?** queries are equivalent to:

```
ABORt1
INITiate1
FETCh1?
```

*or*

```
ABORt2
INITiate2
FETCh2?
```

- For the N8262A carrying out a difference measurement the **READ:DIFFerence?** queries are equivalent to:

```
ABORt1
and
ABORt2
INITiate1
INITiate2
FETCh:DIFFerence?
```

- For the N8262A carrying out a ratio measurement the **READ:RATio?** queries are equivalent to:

```
ABORt1
ABORt2
INITiate1
INITiate2
FETCh:RATio?
```

READ[1]|2|3|4[:SCALar][:POWER:AC]?  
 [<expected\_value>[,<resolution>[,<source list>]]]

This command sets the specified window's measurement function to single channel with relative mode off, aborts then initiates the specified channel, calculates the measurement result and places the result on the bus. The result is a power based measurement and is expressed in the units defined by UNIT[1]|2|3|4:POWER.

#### NOTE

INITiate:CONTinuous must be set to OFF, otherwise error -213, "INIT ignored" occurs. If TRIGger:SOURce is set to BUS, error -214, "Trigger deadlock" occurs.

#### Syntax

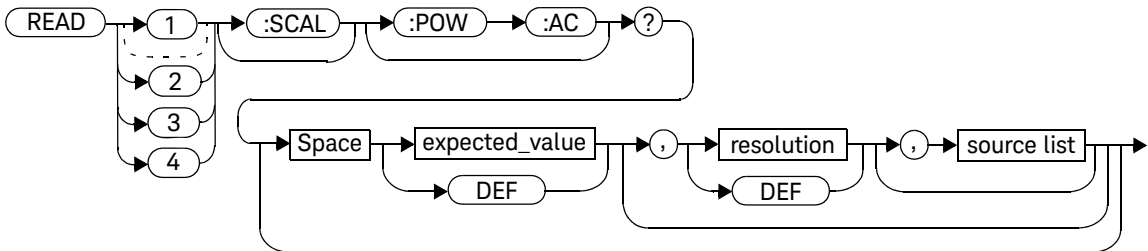

#### Parameters

Refer to [“Optional Parameters”](#) on page 126 for additional details on the parameters in this command.

Item	Description/Default	Range of Values
expected_value (for the expected power level)	The expected power level parameter can be set to <b>DEF</b> or a numeric value. If a value is entered it should correspond to that set by <b>CONF</b> igure otherwise an error occurs.	Sensor dependent <b>DEF</b> <sup>[a]</sup>
resolution	A numeric value for the resolution. If it is unspecified the current resolution setting is used. If a value is entered it should correspond to the current resolution setting otherwise an error occurs.	1 to 4 <sup>[b]</sup> 1.0, 0.1, 0.01, 0.001 <b>DEF</b> <sup>[a]</sup>
source list	The channel which the command is implemented on. If unspecified the current window setup is used. However, if the window shows a ratio or difference measurement, the upper window defaults to Channel A and the lower window to Channel B.	(@1) (@2)

[a] The mnemonic **DEF** means DEFault. This is not equivalent to the DEFault parameter used in the command sub-systems. The parameters must be entered in the specified order. If parameters are omitted, they default from the right. The parameter DEFault is used as a place holder. Specifying **DEF** leaves the parameter value unchanged.

[b] When the measurement result is linear this parameter represents the number of significant digits. When the measurement result is logarithmic 1 to 4 represents of 1, 0.1, 0.01 and 0.001 respectively.

## Example

**READ2:POW:AC?**

*This command queries the lower window/  
upper measurement.*

## Error Messages

- **INITiate:CONTInuous** must be set to **OFF**, otherwise error –213, “INIT ignored” occurs.
- If **TRIGger:SOURce** is set to **BUS** or **HOLD**, error –214, “Trigger deadlock” occurs.
- If the expected value and resolution parameters are not the same as the current expected value and resolution settings on the specified window, error –221, “Settings conflict” occurs.



READ[1]|2|3|4[:SCALar][:POWer:AC]:RELative?  
 [<expected\_value>[,<resolution>[,<source list>]]]

This command sets the specified window's measurement function to single channel with relative mode on, aborts then initiates the specified channel, calculates the measurement result and places the result on the bus. The result is a ratio based measurement and is expressed in the units defined by **UNIT[1]|2|3|4:POWer:RATio**. The relative value used is that set by the **CALCulate:RELative:MAGNitude:AUTO** command.

**NOTE**

**INITiate:CONTinuous** must be set to OFF, otherwise error -213, "INIT ignored" occurs. If **TRIGger:SOURce** is set to BUS, error -214, "Trigger deadlock" occurs.

## Syntax

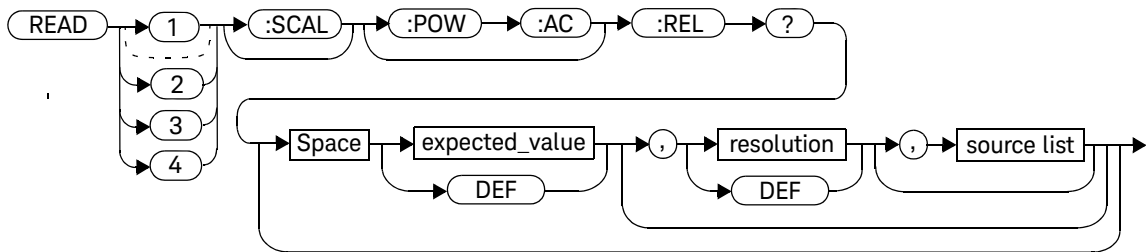

## Parameters

Refer to [“Optional Parameters”](#) on page 126 for additional details on the parameters in this command.

Item	Description/Default	Range of Values
expected_value (for the expected power level)	The expected power level parameter can be set to <b>DEF</b> or a numeric value. If a value is entered it should correspond to that set by <b>CONFigure</b> otherwise an error occurs.	Sensor dependent <b>DEF</b> <sup>[a]</sup>
resolution	A numeric value for the resolution. If it is unspecified the current resolution setting is used. If a value is entered it should correspond to the current resolution setting otherwise an error occurs.	1 to 4 <sup>[b]</sup> 1.0, 0.1, 0.01, 0.001 <b>DEF</b> <sup>[a]</sup>
source list	The channel which the command is implemented on. If unspecified the current window setup is used. However, if the window shows a ratio or difference measurement, the upper window defaults to Channel A and the lower window to Channel B.	(@1) (@2)

[a] The mnemonic **DEF** means DEFault. This is not equivalent to the DEFault parameter used in the command sub-systems. The parameters must be entered in the specified order. If parameters are omitted, they default from the right. The parameter DEFault is used as a place holder. Specifying **DEF** leaves the parameter value unchanged.

[b] When the measurement result is linear this parameter represents the number of significant digits. When the measurement result is logarithmic 1 to 4 represents of 1, 0.1, 0.01 and 0.001 respectively.

## Example

```
READ1:REL? DEF,1,(@2)
```

*This command queries the upper window/ upper measurement relative measurement of Channel B, using the current sensor range and a resolution of 1.*

## Error Messages

- **INITiate:CONTInuous** must be set to **OFF**, otherwise error -213, “INIT ignored” occurs.
- If **TRIGger:SOURce** is set to **BUS** or **HOLD**, error -214, “Trigger deadlock” occurs.
- If the expected value and resolution parameters are not the same as the current expected value and resolution settings on the specified window, error -221, “Settings conflict” occurs.

## READ[1]|2|3|4[:SCALar][:POWer:AC]:DIFFerence? [<expected\_value>[,<resolution>[,<source list>]]]

This command sets the specified window's measurement function to difference mode with relative mode off, aborts then initiates both Channel A and B, calculates the difference measurement result and places the result on the bus. The result is a power based measurement and is expressed in the units defined by `UNIT[1]|2|3|4:POWer`.

### NOTE

`INITiate:CONTinuous` must be set to `OFF` on both channels, otherwise error -213, "INIT ignored" occurs. If `TRIGger:SOURce` is set to `BUS` on either channel, error -214, "Trigger deadlock" occurs.

### Syntax

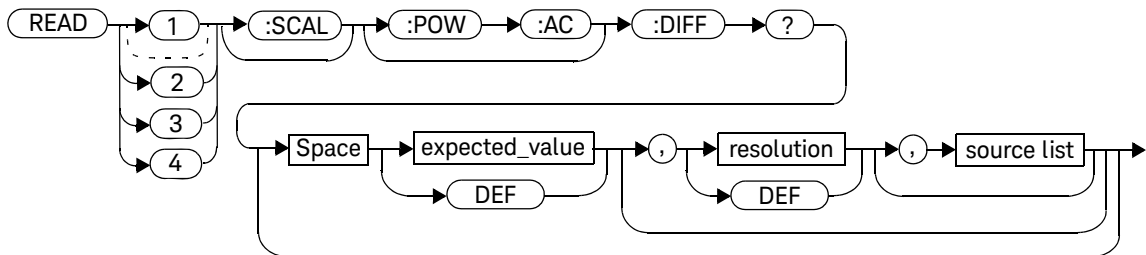

### Parameters

Refer to [“Optional Parameters”](#) on page 126 for additional details on the parameters in this command.

Item	Description/Default	Range of Values
expected_value (for the expected power level)	The power meter ignores the numeric value entered in this parameter. Any value entered is treated like <b>DEF</b> .	Sensor dependent <b>DEF</b> <sup>[a]</sup>
resolution	A numeric value for the resolution. If it is unspecified the current resolution setting is used. If a value is entered it should correspond to the current resolution setting otherwise an error occurs.	1 to 4 <sup>[b]</sup> 1.0, 0.1, 0.01, 0.001 <b>DEF</b> <sup>[a]</sup>
source list	This channel list specifies the channels used to calculate the difference. If unspecified and the current window setup is a difference measurement then this difference setup is used, otherwise it defaults to Channel A-B.	(@1),(@2) (@2),(@1) (@1),(@1) (@2),(@2)

[a] The mnemonic **DEF** means DEFault. This is not equivalent to the DEFault parameter used in the command sub-systems. The parameters must be entered in the specified order. If parameters are omitted, they default from the right. The parameter DEFault is used as a place holder. Specifying **DEF** leaves the parameter value unchanged.

[b] When the measurement result is linear this parameter represents the number of significant digits. When the measurement result is logarithmic 1 to 4 represents of 1, 0.1, 0.01 and 0.001 respectively.

## Example

**READ2:DIFF?**

*This command queries difference measurement on the lower window/upper measurement.*

## Error Messages

- **INITiate:CONTinuous** must be set to **OFF** on both channels, otherwise error –213, “INIT ignored” occurs.
- If **TRIGger:SOURce** is set to **BUS** or **HOLD** on either channel, error –214, “Trigger deadlock” occurs.
- If the resolution parameter is not the same as the current resolution setting on the specified window, error –221, “Settings conflict” occurs.

READ[1]|2|3|4[:SCALAR][:POWER:AC]:DIFFERENCE:  
RELATIVE? [<expected\_value>[,<resolution>[,<source list>]]]

This command sets the specified window's measurement function to difference mode with relative mode on, aborts then initiates both Channel A and B, calculates the difference measurement result and places the result on the bus. The result is a ratio based measurement and is expressed in the units defined by UNIT[1]|2|3|4:POWER:RATIO. The relative value used is that set by the CALCULATE:RELATIVE:MAGNITUDE:AUTO command.

**NOTE**

INITiate:CONTinuous must be set to OFF on both channels, otherwise error -213, "INIT ignored" occurs. If TRIGger:SOURce is set to BUS on either channel, error -214, "Trigger deadlock" occurs.

## Syntax

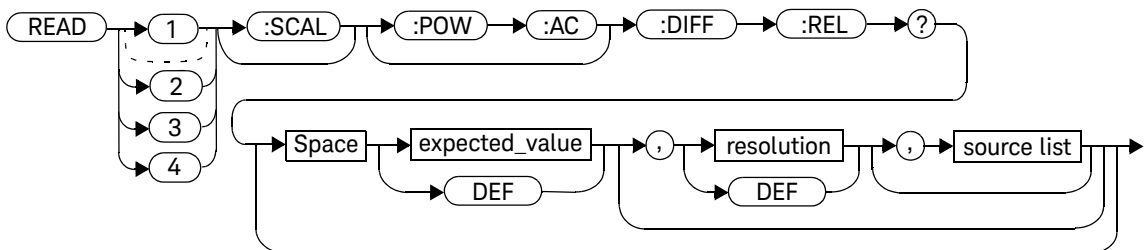

## Parameters

Refer to ["Optional Parameters"](#) on page 126 for additional details on the parameters in this command.

Item	Description/Default	Range of Values
expected_value (for the expected power level)	The power meter ignores the numeric value entered in this parameter. Any value entered is treated like <b>DEF</b> .	Sensor dependent <b>DEF</b> <sup>[a]</sup>
resolution	A numeric value for the resolution. If it is unspecified the current resolution setting is used. If a value is entered it should correspond to the current resolution setting otherwise an error occurs.	1 to 4 <sup>[b]</sup> 1.0, 0.1, 0.01, 0.001 <b>DEF</b> <sup>[a]</sup>
source list	This channel list specifies the channels used to calculate the difference. If unspecified and the current window setup is a difference measurement then this difference setup is used, otherwise it defaults to Channel A-B.	(@1),(@2) (@2),(@1) (@1),(@1) (@2),(@2)

[a] The mnemonic **DEF** means DEFault. This is not equivalent to the DEFault parameter used in the command sub-systems. The parameters must be entered in the specified order. If parameters are omitted, they default from the right. The parameter DEFault is used as a place holder. Specifying **DEF** leaves the parameter value unchanged.

[b] When the measurement result is linear this parameter represents the number of significant digits. When the measurement result is logarithmic 1 to 4 represents of 1, 0.1, 0.01 and 0.001 respectively.

## Example

```
READ1:DIFF:REL? DEF,4,(@2),(@1)
```

*This command queries the upper window/upper measurement relative difference measurement of Channel B - Channel A, using the current sensor range and a resolution setting of 4 on both channels.*

## Error Messages

- **INITiate:CONTinuous** must be set to **OFF** on both channels, otherwise error -213, “INIT ignored” occurs.
- If **TRIGger:SOURce** is set to **BUS** or **HOLD** on either channel, error -214, “Trigger deadlock” occurs.
- If the resolution parameter is not the same as the current resolution setting on the specified window, error -221, “Settings conflict” occurs.

READ[1]|2|3|4[:SCALar][:POWer:AC]:RATio?  
 [<expected\_value>[,<resolution>[,<source list>]]]

This command sets the specified window's measurement function to ratio mode with relative mode off, aborts then initiates both Channel A and B, calculates the ratio measurement result and places the result on the bus. The result is a ratio based measurement and is expressed in the units defined by **UNIT[1]|2|3|4:POWer:RATio**.

#### NOTE

INITiate:CON Tinuous must be set to OFF on both channels, otherwise error -213, "INIT ignored" occurs. If TRIGger:SOURce is set to BUS on either channel, error -214, "Trigger deadlock" occurs.

#### Syntax

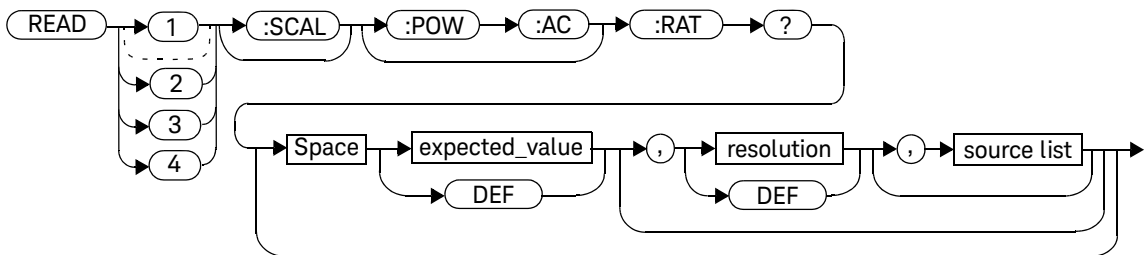

#### Parameters

Refer to [“Optional Parameters”](#) on page 126 for additional details on the parameters in this command.

Item	Description/Default	Range of Values
expected_value (for the expected power level)	The power meter ignores the numeric value entered in this parameter. Any value entered is treated like <b>DEF</b> .	Sensor dependent <b>DEF</b> <sup>[a]</sup>
resolution	A numeric value for the resolution. If it is unspecified the current resolution setting is used. If a value is entered it should correspond to the current resolution setting otherwise an error occurs.	1 to 4 <sup>[b]</sup> 1.0, 0.1, 0.01, 0.001 <b>DEF</b> <sup>[a]</sup>
source list	This channel list specifies the channels used to calculate the difference. If unspecified and the current window setup is a difference measurement then this difference setup is used, otherwise it defaults to Channel A-B.	(@1),(@2) (@2),(@1) (@1),(@1) (@2),(@2)

[a] The mnemonic **DEF** means DEFault. This is not equivalent to the DEFault parameter used in the command sub-systems. The parameters must be entered in the specified order. If parameters are omitted, they default from the right. The parameter DEFault is used as a place holder. Specifying **DEF** leaves the parameter value unchanged.

[b] When the measurement result is linear this parameter represents the number of significant digits. When the measurement result is logarithmic 1 to 4 represents of 1, 0.1, 0.01 and 0.001 respectively.

## Example

```
READ2:RAT? DEF,1,(@1),(@2)
```

*This command queries the lower window/ upper measurement ratio measurement of Channel A over Channel B, using the current sensor range and a resolution of 1 on both channels.*

## Error Messages

- **INITiate:CONTinuous** must be set to **OFF** on both channels, otherwise error –213, “INIT ignored” occurs.
- If **TRIGger:SOURce** is set to **BUS** or **HOLD** on either channel, error –214, “Trigger deadlock” occurs.
- If the resolution parameter is not the same as the current resolution setting on the specified window, error –221, “Settings conflict” occurs.



READ[1]|2|3|4[:SCALar][:POWer:AC]:RATio:RELative?  
 [<expected\_value>[,<resolution>[,<source list>]]]

This command sets the specified window's measurement function to ratio mode with relative mode on, aborts then initiates both Channel A and B, calculates the ratio measurement result using the new sensor data and places the result on the bus. The result is a ratio based measurement and is expressed in the units defined by `UNIT[1]|2|3|4:POWer:RATio`. The relative value used is that set by the `CALCulate:RELative:MAGNitude:AUTO` command.

#### NOTE

IIINITiate:CONTinuous must be set to OFF on both channels, otherwise error -213, "INIT ignored" occurs. If TRIGger:SOURce is set to BUS on either channel, error -214, "Trigger deadlock" occurs.

#### Syntax

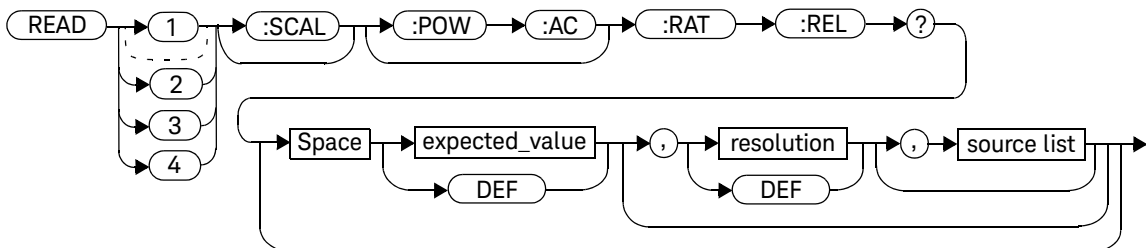

#### Parameters

Refer to [“Optional Parameters”](#) on page 126 for additional details on the parameters in this command.

Item	Description/Default	Range of Values
expected_value (for the expected power level)	The power meter ignores the numeric value entered in this parameter. Any value entered is treated like <b>DEF</b> .	Sensor dependent <b>DEF</b> <sup>[a]</sup>
resolution	A numeric value for the resolution. If it is unspecified the current resolution setting is used. If a value is entered it should correspond to the current resolution setting otherwise an error occurs.	1 to 4 <sup>[b]</sup> 1.0, 0.1, 0.01, 0.001 <b>DEF</b> <sup>[a]</sup>
source list	This channel list specifies the channels used to calculate the difference. If unspecified and the current window setup is a difference measurement then this difference setup is used, otherwise it defaults to Channel A-B.	(@1),(@2) (@2),(@1) (@1),(@1) (@2),(@2)

[a] The mnemonic **DEF** means DEFault. This is not equivalent to the DEFault parameter used in the command sub-systems. The parameters must be entered in the specified order. If parameters are omitted, they default from the right. The parameter DEFault is used as a place holder. Specifying **DEF** leaves the parameter value unchanged.

[b] When the measurement result is linear this parameter represents the number of significant digits. When the measurement result is logarithmic 1 to 4 represents of 1, 0.1, 0.01 and 0.001 respectively.

## Example

**READ:RAT:REL?**

*This command queries the relative ratio measurement on the upper window/upper measurement.*

## Error Messages

- **INITiate:CONTInuous** must be set to **OFF** on both channels, otherwise error –213, “INIT ignored” occurs.
- If **TRIGger:SOURce** is set to **BUS** or **HOLD** on either channel, error –214, “Trigger deadlock” occurs.
- If the resolution parameter is not the same as the current resolution setting on the specified window, error –221, “Settings conflict” occurs.

## MEASure[1]|2|3|4 Commands

The **MEASure?** commands configure the power meter to perform a power measurement with the given measurement function, relative mode setting, range and resolution then makes the measurement. The format of the result is set by **FORM[:READ][:DATA]**. Refer to [Chapter 6](#), “FORMat Subsystem,” on page 275 for further information.

**MEASure?** is a compound command which is equivalent to:

- For the N8262A carrying out a single channel measurement the **MEASure?** queries are equivalent to:

```
ABORt1
CONFigure
READ1?
```

*or*

```
ABORt2
CONFigure
READ2?
```

- For the N8262A carrying out a difference measurement the **READ:DIFFerence?** queries are equivalent to:

```
ABORt1
ABORt2
CONFigure:DIFFerence
READ:DIFFerence?
```

- For the N8262A carrying out a ratio measurement the **READ:RATio?** queries are equivalent to:

```
ABORt1
ABORt2
CONFigure:RATio
READ:RATio?
```

MEASure[1]|2|3|4[:SCALar][:POWer:AC]?  
 [<expected\_value>[,<resolution>[,<source list>]]]

This command sets the specified window's measurement function to single channel with relative mode off, aborts, configures the window then initiates Channel A or B, calculates the measurement result and places the result on the bus.

### Syntax

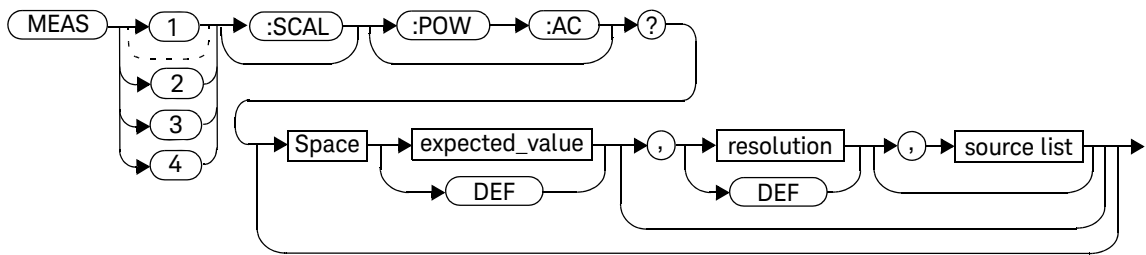

### Parameters

Refer to “[Optional Parameters](#)” on page 126 for additional details on the parameters in this command.

Item	Description/Default	Range of Values
expected_value (for the expected power level)	A numeric value for the expected power level. The units of measurement are dBm and W. The default units are defined by <b>UNIT:POWer</b> .	Sensor dependent DEF <sup>[a]</sup>
resolution	A numeric value for the resolution. If unspecified the current resolution setting is used.	1 to 4 <sup>[b]</sup> 1.0, 0.1, 0.01, 0.001 DEF <sup>[a]</sup>
source list	The channel which the command is implemented on. If unspecified the current window setup is used. However, if the window shows a ratio or difference measurement, the upper window defaults to Channel A and the lower window to Channel B.	(@1) (@2)

- [a] The mnemonic **DEF** means DEFault. This is not equivalent to the DEFault parameter used in the command sub-systems. The parameters must be entered in the specified order. If parameters are omitted, they default from the right. The parameter DEFault is used as a place holder. Specifying **DEF** leaves the parameter value unchanged.
- [b] When the measurement result is linear this parameter represents the number of significant digits. When the measurement result is logarithmic 1 to 4 represents of 1, 0.1, 0.01 and 0.001 respectively.

## Example

**MEAS2:POW:AC? -70DBM,1,(@1)** *This command queries the lower window/upper measurement of Channel A, using an expected power level of -70 dBm and a resolution setting of 1.*

# MEASure[1]|2|3|4[:SCALar][:POWER:AC]:RELative? [<expected\_value>[,<resolution>[,<source list>]]]

This command sets the specified window's measurement function to single channel with relative mode on, aborts, configures then initiates the specified channel, calculates the measurement result and places the result on the bus. The result is a ratio based measurement and is expressed in the units defined by **UNIT[1]|2|3|4:Power:Ratio**. The relative value used is that set by the **CALCulate:RELative:MAGNitude:AUTO** command.

## Syntax

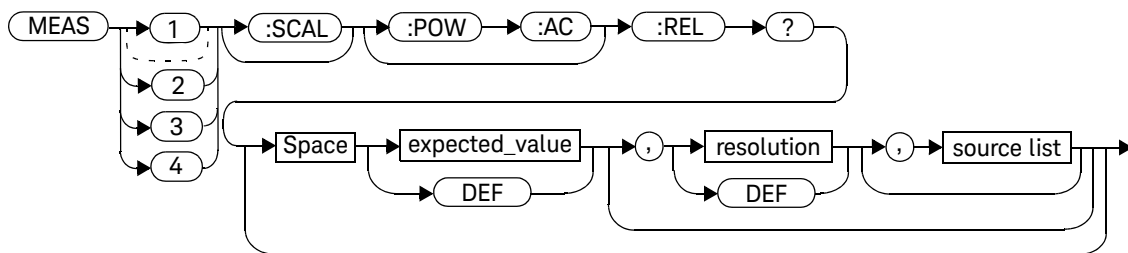

## Parameters

Refer to **“Optional Parameters”** on page 126 for additional details on the parameters in this command.

Item	Description/Default	Range of Values
expected_value (for the expected power level)	A numeric value for the expected power level. The units of measurement are dBm and W. The default units are defined by <b>UNIT:Power</b> .	Sensor dependent <b>DEF</b> <sup>[a]</sup>

Item	Description/Default	Range of Values
resolution	A numeric value for the resolution. If unspecified the current resolution setting is used.	1 to 4 <sup>[b]</sup> 1.0, 0.1, 0.01, 0.001 <b>DEF</b> <sup>[a]</sup>
source list	The channel which the command is implemented on. If unspecified the current window setup is used. However, if the window shows a ratio or difference measurement, the upper window defaults to Channel A and the lower window to Channel B.	(@1) (@2)

[a] The mnemonic **DEF** means DEFault. This is not equivalent to the DEFault parameter used in the command sub-systems. The parameters must be entered in the specified order. If parameters are omitted, they default from the right. The parameter DEFault is used as a place holder. Specifying **DEF** leaves the parameter value unchanged.

[b] When the measurement result is linear this parameter represents the number of significant digits. When the measurement result is logarithmic 1 to 4 represents of 1, 0.1, 0.01 and 0.001 respectively.

## Example

**MEAS1:REL? -50DBM,2,(@2)**

*This command queries the upper window/ upper measurement relative measurement of Channel B, using an expected power level of -50 dBm and a resolution setting of 2.*

## MEASure[1]|2|3|4[:SCALar][:POWer:AC]:DIFFerence? [<expected\_value>[,<resolution>[,<source list>]]]

This command sets the specified window's measurement function to difference mode with relative mode off, aborts, configures then initiates both Channel A and B, calculates the difference measurement result and places the result on the bus. The result is a power based measurement and is expressed in the units defined by **UNIT[1]|2|3|4:POWer**.

### Syntax

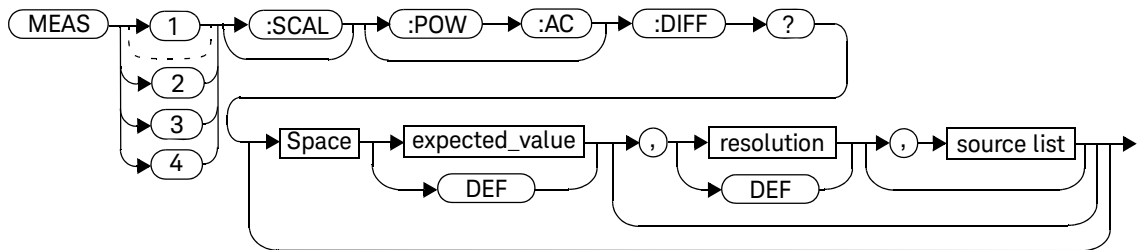

### Parameters

Refer to “[Optional Parameters](#)” on page 126 for additional details on the parameters in this command.

Item	Description/Default	Range of Values
expected_value (for the expected power level)	The power meter ignores the numeric value entered in this parameter. Any value entered is treated like <b>DEF</b> .	Sensor dependent <b>DEF</b> <sup>[a]</sup>



Item	Description/Default	Range of Values
resolution	A numeric value for the resolution. If unspecified the current resolution setting is used.	1 to 4 <sup>[b]</sup> 1.0, 0.1, 0.01, 0.001 DEF <sup>[a]</sup>
source list	This channel list specifies the channels used to calculate the difference. If unspecified and the current window setup is a difference measurement then this difference setup is used, otherwise it defaults to Channel A-B.	(@1),(@2) (@2),(@1) (@1),(@1) (@2),(@2)

[a] The mnemonic DEF means DEFault. This is not equivalent to the DEFault parameter used in the command sub-systems. The parameters must be entered in the specified order. If parameters are omitted, they default from the right. The parameter DEFault is used as a place holder. Specifying DEF leaves the parameter value unchanged.

[b] When the measurement result is linear this parameter represents the number of significant digits. When the measurement result is logarithmic 1 to 4 represents of 1, 0.1, 0.01 and 0.001 respectively.

## Example

**MEAS2:DIFF?**

*This command queries the difference measurement on the lower window/ upper measurement.*

MEASure[1]|2|3|4[:SCALar][:POWER:AC]:DIFFerence:  
RELative? [[expected\\_value](#)][[resolution](#)][[source list](#)]]

This command sets the specified window's measurement function to difference mode with relative mode on, aborts, configures then initiates both Channel A and B, calculates the difference measurement result and places the result on the bus. The result is a ratio based measurement and is expressed in the units defined by `UNIT[1]|2|3|4:POWER:RATio`. The relative value used is that set by the `CALCulate:RELative:MAGNitude:AUTO` command.

### Syntax

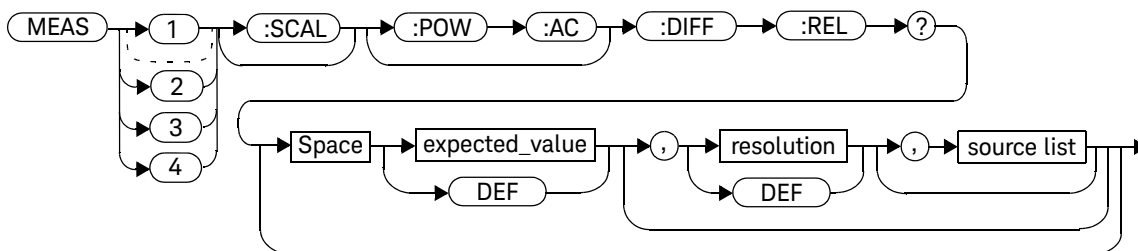

### Parameters

Refer to [“Optional Parameters”](#) on page 126 for additional details on the parameters in this command.

Item	Description/Default	Range of Values
expected_value (for the expected power level)	The power meter ignores the numeric value entered in this parameter. Any value entered is treated like <code>DEF</code> .	Sensor dependent <code>DEF</code> <sup>[a]</sup>

Item	Description/Default	Range of Values
resolution	A numeric value for the resolution. If unspecified the current resolution setting is used.	1 to 4 <sup>[b]</sup> 1.0, 0.1, 0.01, 0.001 <b>DEF</b> <sup>[a]</sup>
source list	This channel list specifies the channels used to calculate the difference. If unspecified and the current window setup is a difference measurement then this difference setup is used, otherwise it defaults to Channel A-B.	(@1),(@2) (@2),(@1) (@1),(@1) (@2),(@2)

[a] The mnemonic **DEF** means DEFault. This is not equivalent to the DEFault parameter used in the command sub-systems. The parameters must be entered in the specified order. If parameters are omitted, they default from the right. The parameter DEFault is used as a place holder. Specifying **DEF** leaves the parameter value unchanged.

[b] When the measurement result is linear this parameter represents the number of significant digits. When the measurement result is logarithmic 1 to 4 represents of 1, 0.1, 0.01 and 0.001 respectively.

## Example

```
MEAS1:DIFF:REL? DEF,3,
(@2),(@1)
```

*This command queries the upper window/ upper measurement relative difference measurement of Channel B - Channel A, using the current sensor range and a resolution setting of 3 on both channels.*

MEASure[1]|2|3|4[:SCALar][:POWer:AC]:RATio?  
 [<expected\_value>[,<resolution>[,<source list>]]]

This command sets the specified window's measurement function to ratio mode with relative mode off, aborts, configures then initiates both Channel A and B, calculates the ratio measurement result and places the result on the bus. The result is a ratio based measurement and is expressed in the units defined by **UNIT[1]|2|3|4:POWer:RATio**.

### Syntax

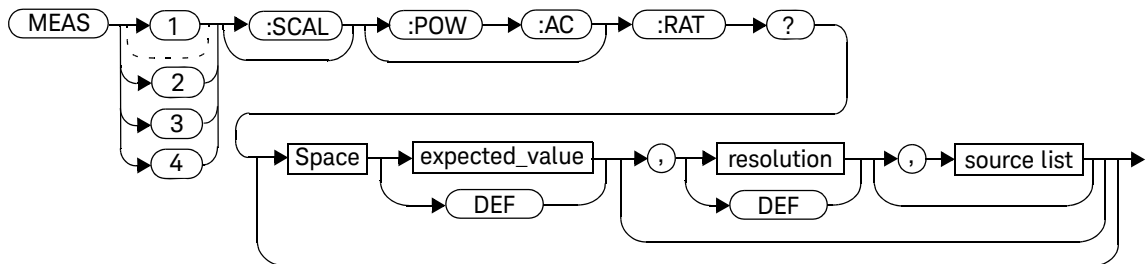

### Parameters

Refer to “[Optional Parameters](#)” on page 126 for additional details on the parameters in this command.

Item	Description/Default	Range of Values
expected_value (for the expected power level)	The power meter ignores the numeric value entered in this parameter. Any value entered is treated like <b>DEF</b> .	Sensor dependent <b>DEF</b> <sup>[a]</sup>

Item	Description/Default	Range of Values
resolution	A numeric value for the resolution. If unspecified the current resolution setting is used.	1 to 4 <sup>[b]</sup> 1.0, 0.1, 0.01, 0.001 <b>DEF</b> <sup>[a]</sup>
source list	This channel list specifies the channels used to calculate the difference. If unspecified and the current window setup is a difference measurement then this difference setup is used, otherwise it defaults to Channel A-B.	(@1),(@2) (@2),(@1) (@1),(@1) (@2),(@2)

[a] The mnemonic **DEF** means DEFault. This is not equivalent to the DEFault parameter used in the command sub-systems. The parameters must be entered in the specified order. If parameters are omitted, they default from the right. The parameter DEFault is used as a place holder. Specifying **DEF** leaves the parameter value unchanged.

[b] When the measurement result is linear this parameter represents the number of significant digits. When the measurement result is logarithmic 1 to 4 represents of 1, 0.1, 0.01 and 0.001 respectively.

## Example

```
MEAS2:RAT? DEF,1,(@1),(@2)
```

*This command queries the lower window/upper measurement ratio measurement of Channel A over Channel B, using the current sensor range and a resolution of 1 on both channels.*

# MEASure[1]|2|3|4[:SCALar][:POWER:AC]:RATio:RELative? [<expected\_value>[,<resolution>[,<source list>]]]

This command sets the specified window's measurement function to ratio mode with relative mode on, aborts, configures then initiates both Channel A and B, calculates the ratio measurement and places the result on the bus. The result is a ratio based measurement and is expressed in the units defined by **UNIT[1]|2|3|4:POWER:RATio**. The relative value used is that set by the **CALCulate:RELative:MAGNitude:AUTO** command.

## Syntax

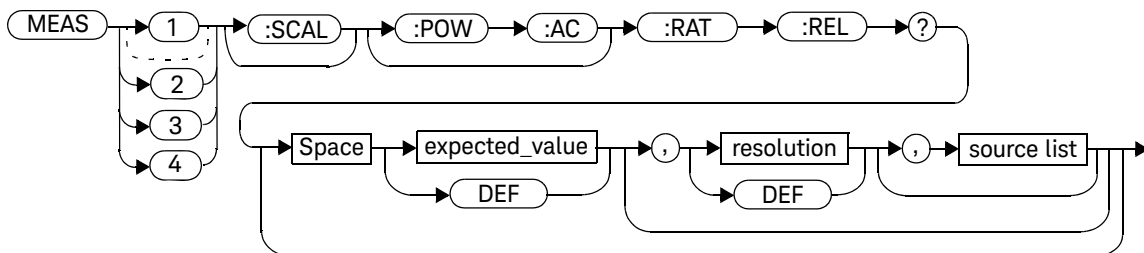

## Parameters

Refer to **“Optional Parameters”** on page 126 for additional details on the parameters in this command.

Item	Description/Default	Range of Values
expected_value (for the expected power level)	The power meter ignores the numeric value entered in this parameter. Any value entered is treated like <b>DEF</b> .	Sensor dependent <b>DEF</b> <sup>[a]</sup>

Item	Description/Default	Range of Values
resolution	A numeric value for the resolution. If unspecified the current resolution setting is used.	1 to 4 <sup>[b]</sup> 1.0, 0.1, 0.01, 0.001 <b>DEF</b> <sup>[a]</sup>
source list	This channel list specifies the channels used to calculate the difference. If unspecified and the current window setup is a difference measurement then this difference setup is used, otherwise it defaults to Channel A-B.	(@1),(@2) (@2),(@1) (@1),(@1) (@2),(@2)

[a] The mnemonic DEF means DEFault. This is not equivalent to the DEFault parameter used in the command sub-systems. The parameters must be entered in the specified order. If parameters are omitted, they default from the right. The parameter DEFault is used as a place holder. Specifying DEF leaves the parameter value unchanged.

[b] When the measurement result is linear this parameter represents the number of significant digits. When the measurement result is logarithmic 1 to 4 represents of 1, 0.1, 0.01 and 0.001 respectively.

## Example

**MEAS:RAT:REL?**

*This command queries the relative ratio measurement on the upper window/upper measurement.*

THIS PAGE HAS BEEN INTENTIONALLY LEFT BLANK.



# 3 CALCulate Subsystem

CALCulate Subsystem	186
CALCulate[1]2 3 4:FEED[1]2 <string>	189
CALCulate[1]2 3 4:GAIN Commands	192
CALCulate[1]2 3 4:GAIN[:MAGNitude] <numeric_value>	193
CALCulate[1]2 3 4:GAIN:STATe <boolean>	195
CALCulate[1]2 3 4:LIMit Commands	197
CALCulate[1]2 3 4:LIMit:CLEar:AUTO <boolean> ONCE	198
CALCulate[1]2 3 4:LIMit:CLEar[:IMMEDIATE]	200
CALCulate[1]2 3 4:LIMit:FAIL?	201
CALCulate[1]2 3 4:LIMit:FCOUNT?	202
CALCulate[1]2 3 4:LIMit:LOWer[:DATA] <numeric_value>	204
CALCulate[1]2 3 4:LIMit:UPPER[:DATA] <numeric_value>	206
CALCulate[1]2 3 4:LIMit:STATe <boolean>	209
CALCulate[1]2 3 4:MATH Commands	211
CALCulate[1]2 3 4:MATH[:EXPRESSION] <string>	212
CALCulate[1]2 3 4:MATH[:EXPRESSION]:CATalog?	215
CALCulate[1]2 3 4:PHOLD:CLEar	216
CALCulate[1]2 3 4:RELative Commands	217
CALCulate[1]2 3 4:RELative[:MAGNitude]:AUTO <boolean> ONCE	218
CALCulate[1]2 3 4:RELative:STATe <boolean>	220

This chapter explains how the **CALCulate** subsystem is used to perform post acquisition data processing.

## CALCulate Subsystem

The **CALCulate** subsystem performs post acquisition data processing. Functions in the **SENSe** subsystem are related to data acquisition, while the **CALCulate** subsystem operates on the data acquired by a **SENSe** function.

There are four independent **CALCulate** blocks in the power meter: two for each window, as shown in [Figure 3-1](#). The numeric suffix of the **CALCulate** command determines which **CALCulate** block is used and where the measurement result is displayed.

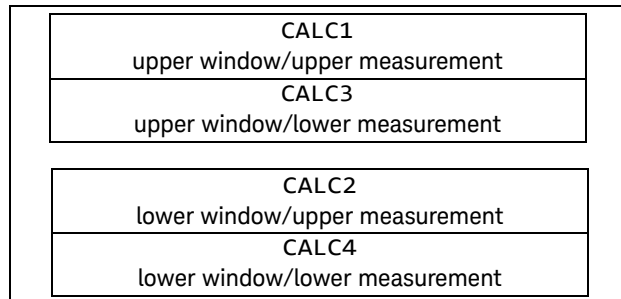

**Figure 3-1** Measurement display CALCulate block window

Data from both **SENSe** blocks may feed any or all of the **CALCulate** blocks via the **MATH** command. [Figure 3-1](#) details where the commands are applied with in the **CALCulate** block.

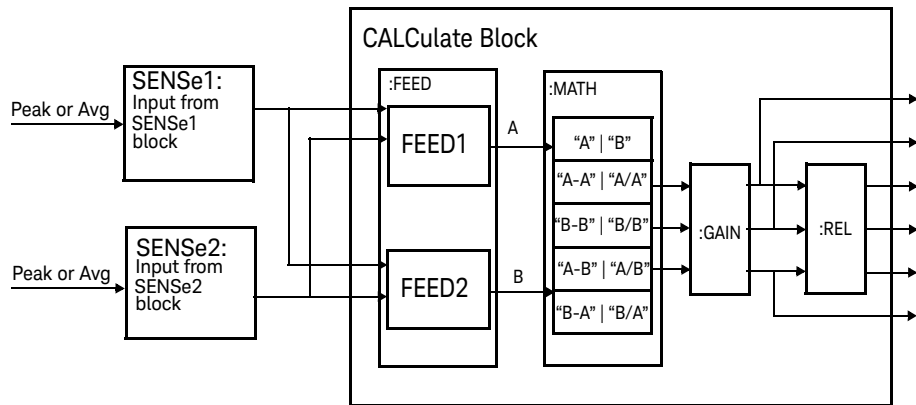

Figure 3-2 CALCulate block

Keyword	Parameter Form	Notes	Page
CALCuLate[1] 2 3 4			
:FEED[1] 2	<data_handle>		page 189
:GAIN			
[:MAGNitude]	<numeric_value>		page 193
:STATe	<boolean>		page 195
:LIMit			
:CLEar			
:AUTO	<boolean> ONCE		page 198
[:IMMediate]			page 200
:FAIL?		[query only]	page 201
:FCOunt?		[query only]	page 202
:LOWer			
[:DATA]	<numeric_value>		page 204
:UPPer			
[:DATA]	<numeric_value>		page 206
:STATe	<boolean>		page 209
:MATH			
[:EXPRession]	<string>		page 212
:CATalog?		[query only]	page 215
:PHOLd			
:CLEar		[no query]	page 216
:RELative			
[:MAGNitude]			
:AUTO	<boolean> ONCE		page 218
:STATe	<boolean>		page 220

## CALCulate[1]|2|3|4:FEED[1]|2 <string>

This command sets the input measurement mode to be fed to the specified input on the **CALC** block. It is applied to the measurement after the **CALC:MATH:EXPR** command has been used to specify which channel the feed is taken from.

Measurement modes are coupled for combination measurements (for example, ratio measurements). For example, if one feed is changed to **PTAV**, the other is automatically changed to **PTAV**.

Under certain circumstances the measurement mode is changed by the **CALC:MATH:EXPR** command. Refer to “**CALCulate[1]|2|3|4:MATH[:EXPRession]** <string>” on page 212 for further information.

### Syntax

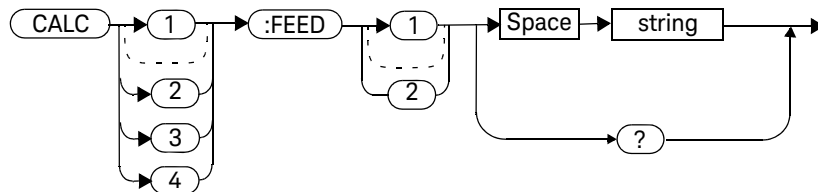

## Parameters

Item	Description	Range of Values
string	<p>The input measurement type to be fed to the specific input on the CALC block:</p> <ul style="list-style-type: none"> <li>– <b>PEAK</b>: peak power</li> <li>– <b>PTAV</b>: peak to average</li> <li>– <b>AVER</b>: average</li> </ul> <p>Values may be followed by <b>ON SWEEP[1] 2 3 4</b> where the numeric specifies the gate to be used for the feed. For example: <b>"POW:PEAK ON SWEEP2"</b>.</p> <p>If <b>ON SWEEP[1] 2 3 4</b> is not supplied, the gate used is left unchanged.</p> <p>A feed of "" (empty string) disables the CALC block and switches off that display line.</p>	<p><b>"POW:PEAK"</b>  <b>"POW:PTAV"</b>  <b>"POW:AVER"</b></p>

## Example

**CALC3:FEED2 "POW:AVER ON SWEEP2"**

*This command selects the input for FEED2 of CALC block CALC3 to be average power, using gate 2. The channel from which the feed is taken is determined by **CALC:MATH:EXPR..***

## Reset Condition

On reset, data\_handle is set to **:POW:AVER**.

## Query

**CALCulate[1]|2|3|4:FEED[1]2?**

The query returns the current value of the string.

## Query Example

**CALC1:FEED2?**

*This command queries the current setting of the data\_handle on FEED2 of the upper window/upper measurement.*

## Error Message

- If the command is used when no sensor is attached, error -241 “Hardware missing” occurs.
- If <string> contains **ON SWEEP[1]|2|3|4** and the feed’s **TRIG:SOUR** is not **INT** or **EXT** (for single channel power meters) or **INT1**, **INT2** or **EXT** (for dual channel power meters), error -221 “Settings conflict” occurs.
- If the command changes the measurement mode to **PEAK** or **PTAV** when a sensor other than a P-Series power sensor is connected or a P-Series sensor is connected and set to **AVERage** mode rather than **NORMa1** mode, error -221, “Settings Conflict” occurs.

## CALCulate[1]|2|3|4:GAIN Commands

These commands are used to enter and enable a display offset on the specified window/measurement. The display offset is applied to the measurement signal after any math calculation.

The following commands are detailed in this section:

```
CALCulate[1]|2|3|4:GAIN[:MAGNitude] <numeric value>
```

```
CALCulate[1]|2|3|4:GAIN:STATE <boolean>
```



## CALCulate[1]|2|3|4:GAIN[:MAGNitude] <numeric\_value>

This command is used to enter a value for the display offset on the specified window/measurement. The display offset is applied to the measurement signal after any math calculation.

Entering a value using this command automatically turns the **CALCulate[1]|2|3|4:GAIN:STATE** command to **ON**.

### Syntax

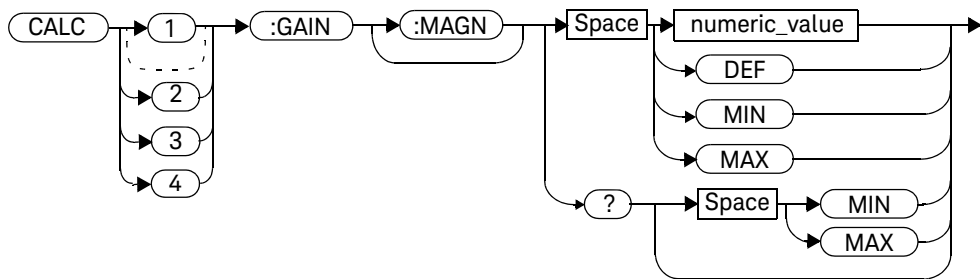

### Parameters

Item	Description/Default	Range of Values
numeric_value	A numeric value for the display offset: – <b>DEF</b> : the default value is 0 dB – <b>MIN</b> : -100.000 dB – <b>MAX</b> : +100.000 dB	-100.000 to +100.000 dB <b>DEF</b> <b>MIN</b> <b>MAX</b>

## Example

**CALC2:GAIN 20**

*This command enters a display offset of 20 dB to the lower window/lower measurement.*

## Reset Condition

On reset, the display offset is set to 0 dB (**DEF**).

## Query

**CALCulate[1]|2|3|4:GAIN[:MAGNitude]? [MIN|MAX]**

The query returns the current setting of the display offset or the value associated with **MIN** and **MAX**.

## Query Example

**CALC1:GAIN?**

*This command queries the current setting of the display offset on the upper window/upper measurement.*

## Error Message

If **CALCulate[1]|2|3|4:GAIN[:MAGNitude]** is set to **ON** while **SENSe:SPEEd** is set to 200, error -221, "Settings Conflict" occurs.

## CALCulate[1]|2|3|4:GAIN:STATe <boolean>

This command is used on the specified window/measurement to enable and disable the display offset set by the **CALCulate[1]|2|3|4:GAIN[:MAGNitude]** command.

### Syntax

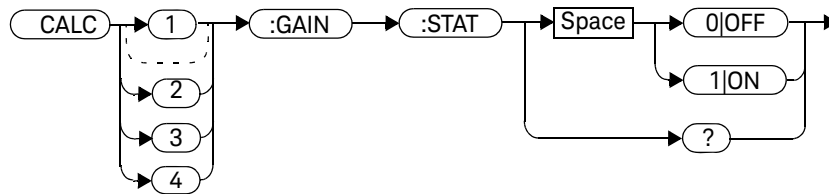

### Example

**CALC2:GAIN:STAT 1**

*This command enables the display offset for the lower window/upper measurement.*

### Reset Condition

On reset, the gain is disabled.

### Query

**CALCulate[1]|2|3|4:GAIN:STATe?**

The query enters a 1 or 0 into the output buffer indicating the status of the display offset.

- 1 is returned when the display offset feature is enabled
- 0 is returned when the display offset feature is disabled

### 3 CALCulate Subsystem

#### Query Example

**CALC1:GAIN:STAT?**

*This command queries whether the display offset in the upper window/upper measurement is on or off.*

#### Error Message

If **CALCulate[1]|2|3|4:GAIN:STATe** is set to **ON** while **SENSe:SPEEd** is set to 200, error -221, "Settings Conflict" occurs.

## CALCulate[1]|2|3|4:LIMit Commands

These commands set the limits on both the upper and lower windows/measurements enabling you to:

- Set upper and lower level limits
- Query if there has been a failure
- Count the number of failures
- Clear the counter

The following commands are detailed in this section:

**CALCulate[1]|2|3|4:LIMit:CLEar:AUTO <boolean>**

**CALCulate[1]|2|3|4:LIMit:CLEar[IMMediate]**

**CALCulate[1]|2|3|4:LIMit:FAIL?**

**CALCulate[1]|2|3|4:LIMit:FCOunt?**

**CALCulate[1]|2|3|4:LIMit:LOWer[:DATA]**

**CALCulate[1]|2|3|4:LIMit:UPPer[:DATA]**

**CALCulate[1]|2|3|4:LIMit:STATe <boolean>**

## CALCulate[1]|2|3|4:LIMit:CLEar:AUTo &lt;boolean&gt;|ONCE

This command controls when the FCO (fail counter) is cleared of any limit failures. The FCO is used to determine the results returned by the **CALCulate[1]|2|3|4:LIMit:FAIL?** query.

- If **ON** is specified, the FCO is set to 0 each time a measurement is:
  - Initiated using **INITiate[:IMMediate]**
  - Initiated using **INITiate:CONTinuous ON**
  - Measured using **MEASure?**
  - Read using **READ?**
- If **OFF** is specified, the FCO is not cleared by the above commands.
- If **ONCE** is specified, the FCO is cleared only after the first initialization then starts accumulating any limit failures.

## Syntax

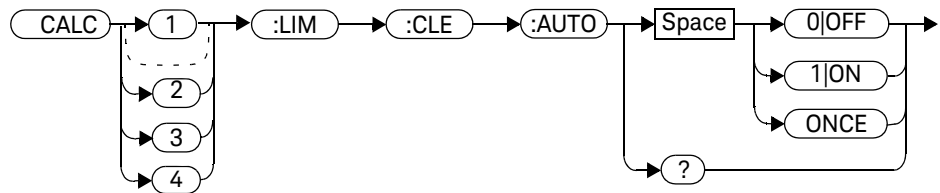

## Example

**CALC1:LIM:CLE:AUTO 1**

*This command switches on automatic clearing of the FCO for the upper window/upper measurement.*

## Reset Condition

On reset, both windows and their measurements are set to **ON**.

## Query

**CALCulate[1]|2|3|4:LIMit:CLEar:AUTO?**

The query command enters a 1 or 0 into the output buffer indicating whether limit failures are cleared automatically when a new measurement is initiated on the specified window section.

- 1 is entered into the output buffer when limit failures are cleared automatically when a new measurement is initiated.
- 0 is entered into the output buffer when limit failures are not cleared automatically when a new measurement is initiated.

In the case where limit failures are cleared once, when a query occurs a 1 is entered into the output buffer if no measurement is initiated. If a measurement is initiated then 0 is entered.

## Query Example

**CALC1:LIM:CLE:AUTO?**

*This command queries when the FCO is cleared for the upper window/upper measurement.*

## CALCulate[1]|2|3|4:LIMit:CLEar[:IMMEDIATE]

This command immediately clears the FCO (fail counter) of any limit failures for the specified window. The FCO is used to determine the results returned by the **CALCulate[1]|2|3|4:LIMit:FAIL?** query.

### Syntax

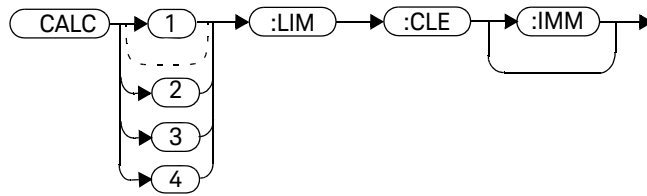

### Example

**CALC2:LIM:CLE:IMM**

*This command clears the FCO for the lower window/upper measurement.*



## CALCulate[1]|2|3|4:LIMit:FAIL?

This query enters a 1 or 0 into the output buffer indicating whether there have been any limit failures for the specified window. A limit failure is defined as **CALC[1]|2|3|4:LIMit:FCO?** being non-zero. The FCO (fail counter) can be zeroed using the **CALC[1]|2|3|4:LIMit:CLEar** command.

- 1 is returned when one or more limit failures have occurred
- 0 is returned when no limit failures have occurred

### Syntax

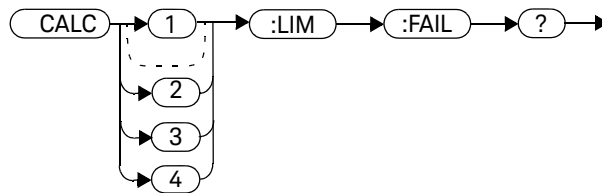

### Example

**CALC1:LIM:FAIL?**

*This command queries if there have been any limit failures on the upper window/upper measurement.*

### Reset Condition

On reset, the buffer is set to zero for both upper and lower window measurements.

## CALCulate[1]|2|3|4:LIMit:FCOunt?

This query returns the total number of limit failures for the specified window/measurement.

If the appropriate **STATe** commands are set to **ON**, each time a measurement is initiated on the specified window/measurement and the result is outside the limits, the counter is incremented by one.

If the measured value is equal to a limit, this is a limit pass.

The counter is reset to zero by any of the following commands:

- **\*RST**
- **CALCulate[1]|2|3|4:LIMit:CLEar:IMMediate**
- **CALCulate[1]|2|3|4:LIMit:CLEar:AUTO ON**

When **CALCulate[1]|2|3|4:LIMit:CLEar:AUTO** is set to **ON**, the counter is set to zero *each* time a measurement is:

- measured using **MEASure?**
- read using **READ?**
- initiated using:
  - **INITiate[:IMMediate]** or,
  - **INITiate:CONTinuous ON**

When **CALCulate[1]|2|3|4:LIMit:CLEar:AUTO** is set to **ONCE**, the counter is set to zero the *first* time a measurement is:

- measured using **MEASure?**
- read using **READ?**
- initiated using:
  - **INITiate[:IMMediate]** or,
  - **INITiate:CONTinuous ON**

The maximum number of errors is  $2^{16}-1$ . If more than  $2^{16}-1$  errors are detected the counter returns to zero.

## Syntax

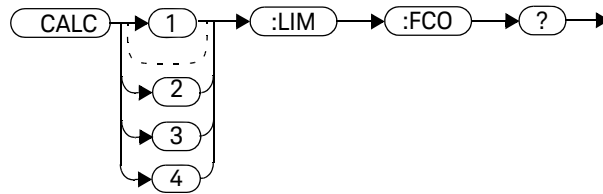

## Example

**CALC1:LIM:FCO?**

*This command queries the number of limit failures on the upper window/upper measurement.*

## Reset Condition

On reset, the counter is set to zero for both measurements of the upper and lower windows.

## CALCulate[1]|2|3|4:LIMit:LOWer[:DATA] <numeric\_value>

This command enters a value for the lower test limit for the specified window/ measurement used in the **CALCulate[1]|2|3|4:LIMit:FAIL?** test. The units used are dependent on the current setting of **UNIT:Power** and **CALCulate:RELative:STATe** as shown in [Table 3-1](#). When the measured value is less than the value specified in **CALCulate[1]|2|3|4:LIMit:LOWer[:DATA]**, **CALCulate[1]|2|3|4:LIMit:FAIL?** reports a fail. When the measured value is greater than or equal to the limit, a fail is not reported.

**Table 3-1** Measurement units

Measurement Mode	Measurement Type	CALC:REL:STAT OFF		CALC:REL:STAT ON	
		Linear	Log	Linear	Log
<b>Single Channel</b>	Avg, Pk	Watt	dBm	%	dB
	Pk-Avg	%	dB	%	dB
<b>Ratio</b>	Avg, Pk, Pk-Avg	%	dB	%	dB
<b>Difference</b>	Avg, Pk	Watt	dBm	%	dB
	Pk-Avg	%	dB	%	dB

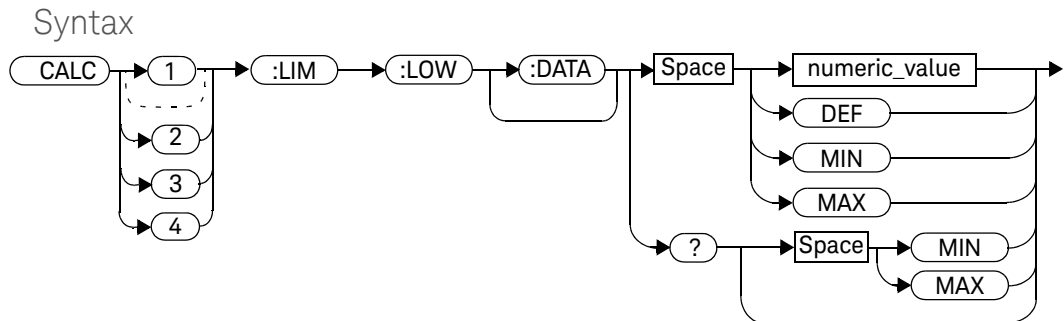

## Parameters

Item	Description/Default	Range of Values
numeric_value	A numeric value for the lower test limit: - <b>DEF</b> : the default is -90.00 dBm or -90 dB - <b>MIN</b> : -150 dBm or -180 dB - <b>MAX</b> : +230 dBm or +200 dB	-150 to +230 dBm or -180 to +200 dB <b>DEF</b> <b>MIN</b> <b>MAX</b>

## Example

**CALC2:LIM:LOW:DATA 0.1**

*This command enters a lower limit for the lower window/upper measurement depending on the window's units as follows:*  
*dBm = 0.1 dBm*  
*W = 100 mW*  
*dB = 0.1 dB*  
*% = 0.1 %*

## Reset Condition

On reset, both measurements of the upper and lower windows are set to -90.00 dBm or -90 dB (**DEF**).

## Query

**CALCulate[1]|2|3|4:LIMit:LOWer[:DATA]? [MIN|MAX]**

The query returns the current setting of the lower limit or the values associated with **MIN** and **MAX** for the specified window.

## Query Example

**CALC2:LIM:LOW:DATA?**

*This command queries the lower limit set for the lower window upper measurement.*

## CALCulate[1]|2|3|4:LIMit:UPPer[:DATA] <numeric\_value>

This command enters a value for the upper test limit for the specified window/measurement used in the **CALCulate[1]|2|3|4:LIMit:FAIL?** test. The units used are dependent on the current setting of **UNIT:POWER** and **CALCulate:RELative:STATE** as shown in [Table 3-2](#). When the measured power is greater than the value specified in **CALCulate[1]|2|3|4:LIMit:UPPer[:DATA]**, **CALCulate[1]|2|3|4:LIMit:FAIL?** reports a fail. When the measured level is less than or equal to the limit, a fail is not reported.

**Table 3-2** Measurement units

Measurement Mode	Measurement Type	CALC:REL:STAT OFF		CALC:REL:STAT ON	
		Linear	Log	Linear	Log
<b>Single Channel</b>	Avg, Pk	Watt	dBm	%	dB
	Pk-Avg	%	dB	%	dB
<b>Ratio</b>	Avg, Pk, Pk-Avg	%	dB	%	dB
<b>Difference</b>	Avg, Pk	Watt	dBm	%	dB
	Pk-Avg	%	dB	%	dB

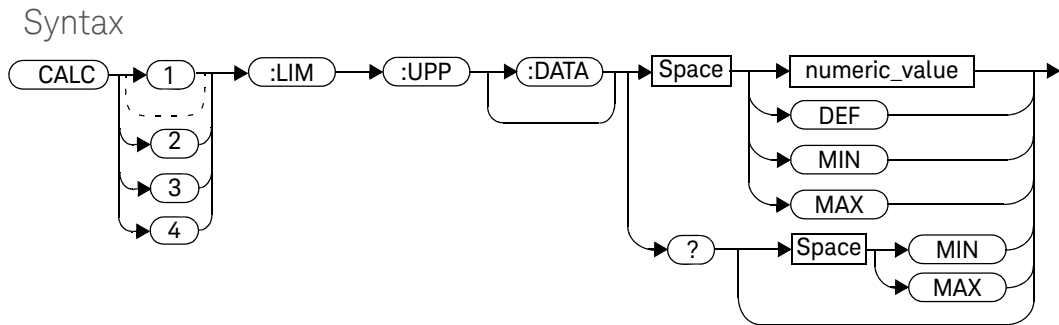

## Parameters

Item	Description/Default	Range of Values
numeric_value	A numeric value for the lower test limit: - <b>DEF</b> : the default is -90.00 dBm or -90 dB - <b>MIN</b> : -150 dBm or -180 dB - <b>MAX</b> : +230 dBm or +200 dB	-150 to +230 dBm or -180 to +200 dB <b>DEF</b> <b>MIN</b> <b>MAX</b>

## Example

**CALC2:LIM:UPP:DATA 5**

*This command enters an upper limit for the lower window/upper measurement depending on the window's units as follows:*  
 dBm = 5 dBm  
 W = 5 W  
 dB = 5 dB  
 % = 5 %

## Reset Condition

On reset, both channels are set to +90.00 dBm or +90 dB.

## Query

**CALCulate[1]|2|3|4:LIMit:UPPer[:DATA]? [MIN|MAX]**

## Query Example

**CALC2:LIM:UPP:DATA?**

*This command queries the setting of the upper limit for the lower window/upper measurement.*

The query returns the current setting of the upper limit or the values associated with **MIN** and **MAX** for the specified window/measurement.



## CALCulate[1]|2|3|4:LIMit:STATe <boolean>

This command enables/disables the test limits for the specified window.

### Syntax

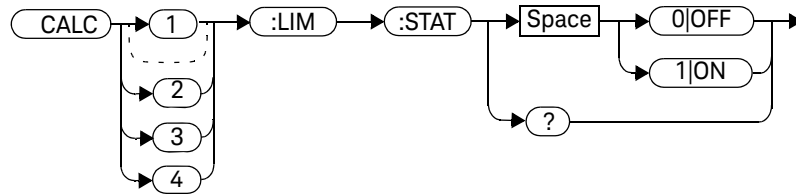

### Example

**CALC2:LIM:STAT 1**

*This command enables the limit checking function for the lower window upper measurement.*

### Reset Condition

On reset, limit checking is disabled.

### Query

**CALCulate[1]|2|3|4:LIMit:STATe?**

The query enters 1 or 0 into the output buffer indicating the status of the limits testing feature for the specified window/measurement.

- 1 is returned when limits testing is enabled
- 0 is returned when limits testing is disabled

### 3 CALCulate Subsystem

#### Query Example

**CALC1:LIM:STAT?**

*This command queries whether the limit checking function for the upper window/upper measurement is on or off.*

#### Error Message

If **CALCulate[1|2|3|4]:LIMit:STATe** is set to **ON** while **[SENSe[1]]|SENSe2:SPEed** is set to 200, error -221, “Settings Conflict” occurs.

## CALCulate[1]|2|3|4:MATH Commands

These commands define and carry out the following mathematical transformations on **SENSE** data:

- Single channel
- Difference
- Ratio

The following commands are detailed in this section:

**CALCu**late[1]|2|3|4:**MATH**[:**EXPR**ession] <string>

**CALCu**late[1]|2|3|4:**MATH**[:**EXPR**ession]:**CATa**log?

## CALCulate[1]|2|3|4:MATH[:EXPRession] <string>

This command sets the specified window/measurement to a single channel, difference or ratio measurement.

The command may result in a change to the measurement mode set by **CALC:FEED <string>**. The following sequence of commands provides an example:

- 1 SENS2:DET:FUN=AVERage
- 2 CALC:MATH “(SENS1)”
- 3 CALC:FEED1 “POW:PEAK”
- 4 CALC:MATH “(SENS2)”

The **FEED1** measurement mode, set in step 3, is made invalid by step 4 and automatically changed to “**POW: AVER**”.

### Syntax

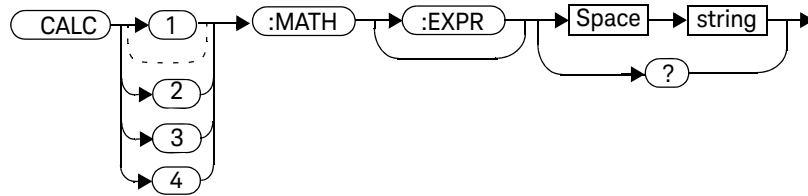

## Parameters

Item	Description/Default	Range of Values
string	A single string value detailing the measurement type: – The default is <b>SENS1</b> if the upper window is selected, or <b>SENS2</b> if the lower window is selected.	“(SENS1)” <sup>[a]</sup> “(SENS2)” <sup>[a]</sup> “(SENS1-SENS1)” <sup>[a]</sup> “(SENS2-SENS2)” <sup>[a]</sup> “(SENS1/SENS1)” <sup>[a]</sup> “(SENS2/SENS2)” <sup>[a]</sup> “(SENS1-SENS2)” <sup>[a]</sup> “(SENS2-SENS1)” <sup>[a]</sup> “(SENS1/SENS2)” <sup>[a]</sup> “(SENS2/SENS1)” <sup>[a]</sup>

[a] Quotes are mandatory. Either single or double quotes may be used.

## Example

**CALC2:MATH “(SENS2/SENS1)”** *This command sets the lower window/upper measurement to make a Channel B/A ratio measurement.*

## Reset Condition

On reset, the upper window measurements are set to Channel A (“(SENS1)”) and the lower window measurements to Channel B (“(SENS2)”).

### 3 CALCulate Subsystem

#### Query

**CALCulate[1]|2|3|4:MATH[:EXPRession]?**

The query returns the current math measurement setting on the specified window.

#### Query Example

**CALC1:MATH?**

*This command queries the current setting of the math expression on the upper window/upper measurement.*

#### Error Messages

- If <string> is not set to "(SENS1)" or "(SENS2)" while **SENS1:SPEED** or **SENS2:SPEED** is set to 200, error -221, "Settings Conflict" occurs.

## CALCulate[1]|2|3|4:MATH[:EXPRession]:CATalog?

This query lists all the defined expressions. The response is a list of comma separated strings. Each string contains an expression.

- The string is:  
 "(SENS1)", "(SENS2)", "(SENS1/SENS2)",  
 "(SENS2/SENS1)", "(SENS1-SENS2)", "(SENS2-SENS1)",  
 "(SENS1-SENS1)", "(SENS2-SENS2)", "(SENS1/SENS1)",  
 "(SENS2/SENS2)"

### Syntax

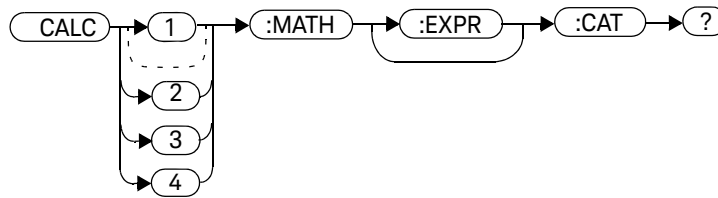

### Example

**CALC1:MATH:CAT?**

*This command lists all the defined math expressions.*

## CALCulate[1]|2|3|4:PHOLd:CLEAr

This command clears the peak hold value for a specified CALC block so that a new peak hold value can be set.

**NOTE**

Clearing the peak hold value for a specified CALC block may affect the peak hold value of other CALC blocks, depending on the CALC channel set up (set by `CALC:MATH:EXPR`).

## Syntax

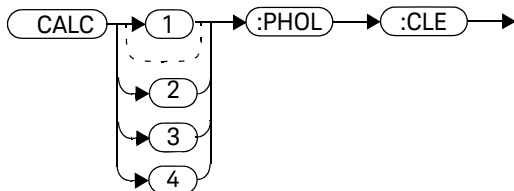

## Example

`CALC2:PHOLd:CLEAr`

*This command clears the peak hold value for CALC2.*

## Error Messages

- If no power sensor is connected, error -241 “Hardware missing” occurs.
- If a sensor, other than an P-Series power sensor, is connected, error -241 “Hardware missing” occurs.
- If `SENS:DET:FUNC` is set to `AVER` or `TRIG:SOUR` is set to `INT1`, `INT2` or `EXT`, error -221 “Settings conflict” occurs.



## CALCulate[1]|2|3|4:RELative Commands

These commands compare the measurement signal to a reference value.

Within the **CALCulate** block the relative value is applied to the measurement signal after any math calculations and display offsets have been applied.

The commands described in this section:

```
CALCulate[1]|2|3|4:RELative[:MAGNitude]:AUTO <boolean>|ONCE
```

```
CALCulate[1]|2|3|4:RELative:STATE <boolean>
```

## CALCulate[1]|2|3|4:RELative[:MAGNitude]:AUTO <boolean>|ONCE

This command sets the reference value to be used in the relative measurement. Within the **CALCulate** block the relative value is applied to the measurement signal after any math calculations and display offsets have been applied.

The value should be set to **ONCE** to set the reference value to be used in relative measurements. Selecting **ONCE** sets the reference value to that of the measurement signal after any math calculations and display offsets have been applied. After the reference value has been set the command returns to **OFF**. Setting this command to **ONCE** turns the **CALCulate[1]|2|3|4:RELative:STATE** command to **ON**.

If **0|OFF** is selected, no reference value is applied to the measurement signal. There is no situation in which you would want to send this command with **OFF**. **OFF** is only available because it is required for the query response.

If **1|ON** is selected, it causes error -224, "Illegal parameter value" to occur.

### Syntax

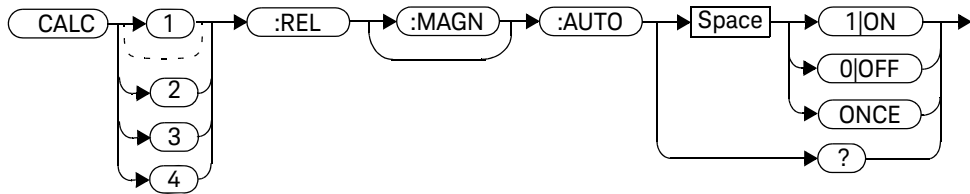

## Example

**CALC1:REL:AUTO ONCE**

*This command sets a reference value to be used in the relative measurement on the upper window/upper measurement.*

## Query

**CALCulate[1]|2|3|4:RELative[:MAGNitude]:AUTO?**

The query always returns **OFF**.

## Error Message

- If **CALCulate:RELative[:MAGNitude]:AUTO** is set to **ONCE** while **SENSE:SPEEd** is set to 200, error -221, "Settings Conflict" occurs.
- If the value is set to **ON** error -224, "Illegal parameter value" occurs.

## CALCulate[1]|2|3|4:RELative:STATe <boolean>

This command enables/disables relative mode. If the command is:

- disabled, the measurement signal remains unchanged.
- enabled, the current relative value set by **CALCulate:RELative:MAGnitude:AUTO** is applied to the measurement signal.

### Syntax

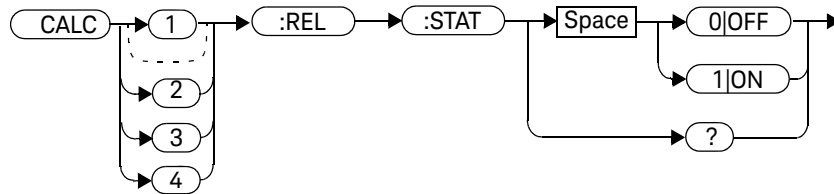

### Example

**CALC1:REL:STAT OFF**

*This command disables the relative mode on the upper window/upper measurement.*

### Reset Condition

On reset, relative mode is disabled.

### Query

**CALCulate[1]|2|3|4:RELative:STATe?**

The query returns a 1 or 0 into the output buffer.

- 1 is returned when relative mode is enabled
- 0 is returned when relative mode is disabled

## Query Example

**CALC1:REL:STAT?**

*This command queries whether relative mode is off or on for the upper window/upper measurement.*

## Error Message

If **CALCulate:RELative:STATe** is set to **ON** while **SENSe:SPEed** is set to 200, error -221, "Settings Conflict" occurs.

THIS PAGE HAS BEEN INTENTIONALLY LEFT BLANK.

## 4 CALibration Subsystem

CALibration Subsystem	224
CALibration[1]2[:ALL]	226
CALibration[1]2[:ALL]?	228
CALibration[1]2:AUTO [ONCE ON OFF 0 1]	230
CALibration[1]2:RCALibration <boolean>	232
CALibration[1]2:RCFactor <numeric_value>	234
CALibration[1]2:ZERO:AUTO [ONCE ON OFF 0 1]	237
CALibration[1]2:ZERO:NORMAl:AUTO <boolean>	239

This chapter explains how the **CALibration** command subsystem is used to zero and calibrate the power meter.

## CALibration Subsystem

The **CALibration** command subsystem is used to zero and calibrate the power meter. It is also used to set the reference calibration factor for the power sensor which is being used.

The numeric suffix of the **CALibration** command refers to a specific channel:

- **CALibration1** represents Channel A
- **CALibration2** represent Channel B

Zeroing and calibration of the power meter is recommended:

- When a 5 °C change in temperature occurs
- When you change the power sensor
- Every 24 hours
- Prior to measuring low level signals. For example, 10 dB above the lowest specified power for your sensor.

The following **CALibration** commands are overlapped commands:

- **CAL:ALL**
- **CAL:AUTO**
- **CAL:ZERO:AUTO**

An overlapped command allows the instrument to continue parsing and executing subsequent commands while it is still executing.



Keyword	Parameter Form	Notes	Page
<b>CALibration[1] 2</b>			
[:ALL]		[event; no query]	page 226
[:ALL]?		[event;query]	page 228
:AUTO	<boolean> ONCE		page 230
:RCALibration	<boolean>		page 232
:RCFactor	<numeric_value>	[non-SCPI]	page 234
:ZERO			
:AUTO	<boolean> ONCE		page 237
:NORMal			
:AUTO	<boolean>		page 239

## CALibration[1]|2[:ALL]

**NOTE**

This command is identical to `CALibration[1]|2[:ALL]?`, however, unlike the query it does not provide a response to indicate whether the calibration has been successful or not.

---

This command causes the power meter to perform a calibration sequence on the specified channel. The command assumes that the power sensor is connected to the POWER REF output. The calibration sequence consists of:

- 1 Zeroing the power meter (**CALibration:ZERO:AUTO ONCE**), and
- 2 Calibrating the power meter (**CALibration:AUTO ONCE**).

For 8480 Series power sensors the reference calibration factor used during this calibration can be derived from either an active sensor calibration table or the value entered using **CALibration:RCFactor**. The actual value used is the one which was most recently set. That is, a value entered using **CALibration:RCFactor** is overridden if a sensor calibration table is subsequently selected and enabled. Conversely, **CALibration:RCFactor** overrides any reference calibration factor previously set from a sensor calibration table. To determine the currently set reference calibration factor use **CALibration:RCFactor?**.

E-Series power sensors have their sensor calibration tables stored in EEPROM which means that the reference calibration factor is automatically downloaded by the power meter.

## Syntax

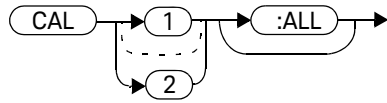

## Example

**CAL1:ALL**

*This command causes the power meter to perform a calibration sequence on Channel A.*

## Error Messages

- If the calibration was not carried out successfully the error -231, “Data Questionable; CAL ERROR” occurs. The error message will specify which channel failed calibration.
- If zeroing was not carried out successfully the error -231, “Data Questionable; ZERO ERROR” occurs. The error message will specify which channel failed calibration.
- If there is no sensor connected, the error -241, “Hardware Missing” occurs.

## CALibration[1]|2[:ALL]?

**NOTE**

This query is identical to **CALibration[1]|2[:ALL]**, however, unlike the command, it provides a response to indicate whether the calibration has been successful or not.

This query causes the power meter to perform a calibration sequence on the specified channel. The query assumes that the power sensor is connected to the POWER REF output. The calibration sequence consists of:

- 1 Zeroing the power meter (**CALibration:ZERO:AUTO ONCE**), and
- 2 Calibrating the power meter (**CALibration:AUTO ONCE**).

When the calibration sequence is completed, 0 or 1 is entered into the output buffer to indicate if the sequence was successful. If the result is:

- 0, the calibration has passed
- 1, the calibration has failed

For the 8480 power sensors the reference calibration factor used during this calibration can be derived from either an active sensor calibration table or the value entered using **CALibration:RCFactor**. The actual value used is the one which was most recently set. That is, a value entered using **CALibration:RCFactor** is overridden if a sensor calibration table is subsequently selected and enabled. Conversely, **CALibration:RCFactor** overrides any reference calibration factor previously set from a sensor calibration table. To determine the currently set reference calibration factor use **CALibration:RCFactor?**.

The E-Series power sensors have their sensor calibration tables stored in EEPROM which means that the reference calibration factor is automatically downloaded by the power meter.

## Syntax

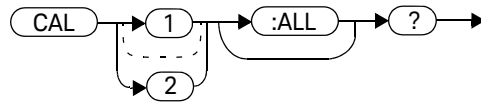

## Query Example

**CAL1:ALL?**

*This command causes the power meter to perform a calibration sequence on Channel A and return a result.*

## Error Messages

- If the calibration was not carried out successfully the error -231, “Data Questionable; CAL ERROR” occurs. The error message will specify which channel failed calibration.
- If zeroing was not carried out successfully the error -231, “Data Questionable; ZERO ERROR” occurs. The error message will specify which channel failed calibration.
- If there is no sensor connected, the error -241, “Hardware Missing” occurs.

## CALibration[1]|2:AUTO [ONCE|ON|OFF|0|1]

This command calibrates the specified channel when enabled. The command assumes that an 8480 or E-Series power sensor is connected to a 1 mW reference signal.

**1|ON** can only be used with a P-Series sensor. When **1|ON** is enabled the calibration is updated if the meter's or sensor's temperature changes by  $\pm 5$  °C or the time since last calibration is greater than 1000 minutes.

The **0|OFF** parameter is only required for the query response and is ignored in the command.

The E-Series power sensors have their sensor calibration tables stored in EEPROM which means that the reference calibration factor is automatically downloaded by the power meter.

For 8480 Series power sensors the reference calibration factor used during this calibration can be obtained from an active sensor calibration table or the value entered using **CALibration:RCFactor**. The actual value used is the one which was most recently set. For example, a value entered using **CALibration:RCFactor** is overridden if a sensor calibration table is subsequently selected and enabled and **CALibration:RCFactor** overrides any reference calibration factor previously set from a sensor calibration table. To determine the current reference calibration factor, use **CALibration:RCFactor?**.

**NOTE**

If the power meter is using an 8480 or E-Series power sensor it should be zeroed before calibration using the **CALibration:ZERO:AUTO ONCE** command.

## Syntax

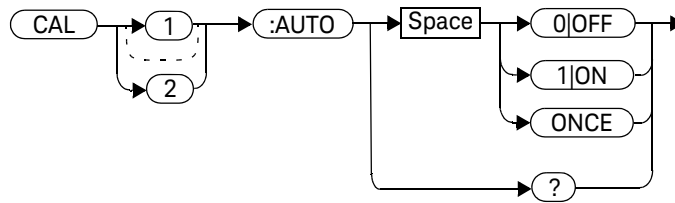

## Example

**CAL1:AUTO ONCE**

*This command causes the power meter to perform a calibration on Channel A.*

## Reset Condition

On reset, automatic calibration is disabled.

## Query

**CALibration[1]|2:AUTO?**

The query always returns a value of 0.

## Error Messages

- If this command is set to **ON** and an 8480 Series or E-Series power sensor is connected the error -241, “Hardware missing” occurs.
- If the calibration was not carried out successfully the error -231, “Data Questionable; CAL ERROR” occurs. The error message will specify which channel failed calibration.
- If there is no sensor connected, the error -241, “Hardware Missing” occurs.

## CALibration[1]|2:RCALibration &lt;boolean&gt;

This command enables and disables the zero/cal lockout facility. With the lockout facility enabled the power meter is stopped from making measurements until the connected sensor has been zeroed and calibrated.

## Syntax

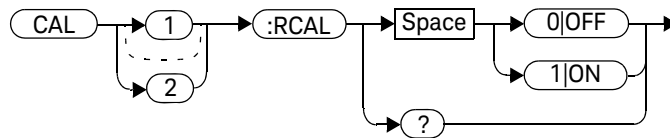

## Example

**CAL1:RCAL 1**

*This command enables the zero/cal lockout facility on Channel A.*

## Reset Condition

On reset, the state of the zero/cal lockout is unaffected.

## Query

**CALibration[1]|2:RCALibration?**

The query enters a 1 or 0 into the output buffer indicating whether zero/cal lockout is enabled or disabled.

- 1 is returned if zero/cal lockout is enabled
- 0 is returned if zero/cal lockout is disabled



## Query Example

**CAL1:RCAL?**

*This command queries whether or not the zero/cal lockout facility is enabled for Channel A.*

## Error Messages

When **CAL[1]|2:RCAL** is **ON** and the sensor currently connected to the appropriate channel (A or B) has not been zeroed and calibrated, then any SCPI command which would normally return a measurement result (for example, **FETC?**, **READ?**, **MEAS?** etc) does not return a result and generates the error -230, "Data corrupt or stale; Please zero and Cal."

After the sensor has been zeroed and calibrated the return measurement results commands function normally.

## CALibration[1]|2:RCFactor <numeric\_value>

This command is used with 8480 Series power sensors to set the reference calibration factor of the specified channel. Reference calibration factors can also be set using sensor calibration tables. The power meter uses the most recently set reference calibration factor.

### Syntax

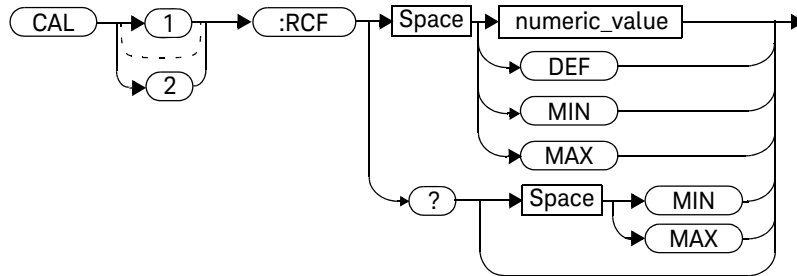

### Parameters

Item	Description/Default	Range of Values
numeric_value	A numeric value: - DEF: the default is 100 % - MIN: 1 % - MAX:150 %	1.0 to 150.0 PCT DEF MIN MAX

### Example

**CAL1:RCF 98**

*This command enters a reference calibration factor of 98 % to Channel A.*

### Reset Condition

On reset, the reference calibration factor is set to 100 %.

## Query

**CALibration[1]|2:RCFactor? [MIN|MAX]**

The query returns the current setting of the reference calibration factor or the values associated with **MIN** and **MAX**.

## Query Example

**CAL2:RCF?**

*This command queries the reference calibration factor of Channel B.*

## Error Messages

If this command is used when a P-Series or E-Series power sensor is connected the error -241, "Hardware missing" occurs.

## CALibration[1]|2:ZERO:AUTO [ONCE|ON|OFF|0|1]

This command causes the power meter to perform its zeroing routine on the specified channel when enabled. This adjusts the power meter for a zero power reading with no power supplied to the power sensor.

**1|ON** can only be used with a P-Series sensor. When **1|ON** is enabled the zero is maintained by a combination of *on-the-fly* zero measurements and temperature compensation.

The **0|OFF** parameter is only required for the query response and is ignored in the command.

Except when using a P-Series sensor, this command assumes that a power sensor is not connected to a power source.

### Syntax

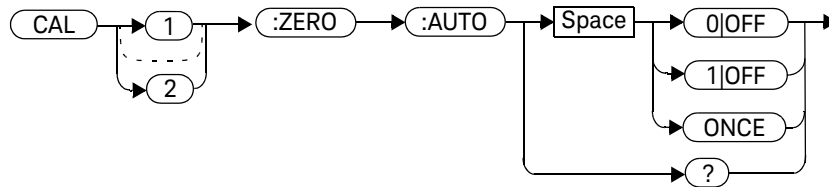

### Example

**CAL2:ZERO:AUTO ONCE**

*This command causes the power meter to perform a zeroing routine on Channel B.*

### Reset Condition

On reset, automatic zeroing is disabled.

## Query

**CALibration[1]|2:ZERO:AUTO?**

The query always returns a value of 0.

## Error Messages

- If this command is set to **ON** and an 8480 Series or E-Series power sensor is connected the error -241, “Hardware missing” occurs.
- If zeroing was not carried out successfully the error -231, “Data Questionable; ZERO ERROR” occurs. The error message will specify which channel failed zeroing.
- If there is no sensor connected, the error -241, “Hardware Missing” occurs.

## CALibration[1]|2:ZERO:NORMal:AUTO &lt;boolean&gt;

This command can only be used to zero a P-Series sensor.

**NOTE**

The P-Series sensor only has a NORMAL path.

The command causes the power meter to perform its zeroing routine, on the specified channel, when **ONCE** is selected. This adjusts the power meter for a zero power reading with no power supplied to the power sensor.

The **0|OFF** parameter is only required for the query response and is ignored in the command.

## Syntax

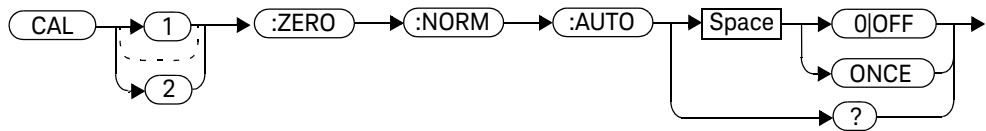

## Example

**CAL2:ZERO:NORM:AUTO ONCE**

*This command causes the power meter to perform a zeroing routine on Channel B.*

## Reset Condition

On reset, automatic zeroing is disabled.

## Query

**CALibration[1]|2:ZERO:NORMal:AUTO?**

The query always returns a value of 0.

## Error Messages

- If zeroing was not carried out successfully the error -231, “Data Questionable; ZERO ERROR” occurs. The error message will specify which channel failed zeroing.
- If this command is set to **ON** the error -224, “Illegal parameter value” occurs.
- If there is no sensor connected, or if a sensor other than P-Series is connected, the error -241, “Hardware missing” occurs.



# 5 DISPLAY Subsystem

DISPlay Subsystem	242
DISPlay:ENABle <boolean>	243
DISPlay:SCReen:FORMat <character_data>	245
DISPlay[:WINDow[1]2] Commands	247
DISPlay[:WINDow[1]2]:ANALog Commands	248
DISPlay[:WINDow[1]2]:ANALog:LOWer <numeric_value>	249
DISPlay[:WINDow[1]2]:ANALog:UPPer <numeric_value>	252
DISPlay[:WINDow[1]2]:FORMat <character_data>	255
DISPlay[:WINDow[1]2]:METer Commands	258
DISPlay[:WINDow[1]2]:METer:LOWer <numeric_value>	259
DISPlay[:WINDow[1]2]:METer:UPPer <numeric_value>	262
DISPlay[:WINDow[1]2][:NUMer[1]2]:RESolution <numeric_value>	265
DISPlay[:WINDow[1]2]:SELect[1]2	267
DISPlay[:WINDow[1]2][:STATe] <boolean>	269
DISPlay[:WINDow[1]2]:TRACe:FEED <character_data>	271

This chapter explains how the **DISPlay** subsystem is used to control the selection and presentation of the windows used on the power meter's display.

## Display Subsystem

The **DISPlay** subsystem is used to control the selection and presentation of the windows used on the power meter's soft front panel display.

Keyword	Parameter Form	Notes	Page
<b>DISPlay</b>			
:ENABle	<boolean>		page 243
:SCReen			
:FORMat	<character_data>		page 245
[:WINDow[1] 2]			
:ANALog			
:LOWer	<numeric_value>		page 249
:UPPer	<numeric_value>		page 252
:FORMat	<character_data>	[non-SCPI]	page 255
:METer			
:LOWer	<numeric_value>	[non-SCPI]	page 259
:UPPer	<numeric_value>	[non-SCPI]	page 262
[:NUMeric[1] 2]			
:RESolution	<numeric_value>		page 265
:SElect[1] 2			page 267
:STATe]	<boolean>		page 269
:TRACe			
:FEED	<character_data>		page 271

## DISPlay:ENABLE <boolean>

This command is used to enable and disable the display. At power-up the display is always enabled.

### Syntax

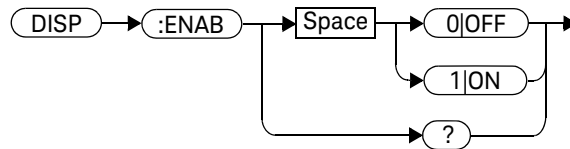

### Example

**DISP:ENAB 0**

*This command disables the display.*

### Reset Condition

On reset, the display is enabled.

### Query

**DISPlay:ENABle?**

The query returns a 1 or 0 into the output buffer.

- 1 is returned when the display is enabled
- 0 is returned when the display is disabled

## Query Example

`DISP:ENAB?`

*This command queries whether the display is on or off.*

## DISPlay:SCReen:FORMat &lt;character\_data&gt;

This command sets the display format.

## Syntax

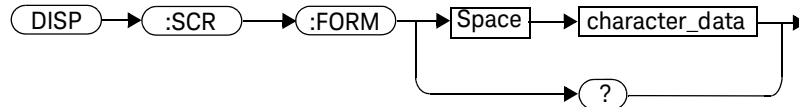

## Parameters

Item	Description/Default	Range of Values
character_data	Sets the display format: <ul style="list-style-type: none"> <li>- <b>WIND</b>owed: the windowed format provides two display windows. Each window can display two measurements.</li> <li>- <b>EXP</b>anded: the expanded format provides one display window which can display a single measurement. The EXP display format provides access to softkeys.</li> <li>- <b>FSCR</b>een: the full screen format provides one display window which can display a single measurement. The FSCR display format does not provide access to softkeys.</li> </ul>	<b>WIND</b> <b>EXP</b> <b>FSCR</b>

## Example

**DISP:SCReen:FORM FSCR**

*This command sets the display format to full screen.*

## Reset Condition

On reset, the display format is **WIND**.

## Query

**DISPlay:SCReen:FORMat?**

The query returns **WIND**, **EXP** or **FSCR**. .

## Query Example

**DISP:SCR:FORM?**

*This command queries the display format.*

## DISPlay[:WINDow[1]|2] Commands

These commands control various characteristics of the display windows. **WINDow1** and **WINDow2** represent the upper and lower windows respectively.

The following commands are detailed in this section:

DISPlay[:WINDow[1]|2]:ANALog:LOWer <numeric\_value>

DISPlay[:WINDow[1]|2]:ANALog:UPPer <numeric\_value>

DISPlay[:WINDow[1]|2]:FORMat <character\_data>

DISPlay[:WINDow[1]|2]:METer:LOWer <numeric\_value>

DISPlay[:WINDow[1]|2]:METer:UPPer <numeric\_value>

DISPlay[:WINDow[1]|2][NUMeric[1|2]]:RESolution <numeric\_value>

DISPlay[:WINDow[1]|2]:SELEct[1]|2

DISPlay[:WINDow[1]|2][:STATe] <boolean>

DISPlay[:WINDow[1]|2]:TRACe:FEED <character\_data>

## DISPlay[:WINDow[1]|2]:ANALog Commands

These commands control the upper and lower scale limits of the analog meter.

The following commands are detailed in this section:

```
DISPlay[:WINDow[1]|2]:ANALog:LOWer <numeric_value>
```

```
DISPlay[:WINDow[1]|2]:ANALog:UPPer <numeric_value>
```



## DISPlay[:WINDow[1]]2:ANALog:LOWer &lt;numeric\_value&gt;

This command sets the analog meter lower scale limit.

**NOTE**

This command has the same purpose as DISPlay[:WINDow[1]]2:METER:LOWer <numeric\_value>.

The units used are dependent on the current setting of UNIT:POWer and CALCulate:RELative:STATE as shown in [Table 5-1](#).

**Table 5-1** Measurement units

Measurement Mode	Measurement Type	CALC:REL:STAT OFF		CALC:REL:STAT ON	
		Linear	Log	Linear	Log
<b>Single Channel</b>	Avg, Pk	Watt	dBm	%	dB
	Pk-Avg	%	dB	%	dB
<b>Ratio</b>	Avg, Pk, Pk-Avg	%	dB	%	dB
<b>Difference</b>	Avg, Pk	Watt	dBm	%	dB
	Pk-Avg	%	dB	%	dB

### Syntax

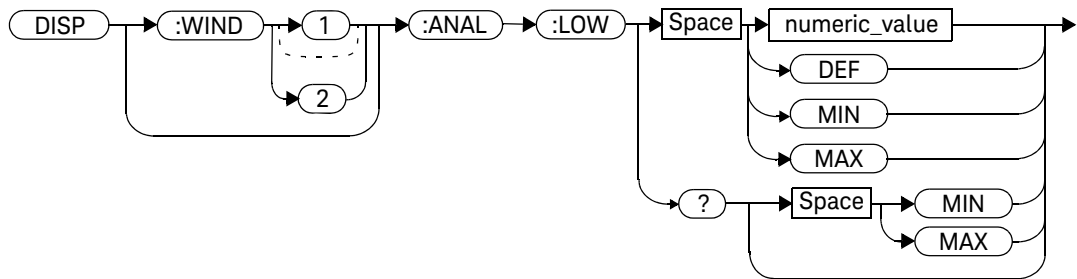

### Parameters

Item	Description/Default	Range of Values
numeric_value	A numeric value for the analog meter lower scale limit: – <b>DEF</b> : the default is –70 dBm – <b>MIN</b> : –150 dBm – <b>MAX</b> : 230 dBm  Units used are determined by the current setting of <b>UNIT:Power</b> and <b>CALCulate:RELative:STate</b> as shown in <a href="#">Table 5-1</a> .	–150 to 230 dBm  <b>DEF</b> <b>MIN</b> <b>MAX</b>

### Example

**DISP:WIND1:ANAL:LOW -50**

*This command sets the upper window's analog meter lower scale limit to –50 dBm.*

## Reset Condition

On reset, the value is set to  $-70$  dBm for both windows.

## Query

**DISPlay:[WINDow[1]|2]:ANALog:LOW? [MIN|MAX]**

The query returns the current setting of the analog meter's lower scale limit, or the value associated with **MIN** or **MAX**. The format of the response is **<NR3>**. The units in which the results are returned are determined by the current setting of **UNIT:Power** and **CALCulate:RELative:STATE** as shown in [Table 5-1](#).

## Query Example

**DISP:WIND1:ANAL:LOW?**

*This command queries the lower scale limit set on the analog meter in the upper window.*

## DISPlay[:WINDow[1]|2]:ANALog:UPPer &lt;numeric\_value&gt;

This command sets the analog meter upper scale limit.

**NOTE**

This command has the same purpose as DISPlay[:WINDow[1]|2]:METer:UPPer <numeric\_value>.

The units used are dependent on the current setting of UNIT:POWer and CALCulate:RELative:STATE as shown in [Table 5-2](#).

**Table 5-2** Measurement units

Measurement Mode	Measurement Type	CALC:REL:STAT OFF		CALC:REL:STAT ON	
		Linear	Log	Linear	Log
<b>Single Channel</b>	Avg, Pk	Watt	dBm	%	dB
	Pk-Avg	%	dB	%	dB
<b>Ratio</b>	Avg, Pk, Pk-Avg	%	dB	%	dB
<b>Difference</b>	Avg, Pk	Watt	dBm	%	dB
	Pk-Avg	%	dB	%	dB

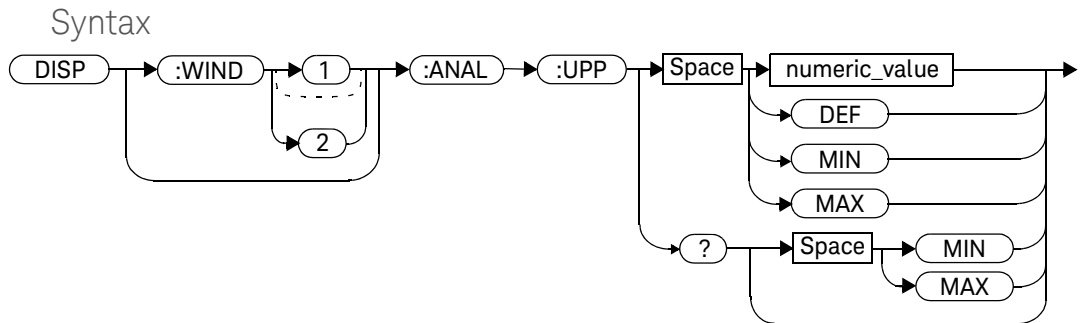

## Parameters

Item	Description/Default	Range of Values
numeric_value	A numeric value for the analog meter upper scale limit: – <b>DEF</b> : the default is 20 dBm – <b>MIN</b> : -150 dBm – <b>MAX</b> : 230 dBm  Units used are determined by the current setting of <b>UNIT:POWer</b> and <b>CALCulate:RELative:STATe</b> as shown in <a href="#">Table 5-2</a> .	-150 to 230 dBm  <b>DEF</b> <b>MIN</b> <b>MAX</b>

## Example

**DISP:WIND2:ANAL:UPP 50**

*This command sets the lower window's analog meter upper scale limit to 50 dBm.*

## Reset Condition

On reset, the upper scale limit is set to 20 dBm.

## Query

**DISP1ay:[WINDow[1]|2]:ANALog:UPPer? [MIN|MAX]**

The query returns the current setting of the analog meter's upper scale limit, or the value associated with **MIN** or **MAX**. The format of the response is **<NR3>**. The units in which the results are returned are determined by the current setting of **UNIT:POWer** and **CALCu1ate:RELative:STATe** as shown in [Table 5-2](#).

## Query Example

**DISP:WIND2:ANAL:UPP?**

*This command queries the upper scale limit set on the analog meter in the lower window.*

## DISPlay[:WINDow[1]][2]:FORMat <character\_data>

This command selects the format of the selected window.

### Syntax

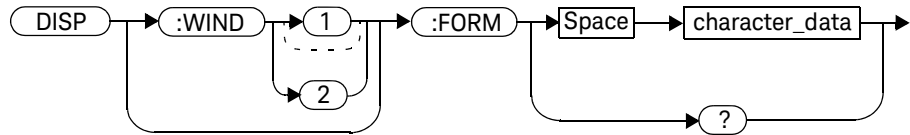

## Parameters

Item	Description/Default	Range of Values
character_data	Sets the window format: <ul style="list-style-type: none"> <li>- <b>DIGital</b>: sets the window display to digital. This setting is the same as SNUMeric.</li> <li>- <b>ANALog</b>: sets the window display to analog using the currently SElected measurement.</li> <li>- <b>SNUMeric</b>: sets the window display to single numeric. The currently SElected measurement is displayed. This setting is the same as DIGital.</li> <li>- <b>DNUMeric</b>: sets the window display to dual numeric.</li> <li>- <b>TRACe</b>: trace display using the currently SElected measurement. Used to determine the channel from which the trace is taken.</li> <li>- <b>CTABLe</b>: sets the window display to CCDF table.</li> </ul>	<b>DIGital</b> <b>ANALog</b> <b>SNUMeric</b> <b>DNUMeric</b> <b>TRACe</b> <b>CTABLe</b>

## Example

**DISP:WIND2:FORM DIG**

*This command sets the lower window to a digital display.*

## Reset Condition

On reset, the defaults for the upper and lower windows are **DIGital**.



## Query

**DISPlay:[WINDow[1]|2]:FORMat?**

The query returns the current format of the selected window.

## Query Example

**DISP:FORM?**

*This command queries the current format of the upper window.*

## Error Messages

- If the command is set to **TRACe** and the selected channel from which **TRACe** is taken has no sensor connected or has on a sensor other than a P-Series power sensor connected, error -241, “Hardware missing” occurs.
- If the command is set to **TRACe** and the selected channel has a P-Series power sensor connected in **AVERage** measurement mode, the error -221, “Settings conflict” occurs.

## DISPlay[:WINDow[1]|2]:METer Commands

These commands control the upper and lower scale limits of the analog meter.

The following commands are detailed in this section:

```
DISPlay[:WINDow[1]|2]:METer:LOWer <numeric_value>
```

```
DISPlay[:WINDow[1]|2]:METer:UPPer <numeric_value>
```

## DISPlay[:WINDow[1]|2]:METer:LOWer &lt;numeric\_value&gt;

This command sets the analog meter lower scale limit.

**NOTE**

This command has the same purpose as DISPlay[:WINDow[1]|2]:ANALog:LOWer <numeric\_value>.

The units used are dependent on the current setting of UNIT:POWer and CALCulate:RELative:STATE as shown in [Table 5-3](#).

**Table 5-3** Measurement units

Measurement Mode	Measurement Type	CALC:REL:STAT OFF		CALC:REL:STAT ON	
		Linear	Log	Linear	Log
<b>Single Channel</b>	Avg, Pk	Watt	dBm	%	dB
	Pk-Avg	%	dB	%	dB
<b>Ratio</b>	Avg, Pk, Pk-Avg	%	dB	%	dB
<b>Difference</b>	Avg, Pk	Watt	dBm	%	dB
	Pk-Avg	%	dB	%	dB

### Syntax

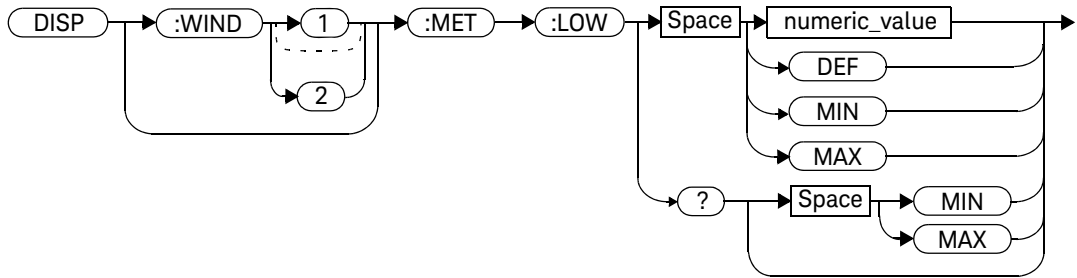

### Parameters

Item	Description/Default	Range of Values
numeric_value	A numeric value for the analog meter lower scale limit: – <b>DEF</b> : the default is 20 dBm – <b>MIN</b> : -150 dBm – <b>MAX</b> : 230 dBm  The default units are defined by <b>UNIT:POWer</b> and <b>CALCuLate:RELative:STAtE</b> .	-150 to 230 dBm  <b>DEF</b> <b>MIN</b> <b>MAX</b>

### Example

**DISP:WIND2:MET:LOW 10**

*This command sets the lower window's analog meter lower scale limit.*

## Reset Condition

On reset, the lower scale limit is set to  $-70$  dBm.

## Query

**DISPlay[:WINDow[1]|2]:METer:LOWer? [MIN|MAX]**

The query returns the current setting of the analog meter's lower scale limit or the value associated with **MIN** and **MAX**. The format of the response is **<NR3>**. The units in which the results are returned is dependent on the current setting of **UNIT:POWer** and **CALCuLate:RELative:STATE** as shown in [Table 5-3](#).

## Query Example

**DISP:MET:LOW?**

*This command queries the lower scale limit set on the analog meter in the upper window.*

## DISPlay[:WINDow[1]|2]:METer:UPPer &lt;numeric\_value&gt;

This command sets the analog meter upper scale limit.

**NOTE**

This command has the same purpose as DISPlay[:WINDow[1]|2]:ANALog:UPPer <numeric\_value>.

The units used are dependent on the current setting of UNIT:POWer and CALCulate:RELative:STATe as shown in [Table 5-4](#).

**Table 5-4** Measurement units

Measurement Mode	Measurement Type	CALC:REL:STAT OFF		CALC:REL:STAT ON	
		Linear	Log	Linear	Log
<b>Single Channel</b>	Avg, Pk	Watt	dBm	%	dB
	Pk-Avg	%	dB	%	dB
<b>Ratio</b>	Avg, Pk, Pk-Avg	%	dB	%	dB
<b>Difference</b>	Avg, Pk	Watt	dBm	%	dB
	Pk-Avg	%	dB	%	dB

## Syntax

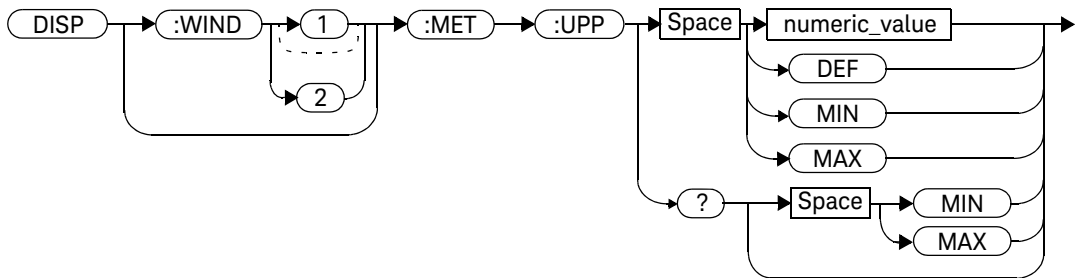

## Parameters

Item	Description/Default	Range of Values
numeric_value	A numeric value for the analog meter upper scale limit: - <b>DEF</b> : the default is 20 dBm - <b>MIN</b> : -150 dBm - <b>MAX</b> : 230 dBm  Units used are determined by the current setting of <b>UNIT:POWer</b> and <b>CALCulate:RELative:STate</b> as shown in <a href="#">Table 5-4</a> .	-150 to 230 dBm  <b>DEF</b> <b>MIN</b> <b>MAX</b>

## Example

```
DISP:WIND2:MET:UPP 20
```

*This command sets the lower window's analog meter upper scale limit.*

## Reset Condition

On reset, the upper scale limit is set to 20 dBm.

## Query

**DISP1ay[:WINDow[1]|2]:METer:UPPer? [MIN|MAX]**

The query returns the current setting of the analog meter's upper scale limit or the value associated with **MIN** and **MAX**. The format of the response is **<NR3>**. The units in which the results are returned is dependent on the current setting of **UNIT:POWer** and **CALCu1ate:RELative:STATe** as shown in the previous table.

## Query Example

**DISP:WIND2:MET:UPP?**

*This command queries the upper scale limit set on the analog meter in the lower window.*



# DISPlay[:WINDow[1]|2][:NUMeric[1]|2]:RESolution <numeric\_value>

This command sets the resolution of the measurement result in the specified window.

## Syntax

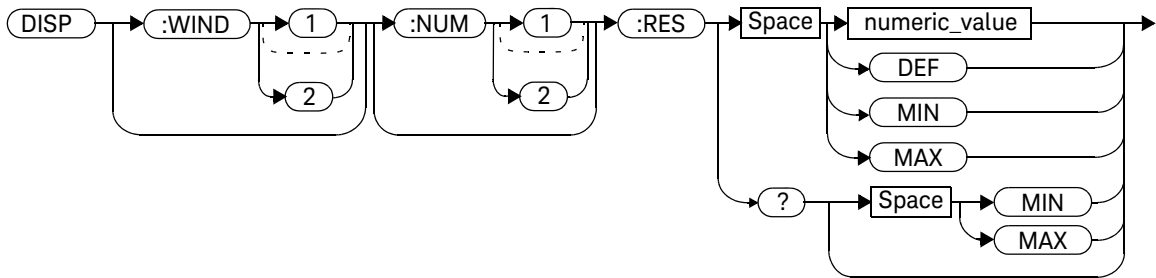

## Parameters

Item	Description/Default	Range of Values
numeric_value	A numeric value for the window resolution: – DEF: 3 – MIN: 1 – MAX: 4	1 to 4 DEF MIN MAX

## Example

**DISP:WIND2:RES 4**

*This command sets the lower window's resolution to four significant digits if the measurement result is linear, or to 0.001 if the measurement result is logarithmic.*

## Reset Condition

On reset, the resolution is set to 3.

## Query

**DISPlay[:WINDow[1]|2]:RESolution? [MIN|MAX]**

The query returns the current setting of the window's resolution or the value associated with **MIN** and **MAX**. The format of the response is **<NR1>**.

## Query Example

**DISP:WINDow1:NUMber2RES?**

*This command queries the resolution setting of the upper window/lower measurement.*

## DISPlay[:WINDow[1]]2]:SElect[1]]2

This command is used to select a specific measurement within a specific window. If the second numeric value is not sent, the upper measurement of the relevant window is selected. This command is used to specify which measurement is used for the analog, trace, or single numeric display.

### Syntax

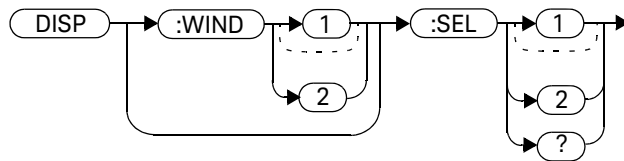

### Example

**DISP:WIND2:SEL1**

*This command selects the upper measurement in the lower window.*

### Reset Condition

On reset, the upper window upper measurement is selected.

## Query

**DISPlay[:WINDow[1]|2]:SElect[1]|2?**

The query enters a 1 or 0 into the output buffer indicating whether the window specified is currently selected.

- 1 is returned if the specified window is selected
- 0 is returned if the specified window is not selected

## Query Example

**DISP:SEL1?**

*This command queries whether or not the upper measurement in the upper window is selected.*

## DISPlay[:WINDow[1]]2[:STATe] <boolean>

This command enables/disables the upper or lower window (**WINDow1** and **WINDow2** respectively) so that the display shows a single window only. The displayed window is presented in expanded format, showing a single measurement only: either the single measurement that was shown on the window, or the currently selected measurement, if two measurements had been shown.

### Syntax

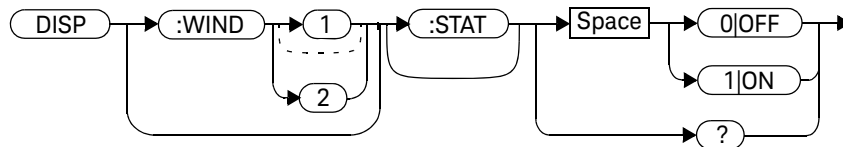

### Examples

**DISP:WIND2:STAT OFF**

*This command disables the lower window. The upper window is shown in expanded format, displaying its currently selected measurement.*

**DISP:WIND2:STAT ON**

*This command enables the lower window so that a dual window display is once more provided.*

### Reset Condition

On reset, both windows are enabled.

## Query

**DISPlay[:WINDow[1]|2]:STATe?**

This enters a 1 or 0 in the output buffer indicating the selected window.

- 1 is returned if the window is enabled
- 0 is returned if the window is disabled

## Query Example

**DISP:WIND2:STAT?**

*This command queries whether or not the lower window is displayed.*

DISPlay[:WINDow[1]|2]:TRACe:FEED <character\_data>

This command selects which channel's trace is displayed in the specified window.

### Syntax

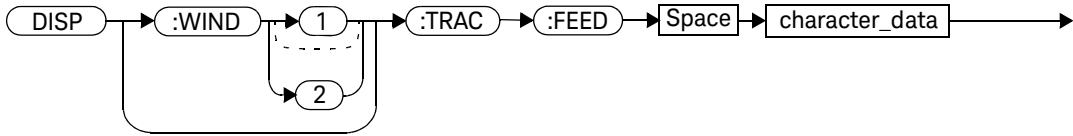

### Parameters

Item	Description/Default	Range of Values
character_data	Identifies which channel's trace is displayed. - <b>SENS1</b> : Channel A - <b>SENS2</b> : Channel B	"SENS1" "SENS2"

### Example

**DISP:WIND2:TRAC:FEED "SENS1"** *This command selects Channel A's trace to be displayed in the lower window.*



## Reset Condition

On reset, the value is set to:

- Upper window: **SENS1**
- Lower window (dual channel only): **SENS2**

## Query

**DISPlay:[WINDow[1]|2]:TRACe:FEED?**

The query returns the channel of the trace currently displayed in the specified window.

## Query Example

**DISP:WIND2:TRAC:FEED?**

*This command queries the channel of the trace currently displayed in the lower window.*

THIS PAGE HAS BEEN INTENTIONALLY LEFT BLANK.

# 6 FORMat Subsystem

FORMat Subsystem	276
FORMat[:READings]:BORDER <character_data>	277
FORMat[:READings][:DATA] <character_data>	279

This chapter explains how the **FORMat** subsystem is used to set a data format for transferring numeric information.

## FORMat Subsystem

The **FORMat** subsystem sets a data format for transferring numeric information. This data format is used only for response data by commands that are affected by the **FORMat** subsystem.

The queries affected are:

- FETCh?
- READ?
- MEASure?

The same **FORMat** is used on both channels.

Keyword	Parameter Form	Notes	Page
FORMat			
[:READings]			
:BORDer	<character_data>		page 277
[:DATA]	<character_data>		page 279

## FORMat[:READings]:BORDer <character\_data>

This command controls whether the binary data is transferred in normal or swapped Byte ORDer. It is only used when **FORMat[:READings][:DATA]** is set to **REAL**.

### Syntax

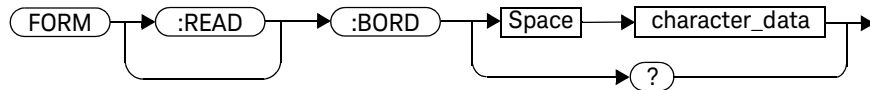

### Parameters

Item	Description/Default	Range of Values
character_data	Byte order of binary data transfer: – NORMa1 – SWAPped	NORMa1 SWAPped

### Example

**FORM:BORD SWAP**

*This command sets the byte order to swapped.*

### Reset Condition

On reset, this value is set to **NORMa1**.

## Query

**FORMat[:READings]:BORDER?**

The query returns the current setting of the byte order. The format of the response is **NORMa**l or **SWAPped**..

## Query Example

**FORM:BORD?**

*This command queries the current byte order setting.*

## FORMat[:READings][:DATA] <character\_data>

This command sets the data format for transferring numeric information to either **AScii** or **REAL**:

- When the format type is **AScii**, numeric data is output as ASCII bytes in the <NR3> format.
- When the format type is **REAL**, numeric data is output as IEEE 754 64 bit floating point numbers in a definite length block. The result is an 8 byte block per number. Each complete block is terminated by a line feed character.

The same **FORMat** is used on both channels.

**NOTE**

FORMat data formatting is not affected by TRACe subsystem data formatting.

### Syntax

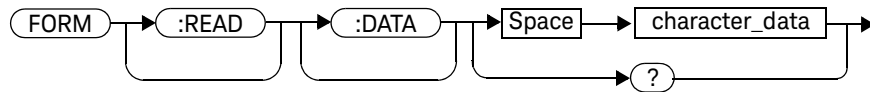

### Parameters

Item	Description/Default	Range of Values
character_data	Data format for transferring data: - <b>AScii</b> - <b>REAL</b>	<b>AScii</b> <b>REAL</b>

## Example

**FORM REAL**

*This command sets the format to **REAL**.*

## Reset Condition

On reset, the format is set to **ASCIi**.

## Query

**FORMat[:READings][:DATA]?**

The query returns the current setting of format: either **ASCIi** or **REAL**.

## Query Example

**FORM?**

*This command queries the current format setting.*



# 7 MEMory Subsystem

MEMory Subsystem	282
MEMory:CATalog Commands	284
MEMory:CATalog[:ALL]?	285
MEMory:CATalog:STATe?	287
MEMory:CATalog:TABLE?	288
MEMory:CLEar Commands	291
MEMory:CLEar[:NAME] <character_data>	292
MEMory:CLEar:TABLE	294
MEMory:FREE Commands	295
MEMory:FREE[:ALL]?	296
MEMory:FREE:STATe?	297
MEMory:FREE:TABLE?	298
MEMory:NStates?	299
MEMory:STATe Commands	300
MEMory:STATe:CATalog?	301
MEMory:STATe:DEFine <character_data>,<numeric_value>	302
MEMory:TABLE Commands	304
MEMory:TABLE:FREQuency <numeric_value>{,<numeric_value>}	305
MEMory:TABLE:FREQuency:POINts?	308
MEMory:TABLE:GAIN[:MAGNitude] <numeric_value>{,<numeric_value>}	309
MEMory:TABLE:GAIN[:MAGNitude]:POINts?	312
MEMory:TABLE:MOVE <character_data>,<character_data>	313
MEMory:TABLE:SElect <character_data>	314

This chapter explains how the **MEMory** command subsystem is used to create, edit and review sensor calibration tables.

## MEMory Subsystem

The **MEMory** command subsystem is used to:

- Edit and review sensor calibration tables (8480 Series sensors only)
- Store sensor calibration tables (8480 Series sensors only)
- Edit and review sensor frequency dependent offset tables
- Store sensor frequency dependent offset tables
- Edit and review sensor save/recall registers

Stored tables remain in the power meter's memory during power down. The power meter is capable of storing 20 sensor calibration tables and 10 frequency dependent offset tables of 80 frequency points each.

### NOTE

The MEMory subsystem is not used for E-Series and P-Series power sensors calibration tables. These are automatically downloaded to the power meter and cannot be reviewed or edited.

Keyword	Parameter Form	Notes	Page
<b>MEMory</b>			
<b>:CATalog</b>			
[ :ALL ]?		[query only]	<a href="#">page 285</a>
:STATe?		[query only]	<a href="#">page 287</a>
:TABLe?		[query only]	<a href="#">page 288</a>
<b>:CLEar</b>			
[ :NAME ]	<character_data>	[no query], [non-SCPI]	<a href="#">page 292</a>
:TABLe		[no query]	<a href="#">page 294</a>
<b>:FREE</b>			
[ :ALL ]?		[query only]	<a href="#">page 296</a>
:STATe?		[query only]	<a href="#">page 297</a>

Keyword	Parameter Form	Notes	Page
:TABLE?		[query only]	<a href="#">page 298</a>
:NSTates?		[query only]	<a href="#">page 299</a>
:STATE			
:CATalog?		[query only]	<a href="#">page 301</a>
:DEFine	<character_data> [, <numeric_value>]	[non-SCPI]	<a href="#">page 302</a>
:TABLE			
:FREQuency	<numeric_value> [, <numeric_value>]		<a href="#">page 305</a>
:POINts?		[query only]	<a href="#">page 308</a>
:GAIN			
[ :MAGNitude]	<numeric_value> [, <numeric_value>]	[non-SCPI]	<a href="#">page 309</a>
:POINts?		[query only], [non-SCPI]	<a href="#">page 312</a>
:MOVE	<character_data>, <character_data>	[no query], [non-SCPI]	<a href="#">page 313</a>
:SElect	<character_data>	[no query], [non-SCPI]	<a href="#">page 314</a>

## MEMory:CATalog Commands

These commands are used to query information on the current contents of a power meter's:

- Sensor calibration tables (8480 Series sensors only)
- Frequency dependent offset tables
- Save/recall registers

The following commands are detailed in this section:

**MEMory:CATalog[:ALL]?**

**MEMory:CATalog:STATe?**

**MEMory:CATalog:TABLE?**

## MEMory:CATalog[:ALL]?

This command lists stored sensor calibration tables (8480 Series sensors only), frequency dependent offset tables and save/recall registers.

The power meter returns the data in the form of two numeric parameters and as many strings as there are stored tables and save/recall registers:

`<numeric_value>,<numeric_value>{,<string>}`

- The first numeric parameter indicates the amount of memory, in bytes, used for the storage of tables and registers.
- The second numeric parameter indicates the memory, in bytes, available for the storage of tables and registers.
- Each string parameter returned indicates the name, type and size of a stored table or save/recall register:
  - `<string>`, `<type>`, `<size>`
  - `<string>` indicates the name of the table or save/recall register.
  - `<type>` indicates **TABL** for sensor calibration and frequency dependent offset tables, or **STAT** for a save/recall register.
  - `<size>` indicates the size of the table or save/recall register in bytes.

A sample of a response may look like the following:

```
1178,26230,"DEFAULT,TABL,14","8481A,TABL,116",
"8482A,TABL,74",....."State0,STAT,1619",
"State1,STAT,1619","State2,STAT,1619" .....
```

The power meter is shipped with a set of predefined sensor calibration tables. The data in these sensor calibration tables is based on statistical averages for a range of Keysight Technologies power sensors. These tables can be edited. The predefined data is listed in your *User's Guide*. These power sensors and table numbers are listed in [Table 7-1](#).

**Table 7-1** 8480 Series power sensor tables

Table	Power Sensor	Table Name
0	None	DEFAULT <sup>[a]</sup>
1	8481A	8481A
2	8482A, 8482B, 8482H	8482A
3	8483A	8483A
4	8481D	8481D
5	8485A	8485A
6	R8486A	R8486A
7	Q8486A	Q8486A
8	R8486D	R8486D
9	8487A	8487A

[a] There are also ten sensor calibration tables named CUSTOM\_0 through CUSTOM\_9 and ten frequency dependent offset tables named CUSTOM\_A through CUSTOM\_J which do not contain any data when the power meter is shipped from the factory.

### Syntax

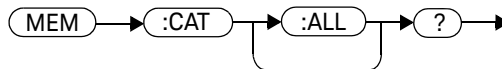

### Example

**MEM:CAT?**

*This command queries the list of tables and save/recall registers.*

## MEMory:CATalog:STATe?

This command is used to list the save/recall registers.

The power meter returns the data in the form of two numeric parameters and as many strings as there are save/recall registers.

`<numeric_value>,<numeric_value>{,<string>}`

- The first numeric parameter indicates the amount of memory, in bytes, used for the storage of registers.
- The second parameter indicates the memory, in bytes, available for the storage of registers.
- Each string parameter returned indicates the name, type and size of a save/recall register:
  - `<string>,<type>,<size>`
  - `<string>` indicates the name of the save/recall register.
  - `<type>` indicates **STAT** for save/recall register.
  - `<size>` indicates the size of the save/recall register in bytes.

For example, a sample of a response may look like:

`0,16190,"State0,STAT,0","State1,STAT,0" .....`

### Syntax



### Example

**MEM:CAT:STAT?**

*This command queries the list of save/recall registers.*

## MEMory:CATalog:TABLE?

This command is used to list the stored sensor calibration (8480 Series sensors only) and frequency dependent offset tables.

The power meter returns the data in the form of two numeric parameters and as many strings as there are stored tables.

**<numeric\_value>,<numeric\_value>{,<string>}**

- The first numeric parameter indicates the amount of memory, in bytes, used for the storage of tables.
- The second parameter indicates the memory, in bytes, available for the storage of tables.
- Each string parameter returned indicates the name, type and size of a stored table:
  - **<string>,<type>,<size>**
  - **<string>** indicates the name of the table.
  - **<type>** indicates **TABL** for a table.
  - **<size>** indicates the size of the table in bytes.

For example, a sample of a response may look like:

**1178,10040,"DEFAULT,TABL,14","8481A,TABL,116",  
"8482A,TABL,74","8483A,TABL,62".....**

The power meter is shipped with a set of predefined sensor calibration tables. The data in these sensor calibration tables is based on statistical averages for a range of Keysight Technologies power sensors. These tables can be edited. The predefined data is listed in your *User's Guide*. These power sensors and table numbers are listed in [Table 7-2](#).



**Table 7-2** 8480 Series power sensor tables

Table	Power Sensor	Table Name
0	None	DEFAULT <sup>[a]</sup>
1	8481A	8481A
2	8482A, 8482B, 8482H	8482A
3	8483A	8483A
4	8481D	8481D
5	8485A	8485A
6	R8486A	R8486A
7	Q8486A	Q8486A
8	R8486D	R8486D
9	8487A	8487A

[a] Default is a sensor calibration table in which the reference calibration factor and calibration factors are 100%. This sensor calibration table can be used during the performance testing of the power meter

There are also ten sensor calibration tables named CUSTOM\_0 through CUSTOM\_9 and ten frequency dependent offset tables named CUSTOM\_A through CUSTOM\_J which do not contain any data when the power meter is shipped from the factory.

## Syntax

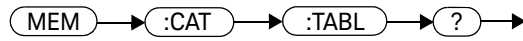

## Example

**MEM:CAT:TABL?**

*This command queries the list of stored tables.*

## MEMory:CLEar Commands

These commands are used to remove the contents stored in the sensor calibration tables (8480 Series sensors only), frequency dependent offset tables and save/recall registers. This subsystem removes the data contents but does not affect the name of the associated table or save/recall register.

The following commands are detailed in this section:

**MEMory:CLEar:[NAME] <character\_data>**

**MEMory:CLEar:TABLE**

**NOTE**

The contents cleared using these commands are non-recoverable.

---

## MEMory:CLEar[:NAME] <character\_data>

This command clears the contents of a specified sensor calibration table (8480 Series sensors only), frequency dependent offset table, or save/recall register.

Although the table remains, a **MEMory:TABLE:FREQUENCY|GAIN:POINTS?** query returns a 0 as there are no contents in the table.

For sensor calibration tables and frequency dependent offset tables, this command is an alternative form of the **MEMory:CLEar:TABLE** command, the only difference being the method in which the table is selected.

### NOTE

The contents cleared using this command are non-recoverable.

---

## Syntax

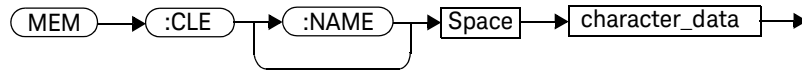

## Parameters

Item	Description/Default	Range of Values
character_data	Contains an existing table name or save/recall register.	Any existing table name or save/recall register.

## Example

**MEM:CLE "8485A"**

*This command clears the contents of sensor calibration table 8485A.*

## Error Messages

If the table or save/recall register name does not exist, error -224, "Illegal parameter value" occurs.

## MEMory:CLEar:TABLE

This command is used to clear the contents of the table currently selected using **MEMory:TABLE:SElect**. Although the table remains, a **MEMory:TABLE:FREQuency|GAIN:POINts?** query returns a 0 as the table contents are empty.

This command is an alternative form of the **MEMory:CLEar[:NAME]** command. The difference is the method in which the table is selected.

**NOTE**

The contents cleared using this command are non-recoverable.

---

### Syntax



### Example

**MEM:CLE:TABLE**

*This command clears the contents of the currently selected table.*

### Error Message

If no table is selected, error -221, "Settings conflict" occurs.

## MEMory:FREE Commands

These commands are used to return information on the amount of free memory space available for sensor calibration tables (8480 Series sensors only), frequency dependent offset tables, and save/recall registers.

The following commands are described in this section:

**MEMory:FREE[:ALL]?**

**MEMory:FREE:STATe?**

**MEMory:FREE:TABLE?**

## MEMory:FREE[:ALL]?

This query returns the amount of memory free for sensor calibration tables (8480 Series sensors only), frequency dependent offset tables, and save/recall registers. The format of the response is:

<bytes\_available>,<bytes\_in\_use>

## Syntax

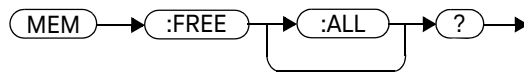

## Example

**MEM:FREE?**

*This command queries the amount of free memory in total.*



## MEMory:FREE:STATe?

This query returns the amount of memory free for save/recall registers. The format of the response is:

`<bytes_available>,<bytes_in_use>`

### Syntax

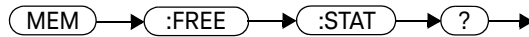

### Example

**MEM:FREE:STAT?**

*This command queries the amount of free memory for save/recall registers.*

## MEMory:FREE:TABLE?

This query returns the amount of memory free for sensor calibration tables (8480 Series sensors only) and frequency dependent offset tables. The format of the response is:

<bytes\_available>,<bytes\_in\_use>

## Syntax

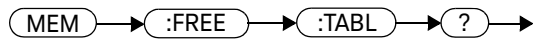

## Example

**MEM:FREE:TABLE?**

*This command queries the amount of free memory for tables.*

## MEMory:NStates?

This query returns the number of registers that are available for save/recall. As there are ten registers this query always returns ten.

### Syntax



### Example

**MEM:NSTAT?**

*This command queries the number of registers available for save/recall.*

## MEMory:STATe Commands

These commands are used to query and define register names.

The following commands are described in this section:

**MEMory:STATe:CATalog?**

**MEMory:STATe:DEFine**

## MEMory:STATe:CATalog?

This query returns a list of the save/recall register names in ascending order of register number. The format of the response is:

<string>,<string>,. . . .,<string>

### Syntax

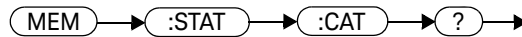

### Example

**MEM:STAT:CAT?**

*This command queries the register names.*

## MEMory:STATe:DEFine &lt;character\_data&gt;,&lt;numeric\_value&gt;

This command is used to associate a name with a save/recall register number.

## Syntax

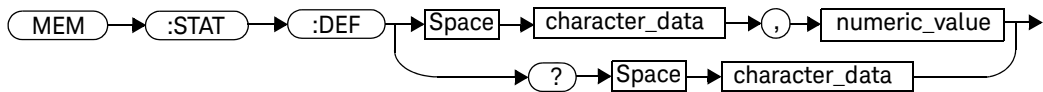

## Parameters

Item	Description/Default	Range of Values
character_data	Details the register name. A maximum of 12 characters can be used.	A to Z (uppercase) a to z (lowercase) 0-9 _ (underscore)
numeric_value	A numeric value (<NRf>) for the register number.	0 to 9

## Example

**MEM:STAT:DEF "SETUP1",4**      *This command names register 4 SETUP1.*

## Query

**MEMory:STATe:DEFine? <string>**

The query returns the register number for the given register name.

## Query Example

**MEM:STAT:DEF? "SETUP1"**

*This command queries the register number of SETUP1.*

## Error Messages

- If the register number is out of range, error -222, "Data out of range" occurs.
- If the name is invalid, error -224, "Illegal parameter value" occurs.
- If a register or sensor calibration table with the same name already exists, error -257, "File name error" occurs (command only).

## MEMory:TABLE Commands

These commands are used to define a sensor calibration table (8480 Series sensors only) or a frequency dependent offset table, and to write to and read data from it.

The following commands are described in this section:

```
MEMory:TABLE:FREQuency <numeric_value>{,<numeric_value>}
```

```
MEMory:TABLE:FREQuency:POINts?
```

```
MEMory:TABLE:GAIN[:MAGNitude]  
<numeric_value>{,<numeric_value>}
```

```
MEMory:TABLE:GAIN[:MAGNitude]:POINts?
```

```
MEMory:TABLE:MOVE <character_data>,<character_data>
```

```
MEMory:TABLE:SELEct <character_data>
```



## MEMory:TABLE:FREQUENCY &lt;numeric\_value&gt;{,&lt;numeric\_value&gt;}

This command is used to enter frequency data into the current selected table. Any previous frequency list is cleared before the new frequency list is stored. The frequencies must be entered in ascending order. Entries in the frequency lists correspond as shown in [Table 7-3](#) with entries in the calibration/offset factor lists.

**NOTE**

For sensor calibration tables only, the first calibration factor entered using the MEMory:TABLE:GAIN command is used as the reference calibration factor.

**Table 7-3** Frequency and Calibration/Offset factor list

Table	Power Sensor	Table Name
0	None	DEFAULT <sup>[a]</sup>
1	8481A	8481A
2	8482A, 8482B, 8482H	8482A
3	8483A	8483A
4	8481D	8481D
5	8485A	8485A
6	R8486A	R8486A
7	Q8486A	Q8486A
8	R8486D	R8486D
9	8487A	8487A

[a] Default is a sensor calibration table in which the reference calibration factor and calibration factors are 100%. This sensor calibration table can be used during the performance testing of the power meter.

For sensor calibration tables (8480 Series sensors only), the number of frequency points must be one less than the number of calibration factor points. This is verified when the sensor calibration table is selected using

**SENSe:CORRection:CSET:SELEct <string>**.

Ensure that the frequency points you use cover the frequency range of the signals that you want to measure. If you measure a signal with a frequency outside the frequency range defined in the table, then the power meter uses the highest or lowest point in the table to calculate the calibration factor/offset.

Depending on available memory, the power meter is capable of storing 20 sensor calibration tables and 10 frequency dependent offset tables, each containing 80 points.

## Syntax

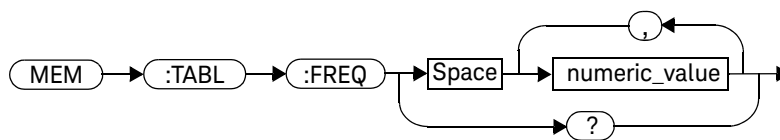

## Parameters

Item	Description/Default	Range of Values
numeric_value	A numeric value for the frequency. The default units are Hz.	1 kHz to 1000.0 GHz <sup>[a],[b]</sup>

[a] The following measurement units can be used:

Hz

kHz (10<sup>3</sup>)

MHz (10<sup>6</sup>)

GHz (10<sup>9</sup>)

[b] All frequencies are truncated to a multiple of 1 kHz.

## Example

**MEM:TABL:FREQ 200kHz,600kHz** *This command enters frequencies of 200 kHz and 600 kHz into the currently selected table.*

## Query

**MEMory:TABLE:FREQuency?**

The query returns a list of frequency points for the table currently selected. The frequencies are returned in Hz.

## Query Example

**MEM:TABL:FREQ?** *This command queries the frequency points in the currently selected table.*

## Error Messages

- If more than 80 frequencies are in the list, error –108, “Parameter not allowed” occurs.
- If the frequencies are not entered in ascending order, error –220, “Parameter error;Frequency list must be in ascending order” occurs.
- If a table has not been specified using the **MEMory:TABLE:SElect** command, the data cannot be entered into the table and error –221, “Settings conflict” occurs.
- If a frequency is sent which is outside of the allowed frequency range, error –222, “Data out of range” occurs.

## MEMory:TABLE:FREQuency:POINts?

This query returns the number of frequency points for the table currently selected. The response format is **<NRf>**. If no frequency values have been set, this command returns 0. If no table is selected, this command returns **NAN**.

### Syntax



### Example

**MEM:TABLE:FREQ:POIN?**

*This command queries the number of frequency points in the current table.*

MEMory:TABLE:GAIN[:MAGNitude]  
 <numeric\_value>{,<numeric\_value>}

This command is used to enter calibration factors into the sensor calibration table (8480 Series sensors only) or offsets into the frequency dependent offset table, currently selected using **MEMory:TABLE:SElect**. Any previous calibration factor list, or offset list is cleared before the new calibration factors/offsets are stored.

A maximum of 81 parameters for sensor calibration tables and 80 parameters for frequency dependent offset tables can be sent with this command. For sensor calibration tables only, the first parameter is the reference calibration factor, each subsequent parameter is a calibration factor point in the sensor calibration table.

Entries in the frequency lists correspond as shown in [Table 7-4](#) with entries in the calibration/offset factor lists.

**Table 7-4** Frequency and Calibration/Offset factor list

Frequency	Calibration Factor/Offset
-	Reference Calibration Factor (For Sensor Calibration Tables)
Frequency 1	Calibration Factor/Offset 1
"	"
Frequency 80	Calibration Factor/Offset 80

For sensor calibration tables the number of frequency points must be one less than the number of calibration factor data points. This is verified when the sensor calibration table is selected using **SENSe:CORRection:CSET1:SElect <string>**.

## Syntax

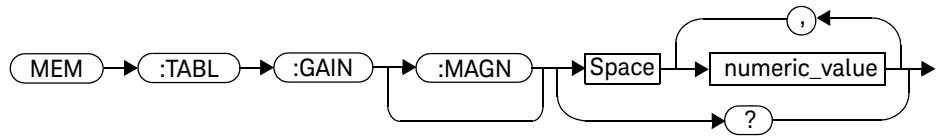

## Parameters

Item	Description/Default	Range of Values
numeric_value	A numeric value for the calibration/ offset factors. The units are PCT.	1.0 to 150.0

## Example

```
MEM:TABLE:SEL "Sensor_1"
MEM:TABLE:GAIN 97,99.5,97.4
```

*This command enters a reference calibration factor of 97 % and calibration factors of 99.5 % and 97.4 % into the sensor calibration table.*

## Query

```
MEMory:TABLE:GAIN[:MAGNitude]?
```

The query returns a list of calibration factor/offset points for the currently selected table.

## Query Example

**MEM:TABLE:GAIN?**

*This command queries the calibration factor/  
offset in the current table.*

## Error Messages

- If more than 81 calibration factors for sensor calibration tables, or 80 offsets for frequency dependent offset tables are in the list, error -108, "Parameter not allowed" occurs.
- If a table is not specified using the **MEMory:TABLE:SElect** command, the data cannot be entered and error -221, "Settings conflict" occurs.
- If any of the calibration/offset factors are outside of the allowed range, error -222, "Data out of range" occurs.

## MEMory:TABLE:GAIN[:MAGNitude]:POINts?

This query is used to return the number of calibration factor/offset points for the currently selected table. If the currently selected table is a sensor calibration table (8480 Series sensors only), the reference calibration factor is included

If no values have been set, 0 is returned. If no table is selected, **NAN** is returned.

## Syntax

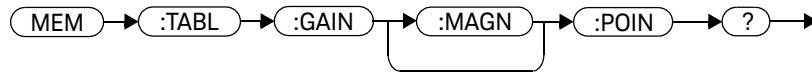

## Example

**MEM:TABL:GAIN:POIN?**

*This command queries the number of calibration factor/offset points in the current table.*



## MEMory:TABLE:MOVE <character\_data>,<character\_data>

This command is used to rename a sensor calibration table (8480 Series Sensors only) or a frequency dependent offset table.

### Syntax



### Parameters

Item	Description/Default	Range of Values
character_data (1st parameter)	Contains the existing table name.	existing table name
character_data (2nd parameter)	Details the new table name. A maximum of 12 characters can be used.	A to Z (uppercase) a to z (lowercase) 0 - 9 _ (underscore)

### Example

**MEM:TABLE:MOVE "tab1","tab1a"** *This command renames a table named tab1 to tab1a.*

### Error Messages

- If either table name is invalid, error -224, "Illegal parameter value" occurs.
- If the first parameter does not match an existing table name, error -256, "File name not found" occurs.
- If the second parameter matches an existing table name or save/recall register, error -257, "File name error" occurs.

## MEMory:TABLE:SElect &lt;character\_data&gt;

This command is used to activate either a sensor calibration table (8480 Series sensors only), or a frequency dependent offset table. A table must be activated before any operation can be performed on it.

## Syntax

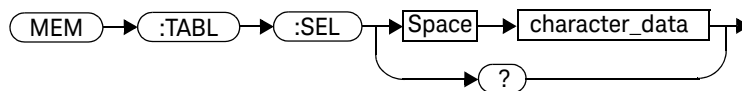

## Parameters

Item	Description/Default	Range of Values
character_data	Details the new table name. A maximum of 12 characters can be used.	A to Z (uppercase) a to z (lowercase) 0 - 9 _ (underscore)

## Example

**MEM:TABLE:SEL "Sensor1"**

*This command selects a sensor calibration table named "Sensor1".*

## Query

**MEMory:TABLE:SElect?**

The query returns the name of the currently selected table.

# 8 OUTPUT Subsystem

OUTPut Subsystem	316
OUTPut:RECOOrder[1]2:FEED <data_handle>	317
OUTPut:RECOOrder[1]2:LIMit:LOWer <numeric_value>	319
OUTPut:RECOOrder[1]2:LIMit:UPPer <numeric_value>	321
OUTPut:RECOOrder[1]2:STATe <boolean>	323
OUTPut:ROSCillator[:STATe] <boolean>	324
OUTPut:TRIGger[:STATe] <boolean>	325

This chapter explains how the **OUTPut** command subsystem is used to switch the POWER REF output on and off.

## OUTPut Subsystem

The **OUTPut** command subsystem is used to control the trigger output, switch on and off the POWER REF output, and controls the recorder output.

Keyword	Parameter Form	Notes	Page
OUTPut			
:REcorder[1] 2			
:FEED	<data_handle>		<a href="#">page 317</a>
:LIMit			
:LOWer	<numeric_value>		<a href="#">page 319</a>
:UPPer	<numeric_value>		<a href="#">page 321</a>
:STATe	<boolean>		<a href="#">page 323</a>
:ROScillator			
[ :STATe]	<boolean>		<a href="#">page 324</a>
:TRIGger			
[ :STATe]	<boolean>		<a href="#">page 325</a>

## OUTPut:RECOder[1]|2:FEED <data\_handle>

This command specifies which measurement is sent to the recorder output specified by the numeric value following **RECOder**, **RECOder1** and **RECOder2**.

### Syntax

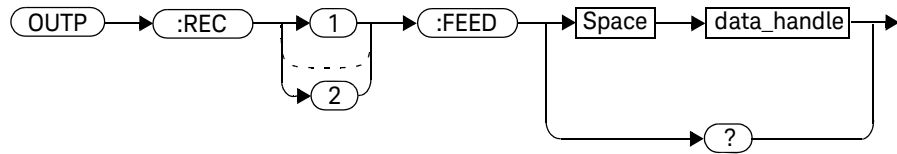

### Parameters

Item	Description/Default	Range of Values
data_handle	The CALC block specifying the measurement to be sent to the recorder output.	"CALC1" or "CALC" "CALC2" "CALC3" "CALC4"

### Example

**OUTPut:REC2:FEED "CALC1"**

*This command sends the CALC1 measurement to recorder output 2.*

### Reset Condition

On reset, **data\_handle** is set to its previous value.

## 8 OUTPut Subsystem

### Query

**OUTPut:REcorder[1]|2:FEED?**

The query command returns the current value of data\_handle.

### Query Example

**OUTP:REC2:FEED?**

*This command queries the value of data\_handle for recorder output 2.*

## OUTPut:RECOder[1]|2:LIMit:LOWer <numeric\_value>

This command sets the minimum scaling value for the specified recorder output. The units used are dependent on the units currently set for the CALC block specified in **OUTPut:RECOder[1]|2:FEED <data\_handle>**.

### Syntax

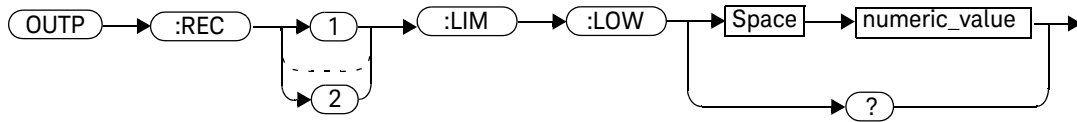

### Parameters

Item	Description/Default	Range of Values
numeric_value	A numeric value for the minimum scaling value. The units used—dBm, W or %—are dependent on the units currently set for the CALC block specified in <b>OUTPut:RECOder[1] 2:FEED &lt;data_handle&gt;</b> .	-150 to +230 dBm 1 aW to 100 XW 0 % to 999 %

### Example

**OUTPut:REC:LIM:LOW -90**

*This command sets the minimum scaling value to -90.*

### Reset Condition

On reset, the minimum scaling value is set to -150 dBm.

## Query

**OUTPut:RECOder[1]|2:LIMit:LOWer?**

The query command returns the minimum scaling value.

## Query Example

**OUTP:REC:LIM:LOW?**

*This command returns the minimum scaling value for the specified recorder output.*



## OUTPut:RECOder[1]|2:LIMit:UPPer <numeric\_value>

This command sets the maximum scaling value for the specified recorder output. The units used are dependent on the units currently set for the CALC block specified in **OUTPut:RECOder[1]|2:FEED <data\_handle>**.

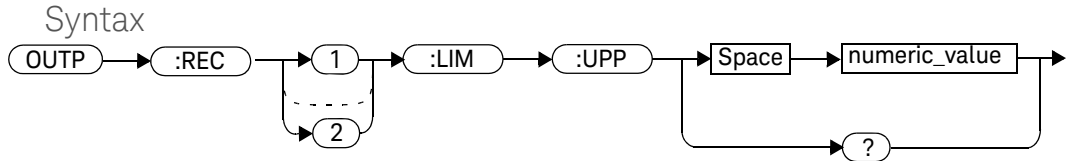

### Parameters

Item	Description/Default	Range of Values
numeric_value	A numeric value for the minimum scaling value. The units used—dBm, W or %—are dependent on the units currently set for the CALC block specified in <b>OUTPut:RECOder[1] 2:FEED &lt;data_handle&gt;</b> .	-150 to +230 dBm 1 aW to 100 XW 0 % to 999 %

### Example

**OUTPut:REC:LIM:UPP 10**

*This command sets the maximum scaling value to 10.*

### Reset Condition

On reset, the maximum scaling value is set to +20 dBm.

## Query

**OUTPut:REcorder[1]|2:LIMit:UPPer?**

The query command returns the maximum scaling value.

## Query Example

**OUTP:REC:LIM:UPP?**

*This command returns the maximum scaling value for the specified recorder output.*

## OUTPut:RECOder[1]|2:STATe <boolean>

This command enables or disables the specified recorder output.

### Syntax

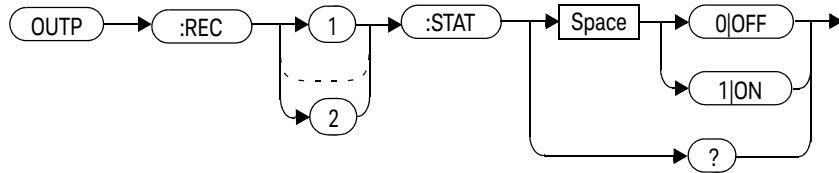

### Example

**OUTPut:REC1:STAT 1**

*This command enables the specified recorder output.*

### Reset Condition

On reset, the recorder output is **OFF**.

### Query

**OUTPut:RECOder[1]|2:STATe?**

The query command enters a 1 or 0 into the output buffer indicating whether or not the specified recorder is switched on.

- 1 is returned when the recorder output is switched **ON**
- 0 is returned when the recorder output is switched **OFF**

### Query Example

**OUTPut:REC2:STAT?**

*This command queries the status of the recorder output.*

## OUTPut:ROSCillator[:STATe] <boolean>

This command enables/disables the POWER REF output.

### Syntax

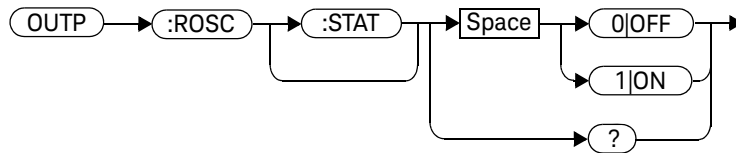

### Example

**OUTPut:ROSC:STAT 1)**

*This command enables the POWER REF output.*

### Reset Condition

On reset, the POWER REF output is disabled.

### Query

**OUTPut:ROSCillator[:STATe]?**

The query command enters a 1 or 0 into the output buffer indicating whether or not the POWER REF is enabled.

- 1 is returned when the POWER REF output is enabled
- 0 is returned when the POWER REF output is disabled

### Query Example

**OUTPut:ROSC?**

*This command queries the status of the POWER REF output.*

## OUTPut:TRIGger[:STATe] <boolean>

This command enables/disables the trigger output signal.

### Syntax

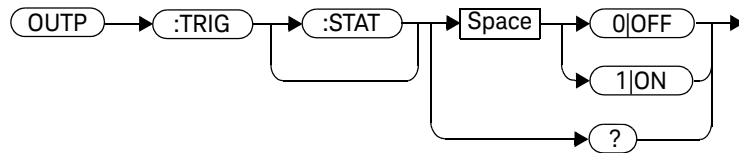

### Example

**OUTPut:TRIG:STAT 1**

*This command enables the trigger output signal.*

### Reset Condition

On reset, the trigger output signal is disabled.

### Query

**OUTPut:TRIGger[:STATe]?**

The query command enters a 1 or 0 into the output buffer indicating whether or not the trigger output signal is enabled/disabled.

- 1 is returned when the trigger output signal is enabled
- 0 is returned when the trigger output signal is disabled

### Query Example

**OUTPut:TRIG:STAT?**

*This command queries the status of the trigger output signal.*

THIS PAGE HAS BEEN INTENTIONALLY LEFT BLANK.

# 9 PStatistic Subsystem

PStatistic[1] 2:CCDF:DATA?	329
PStatistic[1] 2:CCDF:DATA:MAX <numeric_value>	331
PStatistic[1] 2:CCDF:POWER? <numeric_value>	333
PStatistic[1] 2:CCDF:PROBability? <numeric_value>	335
PStatistic[1] 2:CCDF:TABLE?	337

Chapter 9 explains how the **PStatistic** command subsystem is used to configure the settings of Complementary Cumulative Distribution Function (CCDF).

## PStatistic Subsystem

The **PStatistic** subsystem is used to configure the settings of Complementary Cumulative Distribution Function (CCDF).

Keyword	Parameter Form	Notes	Page
<b>PStatistic[1]   2</b>			
<b>:CCDF</b>			
<b>:DATA?</b>		[query only]	<a href="#">page 329</a>
<b>:MAX</b>	<numeric_value>		<a href="#">page 331</a>
<b>:POWer?</b>	<numeric_value>	[query only]	<a href="#">page 333</a>
<b>:PROBability?</b>	<numeric_value>	[query only]	<a href="#">page 335</a>
<b>:TABle?</b>		[query only]	<a href="#">page 337</a>



## PSTatistic[1]|2:CCDF:DATA?

This command is used to return 501 probability values in % at different power level within certain range, starts from 0 dB till the predefined maximum power level.

### NOTE

The maximum power level can be set by using this command:  
**PSTatistic[1]|2:CCDF:DATA:MAX <numeric\_value>**

By default, the maximum value is 50 dB.

The power interval between each reading (probability value) is determined by the defined maximum power level divided by 500.

### NOTE

This command is only applicable when P-Series sensors are present and the following conditions are met:

- Free run acquisition mode is selected
- NORMAl or DOUBle measurement speed setting is chosen

### Syntax



### Example

**PST1:CCDF:DATA?**

*This command returns 501 probability values in % at different power levels within certain range (from 0 dB to maximum power level defined).*

## Error Messages

- If no power sensor is connected, error -241 "Hardware missing" occurs.
- If sensor/s connected are not P-Series sensors, error -241 "Hardware missing" occurs.
- If measurement speed setting is **FAST**, error -221 "Settings conflict" occurs.
- If the acquisition mode is in continuous triggering or triggering source is set to either **INT1**, **INT12**, or **EXT**, error -221 "Settings conflict" occurs.

## PSTatistic[1]|2:CCDF:DATa:MAX <numeric\_value>

This command is used to set the maximum value of X-axis CCDF trace.

### Syntax

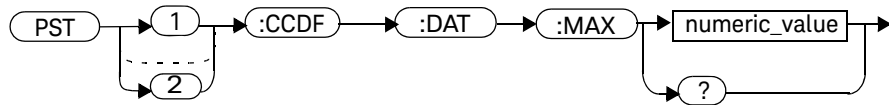

### Parameters

Item	Description/Default	Range of Values
numeric_value	X-axis CCDF trace maximum value in dB. - Minimum value: 5.00 dB - Maximum value: 50.00 dB	5.00 to 50.00

### Example

**PST1:CCDF:DAT:MAX 10**

*This command sets the maximum value of X-axis CCDF trace to 10 dB.*

### Reset Condition

On reset, the maximum value for CCDF trace X-axis is set to 50 dB.

## Query

**PStatistic[1]|2:CCDF:DATA:MAX?**

The query returns the X-axis CCDF trace maximum value.

## Query Example

**PST1:CCDF:DAT:MAX?**

*This command queries the maximum value of X-axis CCDF trace for Channel A.*

## Error Messages

- If the parameter set is less than 5.0, error -222 "Data out of range; value clipped to lower limit" occurs.
- If the parameter set is more than 50.0, error -222 "Data out of range; value clipped to upper limit" occurs.

## PStatistic[1]|2:CCDF:POW? <numeric\_value>

This command is used to return the power level at the specified probability.

### NOTE

This command is only applicable when P-Series sensors are present and the following conditions are met:

- Free run acquisition mode is selected
- NORMa1 or DOUB1e measurement speed setting is chosen

### Syntax

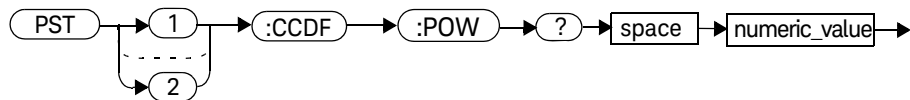

### Parameters

Item	Description/Default	Range of Values
numeric_value	The probability at the queried power. - Maximum value: 0 % - Minimum value: 100 %	0.0 to 100

### Example

**PST1:CCDF:POW? 30**

*This command queries the power level at probability of 30 %.*

## Error Messages

- If no power sensor is connected, error -241 "Hardware missing" occurs.
- If sensor/sensors connected are not P-Series sensors, error -241 "Hardware missing" occurs.
- If measurement speed setting is **FAST**, error -221 "Settings conflict" occurs.
- If the acquisition mode is in continuous triggering or triggering source is set to either **INT1**, **INT2**, or **EXT**, error -221 "Setting conflict" occurs.
- If the parameter specified is less than 0.0 or more than 100.0, error -220 "Parameter error" occurs.
- If no parameter is specified, error -109 "Missing parameter" occurs.

## PStatistic[1]|2:CCDF:PROBability? <numeric\_value>

This command is used to return the probability at the specified power level.

### NOTE

This command is only applicable when P-Series sensors are present and the following conditions are met:

- Free run acquisition mode is selected
- NORMa1 or DOUB1e measurement speed setting is chosen

### Syntax

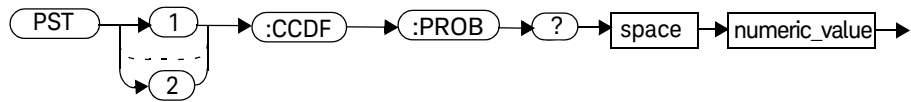

### Parameters

Item	Description/Default	Range of Values
numeric_value	The power level at the queried probability. - Maximum value: 50.00 dB - Minimum value: 0.00 dB	0.00 to 50.0

## Example

**PST1:CCDF:PROB? 50**

*This command queries the probability at the power level of 50dB for Channel A.*

## Error Messages

- If no power sensor is connected, error -241 "Hardware missing" occurs.
- If sensor/sensors connected are not P-Series sensors, error -241 "Hardware missing" occurs.
- If measurement speed setting is **FAST**, error -221 "Settings conflict" occurs.
- If the acquisition mode is in continuous triggering or triggering source is set to either **INT1**, **INT2**, or **EXT**, error -221 "Setting conflict" occurs.
- If the parameter specified is less than 0.0 or more than 50.0, error -220 "Parameter error" occurs.
- If no parameter is specified, error -109 "Missing parameter" occurs.



## PStatistic[1]|2:CCDF:TABLE?

This command is used to return the data in CCDF table, average input power, probability at the average input power, peak to average power ratio and sample count.

### NOTE

This command will return 10 scalar results in the following order:

- 1 Average input power (in dBm)
  - 2 Probability at the average input power (in %)
  - 3 Power level (power to average power ratio) that has 10 % of the power (in dB)
  - 4 Power level (power to average power ratio) that has 1 % of the power (in dB)
  - 5 Power level (power to average power ratio) that has 0.1 % of the power (in dB)
  - 6 Power level (power to average power ratio) that has 0.01 % of the power (in dB)
  - 7 Power level (power to average power ratio) that has 0.001 % of the power (in dB)
  - 8 Power level (power to average power ratio) that has 0.0001 % of the power (in dB)
  - 9 Peak to average power ratio (in dB)
  - 10 Sample count
- 

### NOTE

This command is only applicable when P-Series sensors are present and the following conditions are met:

- Free run acquisition mode is selected
  - NORMal or DOUBle measurement speed setting is chosen
-

## Syntax



## Example

**PST :CCDF :TAB?**

*This command returns the data in CCDF table: average input power, probability at the average input power, power level at various predefined probability steps (10 %, 1 %, 0.1 %, 0.01 %, 0.001 % and 0.0001 %), peak to average power ratio and sample count for Channel A.*

**PST2 :CCDF :TAB?**

*This command returns the data in CCDF table: average input power, probability at the average input power, power level at various predefined probability steps (10 %, 1 %, 0.1 %, 0.01 %, 0.001 % and 0.0001 %), peak to average power ratio and sample count for Channel B.*

**NOTE**

The sample count will always be returned as 100 million samples (100,000,000).

## Error Messages

- If no power sensor is connected, error -241 "Hardware missing" occurs.
- If sensor/sensors connected are not P-Series sensors, error -241 "Hardware missing" occurs.
- If measurement speed setting is **FAST**, error -221 "Settings conflict" occurs.
- If the acquisition mode is in continuous triggering or triggering source is set to either **INT1**, **INT2**, or **EXT**, error -221 "Settings conflict" occurs.

THIS PAGE HAS BEEN INTENTIONALLY LEFT BLANK.

# 10 SENSE Subsystem

[SENSe] Subsystem	343
[SENSe[1]]SENSe2:AVERAge Commands	346
[SENSe[1]]SENSe2:AVERAge:COUNT <numeric_value>	347
[SENSe[1]]SENSe2:AVERAge:COUNT:AUTO <boolean>	350
[SENSe[1]]SENSe2:AVERAge:SDETect <boolean>	353
[SENSe[1]]SENSe2:AVERAge[:STATe] <boolean>	355
[SENSe[1]]SENSe2:AVERAge2 Commands	357
[SENSe[1]]SENSe2:AVERAge2:COUNT <numeric_value>	358
[SENSe[1]]SENSe2:AVERAge2[:STATe] <boolean>	360
[SENSe[1]]SENSe2:BANDwidth BWIDth:VIDeo <character_data>	362
[SENSe[1]]SENSe2:CORRection Commands	364
[SENSe[1]]SENSe2:CORRection:CFACTOR GAIN[1][:INPut] [:MAGNitude] <numeric_value>	365
[SENSe[1]]SENSe2:CORRection:CSET[1] CSET2 Commands	368
[SENSe[1]]SENSe2:CORRection:CSET[1] CSET2:SElect <string>	369
[SENSe[1]]SENSe2:CORRection:CSET[1] CSET2:STATe <boolean>	371
[SENSe[1]]SENSe2:CORRection:DCYCLE GAIN3 Commands	373
[SENSe[1]]SENSe2:CORRection:DCYCLE GAIN3[:INPut] [:MAGNitude] <numeric_value>	374
[SENSe[1]]SENSe2:CORRection:DCYCLE GAIN3:STATe <boolean>	377
[SENSe[1]]SENSe2:CORRection:FDOFFset GAIN4[:INPut] [:MAGNitude]? <numeric_value>	379
[SENSe[1]]SENSe2:CORRection:GAIN2 Commands	380
[SENSe[1]]SENSe2:CORRection:GAIN2:STATe <boolean>	381
[SENSe[1]]SENSe2:CORRection:GAIN2[:INPut] [:MAGNitude] <numeric_value>	383
[SENSe[1]]SENSe2:FREQuency[:CW :FIXed] <numeric_value>	386
[SENSe[1]]SENSe2:MRATe <character_data>	388
[SENSe[1]]SENSe2:POWER:AC:RANGe <numeric_value>	391

[SENSe[1]]SENSe2:POWer:AC:RANGe:AUTO <boolean>	393
[SENSe[1]]SENSe2:SWEEp[1]2 3 4 Commands	395
[SENSe[1]]SENSe2:SWEEp[1]2 3 4:OFFSet:TIME <numeric_value>	396
[SENSe[1]]SENSe2:SWEEp[1]2 3 4:TIME <numeric_value>	398
[SENSe[1]]SENSe2:TEMPerature?	400
[SENSe[1]]SENSe2:TRACe Commands	401
[SENSe[1]]SENSe2:TRACe:OFFSet:TIME <numeric_value>	402
[SENSe[1]]SENSe2:TRACe:TIME <numeric_value>	404
[SENSe[1]]SENSe2:TRACe:UNIT <character_data>	406
[SENSe[1]]SENSe2:V2P ATYPe DTYPe	408
SENSe[1]2:TRACe:LIMit:LOWer <numeric_value>	410
SENSe[1]2:TRACe:LIMit:UPPer <numeric_value>	412
SENSe[1]2:TRACe:X:SCALE:PDIV <numeric_value>	414
SENSe[1]2:TRACe:Y:SCALE:PDIV <numeric_value>	416

This chapter explains how the **SENSe** command subsystem directly affects device specific settings used to make measurements.

## [SENSe] Subsystem

The **SENSe** command subsystem directly affects device specific settings used to make measurements. The **SENSe** subsystem is optional since this is the primary function of the power meter. The high level command **CONFigure** uses the **SENSe** commands to prepare the power meter for making measurements. At a lower level **SENSe** enables you to change the following parameters: **RANGe**, **FREQuency**, **LOSS**, **CFACtor|GAIN1** (calibration factor), **GAIN2** (channel offset), **DCYCLe** (duty cycle) and **AVERAge**, without completely re-configuring the power meter.

The **SENSe** command subsystem also allows you to select the measurement speed, a sensor calibration table, and a frequency dependent offset table.

The numeric suffix of the **SENSe** program mnemonic in the **SENSe** commands refers to a channel, that is **SENSe1** and **SENSe2** represent Channel A and Channel B respectively.

Keyword	Parameter Form	Notes	Page
<b>[SENSe[1]] SENSe2</b>			
<b>:AVERAge</b>			
<b>:COUNT</b>	<numeric_value>		page 347
<b>:AUTO</b>	<boolean>		page 350
<b>:SDEtect</b>	<boolean>	[non-SCPI]	page 353
<b>[:STATe]</b>	<boolean>		page 355
<b>:AVERAge2</b>			
<b>:COUNT</b>	<numeric_value>		page 358
<b>[:STATe]</b>	<boolean>		page 360
<b>:BANDwidth BWIDth</b>			
<b>:VIDeo</b>	<character_data>		page 362
<b>:CORRection</b>			
<b>:CFACtor GAIN[1]</b>		[non-SCPI]	
<b>[:INPut]</b>			
<b>[:MAGNitude]</b>	<numeric_value>		page 365

Keyword	Parameter Form	Notes	Page
:CSET[1] CSET2			
[:SElect]	<string>		page 369
:STATe	<boolean>		page 371
:DCYCLe GAIN3		[non-SCPI]	
[:INPut]			
[:MAGNitude]	<numeric_value>		page 374
:STATe	<boolean>		page 377
:FDOFFset GAIN4			
[:INPut]			
[:MAGNitude]		[query only]	page 379
:GAIN2			
:STATe	<boolean>		page 381
[:INPut]			
[:MAGNitude]	<numeric_value>		page 383
:FREQuency			
[:CW]:FIXed]	<numeric_value>		page 386
:MRATe	<character_data>		page 388
:POWer			
:AC			
:RANGe	<numeric_value>	[non-SCPI]	page 391
:AUTO	<boolean>		page 393
:SWEp[1] 2 3 4			
:OFFSet			
:TIME	<numeric_value>		page 396
:TIME	<numeric_value>		page 398
:TEMPerature?		[query only]	page 400
:TRACe			



Keyword	Parameter Form	Notes	Page
:OFFSet			
:TIME	<numeric_value>		page 402
:TIME	<numeric_value>		page 404
:UNIT	<character_data>		page 406
:V2P	ATYPe DTYPe	[non-SCPI]	page 408
SENSe[1] 2			
:TRACe			
:LIMit			
:LOWer	<numeric_value>		page 410
:UPPer	<numeric_value>		page 412
:X			
:SCALe			
:PDIV	<numeric_value>		page 414
:Y			
:SCALe			
:PDIV	<numeric_value>		page 416

## [SENSe[1]]|SENSe2:AVERAge Commands

These commands control the measurement averaging which is used to improve measurement accuracy. They combine successive measurements to produce a new composite result.

The following commands are detailed in this section:

```
[SENSe[1]]|SENSe2:AVERAge:COUNT <numeric_value>  
[SENSe[1]]|SENSe2:AVERAge:COUNT:AUTO <boolean>  
[SENSe[1]]|SENSe2:AVERAge:SDETECT <boolean>  
[SENSe[1]]|SENSe2:AVERAge[:STATe] <boolean>
```

[SENSe[1]]|SENSe2:AVERage:COUNT <numeric\_value>

This command is used to enter a value for the filter length. If

[SENSe[1]]|SENSe2:AVERage:COUNT:AUTO is set to **ON** then entering a value for the filter length automatically sets it to **OFF**. Increasing the value of filter length increases measurement accuracy but also increases the time taken to make a power measurement.

Entering a value using this command automatically turns the [SENSe[1]]|SENSe2:AVERage:STATe command to **ON**.

**NOTE**

For most applications, automatic filter length selection ([SENSe[1]]|SENSe2:AVERage:COUNT:AUTO ON) is the best mode of operation. However, manual filter length selection ([SENSe[1]]|SENSe2:AVERage:COUNT <numeric\_value>) is useful in applications requiring either high resolution or fast settling times, where signal variations rather than measurement noise need filtering, or when approximate results are needed quickly.

---

### Syntax

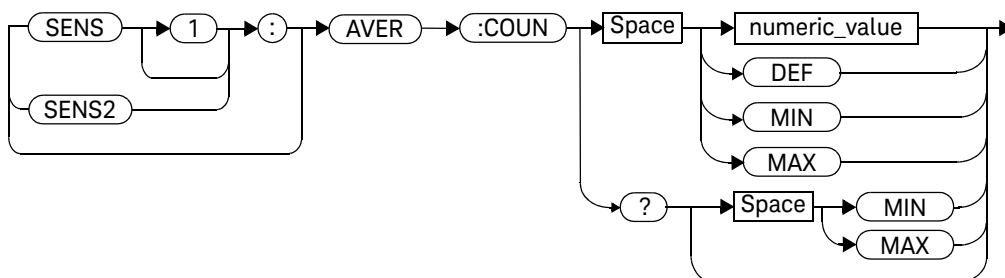

### Parameters

Item	Description/Default	Range of Values
numeric_value	A numeric value defining the filter length. DEF: the default value is 4 MIN: 1 MAX: 1024	1 to 1024 DEF MIN MAX

### Example

**AVER:COUN 400**

*This command enters a filter length of 400 for Channel A.*

### Reset Condition

On reset, the filter length is set to 4.

## Query

**AVERage:COUNT?** [MIN|MAX]

The query returns the current setting of the filter length or the values associated with **MIN** and **MAX**. The format of the response is **<NR1>**.

## Query Example

**AVER:COUNT?**

*This command queries the filter length for Channel A.*

## Error Messages

If a filter length value is entered using **[SENSe[1]]|SENSe2:AVERage:COUNT** while **[SENSe[1]]|SENSe2:SPEed** is set to 200, the error -221, "Settings Conflict" occurs. However, the filter length value is set but the **[SENSe[1]]|SENSe2:AVERage:STATe** command is not automatically set **ON**.

## [SENSE[1]]|SENSE2:AVERAGE:COUNT:AUTO <boolean>

This command enables and disables automatic averaging. **ONCE** has no effect on the power meter.

When the auto filter mode is enabled, the power meter automatically sets the number of readings averaged together to satisfy the averaging requirements for most power measurements. The number of readings averaged together depends on the resolution and the power level in which the power meter is currently operating. **Figure 10-1** is an example of the averaged number of readings for each range and resolution when the power meter is in auto measurement average mode and using a P-Series power sensor.

Setting this command to **ON** automatically sets the [SENSE[1]]|SENSE2:AVERAGE:STATE command to **ON**.

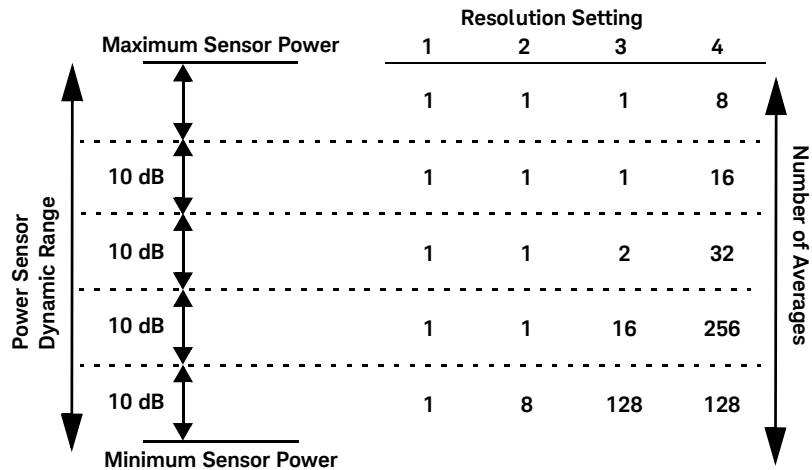

**Figure 10-1** Example of averaged readings

If [SENSE[1]]|SENSE2:AVERAGE:COUNT:AUTO is set to **OFF**, the filter length is set by the [SENSE[1]]|SENSE2:AVERAGE:COUNT command. Using the [SENSE[1]]|SENSE2:AVERAGE:COUNT command disables automatic averaging.

Auto averaging is enabled by the MEASURE:POWER:AC? and CONFIGURE:POWER:AC? commands.

**NOTE**

For most applications, automatic filter length selection ([SENSe[1]]|SENSe2:AVERage:COUNT:AUTO ON) is the best mode of operation. However, manual filter length selection ([SENSe[1]]|SENSe2:AVERage:COUNT <numeric\_value>) is useful in applications requiring either high resolution or fast settling times, where signal variations rather than measurement noise need filtering, or when approximate results are needed quickly.

## Syntax

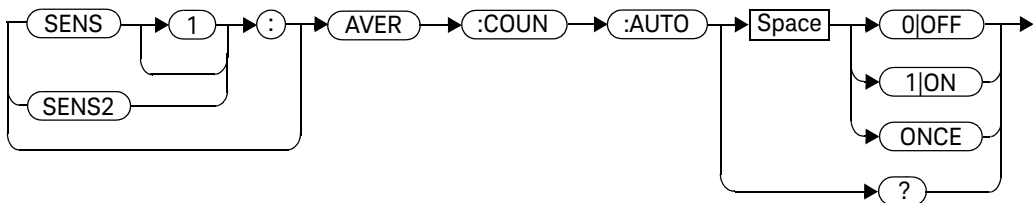

## Example

```
AVER:COUNT:AUTO OFF
```

*This command disables automatic filter length selection for Channel A.*

## Reset Condition

On reset, automatic averaging is enabled.

## Query

```
[SENSe[1]]|SENSe2:AVERage:COUNT:AUTO?
```

The query enters a 1 or 0 into the output buffer indicating whether automatic filter length is enabled or disabled.

- 1 is returned when automatic filter length is enabled
- 0 is returned when automatic filter length is disabled

## Query Example

**AVER:COUN:AUTO?**

*This command queries whether automatic filter length selection is on or off for Channel A.*

## Error Messages

If **[SENSe[1]]|SENSe2:AVERage:COUNT:AUTO** is set to **ON** while **[SENSe[1]]|SENSe2:SPEEd** is set to 200, the error -221, "Settings Conflict" occurs. However, automatic averaging is enabled but the **[SENSe[1]]|SENSe2:AVERage:STATE** command is not automatically set **ON**.



## [SENSe[1]]|SENSe2:AVERage:SDETECT <boolean>

This command enables and disables step detection. In **AUTO** filter mode, the average of the last four values entered into the filter is compared to the average of the entire filter. If the difference between the two averages is greater than 12.5%, the digital filter is cleared. The filter then starts storing new measurement values. This feature shortens the filter time when the input power changes substantially. for the filter output to get to its final value. Note that this result appears to settle faster, although true settling to the final value is unaffected.

### NOTE

Step detection is automatically disabled when TRIG:DEL:AUTO is ON and the trigger mode is set to free run.

Under this circumstances the value of SENS:AVER:SDET is ignored. Note also that SENS:AVER:SDET is not set by the instrument (that is, SENS:AVER:SDET retains its current setting which may indicate that step detection is ON).

---

### NOTE

With certain pulsing signals step detect may operate on the pulses, preventing the final average being completed and making the results unstable. Under these conditions SDET should be set to OFF.

---

## Syntax

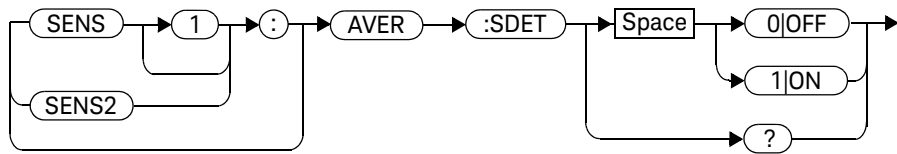

## Example

```
SENS: AVER: SDET OFF
```

*This command disables step detection.*

## Reset Condition

On reset, step detection is enabled.

## Query

```
[SENSe[1]]|SENSe2: AVERage: SDETECT?
```

The query enters a 1 or 0 into the output buffer indicating the status of step detection.

- 1 is returned when step detection is enabled
- 0 is returned when step detection is disabled

## Query Example

```
SENS: AVER: SDET?
```

*This command queries whether step detection is on or off.*

[SENSe[1]]|SENSe2:AVERage[:STATe] <boolean>

This command is used to enable and disable averaging.

### Syntax

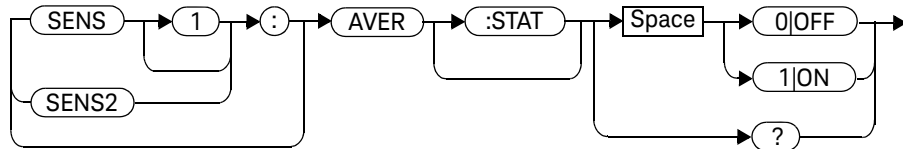

### Example

**AVER 1**

*This command enables averaging on Channel A.*

### Reset Condition

On reset, averaging is **OFF**.

### Query

[SENSe[1]]|SENSe2:AVERage[:STATe]?

The query enters a 1 or 0 into the output buffer indicating the status of averaging.

- 1 is returned when averaging is enabled
- 0 is returned when averaging is disabled

## Query Example

**SENS2:AVER?**

*This command queries whether averaging is on or off for Channel B.*

## Error Messages

If **[SENSe[1]]|SENSe2:AVERage:STATE** is set to **ON** while **[SENSe[1]]|SENSe2:SPEed** is set to 200, the error -221, "Settings Conflict" occurs.

## [SENSe[1]]|SENSe2:AVERage2 Commands

These commands control video averaging, which is used to improve measurement accuracy, for the P-Series power sensor. They combine successive measurements to produce a new composite result.

**NOTE**

If the command is used when a sensor other than a P-Series power sensor is connected, error -241, “Hardware missing” occurs.

---

The following commands are detailed in this section:

```
[SENSe[1]]|SENSe2:AVERage2:COUNT <numeric_value>  
[SENSe[1]]|SENSe2:AVERage2[:STATe] <boolean>
```

## [SENSe[1]]|SENSe2:AVERage2:COUNT <numeric\_value>

This command is used to enter the video filter length for the P-Series sensor. Video filtering is applied to the traces. Successive traces are combined to reduce noise without affecting the dynamic characteristic of the signal.

### Syntax

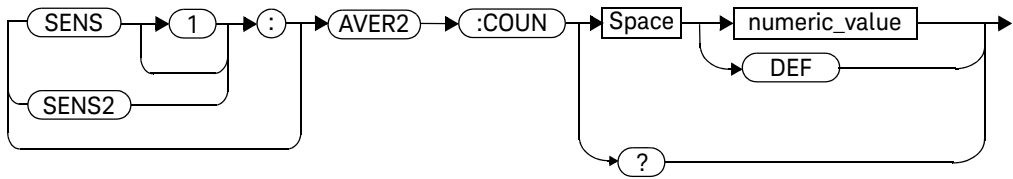

### Parameters

Item	Description/Default	Range of Values
numeric_value	A numeric value defining the filter length. – DEF: the default value is 4.	1 to 256 <sup>[a]</sup> DEF

[a] This is only implemented in powers of 2 (2<sup>n</sup>).

### Example

**AVER2:COUNT 16**

*This command enters a video filter length of 16 for Channel A.*

### Reset Condition

On reset, the filter length is set to 4.

## Query

### **AVERage2:COUNT?**

The query returns the current setting of the video filter length. The format of the response is **<NR1>**.

## Query Example

### **AVER2:COUNT?**

*This command queries the video filter length for Channel A.*

## Error Messages

- If the command is used when a sensor other than a P-Series power sensor is connected, error -241, "Hardware missing" occurs

## [SENSe[1]]|SENSe2:AVERage2[:STATe] <boolean>

This command is used to enable and disable video averaging for the P-Series sensor.

### Syntax

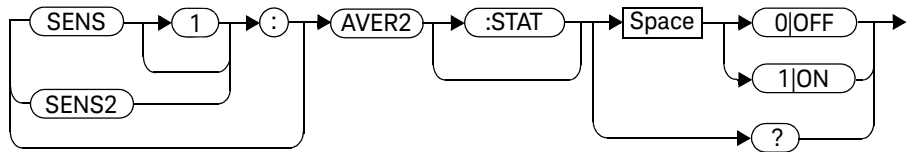

### Example

**AVER2 1**

*This command enables video averaging on Channel A.*

### Reset Condition

On reset, averaging is enabled.

### Query

**[SENSe[1]]|SENSe2:AVERage2[:STATe]?**

The query enters a 1 or 0 into the output buffer indicating the status of averaging.

- 1 is returned when averaging is enabled.
- 0 is returned when averaging is disabled.



## Query Example

**SENS2:AVER2?**

*This command queries whether averaging is on or off for Channel B.*

## Error Messages

- If the command is used when a sensor other than a P-Series power sensor is connected, error -241, “Hardware missing” occurs

[SENSe[1]]|SENSe2:BANDwidth|BWIDth:VIDeo <character\_data>

This command sets the sensor bandwidth on a P-Series sensor.

### Syntax

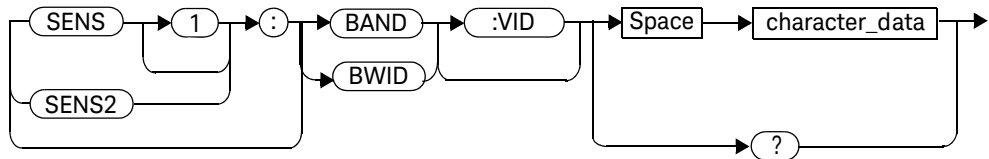

### Parameters

Item	Description/Default	Range of Values
character_data	Defines the sensor bandwidth.	HIGH MEDium LOW OFF

### Example

**SENSe1:BAND:VID HIGH**

*This command sets sensor bandwidth to high for Channel A.*

### Reset Condition

On reset, sensor bandwidth is set to **OFF**.

## Query

`[SENSe[1]]|SENSe2:BANDwidth|BWIDth:VIDeo?`

The query returns the current sensor bandwidth setting.

## Query Example

`SENSe2:BAND:VID?`

*This command queries the current sensor bandwidth setting for Channel B.*

## Error Messages

- If the command is used when a sensor other than a P-Series power sensor is connected, error -241, "Hardware missing" occurs
- If the command is used when a P-Series sensor is connected and set to **AVERage** mode rather than **NORMal** mode, the error -221, "Settings Conflict" occurs.

### NOTE

Selection of video bandwidth to **LOW**, **MED** or **HIGH** implements digital signal processing to ensure a flat bandwidth up to the frequency shown, bandwidths are flat to  $\pm 0.1$  dB. In the **OFF** state no corrections are applied and the response has a slow roll-off.

---

## [SENSe[1]]|SENSe2:CORRection Commands

These commands provide for changes to be applied to the measurement result. They are used to enter duty cycle values, calibration factors and other external gains and losses.

The following commands are detailed in this section:

```
[SENSe[1]]|SENSe2:CORRection:CFACTOR|GAIN[1][:INPut]
[:MAGNitude] <numeric_value>
[SENSe[1]]|SENSe2:CORRection:CSET[1]|CSET2
[:SElect] <string>
[SENSe[1]]|SENSe2:CORRection:CSET[1]|CSET2:STATE <boolean>
[SENSe[1]]|SENSe2:CORRection:DCYCLE|GAIN3[:INPut]
[:MAGNitude] <numeric_value>
[SENSe[1]]|SENSe2:CORRection:DCYCLE|GAIN3:STATE <boolean>
[SENSe[1]]|SENSe2:CORRection:FDOFFset|GAIN4[:INPut]
[:MAGNitude]?
[SENSe[1]]|SENSe2:CORRection:LOSS2[:INPut][:MAGNitude]
<numeric_value>
[SENSe[1]]|SENSe2:CORRection:LOSS2:STATE <boolean>
```

```
[SENSe[1]]|SENSe2:CORRection:CFACtor|GAIN[1][[:INPut]
[:MAGNitude] <numeric_value>
```

This command is used to enter a gain correction value for the calibration factor. The power meter corrects every measurement by this factor to compensate for the gain.

Either **CFACtor** and **GAIN1** can be used in the command—both have an identical result. Using **GAIN1** complies with the SCPI standard, whereas **CFACtor** does not—this may make your program easier to understand.

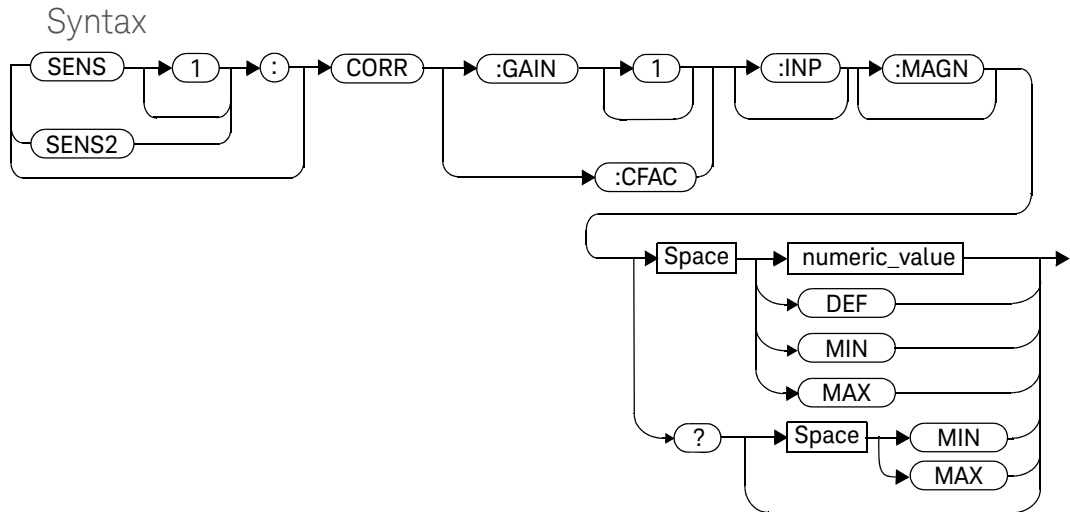

## Parameters

Item	Description/Default	Range of Values
numeric_value (for <b>CFACTOR</b> and <b>GAIN1</b> )	A numeric value. – <b>DEF</b> : the default value is 100 % – <b>MIN</b> : 1 % – <b>MAX</b> : 150 %	1 to 150 PCT <sup>[a]</sup> <b>DEF</b> <b>MIN</b> <b>MAX</b>

[a] For example, a gain of 60 % corresponds to a multiplier of 0.6 and a gain of 150 % corresponds to a multiplier of 1.5.

### Example

**SENSE2:CORR:GAIN1**

*This command sets a gain correction of 100% for Channel B.*

### Reset Condition

On reset, **CFACTOR|GAIN1** is set to 100 %.

### Query

**[SENSE[1]]|SENSE2:CORREction:CFACTOR|GAIN[1][[:INPUT]  
[:MAGNitude]? [MIN|MAX]**

The query returns the current gain correction setting or the values associated with **MIN** and **MAX**.

## Query Example

**CORR:GAIN1?**

*This command queries the current calibration factor setting for Channel A.*

## Error Messages

The **SENSe[1]]|SENSe2:CORRection:CFACTOR|GAIN1** command can be used for the 8480 Series Power Sensor when no sensor calibration table has been set up. If a sensor calibration table is selected the error -221, “Settings Conflict” occurs.

## [SENSe[1]]|SENSe2:CORRection:CSET[1]|CSET2 Commands

These commands are used to select the active sensor calibration table (using CSET1) and the active frequency dependent offset table (using CSET2).

**NOTE**

If any of the CSET1 commands are used when a P-Series or E-Series power sensor is connected, the error -241, “Hardware missing” occurs.

---

The following commands are detailed in this section:

```
[SENSe[1]]|SENSe2:CORRection:CSET[1]|CSET2[:SElect] <string>  
[SENSe[1]]|SENSe2:CORRection:CSET[1]|CSET2:STATe <boolean>
```



[SENSe[1]]|SENSe2:CORRection:CSET[1]|CSET2[:SElect] <string>

This command enters the name of the sensor calibration table or frequency dependent offset table which is to be used. The **CSET1** command selects the sensor calibration table and the **CSET2** command selects the frequency dependent offset table. The calibration factor is interpolated from the table using the setting for [SENSe[1]]|SENSe2:FREQUENCY.

#### NOTE

If [SENSe[1]]|SENSe2:CORRection:CSET[1]|CSET2:STAtE is set to OFF, the selected sensor calibration table or frequency offset table is not being used.

#### Syntax

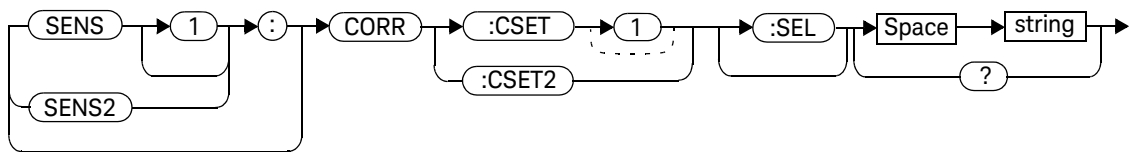

#### Parameters

Item	Description/Default	Range of Values
string	String data representing a sensor calibration table, or frequency dependent offset table name.	Any existing table name (Existing table names can be listed using <b>MEMory:CATalog:TABLE?</b> ).

## Example

**CORR:CSET1 'PW1'**

*This command enters the name of the sensor calibration table which is to be used on Channel A.*

## Reset Condition

On reset the selected table is not affected.

## Query

**[SENSe[1]]|SENSe2:CORRection:CSET[1]|CSET2:[SElect]?**

The name of the selected table is returned as a quoted string. If no table is selected an empty string is returned.

## Query Example

**CORR:CSET1?**

*This command queries the sensor calibration table currently used for Channel A.*

## Error Messages

- If **<string>** is not valid, error -224, "Illegal parameter value" occurs.
- If a table called **<string>** does not exist, error -256, "File name not found" occurs.
- When a sensor calibration table is selected, the power meter verifies that the number of calibration points defined is one more than the number of frequency points defined. When a frequency dependent offset table is selected, the power meter verifies that the number of offset points defined is equal to the number of frequency points defined. If this is not the case, error -226, "Lists not the same length" occurs.
- If the **CSET1** command is used when a P-Series or an E-Series Power Sensor is connected the error -241, "Hardware missing" occurs.

[SENSe[1]]|SENSe2:CORRection:CSET[1]|CSET2:STATe <boolean>

This command is to enable and disable the use of the currently active sensor calibration table (**CSET1**) or frequency dependent offset table (**CSET2**). When a table has been selected and enabled, the calibration factors/offsets stored in it can be used by specifying the required frequency using the [SENSe[1]]|SENSe2:FREQuency command.

When the **CSET1** command is set to **ON**, the reference calibration factor is taken from the sensor calibration table and is used during calibration.

### Syntax

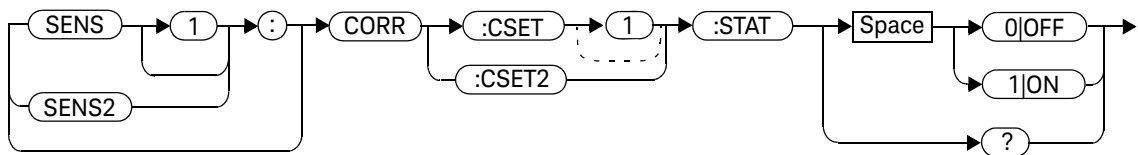

### Example

**CORR:CSET1:STAT 1**

*This command enables the use of the currently active sensor calibration table for Channel A.*

### Reset Condition

On reset, the sensor calibration table and frequency dependent offset table are not affected.

## Query

**[SENSe[1]]|SENSe2:CORRection:CSET[1]|CSET2:STATe?**

The query returns a 1 or 0 into the output buffer indicating whether a table is enabled or disabled.

- 1 is returned when the table is enabled
- 0 is returned when the table is disabled

## Query Example

**SENS2:CORR:CSET1:STAT?**

*This command queries whether there is currently an active sensor calibration table for Channel B.*

## Error Messages

If you attempt to set this command to **ON** and no table has been selected using **[SENSe[1]]|SENSe2:CORRection:CSET[1]|CSET2:[SElect]** then error -221, "Settings conflict" occurs and **[SENSe[1]]|SENSe2:CORRection:CSET[1]|CSET2:STATe** remains **OFF**.

## [SENSe[1]]|SENSe2:CORRection:DCYCLe|GAIN3 Commands

These commands control the pulse power measurement feature of the power meter.

The following commands are detailed in this section:

```
[SENSe[1]]|SENSe2:CORRection:DCYCLe|GAIN3[:INPut]
[:MAGNitude] <numeric_value>
[SENSe[1]]|SENSe2:CORRection:DCYCLe|GAIN3:STATe <boolean>
```

### NOTE

You can use either DCYCLe or GAIN3 in these commands, both do the same. Using GAIN3 complies with the SCPI standard whereas DCYCLe does not, but may make your program more understandable.

---

```
[SENSe[1]]|SENSe2:CORRection:DCYCLe|GAIN3[:INPut]
[:MAGNitude] <numeric_value>
```

This command is used to set the duty cycle for the pulse power measurement feature of the power meter. Pulse power measurements average out any deviations in the pulse, such as, overshoot or ringing. The result returned for a pulse power measurement is a mathematical representation of the pulse power rather than an actual measurement. The power meter measures the average power in the pulsed input signal and then divides the result by the duty cycle value to obtain a pulse power reading.

Entering a value using this command automatically turns the [SENSe[1]]|SENSe2:CORRection:DCYCLe|GAIN3:STAtE command to ON.

#### NOTE

Pulse measurements are not recommended using E-Series power sensors at power levels above -20 dBm.

Pulse power averages out any deviations in the pulse such as overshoot or ringing. Hence, it is called pulse power and not peak power or peak pulse power.

In order to ensure accurate pulse power readings, the input signal must be pulsed with a rectangular pulse. Other pulse shapes (such as triangle, chirp or Gaussian) cause incorrect results.

The pulse power on/off ratio must be much greater than the duty cycle ratio.

---

### Syntax

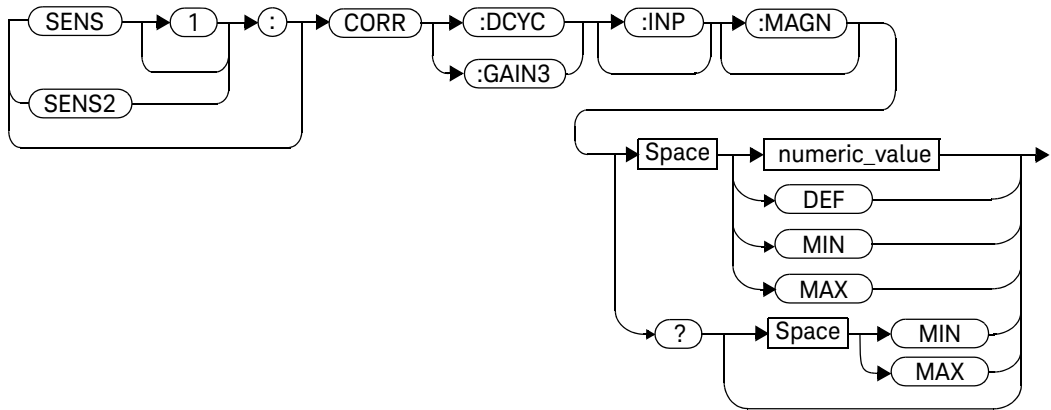

### Parameters

Item	Description/Default	Range of Values
numeric_value	A numeric value for the duty cycle. – <b>DEF</b> : the default value is 1 % – <b>MIN</b> : 0.001 % – <b>MAX</b> : 99.999 % The units are PCT, and are optional.	0.001 to 99.999 PCT <b>DEF</b> <b>MIN</b> <b>MAX</b>

### Example

**CORR:DCYC 90PCT**

*This command sets a duty cycle of 90 % for Channel A.*

## Reset Condition

On reset, the duty cycle is set to 1 % (DEF).

## Query

```
[SENSe[1]]|SENSe2:CORRection:DCYClE|GAIN3[:INPut][:MAGNitude]?  
[MIN|MAX]
```

The query returns the current setting of the duty cycle or the values associated with **MIN** and **MAX**.

## Query Example

```
CORR:GAIN3?
```

*This command queries the current setting of the duty cycle for Channel A.*

## Error Messages

- If a duty cycle value is entered using `[SENSe[1]]|SENSe2:CORRection:DCYClE|GAIN3` while `[SENSe[1]]|SENSe2:SPEEd` is set to 200, the error -221, "Settings Conflict" occurs. However, the duty cycle value is set but the `[SENSe[1]]|SENSe2:CORRection:DCYClE|GAIN3:STATe` command is not automatically set **ON**.
- If this command is used when an P-Series or E-Series Power Sensor is connected, the error -310, "System error;Dty Cyc may impair accuracy with ECP sensor" occurs. If you are using a dual channel power meter the error message specifies the channel.



[SENSe[1]]|SENSe2:CORRection:DCYClE|GAIN3:STATe <boolean>

This command is used to enable and disable the pulse power measurement feature.

The [SENSe[1]]|SENSe2:CORRection:DCYClE|GAIN3 command should be used to enter the duty cycle of the signal you want to measure.

### Syntax

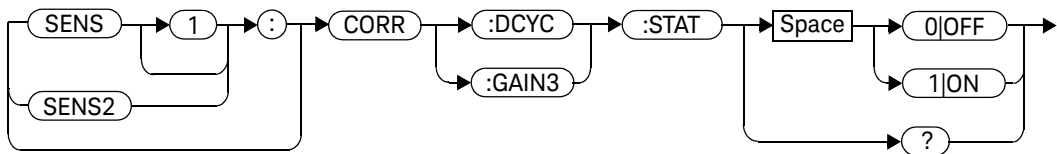

### Example

**CORR:DCYC:STAT 1**

*This command enables the pulse measurement feature on Channel A.*

### Reset Condition

On reset, the pulse power measurement feature is disabled.

### Query

**[SENSe[1]]|SENSe2:CORRection:DCYClE|GAIN3:STATe?**

The query enters a 1 or 0 into the output buffer indicating the status of the pulse power measurement feature.

- 1 is returned when the pulse power measurement feature is enabled
- 0 is returned when the pulse power measurement feature is disabled

## Query Example

**CORR:GAIN3:STAT?**

*This command queries whether the pulse measurement feature is on or off.*

## Error Messages

- If [SENSE[1]]|SENSE2:CORREction:DCYCLE:STATus is set to **ON** while [SENSE[1]]|SENSE2:SPEEd is set to 200, the error -221, "Settings Conflict" occurs.
- If this command is used when an P-Series or E-Series Power Sensor is connected, the error -310, "System error;Dty Cyc may impair accuracy with ECP sensor" occurs. If you are using a dual channel power meter the error message specifies the channel.

```
[SENSe[1]]|SENSe2:CORRection:FDOFfset[GAIN4[:INPut]
[:MAGNitude]?
```

This command is used to return the frequency dependent offset currently being applied.

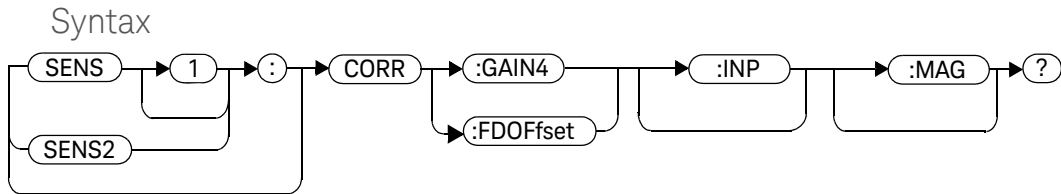

## Example

**CORR:GAIN4?**

*This command queries the current frequency dependent offset being applied to Channel A.*

## Reset Condition

On reset, the frequency dependent offset is not affected.

## [SENSe[1]]|SENSe2:CORRection:GAIN2 Commands

These commands provide a simple correction to a measurement for an external gain/loss.

The following commands are detailed in this section:

```
[SENSe[1]]|SENSe2:CORRection:GAIN2:STATe <boolean>
```

```
[SENSe[1]]|SENSe2:CORRection:GAIN2[:INPut][:MAGNitude]  
<numeric_value>
```

## [SENSe[1]]|SENSe2:CORRection:GAIN2:STATe <boolean>

This command is used to enable/disable a channel offset for the power meter setup. The [SENSe[1]]|SENSe2:CORRection:GAIN2[:INPut][:MAGNitude] command is used to enter the loss/gain value.

### Syntax

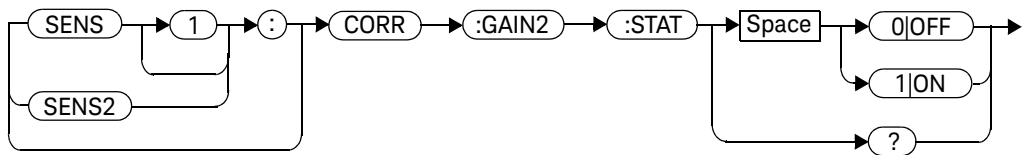

### Example

**CORR:GAIN2:STAT ON**

*This command enables a channel offset on Channel A.*

### Reset Condition

On reset, channel offsets are disabled.

### Query

**[SENSe[1]]|SENSe2:CORRection:GAIN2:STATe?**

The query enters 1 or 0 into the output buffer indicating the status of the channel offsets.

- 1 is returned if a channel offset is enabled
- 0 is returned if a channel offset is disabled

## Query Example

**CORR:GAIN2:STAT?**

*This command queries whether or not there is a channel offset applied to Channel A.*

## Error Messages

If **[SENSe[1]]|SENSe2:CORRection:GAIN2:STATe** is set to **ON** while **[SENSe[1]]|SENSe2:SPEEd** is set to 200, the error -221, "Settings Conflict" occurs.

[SENSe[1]]|SENSe2:CORRection:GAIN2[:INPut][:MAGNitude]  
<numeric\_value>

This command is used to enter a channel offset value for the power meter setup, for example cable loss. The power meter then corrects every measurement by this factor to compensate for the gain/loss.

Entering a value for **GAIN2** using this command automatically turns the [SENSe[1]]|SENSe2:CORRection:GAIN2:STaTe command to **ON**.

### Syntax

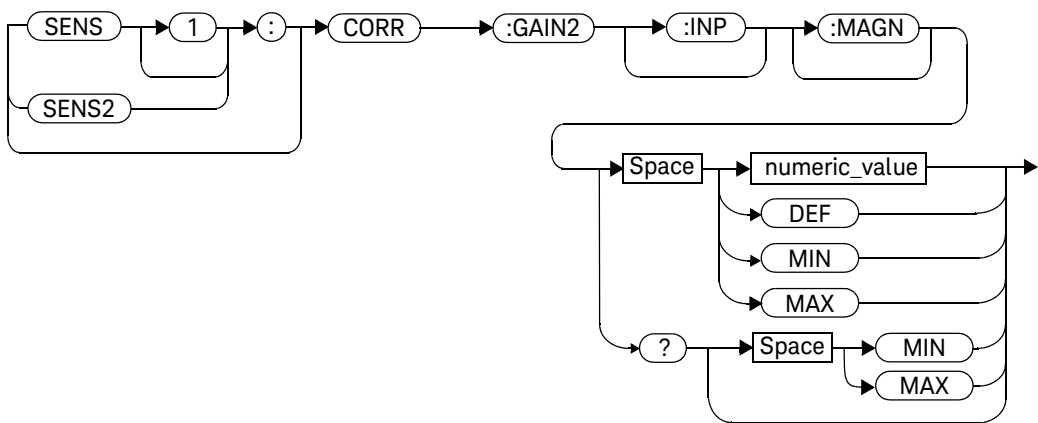

## Parameters

Item	Description/Default	Range of Values
numeric_value	A numeric value: - <b>DEF</b> : the default is 0.00 dB - <b>MIN</b> : -100 dB - <b>MAX</b> : +100 dB	-100 to +100 dB <b>DEF</b> <b>MIN</b> <b>MAX</b>

### Example

```
CORR:GAIN2 50
```

*This command sets a channel offset of 50 dB for Channel A.*

### Reset Condition

On reset, **GAIN2** is set to 0.00 dB.

### Query

```
[SENSe[1]]|SENSe2:CORRection:GAIN2[:INPut][:MAGNitude]? [MIN|MAX]
```

The query returns the current setting of the channel offset or the values associated with **MIN** and **MAX**.



## Query Example

**CORR:GAIN2?**

*This command queries the current setting of the channel offset on Channel A.*

## Error Messages

- If a loss/gain correction value is entered using **[SENSe[1]]|SENSe2:CORRection:GAIN2[:INPut][:MAGNitude]** while **[SENSe[1]]|SENSe2:SPEed** is set to 200, the error -221, "Settings Conflict" occurs. However, the correction value is set but the **[SENSe[1]]|SENSe2:CORRection:GAIN2:STATe** command is not automatically set **ON**.
- The **SENSe[1]]|SENSe2:CORRection:GAIN2[:INPut][:MAGNitude]** command can be used for the 8480 Series Power Sensor when no sensor calibration table has been set up.

[SENSe[1]]|SENSe2:FREQuency[:CW|:FIXed] <numeric\_value>

This command is used to enter a frequency. If the frequency does not correspond directly to a frequency in the sensor calibration table, the power meter calculates the calibration factor using linear interpolation. For 8480 Series Power Sensor the power meter uses linear interpolation to calculate the calibration factor for the frequency entered if [SENSe[1]]|SENSe2:CORRection:CSET:STATe is ON. For P-Series and E-Series Power Sensor, the appropriate corrections are applied for the frequency selected, dependant on the calibration data stored in the sensor's EEPROM.

Syntax

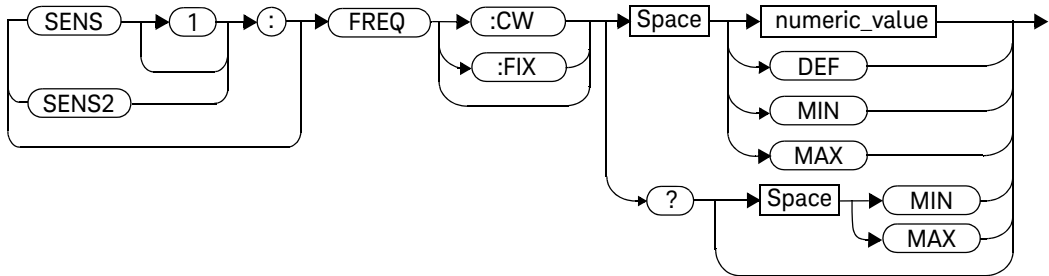

## Parameters

Item	Description/Default	Range of Values
numeric_value	A numeric value for the frequency: – <b>DEF</b> : the default value is 50 MHz – <b>MIN</b> : 1 kHz – <b>MAX</b> : 1000.0 GHz The default units are Hz.	1 kHz to 1000.0 GHz <sup>[a]</sup> <b>DEF</b> <b>MIN</b> <b>MAX</b>

- [a] The following measurement units can be used:
- Hz
  - kHz ( $10^3$ )
  - MHz ( $10^6$ )
  - GHz ( $10^9$ )

### Example

**FREQ 500kHz**

*This command enters a Channel A frequency of 500 kHz.*

### Reset Condition

On reset, the frequency is set to 50 MHz (**DEF**).

### Query

**[SENSe[1]] | SENSe2:FREQuency[:CW]:FIXed]? [MIN|MAX]**

The query returns the current frequency setting or the values associated with **MIN** and **MAX**. The units in which the results are returned are Hz.

### Query Example

**SENS2:FREQ?**

*This command queries the Channel B frequency setting.*

## [SENSe[1]]|SENSe2:MRATe &lt;character\_data&gt;

This command sets the measurement speed on the selected channel.

When a channel is set to **FAST**, the following couplings occur:

Command	Status
[SENSe[1]] SENSe2:AVERAge:STATe	OFF <sup>[a]</sup>
[SENSe[1]] SENSe2:CORRection:DCYClE:STATe	OFF <sup>[a]</sup>
[SENSe[1]] SENSe2:CORRection:GAIN2:STATe	OFF <sup>[a]</sup>
CALCulate[1 2 3 4]:GAIN:STATe	OFF <sup>[b]</sup>
CALCulate[1 2 3 4]:RELative:STATe	OFF <sup>[b]</sup>
CALCulate1 3:MATH:EXPRession	“(SENSe1)”
CALCulate2 4:MATH:EXPRession	“(SENSe2)”

[a] This change only occurs on the channel specified in the **SENSe:MRATe** command. When the specified channel is changed from **FAST** to **NORMa1** or **DOUB1e**, the settings that were in place when **FAST** was entered are restored.

[b] This change occurs when either channel is set to **FAST**. When both channels are changed from **FAST** to **NORMa1** or **DOUB1e**, the settings that were in place when **FAST** was entered are restored.

## Syntax

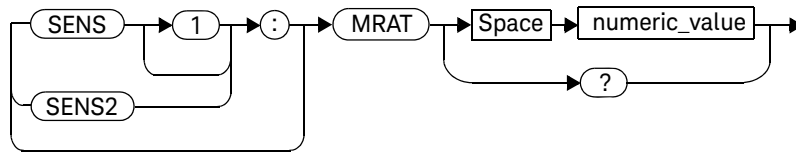

## Parameters

Item	Description/Default	Range of Values
character_data	A numeric value for the measurement speed: <ul style="list-style-type: none"> <li>- <b>NORMa1</b>: 20 readings/second</li> <li>- <b>DOUBLe</b>: 40 readings/second</li> <li>- <b>FAST</b>: up to 1000 readings/second</li> </ul> The default is <b>NORMa1</b> .	<b>NORMa1</b> <sup>[a]</sup> <b>DOUBLe</b> <sup>[a]</sup> <b>FAST</b>

[a] When a channel is set to **NORMa1** or **DOUBLe**, **TRIG:COUNT** is set automatically to 1.

## Example

```
MRAT DOUBLe
```

*This command sets the Channel A speed to 40 readings/second.*

## Reset Condition

On reset, the speed is set to **NORMa1**.

## Query

```
[SENSe[1]]|SENSe2:MRAT?
```

The query returns the current speed setting, either **NORMa1**, **DOUBLe** or **FAST**.

## Query Example

**MRAT?**

*This command queries the current speed setting for Channel A.*

## Error Messages

- If **<character\_data>** is not set to **NORMa1**, **DOUBle** or **FAST**, error -224 “Illegal parameter value” occurs.
- If a P-Series or an E-Series Power Sensor is not connected and **<character\_data>** is set to **FAST**, error -241 “Hardware missing” occurs.

## [SENSe[1]]|SENSe2:POWer:AC:RANGe <numeric\_value>

This command is only valid when used with an E-Series Power Sensor. Its purpose is to select one of two power ranges.

- If 0 is selected, the power sensor's lower range is selected
- If 1 is selected, the power sensor's upper range is selected

Setting a range with this command automatically switches [SENSe[1]]|SENSe2:POWer:AC:RANGe:AUTO to OFF.

### Syntax

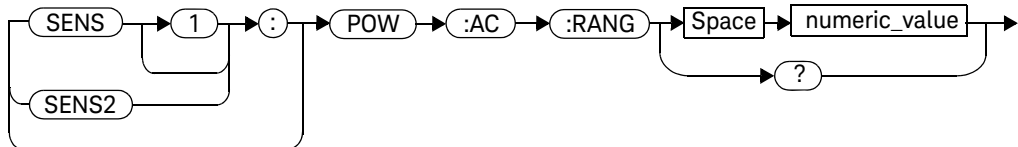

### Example

**POW:AC:RANG 0**

*This command sets the power sensor to its lower range.*

### Reset Condition

On reset, the upper range is selected.

### Query

**[SENSe[1]]|SENSe2:POWer:AC:RANGe?**

The query enters a 1 or 0 into the output buffer indicating the status of the power sensor's range.

- 1 is returned when the upper range is selected
- 0 is returned when the lower range is selected

## Query Example

**POW:AC:RANG?**

*This command queries the current setting of the power sensor range.*

## Error Messages

This command is used with the E-Series Power Sensor. If one is not connected the error -241, "Hardware missing" occurs.



## [SENSe[1]]|SENSe2:POWer:AC:RANGe:AUTO <boolean>

This command is only valid when used with an E-Series Power Sensor. Its purpose is to enable and disable autoranging. When autoranging is **ON**, the power meter selects the best measuring range for the measurement. When autoranging is set to **OFF**, the power meter remains in the currently set range.

The [SENSe[1]]|SENSe2:POWer:AC:RANGe command disables autoranging.

If **INITiate:CONTinuous** is set to **ON** and **TRIGger:SOURce** is set to **IMMediate**, the range tracks the input power if [SENSe[1]]|SENSe2:POWer:AC:RANGe:AUTO is **ON**.

If the power meter is not making measurements then autoranging only occurs when the power meter is triggered.

### Syntax

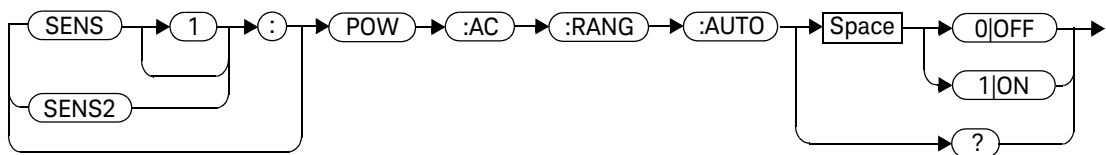

### Example

**POW:AC:RANG:AUTO 0**

*This command disables autoranging.*

### Reset Condition

On reset, autoranging is enabled.

## Query

**[SENSe[1]]|SENSe2:POWer:AC:RANGe:AUTO?**

The query enters a 1 or 0 into the output buffer indicating the status of autoranging.

- 1 is returned when autoranging is enabled
- 0 is returned when autoranging is disabled

## Query Example

**POW:AC:RANG:AUTO?**

*This command queries whether auto ranging is on or off.*

## Error Messages

- If this command is set to **OFF** when there is not an E-Series Power Sensor connected, the error -241, "Hardware missing" occurs.

## [SENSe[1]]|SENSe2:SWEEp[1]|2|3|4 Commands

These commands set offset time and time gate length as illustrated in the following diagram:

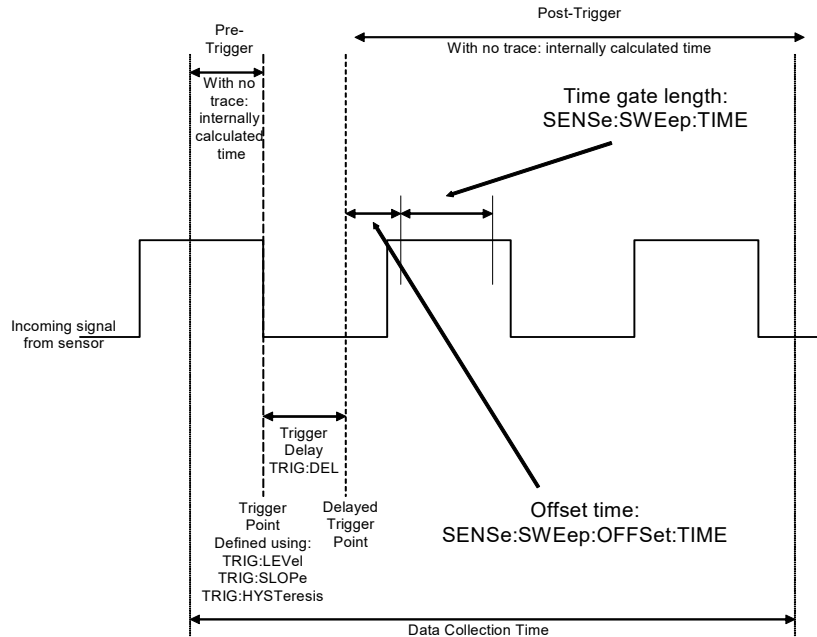

Offset time and time gate length values can be set for up to four measurement gates per channel. Measurement gate number is defined by the numeric value following the **SWEEp** component of the command.

### NOTE

These commands can only be used with P-Series sensors.

The following commands are detailed in this section:

```
[SENSe[1]]|SENSe2:SWEEp[1]|2|3|4:OFFSet:TIME <numeric_value>
[SENSe[1]]|SENSe2:SWEEp[1]|2|3|4:TIME <numeric_value>
```

[SENSe[1]]|SENSe2:SWEep[1]|2|3|4:OFFSet:TIME <numeric\_value>

This command sets the delay between the delayed trigger point and the start of the time-gated period (the offset time) for a P-Series sensor set to **NORMa1** mode. .

Syntax

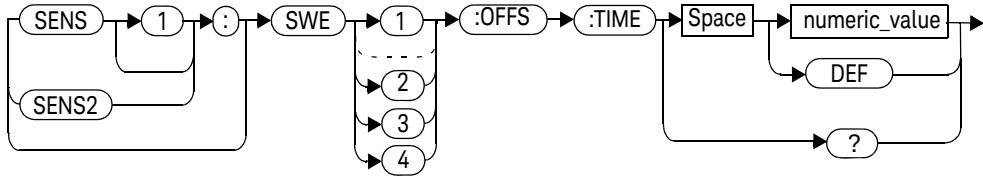

Parameters

Item	Description/Default	Range of Values
numeric_value	The delay between the trigger point and the start of the time-gated period. – <b>DEF</b> : the default value is 0 seconds Units are resolved to 1 ns.	–1 to 1 second <b>DEF</b>

## Example

**SENS2:SWE3:OFFS:TIME 0.001** *This command sets the delay to 0.001 seconds.*

## Reset Condition

On reset, the value is set to 0 seconds.

## Query

**SENSe[1]]|SENSe2:SWEp[1]|2|3|4:OFFSet:TIME?**

The query returns the current delay between the trigger point and the start of the time-gated period.

## Query Example

**SENS2:SWE2:OFFS:TIME?** *The query returns the current delay between the trigger point and the start of the time-gated period for Channel B and gate 2.*

## Error Messages

If the command is used when a sensor other than a P-Series power sensor is connected, error -241, "Hardware missing" occurs

## [SENSE[1]]|SENSE2:SWEep[1]|2|3|4:TIME <numeric\_value>

This command sets the length of the time-gated period (time-gate length) for time-gated measurements for the P-Series sensors which are set to **NORMa1** mode.

### Syntax

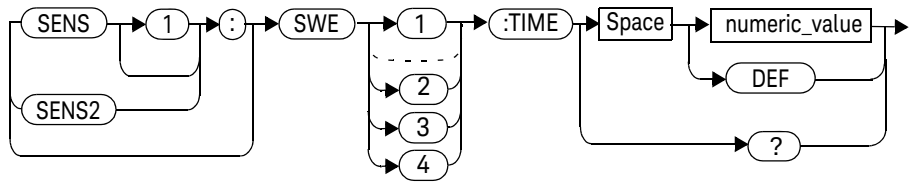

### Parameters

Item	Description/Default	Range of Values
numeric_value	The length of the time gated period in seconds. – <b>DEF</b> : the default value is 100 μs Units are resolved to 1 ns.	0 to 1 second <b>DEF</b>

### Example

**SENSE2:SWE3:TIME 0.001**

*This command sets the length to 0.001 seconds.*

## Reset Condition

On reset, gate 1 is set to 100  $\mu$ s and other gates to 0 s.

## Query

**SENSe[1]]|SENSe2:SWEp[1]|2|3|4:TIME?**

The query returns the current length of the time-gated period.

## Query Example

**SENS2:SWE2:TIME?**

*This command queries the length of the time-gated period for Channel B and gate 2.*

## Error Messages

- If the command is used when a sensor other than a P-Series power sensor is connected, error -241, "Hardware missing" occurs

## [SENSe[1]]|SENSe2:TEMPerature?

This this command to returns the P-Series power sensor's temperature in degrees Celsius.

## Syntax

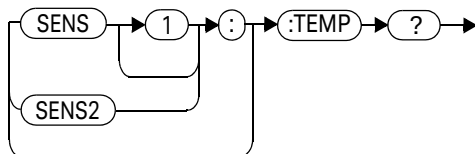

## Parameters

Item	Description/Default	Range of Values
numeric_value	A numeric value defining sensor's temperature in degrees Celsius.	-50 to 100

## Example

**SENS2:TEMP?**

*This command returns the current sensor temperature found on Channel B.*

## Reset Condition

On reset, this parameter is not affected.

## Error Messages

- If a P-Series sensor is not connected, error -241, "Hardware missing" occurs.



## [SENSe[1]]|SENSe2:TRACe Commands

These commands are used to set:

- The upper and lower limits for the trace display
- The delay between the delayed trigger point and the start of the trace
- The duration of the trace
- The trace units.

### NOTE

These commands can only be used with P-Series sensors.

The following commands are detailed in this section:

```
[SENSe[1]]|SENSe2:TRACe:LIMit:LOWer <numeric_value>
```

```
[SENSe[1]]|SENSe2:TRACe:LIMit:UPPer <numeric_value>
```

```
[SENSe[1]]|SENSe2:TRACe:OFFSet:TIME <numeric_value>
```

```
[SENSe[1]]|SENSe2:TRACe:TIME <numeric_value>
```

```
[SENSe[1]]|SENSe2:TRACe:UNIT <character_data>
```

```
[SENSe[1]]|SENSe2:V2P ATYPe|DTYPe
```

## [SENSE[1]]|SENSE2:TRACe:OFFSet:TIME <numeric\_value>

This command sets the delay between the delayed trigger point and the start of the trace for P-Series sensors are set to **NORMa1** mode.

### Syntax

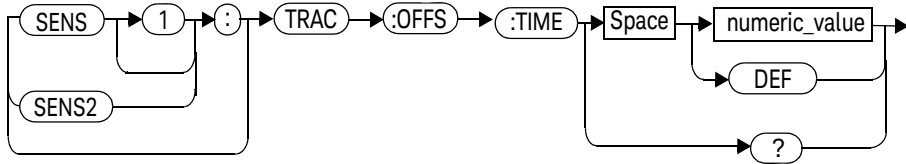

### Parameters

Item	Description/Default	Range of Values
numeric_value	The length of the delay in seconds. - DEF: the default value is 0 seconds Units are resolved to 1 ns.	-1 to 1 second DEF

### Example

**SENSE:TRAC:OFFS:TIME TIME 0.05** *This command sets the delay to 0.05 seconds.*

## Reset Condition

On reset, the delay is set to 0 seconds.

## Query

**SENSe[1]]|SENSe2:TRACe:OFFSet:TIME?**

The query returns the current delay between the delayed trigger point and the start of the trace.

## Query Example

**SENS:TRAC:OFFS:TIME?**

*This command queries the current delay between the delayed trigger point and the start of the trace for Channel A.*

## Error Messages

- If the command is used when a sensor other than a P-Series power sensor is connected, error -241, "Hardware missing" occurs

## [SENSE[1]]|SENSE2:TRACe:TIME <numeric\_value>

This command sets the duration of the trace for a P-Series sensor set to **NORMa1** mode.

### Syntax

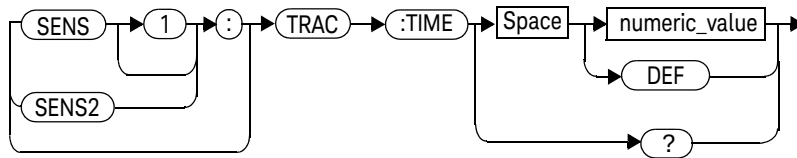

### Parameters

Item	Description/Default	Range of Values
numeric_value	The duration of the trace in seconds. – DEF: the default value is 100 $\mu$ s. Units are resolved to 1 ns.	10 $\mu$ s to 1 second DEF

### Example

**SENSE2:TRAC:TIME 0.5**

*This command sets the duration of the trace to 0.5 seconds for Channel B.*

## Reset Condition

On reset, the duration is set to 100  $\mu$ s.

## Query

**SENSe[1]]|SENSe2:TRACe:TIME?**

The query returns the current duration of the trace.

## Query Example

**SENSe2:TRACe:TIME?**

*This command queries the current duration of the trace.*

## Error Messages

- If the command is used when a sensor other than a P-Series power sensor is connected, error -241, "Hardware missing" occurs

[SENSe[1]]|SENSe2:TRACe:UNIT <character\_data>

This command sets the units for the trace for the specified channel.

### Syntax

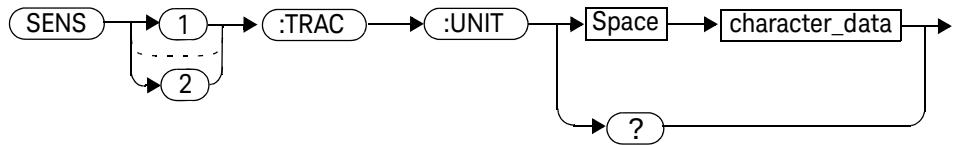

### Parameters

Item	Description/Default	Range of Values
character_data	- DBM: dBm - W: Watts	DBM W

### Example

**SENS2:TRAC:UNIT W**

*This command sets the trace units for Channel B to Watts.*

### Reset Condition

On reset the units are set to dBm.

## Query

```
[SENSe[1]]|SENSe2:TRACe:UNIT?
```

The query command returns the current value of character\_data.

## Query Example

```
SENS2:TRAC:UNIT?
```

*This command queries the current trace units for Channel B.*

## [SENSE[1]]|SENSE2:V2P ATYPe|DTYPe

This command is used to select the type of linearity correction that is applied to the channel sensors being used. For most 8480 Series sensors the correct (A type or D type) linearity correction table is automatically selected. However, for the V8486A and W8486A sensors the automatic selection must be overridden and the D type (diode) correction selected.

### Syntax

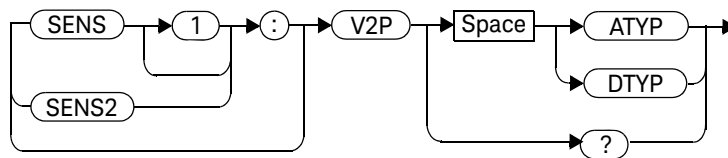

### Example

**SENS2:V2P DTYP**

*This command selects the D type linearity correction to be applied to Channel B.*

### Reset Condition

On reset, the linearity correction is set for A type.

### Query

**[SENSE[1]]|SENSE2:V2P?**

The query returns the current type of linearity correction being used (A type or D type).



## Query Example

**SENS:V2P?**

*This command queries which linearity correction type is currently being used on Channel A.*

## Error Messages

If no sensor is connected or the sensor is not an A type, the error -241, “Hardware missing” occurs.

## SENSe[1]|2:TRACe:LIMit:LOWer <numeric\_value>

This command sets the lower scale limit of the trace for the specified channel.

The units used are dependent on the current setting of `SENS:TRAC:UNIT` as shown in [Table 10-1](#).

**Table 10-1** Measurement units

Units: SENS:TRAC:UNIT	Units: SENS:TRAC:LIM:LOW
dBm	dBm
W	W

**NOTE**

The trace lower scale limit is maintained at a lower power than the upper scale limit which is adjusted to be slightly greater than the lower scale limit if necessary. Refer to “`SENSe[1]|2:TRACe:LIMit:UPPer <numeric_value>`” on page 412 for further information on setting the trace upper scale limit.

### Syntax

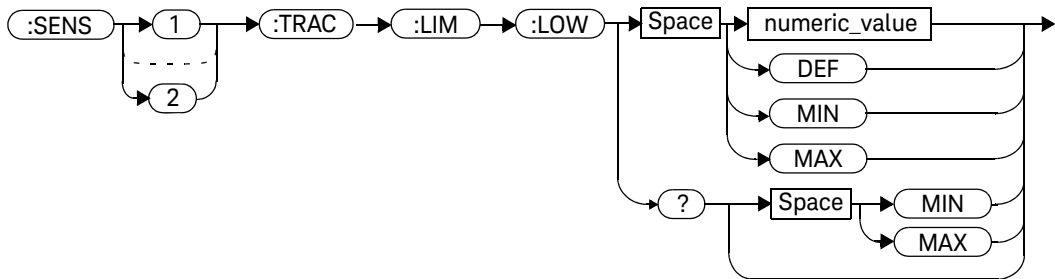

## Parameters

Item	Description/Default	Range of Values
numeric_value	A numeric value for the trace lower scale limit. <ul style="list-style-type: none"> <li>- <b>DEF</b>: the default is 20 dBm</li> <li>- <b>MIN</b>: -150 dBm</li> <li>- <b>MAX</b>: 230 dBm</li> </ul>	-150 to 230 dBm <b>DEF</b> <b>MIN</b> <b>MAX</b>

### Example

**SENSE2:TRAC:LIM:LOW 10**

*This command sets the trace lower scale limit to 10 dBm for Channel B.*

### Reset Condition

On reset, the value is set to -50 dBm.

### Query

**SENSE[1]|2:TRACe:LIMit:LOWer [MIN|MAX]**

The query returns the current setting of the trace lower scale limit or the value associated with **MIN** or **MAX**. The format of the response is **<NR3>**.

### Query Example

**SENSe:TRAC:LIM:LOW?**

*This command queries the trace lower scale limit of Channel A.*

## SENSe[1]|2:TRACe:LIMit:UPPer <numeric\_value>

This command sets the upper scale limit of the trace for the specified channel.

The units used are dependent on the current setting of `SENS:TRAC:UNIT` as shown in [Table 10-2](#).

**Table 10-2** Measurement units

Units: SENS:TRAC:UNIT	Units: SENS:TRAC:LIM:UPP
dBm	dBm
W	W

**NOTE**

The trace lower scale limit is maintained at a lower power than the upper scale limit which is adjusted to be slightly greater than the lower scale limit if necessary. Refer to “`SENSe[1]|2:TRACe:LIMit:LOWer <numeric_value>`” on page 410 for further information on setting the trace lower scale limit.

### Syntax

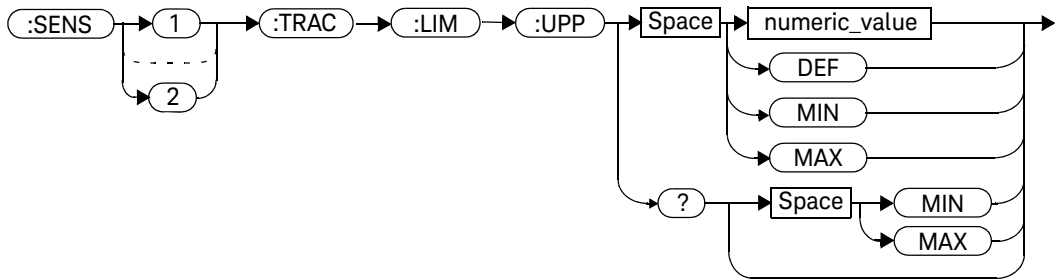

## Parameters

Item	Description/Default	Range of Values
numeric_value	A numeric value for the trace lower scale limit. <ul style="list-style-type: none"> <li>- <b>DEF</b>: the default is 20 dBm</li> <li>- <b>MIN</b>: -150 dBm</li> <li>- <b>MAX</b>: 230 dBm</li> </ul>	-150 to 230 dBm <b>DEF</b> <b>MIN</b> <b>MAX</b>

### Example

**SENS:TRAC:LIM:UPP 100**

*This command sets the trace upper scale limit to 100 dBm for Channel A.*

### Reset Condition

On reset, the value is set to **DEF**.

### Query

**SENSe[1]|2:TRACe:LIMit:LOWer [MIN|MAX]**

The query returns the current setting of the trace upper scale limit or the value associated with **MIN** or **MAX**. The format of the response is **<NR3>**.

### Query Example

**SENS:TRAC:LIM:UPP?**

*This command queries the trace upper scale limit of Channel A.*

## SENSe[1]|2:TRACe:X:SCALe:PDIV <numeric\_value>

This command is used to set the X Scale value (per division) for the selected trace.

### NOTE

This command is only applicable when N192x sensor is present and trigger acquisition mode is selected.

### Syntax

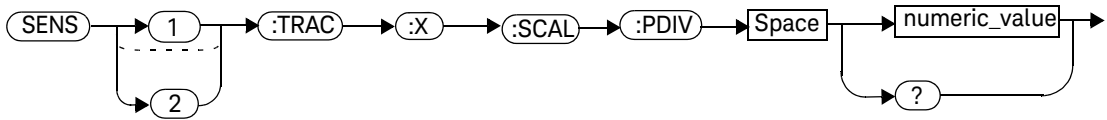

### Parameters

Item	Description/Default	Range of Values
numeric_value	The numeric value for X-axis scale.	2 ns to 0.1 s

### Example

**SENSe:TRAC:X:SCAL:PDIV 0.02** *This command sets the X Scale value of Channel A to 0.02 step.*

**SENSe2:TRAC:X:SCAL:PDIV 0.05** *This command sets the X Scale value of Channel B to 0.05 step.*

## Reset Condition

On reset, X Start = 0 s; X Scale = 10  $\mu$ s.

## Query

**SENSe[1]|2:TRACe:X:SCALE:PDIV?**

The query returns the current scale setting of X-axis in numerical value.

## Query Example

**SENS:TRAC:X:SCAL:PDIV?**

*This command queries the Channel A current X-axis scale setting in numerical value.*

## Error Messages

- If no sensor or wrong sensor is connected to the channel, error -241 "Hardware missing" occurs.
- If channel is not in trigger acquisition mode, error -221 "Settings conflict" occurs.
- If limits of the values keyed in are exceeded, error -222 "Data out of range; upper (or lower) limit exceeded; no change" occurs.

## SENSe[1]|2:TRACe:Y:SCALe:PDIV <numeric\_value>

This command is used to set the Y Scale value (per division) for the selected trace.

The Y Scale value set by this SCPI command is dependant on the current Y-axis unit, which can be set using **SENSe:TRAC:UNIT** command.

### NOTE

This command is only applicable when N192x sensor is present and trigger acquisition mode is selected.

### Syntax

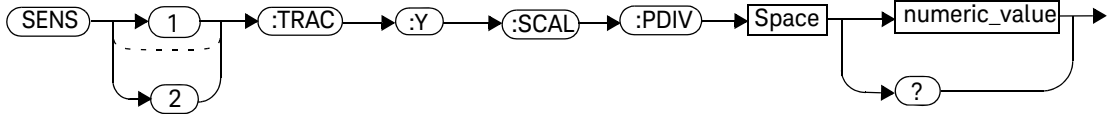

### Parameters

Item	Description/Default	Range of Values
numeric_value	The numeric value for Y-axis scale.	0.001 dB to 10 dB 1 nWatt to 10 MWatt



## Example

**SENS:TRAC:Y:SCAL:PDIV 0.002** *This command sets the Channel A Y Scale value to 0.002 step.*

**SENS2:TRAC:Y:SCAL:PDIV 0.05** *This command sets the Channel B Y Scale value to 0.05 step.*

## Reset Condition

On reset, Y Max = 20 dBm; Y Scale = 7 dB.

## Query

**SENSe[1]|2:TRACe:Y:SCALe:PDIV?**

The query returns the current scale setting of Y-axis in numerical value.

## Query Example

**SENS:TRAC:Y:SCAL:PDIV?** *This command queries the Channel A current Y-axis scale setting in numerical value.*

## Error Messages

- If no sensor or wrong sensor is connected to the channel, error -241 "Hardware missing" occurs.
- If channel is not in trigger acquisition mode, error -221 "Settings conflict" occurs.
- If limits of the values keyed in are exceeded, error -222 "Data out of range; upper (or lower) limit exceeded; no change" occurs.

THIS PAGE HAS BEEN INTENTIONALLY LEFT BLANK.

# 11 STATUS Subsystem

STATUS Subsystem	420
Status Register Set Commands	422
Device Status Register Sets	427
Operation Register Sets	429
STATUS:OPERation	430
STATUS:OPERation:CALibrating[:SUMMARY]	431
STATUS:OPERation:LLFail[:SUMMARY]	432
STATUS:OPERation:MEASuring[:SUMMARY]	433
STATUS:OPERation:SENSe[:SUMMARY]	434
STATUS:OPERation:TRIGger[:SUMMARY]	435
STATUS:OPERation:ULFail[:SUMMARY]	436
STATUS:PRESet	437
Questionable Register Sets	438
STATUS:QUEStionable	439
STATUS:QUEStionable:CALibration[:SUMMARY]	440
STATUS:QUEStionable:POWer[:SUMMARY]	441

This chapter explains how the **STATUS** command subsystem enables you to examine the status of the power meter by monitoring the “Device Status Register”, “Operation Status Register” and the “Questionable Status Register”.

## STATUS Subsystem

The **STATUS** command subsystem enables you to examine the status of the power meter by monitoring the following status registers:

- Device status register
- Operation status register
- Questionable status register

The contents of these and other registers in the power meter are determined by one or more status registers.

**Table 11-1** summarizes the effects of various commands and events on these status registers:

**Table 11-1** Commands and events affecting status register

Status Register	*RST	*CLS	Power On	STATUS: PRESet
SCPI Transition Filters (NTR and PTR registers)	none	none	preset	preset
SCPI Enable Registers	none	none	preset	preset
SCPI Event Registers	none	clear	clear	none
SCPI Error/Event Queue enable	none	none	preset	preset
SCPI Error/Event Queue	none	clear	clear	none
IEEE488.2 Registers ESE SRE	none	none	clear	none
IEEE488.2 Registers SESR STB	none	clear	clear	none

The contents of the status registers are examined using the following status register set commands:

```

:CONDition?
:ENABle <NRf>|<non-decimal numeric>
[:EVENT?]
:NTRansition <NRf>|<non-decimal numeric>
:PTRansition <NRf>|<non-decimal numeric>

```

Each of these can be used to examine any of the following eleven status registers:

`STATus:DEvice` (page 420)  
`STATus:OPERation` (page 430)  
`STATus:OPERation:CALibrating[:SUMMary]` (page 431)  
`STATus:OPERation:LLFail[:SUMMary]` (page 432)  
`STATus:OPERation:MEASuring[:SUMMary]` (page 433)  
`STATus:OPERation:SENSe[:SUMMary]` (page 434)  
`STATus:OPERation:TRIGger[:SUMMary]` (page 435)  
`STATus:OPERation:ULFail[:SUMMary]` (page 436)  
`STATus:QUEStionable` (page 437)  
`STATus:QUEStionable` (page 439)  
`STATus:QUEStionable:CALibration[:SUMMary]` (page 440)  
`STATus:QUEStionable:POWer[:SUMMary]` (page 441)

## Examples

- To use the `:CONDition?` command to examine the `STATus:DEvice` register:  
`STATus:DEvice:CONDition?`
- To use the `:NTRansition` command to examine the `STATus:OPERation:SENSe[:SUMMary]` register:  
`STATus:OPERation:SENSe[:SUMMary]:NTRansition`

This chapter describes the status register set commands and the status registers which they are used to examine.

## Status Register Set Commands

This section describes the five status register set commands. Each can be used to examine all of the eleven status registers listed on [page 421](#).

To apply a command to a specific register, prefix the command with the name of the appropriate register. For example, to apply the **:ENABLE** command to the **STATus:QUESTionable** register, use the following command:

**STATus:QUESTionable:ENABLE**

The Status Register Set commands detailed in this section are:

Keyword	Parameter Form	Notes	Page
:CONDition?		[query only]	<a href="#">page 422</a>
:ENABLE	<NRf> <non-decimal numeric>		<a href="#">page 423</a>
[ :EVENT?]		[query only]	<a href="#">page 423</a>
:NTRansition	<NRf> <non-decimal numeric>		<a href="#">page 424</a>
:PTRansition	<NRf> <non-decimal numeric>		<a href="#">page 425</a>

### :CONDition?

This query returns a 16 bit decimal-weighted number representing the bits set in the Condition Register of the SCPI Register Set you require to control. The format of the return is **<NR1>** in the range of 0 to 32767 ( $2^{15}-1$ ). The contents of the Condition Register remain unchanged after it is read.

### Syntax

.. → (:COND) → (?) →

[:EVENT]?

This query returns a 16 bit decimal-weighted number representing the bits set in the Event Register of the SCPI Register Set you require to control. The format of the return is <NR1> in the range of 0 to 32767 ( $2^{15}-1$ ). This query clears all bits in the register to 0.

Syntax



:ENABle <NRf>|<non-decimal numeric>

This command sets the Enable Register of the particular SCPI Register Set you require to control. The parameter value, when rounded to an integer and expressed in base 2 has its first 15 bits written into the Enable Register of the SCPI Register Set concerned. The last bit (bit 15) is always set to 0.

Syntax

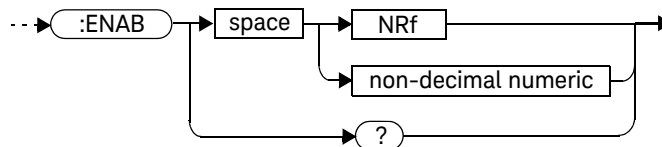

## Parameters

Type	Description	Range of Values
NRf non-decimal numeric	The value used to set the Enable Register.	0 to $2^{16}-1$

## Query

**:ENABle?**

The query returns a 15 bit decimal-weighted number representing the contents of the Enable Register of the SCPI Register Set being queried. The format of the return is **<NR1>** in the range of 0 to 32767 ( $2^{15}-1$ ).

**:NTRansition <NRf>|<non-decimal numeric>**

This command sets the Negative Transition Register of the SCPI Register Set you require to control. The parameter value, when rounded to an integer and expressed in base 2 has its first 15 bits written into the Negative Transition Register of the SCPI Register Set concerned. The last bit (bit 15) is always set to 0.



### Syntax

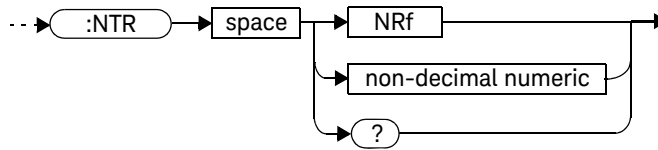

### Parameters

Type	Description	Range of Values
NRf	The value used to set the NTR Register.	0 to $2^{16}-1$
non-decimal numeric		

### Query

#### **:NTRansition?**

The query returns a 15 bit decimal-weighted number representing the contents of the Negative Transition Register of the SCPI register set being queried. The format of the return is **<NR1>** in the range of 0 to 32767 ( $2^{15}-1$ ).

#### **:PTRansition <NRf>|<non-decimal numeric>**

This command is used to set the Positive Transition Register of the SCPI Register Set you require to control. The first 15 bits of the input parameter are written into the Positive Transition Register of the SCPI Register Set concerned. The last bit (bit 15) is always set to 0.

## Syntax

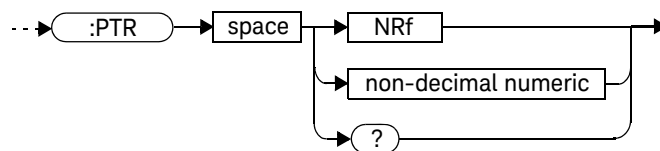

## Parameters

Type	Description	Range of Values
NRf	The value used to set the PTR Register.	0 to $2^{16}-1$
non-decimal numeric		

## Query

**:PTRansition?**

The query returns a 15 bit decimal-weighted number representing the contents of the Positive Transition Register of the SCPI register set being queried. The format of the return is **<NR1>** in the range of 0 to 32767 ( $2^{15}-1$ ).

## Device Status Register Sets

The status registers contain information which give device status information. The contents of the individual registers of these register sets may be accessed by appending the commands listed in “[Status Register Set Commands](#)”.

The following command descriptions detail the SCPI register you require to control but do not detail the register set commands.

The one device status register set is:

### **STATus:DEvice:**

The following bits in these registers are used by the power meter:

Bit Number	Decimal Weight	Definition
0	-	Not used
1	2	Channel A sensor connected
2	4	Channel B sensor connected
3	8	Channel A sensor error
4	16	Channel B sensor error
7-15	-	Not used
14	16384	Soft front panel button click
15	-	Bit 15 always 0

The Channel A and B sensor connected bits (bits 1 and 2), when queried with the **STATus:DEvice:CONDition?** query are set to:

- 1, when a power sensor is connected
- 0, when no power sensor is connected

The Channel A and B sensor connected bits (bits 1 and 2), when queried with the **STATus:DEvice:EVENT?** query indicate whether a power sensor has been connected or disconnected depending on the state of the corresponding bits of **STATus:DEvice:NTRansition** and **STATus:DEvice:PTRansition**. If the corresponding bit in:

- **STATus:DEvice:NTRansition** is 1, then **STATus:DEvice:EVENT?** is set when a power sensor is disconnected.
- **STATus:DEvice:PTRansition** is 1, then **STATus:DEvice:EVENT?** is set when a power sensor is connected.

**NOTE**

Querying **STATus:DEvice:EVENT?** clears the **STATus:DEvice:EVENT?** register.

---

The Channel A and B sensor error bits (3 and 4) are set to:

- 1, if the P-Series or E-Series power sensor EEPROM has failed.
- 0, for every other condition.

The Soft front panel button click bit (bit 14), when queried with the **STATus:DEvice:EVENT?** query indicates whether any soft front panel softkeys have been clicked since power up or since you last queried the device status register. This bit ignores the **:NTRansition**, and **:PTRansition** registers and a **:CONDition?** query always returns a 0.

## Operation Register Sets

The following registers contain information which is part of the power meter's normal operation. The contents of the individual registers of these register sets may be accessed by appending the commands listed in “[Status Register Set Commands](#)”.

The following command descriptions detail the SCPI register you require to control but do not detail the Register Set commands.

The seven Operation Register Sets are:

**STATUS:OPERation**

**STATus:OPERation:CALibrating[:SUMMARY]**

**STATus:OPERation:LLFail[:SUMMARY]**

**STATus:OPERation:MEASuring[:SUMMARY]**

**STATus:OPERation:SENSe[:SUMMARY]**

**STATus:OPERation:TRIGger[:SUMMARY]**

**STATus:OPERation:ULFail[:SUMMARY]**

Further information on these register sets is provided on the following pages.

## STATUS:OPERation

The operation status register set contains conditions which are a part of the operation of the power meter as a whole.

The following bits in these registers are used by the power meter:

Bit Number	Decimal Weight	Definition
0	1	CALibrating Summary
1	2	Self Test Started
2 - 3	-	Not used
4	16	MEASuring Summary
5	32	Waiting for TRIGger Summary
6 - 9	-	Not used
10	1024	SENSE Summary
11	2048	Lower Limit Fail Summary
12	4096	Upper Limit Fail Summary
13 to 15	-	Not used (bit 15 always 0)

### Syntax

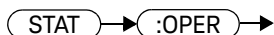

#### NOTE

The Self Test Started bit is set to 1 when Self Test is in progress and set to 0 when Self Test is completed.

## STATus:OPERation:CALibrating[:SUMM]ary]

The operation status calibrating summary register set contains information on the calibrating status of the power meter.

The following bits in these registers are used by the power meter:

Bit Number	Decimal Weight	Definition
0	-	Not used
1	2	Channel A CALibrating Status
2	4	Channel B CALibrating Status
3-15	-	Not used

These bits are set at the beginning of zeroing (**CALibration:ZERO:AUTO ONCE**) and at the beginning of calibration (**CALibration:AUTO ONCE**). Also for the compound command/query **CALibration[:ALL]?**, this bit is set at the beginning of the calibration sequence.

These bits are cleared at the end of zeroing or calibration.

### Syntax

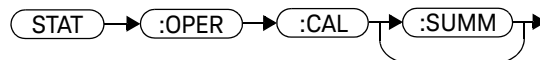

## STATUS:OPERation:LLFail[:SUMMARY]

The operation status lower limit fail summary register set contains information on the lower limit fail status of the power meter.

The following bits in these registers are used by the power meter:

Bit Number	Decimal Weight	Definition
0	-	Not used
1	2	Channel A LLFail Status
2	4	Channel B LLFail Status
3	8	Upper window LLFail Status
4	16	Lower window LLFail Status
5	32	Upper window lower measurement LLFail Status
6	64	Lower window lower measurement LLFail Status
7-15	-	Not used

The appropriate bits are set if a channel lower limit test fails or a window lower limit test fails.

These bits are cleared if a measurement is made and the test is enabled and passes.

### Syntax

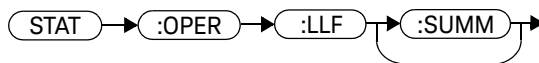



## STATus:OPERation:MEASuring[:SUMMary]

The operation status measuring summary register set contains information on the measuring status of the power meter.

The following bits in these registers are used by the power meter:

Bit Number	Decimal Weight	Definition
0	-	Not used
1	2	Channel A MEASuring Status
2	4	Channel B MEASuring Status
3-15	-	Not used

These bits are set when the power meter is taking a measurement.

These bits are cleared when the measurement is finished.

### Syntax

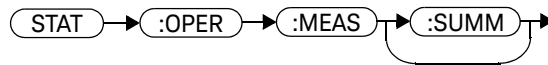

## STATus:OPERation:SENSe[:SUMM]ary]

The operation status sense summary register set contains information on the status of the power sensors.

The following bits in these registers are used by the power meter:

Bit Number	Decimal Weight	Definition
0	-	Not used
1	2	Channel A SENSE Status
2	4	Channel B SENSE Status
3-15	-	Not used

These bits are set when the power meter is reading data from the E-Series power sensor EEPROM.

These bits are cleared when the power meter is not reading data from the E-Series power sensor EEPROM.

### Syntax

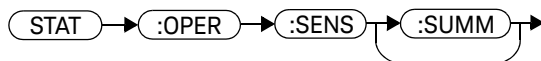

## STATus:OPERation:TRIGger[:SUMM]ary

The operation status trigger summary register set contains information on the trigger status of the power meter.

The following bits in these registers are used by the power meter:

Bit Number	Decimal Weight	Definition
0	-	Not used
1	2	Channel A TRIGger Status
2	4	Channel B TRIGger Status
3-15	-	Not used

### Syntax

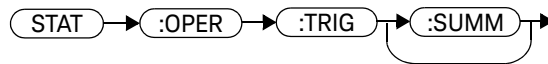

## STATUS:OPERation:ULFail[:SUMM]ary]

The operation status upper limit fail summary register set contains information on the upper limit fail status of the power meter.

The following bits in these registers are used by the power meter:

Bit Number	Decimal Weight	Definition
0	-	Not used
1	2	Channel A ULFail Status
2	4	Channel B ULFail Status
3	8	Upper window ULFail Status
4	16	Lower window ULFail Status
5	32	Upper window lower measurement LLFail Status
6	64	Lower window lower measurement LLFail Status
7-15	-	Not used

The appropriate bits are set if a channel upper limit test fails or a window upper limit test fails.

These bits are cleared if a measurement is made and the test is enabled and passes.

### Syntax

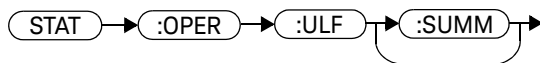

## STATUS:PRESet

**PRESet** sets a number of the status registers to their preset values as shown below  
 - all other registers are unaffected. Bit 15 is always 0.

Register	Filter/Enable	PRESet Value
OPERational	ENABLE	all zeros
	PTR	all ones
	NTR	all zeros
QUESTionable	ENABLE	all zeros
	PTR	all ones
	NTR	all zeros
All Others	ENABLE	all ones
	PTR	all ones
	NTR	all zeros

### Syntax



## Questionable Register Sets

The questionable register sets contain information which gives an indication of the quality of the data produced by the power meter. The contents of the individual registers in these register sets may be accessed by appending the commands listed in “[Status Register Set Commands](#)”.

The following command descriptions detail the SCPI register you require to control but do not detail the register set commands.

The three questionable register sets are:

**STATus:QUEStionable**

**STATus:QUEStionable:CALibration[:SUMMary]**

**STATus:QUEStionable:POWer[:SUMMary]**

## STATus:QUEStionable

The questionable register set contains bits that indicate the quality of various aspects of signals processed by the power meter.

The following bits in these registers are used by the power meter:

Bit Number	Decimal Weight	Definition
0 to 2	-	Not used
3	8	POWer Summary
4 to 7	-	Not used
8	256	CALibration Summary
9	512	Power On Self Test
10 to 15	-	Not Used (bit 15 always 0)

Bit 3 is set by the logical OR outputs of the **STATus:QUEStionable:POWer:SUMMARY** register set.

Bit 8 is set by the logical OR outputs of the **STATus:QUEStionable:CALibration:SUMMARY** register set.

Bit 9 is set if power-on self-test fails, and cleared if it passes.

### Syntax

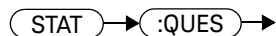

## STATUS:QUESTIONABLE:CALibration[:SUMMARY]

The questionable calibration summary register set contains bits which give an indication of the quality of the data produced by the power meter due to its calibration status.

The following bits in these registers are used by the power meter:

Bit Number	Decimal Weight	Definition
0	-	Not used
1	2	Summary of Channel A CALibration
2	4	Summary of Channel B CALibration
3-15	-	Not used

These bits are set by the following:

- Error -231, "Data questionable; CH<A|B>:ZERO ERROR"
- Error -231, "Data questionable; CAL ERROR"
- Error -231, "Data questionable; CAL ERROR ChA"
- Error -231, "Data questionable; CAL ERROR ChB"

These bits are cleared when any of the three commands listed above succeed and no errors are placed on the error queue.

### Syntax

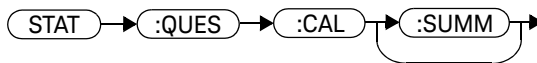



## STATus:QUEStionable:POWer[:SUMMArY]

The questionable power summary register set contain bits that indicate the quality of the power data being acquired by the power meter.

The following bits in these registers shall be used by the power meter:

Bit Number	Decimal Weight	Definition
0	-	Not used
1	2	Channel A Power
2	4	Channel B Power
3	8	Upper Window Power
4	16	Lower Window Power
5	32	Channel A Please Zero
6	64	Channel B Please Zero
7	128	Upper Window Lower Measurement Power
8	256	Lower Window Lower Measurement Power

Bit 1 is set when any of the following errors occur:

- Error -231, "Data questionable;Input Overload"
- Error -231, "Data questionable;Input Overload ChA"

Bit 2 is set when the following error occurs:

- Error -231, "Data questionable;Input Overload ChB"

Bits 3 is set when the following error occurs:

- Error -230, "Data corrupt or stale"
- Error -231, "Data questionable;Upper window log error"

Bit 4 is set when the following error occurs:

- Error -230, "Data corrupt or stale"
- Error -231, "Data questionable;Lower window log error"

Bit 5 is set when the following condition occurs:

## 11 STATus Subsystem

- Channel A requires zeroing

Bit 6 is set when the following condition occurs:

- Channel B requires zeroing

These bits are cleared when no errors or events are detected by the power meter during a measurement covering the causes given for it to set.

### Syntax

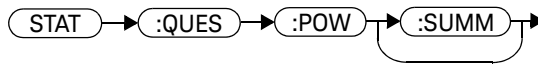

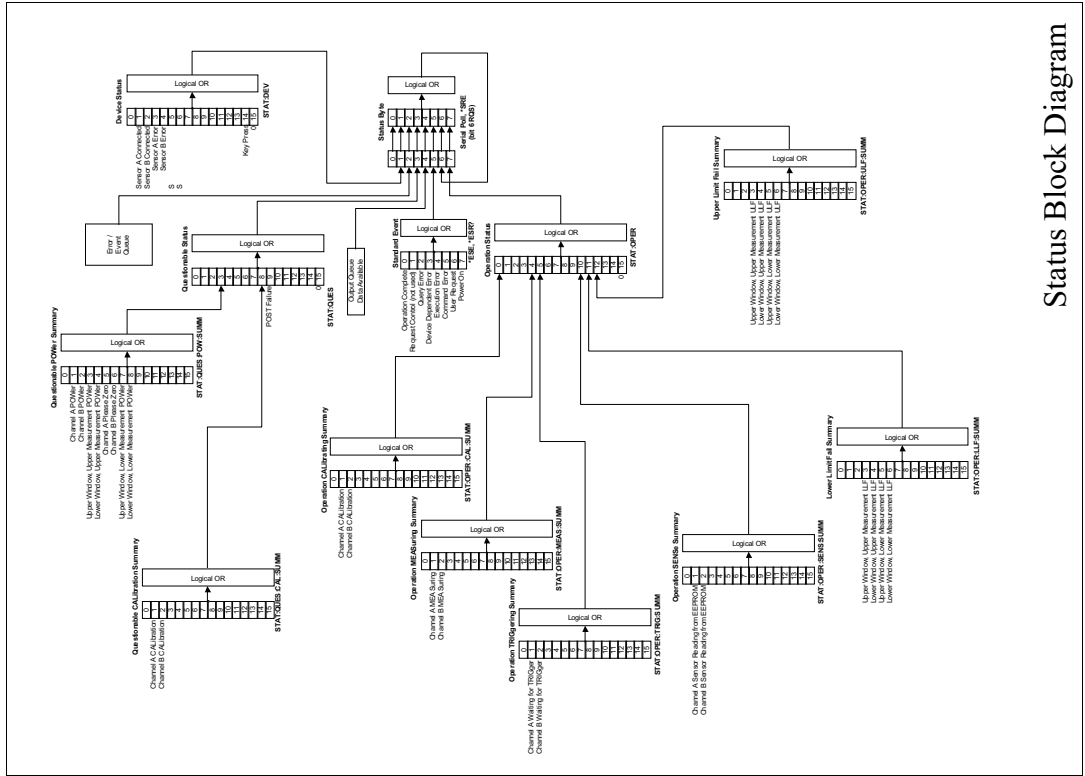

Status Block Diagram

THIS PAGE HAS BEEN INTENTIONALLY LEFT BLANK.

# 12 SYSTEM Subsystem

SYSTEM Subsystem	446
SYSTEM:COMMunicate:LAN:AIP[:STATe] <boolean>	448
SYSTEM:COMMunicate:LAN:CURREnt:ADDResS?	449
SYSTEM:COMMunicate:LAN:CURREnt:DGATeway?	450
SYSTEM:COMMunicate:LAN:CURREnt:DNAMe?	451
SYSTEM:COMMunicate:LAN:CURREnt:SMASK?	452
SYSTEM:COMMunicate:LAN:ADDResS <character_data>	453
SYSTEM:COMMunicate:LAN:DGATeway <character_data>	454
SYSTEM:COMMunicate:LAN:DHCP[:STATe] <boolean>	455
SYSTEM:COMMunicate:LAN:DNAMe <character_data>	456
SYSTEM:COMMunicate:LAN:HNAME <character_data>	457
SYSTEM:COMMunicate:LAN:MAC?	458
SYSTEM:COMMunicate:LAN:REStArt	459
SYSTEM:COMMunicate:LAN:SMASK <character_data>	460
SYSTEM:DISPlay:BMP	461
SYSTEM:ERRor?	462
SYSTEM:HELP:HEADers?	469
SYSTEM:PERSonA:MANUFACTURer <character_data>	470
SYSTEM:PERSonA:MANUFACTURer:DEFault	472
SYSTEM:PRESet <character_data>	473
SYSTEM:VERSion?	535

This chapter explains how to use the **SYSTEM** command subsystem to return error numbers and messages from the power meter, preset the power meter, set the remote address, and query the SCPI version.

## SYSTem Subsystem

The **SYSTem** command subsystem is used to:

- Return error numbers and messages from the power meter
- Preset the power meter
- Set the LAN address
- Set the command language
- Query the SCPI version

Keyword	Parameter Form	Notes	Page
SYSTem			
:COMMunicate			
:LAN			
:AIP			
	[ :STATe]	<boolean>	page 448
:CURRent			
	:ADDRess?	[query only]	page 449
	:DGATeway?	[query only]	page 450
	:DNAME?	[query only]	page 451
	:SMASK?	[query only]	page 452
	:ADDRess	<character_data>	page 453
	:DGATeway	<character_data>	page 454
:DHCP			
	[ :STATe]	<boolean>	page 455
	:DNAME	<character_data>	page 456
	:HNAME	<character_data>	page 457
	:MAC?	[query only]	page 458
	:REStart	[no query]	page 459

Keyword	Parameter Form	Notes	Page
:SMASK	<character_data>		page 460
:DISPLAY			
:BMP?		[query only]	page 461
:ERRor			page 462
:HELP			
:HEADers?		[query only]	page 469
:PERSONa:			
MANufacturer	<character_data>		page 470
:DEFauIt			page 472
:PRESet	<character_data>	[event; no query]	page 473
:VERSion?		[query only]	page 535

## SYSTem:COMMunicate:LAN:AIP[:STATe] <boolean>

This command enables the AutoIP protocol to dynamically assign the IP address when connecting to the power meter in an isolated (non-site) LAN network (for example, laptop to power meter).

### Syntax

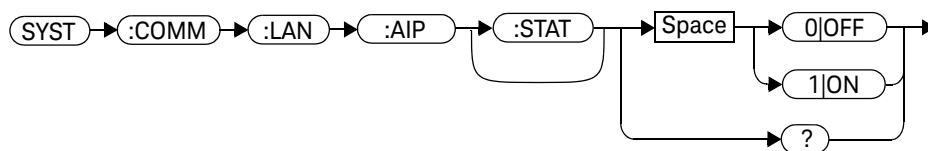

### Example

**SYST:COMM:LAN:AIP ON**

*This command enables the AutoIP*

### Query

**SYSTem:COMMunicate:LAN:AIP?**

- 1 is returned if AutoIP is enabled
- 0 is returned if AutoIP is disabled

### Query Example

**SYST:COMM:LAN:AIP?**

*This command queries the state of the AutoIP.*



## SYSTEM:COMMunicate:LAN:CURRent:ADDRess?

This command returns the current setting of the IP address in use by the power meter.

### NOTE

If DHCP or AutoIP are enabled and successful, then one of these IP address modes assigns the IP address, otherwise it is the static IP address.

---

### Syntax

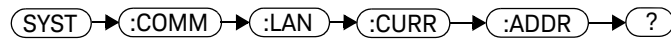

### Example

`SYST:COMM:LAN:CURR:ADDR?`

*This command queries the current setting of the IP address.*

## SYSTem:COMMunicate:LAN:CURRent:DGATeway?

This command returns the current setting of the LAN IP router/gateway address in use by the power meter.

**NOTE**

If DHCP or AutoIP are enabled and successful, then one of these IP address modes assigns the LAN IP router/gateway address, otherwise it is the static LAN IP router/gateway address

---

### Syntax



### Example

`SYST:COMM:LAN:CURR:DGAT?`

*This command queries the current setting of the LAN IP router/gateway address.*

## SYSTEM:COMMunicate:LAN:CURRENT:DNAMe?

This command returns the current setting of the LAN domain name in use by the power meter.

### NOTE

If DHCP or AutoIP are successfully enabled, then one of these IP address modes assign the LAN domain name, otherwise it is the static LAN domain name.

---

### Syntax

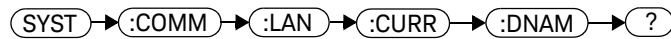

### Example

**SYST:COMM:LAN:CURR:DNAM?**

*This command queries the current setting of the LAN domain name.*

## SYSTem:COMMunicate:LAN:CURRent:SMASk?

This command returns the current setting of the LAN subnet mask in use by the power meter.

**NOTE**

If DHCP or AutoIP are successfully enabled, then one of these IP address modes assign the LAN subnet mask, otherwise it is the static LAN subnet mask.

---

### Syntax

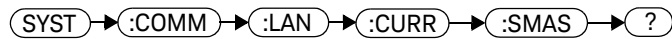

### Example

**SYST:COMM:LAN:CURR:SMAS?**

*This command queries the current setting of the LAN subnet mask.*

# SYSTEM:COMMunicate:LAN:ADDRESS <character\_data>

This command sets the LAN (IP) address of the power meter.

## Syntax

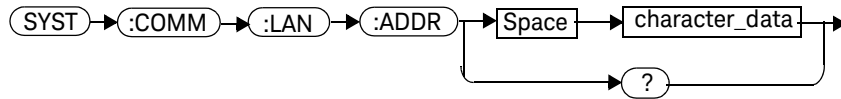

## Parameters

Item	Description	Range of Values
character_data	Numeric character values for the address. Up to 15 characters, formatted as follows: A.B.C.D where A, B, C, D = 0 to 225	0 to 225 (no embedded spaces)

## Example

**SYST:COMM:LAN:ADDR**  
**'130.015.156.255'**

*This command sets the LAN IP address to 130.015.156.255.*

## Query

**SYSTEM:COMMunicate:LAN:ADDRESS?**

The query returns the current setting of the LAN address.

## Query Example

**SYST:COMM:LAN:ADDR?**

*This command queries the setting of the LAN IP address.*

## SYSTem:COMMunicate:LAN:DGATeway <character\_data>

This command sets the LAN IP router/gateway address for the power meter.

### Syntax

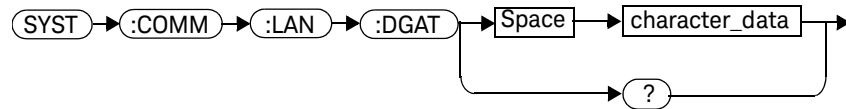

### Parameters

Item	Description	Range of Values
character_data	Numeric character values for the address. Up to 15 characters, formatted as follows: A.B.C.D where A, B, C, D = 0 to 225	0 to 225 (no embedded spaces)

### Example

**SYST:COMM:LAN:DGAT**  
**'130.2.6.200'**

*This command sets the gateway address to 130.2.6.200.*

### Query

**SYSTem:COMMunicate:LAN:DGAT?**

The query returns the current setting of the LAN gateway address.

### Query Example

**SYST:COMM:LAN:DGAT?**

*This command queries the setting of the gateway address.*

## SYSTEM:COMMunicate:LAN:DHCP[:STATe] <boolean>

This command enables the dynamic host configuration protocol.

### Syntax

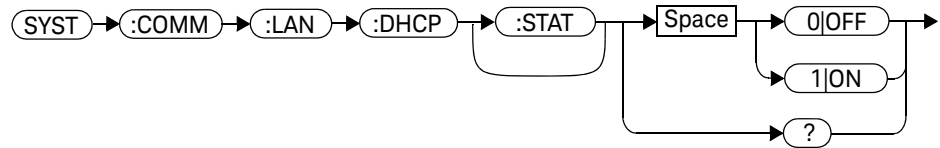

### Example

**SYSTEM:COMM:LAN:DHCP ON**

*This command enables the DHCP.*

### Query

**SYSTEM:COMMunicate:LAN:DHCP?**

- 1 is returned if DHCP is enabled
- 0 is returned if DHCP is disabled

### Query Example

**SYSTEM:COMM:LAN:DHCP?**

*This command queries the state of the DHCP.*

## SYSTem:COMMunicate:LAN:DNAMe <character\_data>

This command sets the domain name for the power meter.

### Syntax

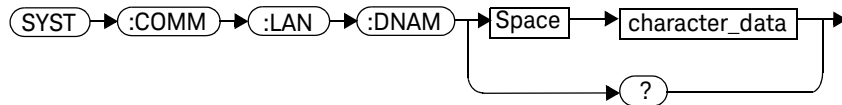

### Parameters

Item	Description	Range of Values
character_data	Character values of up to 16 characters	Maximum of 16 characters

### Example

**SYST:COMM:LAN:DNAM**  
**'myco.com'**

*This command sets the hostname to myco.com.*

### Query

**SYSTem:COMMunicate:LAN:DNAM?**

The query returns the current setting of the LAN domain name.

### Query Example

**SYST:COMM:LAN:DNAM?**

*This command queries the setting of the domain name.*



## SYSTEM:COMMunicate:LAN:HNAME <character\_data>

This command sets the hostname for the power meter.

The factory default setting of hostname is in this format:

**K - + product number + - + suffix 5 digits of serial number**

For example, **K-N8262A-00204**

### Syntax

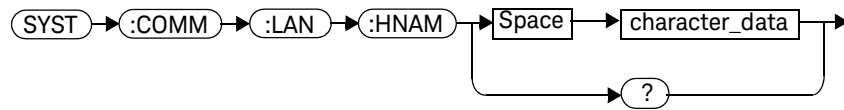

### Parameters

Item	Description	Range of Values
character_data	Character values of up to 15 characters	Maximum of 15 characters

### Example

**SYST:COMM:LAN:HNAME**  
**'PowerMeter1'**

*This command sets the hostname to PowerMeter 1.*

### Query

**SYSTEM:COMMunicate:LAN:HNAME?**

The query returns the current setting of the LAN hostname.

### Query Example

**SYST:COMM:LAN:HNAME?**

*This command queries the setting of the hostname.*

## SYSTem:COMMunicate:LAN:MAC?

This query returns the LAN MAC address.

### Syntax

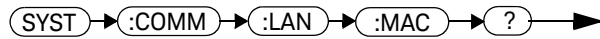

### Example

**SYST:COMM:LAN:MAC?**

*This command queries the current MAC address.*

## SYSTEM:COMMunicate:LAN:REStart

This command restarts the power meter's network stack; any LAN configuration changes can only take effect after this is performed.

### Syntax

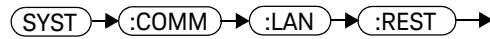

### Example

**SYST:COMM:LAN:REST**

*This command restarts the LAN network with new configuration.*

## SYSTem:COMMunicate:LAN:SMASk <character\_data>

This command sets the subnet mask of the power meter.

### Syntax

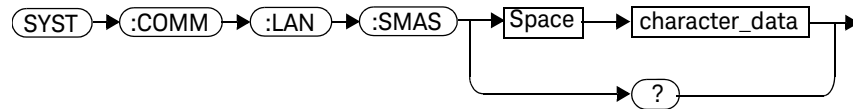

### Parameters

Item	Description	Range of Values
character_data	Numeric character values for the address. Up to 15 characters, formatted as follows: A.B.C.D where A, B, C, D = 0 to 225	0 to 225 (no embedded spaces)

### Example

```
SYST:COMM:LAN:SMAS
'255.255.248.0'
```

*This command sets the subnet mask to 255.255.248.0.*

### Query

```
SYSTem:COMMunicate:LAN:SMASk?
```

The query returns the current setting of the LAN subnet mask.

### Query Example

```
SYST:COMM:LAN:SMAS?
```

*This command queries the setting of the LAN subnet mask.*

## SYSTEM:DISPlay:BMP

This command returns the display image in bitmap format.

This command is limited to a maximum of five image returns per second.

### NOTE

It is not recommended to use this command in Fast Mode, as it slows down the measurement rate.

---

### Syntax

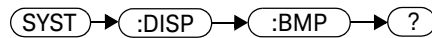

### Example

**SYST:DISP:BMP?**

*This command returns the display image in bitmap format.*

## SYSTem:ERRor?

This query returns error numbers and messages from the power meter's error queue. When an error is generated by the power meter, it stores an error number and corresponding message in the error queue. One error is removed from the error queue each time this command is executed. The errors are cleared in the order of first-in first-out, this is the oldest errors are cleared first. To clear all the errors from the error queue, execute **\*CLS** command. When the error queue is empty, subsequent **SYSTem:ERRor?** queries return a +0, "No error" message. The error queue has a maximum capacity of 30 errors.

### Syntax

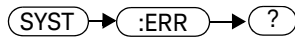

### Example

**SYST:ERR?**

*This command queries the oldest error message stored in the power meter's error queue.*

### Reset Condition

On reset, the error queue is unaffected.

### Error Messages

- If the error queue overflows, the last error is replaced with –350, "Queue overflow". No additional errors are accepted by the queue until space becomes available.

## Error Message List

-101	<p>Invalid character</p> <p>An invalid character was found in the command string. You may have inserted a character such as #, \$, or % in the command header or within a parameter.</p> <p>For example, LIM:LOW O#.</p>
-102	<p>Syntax error</p> <p>Invalid syntax was found in the command string.</p> <p>For example, LIM:CLE:AUTO, 1 or LIM:CLE: AUTO 1.</p>
-103	<p>Invalid separator</p> <p>An invalid separator was found in the command string. You may have used a comma instead of a colon, semicolon, or blank space; or you may have used a blank space instead of a comma.</p> <p>For example, OUP:ROSC,1.</p>
-105	<p>GET not allowed</p> <p>A Group Execute Trigger (GET) is not allowed within a command string.</p>
-108	<p>Parameter not allowed</p> <p>More parameters were received than expected for the command. You may have entered an extra parameter, or added a parameter to a command that does not accept a parameter.</p> <p>For example, CAL 10.</p>
-109	<p>Missing parameter</p> <p>Fewer parameters were received than expected for the command. You omitted one or more parameters that are required for this command.</p> <p>For example, AVER:COUN.</p>
-112	<p>Program mnemonic too long</p> <p>A command header was received which contained more than the maximum 12 characters allowed.</p> <p>For example, SENSseAVERAgeCOUNt 8.</p>
-113	<p>Undefined header</p> <p>A command was received that is not valid for this power meter. You may have misspelled the command, it may not be a valid command or you may have the wrong interface selected. If you are using the short form of the command, remember that it may contain up to four letters.</p> <p>For example, TRIG:SOUR IMM.</p>
-121	<p>Invalid character in number</p> <p>An invalid character was found in the number specified for a parameter value.</p> <p>For example, SENS:AVER:COUN 128#H.</p>

---

-123	Exponent too large A numeric parameter was found whose exponent was larger than 32,000. For example, SENS:COUN 1E34000.
-124	Too many digits A numeric parameter was found whose mantissa contained more than 255 digits, excluding leading zeros.
-128	Numeric data not allowed A numeric value was received within a command which does not accept a numeric value. For example, MEM:CLE 24.
-131	Invalid suffix A suffix was incorrectly specified for a numeric parameter. You may have misspelled the suffix. For example, SENS:FREQ 200KZ.
-134	Suffix too long A suffix used contained more than 12 characters. For example, SENS:FREQ 2MHZZZZZZZZZZ.
-138	Suffix not allowed A suffix was received following a numeric parameter which does not accept a suffix. For example, INIT:CONT 0Hz.
-148	Character data not allowed A discrete parameter was received but a character string or a numeric parameter was expected. Check the list of parameters to verify that you have used a valid parameter type. For example, MEM:CLE CUSTOM_1.
-151	Invalid string data An invalid string was received. Check to see if you have enclosed the character string in single or double quotes. For example, MEM:CLE "CUSTOM_1.
-158	String data not allowed A character string was received but is not allowed for the command. Check the list of parameters to verify that you have used a valid parameter type. For example, LIM:STAT 'ON'.
-161	Invalid block data A block data element was expected but was invalid for some reason. For example, *DDT #15FET. The 5 in the string indicates that 5 characters should follow, whereas in this example there are only 3.

---



-168	<p>Block data not allowed</p> <p>A legal block data element was encountered but not allowed by the power meter at this point. For example SYST:LANG #15FETC?.</p>
-178	<p>Expression data not allowed</p> <p>A legal expression data was encountered but not allowed by the power meter at this point. For example SYST:LANG (5+2).</p>
-211	<p>Trigger ignored</p> <p>Indicates that &lt;GET&gt; or *TRG, or TRIG:IMM was received and recognized by the device but was ignored because the power meter was not in the wait for trigger state.</p>
-213	<p>Init ignored</p> <p>Indicates that a request for a measurement initiation was ignored as the power meter was already initiated. For example, INIT:CONT ON INIT.</p>
-214	<p>Trigger deadlock</p> <p>TRIG:SOUR was set to HOLD or BUS and a READ? or MEASure? was attempted, expecting TRIG:SOUR to be set to IMMEDIATE.</p>
-220	<p>Parameter error;Frequency list must be in ascending order.</p> <p>Indicates that the frequencies entered using the MEMory:TABLE:FREQuency command are not in ascending order.</p>
-221	<p>Settings conflict</p> <p>This message occurs under a variety of conflicting conditions. The following list gives a few examples of where this error may occur:</p> <ul style="list-style-type: none"> <li>If the READ? parameters do not match the current settings.</li> <li>If you are in fast mode and attempting to switch on for example, averaging, duty cycle or limits.</li> <li>Trying to clear a sensor calibration table when none is selected.</li> </ul>
-222	<p>Data out of range</p> <p>A numeric parameter value is outside the valid range for the command. For example, SENS:FREQ 2KHZ.</p>
-224	<p>Illegal parameter value</p> <p>A discrete parameter was received which was not a valid choice for the command. You may have used an invalid parameter choice. For example, TRIG:SOUR EXT.</p>

-226	Lists not same length This occurs when SENSE:CORRection:CSET[1]]CSET2:STATe is set to ON and the frequency and calibration/offset lists do not correspond in length.
-230	Data corrupt or stale;Please calibrate Channel B When CAL[1]2]:RCAL is set to ON and the sensor currently connected to Channel B has not been calibrated, then any command which would normally return a measurement result (for example FETC?, READ?, or MEAS?) will generate this error message.
-231	Data questionable;CAL ERROR Power meter calibration failed. The most likely cause is attempting to calibrate without applying a 1 mW power to the power sensor.
-231	Data questionable;CAL ERROR ChA Power meter calibration failed on Channel A. The most likely cause is attempting to calibrate without applying a 1 mW power to the power sensor.
-231	Data questionable;CAL ERROR ChB Power meter calibration failed on Channel B. The most likely cause is attempting to calibrate without applying a 1 mW power to the power sensor.
-231	Data questionable;Input Overload The power input to Channel A exceeds the power sensor's maximum range.
-231	Data questionable;Input Overload ChA The power input to Channel A exceeds the power sensor's maximum range.
-231	Data questionable;Input Overload ChB The power input to Channel B exceeds the power sensor's maximum range.
-231	Data questionable;Lower window log error This indicates that a difference measurement in the lower window has given a negative result when the units of measurement were logarithmic.
-231	Data questionable;Upper window log error This indicates that a difference measurement in the upper window has given a negative result when the units of measurement were logarithmic.
-231	Data questionable;ZERO ERROR Power meter zeroing failed. The most likely cause is attempting to zero when some power signal is being applied to the power sensor.
-231	Data questionable;ZERO ERROR ChA Power meter zeroing failed on Channel A. The most likely cause is attempting to zero when some power signal is being applied to the power sensor.

-231	Data questionable;ZERO ERROR ChB Power meter zeroing failed on Channel B. The most likely cause is attempting to zero when some power signal is being applied to the power sensor.
-241	Hardware missing The power meter is unable to execute the command because either no power sensor is connected or it expects an E-Series power sensor and one is not connected.
-310	System error;Dty Cyc may impair accuracy with ECP sensor This indicates that the sensor connected is for use with CW signals only.
-310	System error;Ch A Dty Cyc may impair accuracy with ECP sensor This indicates that the sensor connected to Channel A is for use with CW signals only.
-310	System error;Ch B Dty Cyc may impair accuracy with ECP sensor This indicates that the sensor connected to Channel B is for use with CW signals only.
-310	System error;Sensor EEPROM Read Failed - critical data not found or unreadable This indicates a failure with your E-Series power sensor. Refer to your power sensor manual for details on returning it for repair.
-310	System error;Sensor EEPROM Read Completed OK but optional data block(s) not found or unreadable This indicates a failure with your E-Series power sensor. Refer to your power sensor manual for details on returning it for repair.
-310	System error;Sensor EEPROM Read Failed - unknown EEPROM table format This indicates a failure with your E-Series power sensor. Refer to your power sensor manual for details on returning it for repair.
-310	System error;Sensor EEPROM < > data not found or unreadable Where < > refers to the sensor data block covered, for example, Linearity, Temp - Comp (temperature compensation). This indicates a failure with your E-Series power sensor. Refer to your power sensor manual for details on returning it for repair.
-321	Out of memory The power meter required more memory than was available to run an internal operation.
-330	Self-test Failed; The -330, "Self-test Failed" errors indicate that you have a problem with your power meter. Refer to Contacting Keysight Technologies on page 119 for details of what to do with your faulty power meter.
-330	Self-test Failed;Measurement Channel Fault
-330	Self-test Failed;Measurement Channel A Fault

-330	Self-test Failed;Measurement Channel B Fault
-330	Self-test Failed;Calibrator Fault Refer to “Calibrator” on page 104 if you require a description of the calibrator test.
-330	Self-test Failed;ROM Check Failed
-330	Self-test Failed;RAM Check Failed
-330	Self-test Failed;Display Assy. Fault Refer to “Display” on page 104 if you require a description of the Display test.
-350	Queue overflow The error queue is full and another error has occurred which could not be recorded.
-361	Parity error in program The serial port receiver has detected a parity error and consequently, data integrity cannot be guaranteed.
-362	Framing error in program The serial port receiver has detected a framing error and consequently, data integrity cannot be guaranteed.
-363	Input buffer overrun The serial port receiver has been overrun and consequently, data has been lost.
-410	Query INTERRUPTED A command was received which sends data to the output buffer, but the output buffer contained data from a previous command (the previous data is not overwritten). The output buffer is cleared when power has been off, or after *RST (reset) command has been executed.
-420	Query UNTERMINATED The power meter was addressed to talk (that is, to send data over the interface) but a command has not been received which sends data to the output buffer. For example you may have executed a CONFIGure command (which does not generate data) and then attempted to read data from the remote interface.
-430	Query DEADLOCKED A command was received which generates too much data to fit in the output buffer and the input buffer is also full. Command execution continues but data is lost.
-440	Query UNTERMINATED after indefinite response The *IDN? command must be the last query command within a command string.

# SYSTEM:HELP:HEADers?

This query returns a list of all SCPI commands supported by the instrument. Data is returned in IEEE 488.2 arbitrary block program data format as shown in [Figure 12-1](#) below.

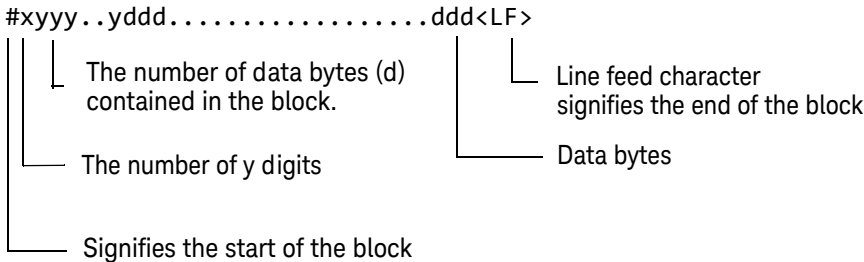

Example: if there are 12435 data bytes, y = 12435 and x = 5

**Figure 12-1** IEEE 488.2 Arbitrary block program data format

Each point in the trace is represented as an IEEE 754 32 bit floating point number, made up of four bytes in the data block. The MS byte is transmitted first. Each complete block is terminated by a line feed.

Commands are listed in alphabetical order.

## Syntax

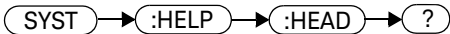

## Example

SYSTEM:HELP:HEAD?

*This command returns the SCPI commands supported by the instrument.*

## SYSTem:PERSonA:MANufacturer <character\_data>

This command only accepts two non-case sensitive strings “Agilent Technologies” and “Keysight Technologies”. A power cycle or reboot is required for the changes in the instrument’s manufacturer string to take effect and to be recognized in the Keysight Connection Expert. The string will remain for the subsequent power cycle or reboot.

### Syntax

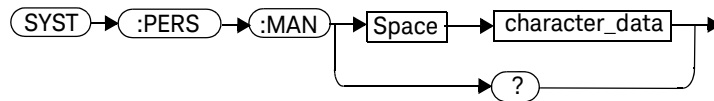

### Parameters

Item	Description	Range of Values
character_data	Manufacturer string for *IDN? and web pages.	"Agilent Technologies" or "Keysight Technologies"

### Examples

**SYST:PERSonA:MAN "Agilent Technologies"** *This command sets the instrument’s manufacturer to “Agilent Technologies”.*

**SYST:PERSonA:MAN "Keysight Technologies"** *This command sets the instrument’s manufacturer to “Keysight Technologies”.*

### Reset condition

On reset, the manufacturer string is not affected.

## Query

**SYSTem:PERSonA:MANufacturer?**

The query returns the manufacturer string that was set.

## Query Example

**SYST:PERS:MAN?** *Queries the manufacturer string that was set.*

## Error Message

If <character\_data> is not set to **“Agilent Technologies”** or **“Keysight Technologies”**, error -158, “String data not allowed” occurs.

## SYSTem:PERSonA:MANuufacturer:DEFault

This command sets the instrument's manufacturer to "Keysight Technologies" which is the default manufacturer setting.

### Syntax

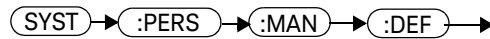

### Example

**SYST:PERS:MAN:DEF**      *This command sets the instrument's manufacturer string to "Keysight Technologies" which is the default manufacturer setting.*

### Query

**SYSTem:PERSonA:MANuufacturer:DEFault?**  
The query returns the default manufacturer string.

### Query Example

**SYST:PERS:MAN:DEF?**      *Queries the default manufacturer string.*



## SYSTEM:PRESet <character\_data>

This command presets the power meter to values appropriate for measuring the communications format specified by <character\_data>. The power meter is preset to default values if no value or the value DEFault is supplied.

### NOTE

DEFault settings apply to both \*RST and to SYSTEM:PRESet DEFault unless stated otherwise.

For further information on preset configurations, refer to [Table 12-1](#) through to [Table 12-49](#).

Command results differ according to the sensor(s) connected to the power meter:

- If connected to a power meter, a P-Series sensor are connected to one channel, and another model sensor is connected to the other channel, the channel connected to the P-Series sensor is set up according to the <character\_data> value and the other channel is set to DEFault values.
- If two P-Series sensors are connected to power meter, both channels are set to the same values except for bandwidth which is set to an appropriate value for each sensor.

### Primary and Secondary Channels

P-Series modular power meter channels are defined as either primary or secondary. The primary channel is always the trigger leader and primary channel measurements occupy a greater share of the display space than secondary channel measurements.

- If a power meter has a P-Series sensor connected, the P-Series sensor channel is the primary channel. In such cases the primary channel could be either Channel A or Channel B. The other model's channel is the secondary channel.
- If a power meter has two, P-Series sensors, connected to it, the primary channel is always Channel A and the secondary channel is Channel B.

## Syntax

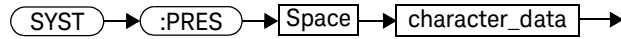

## Parameters

Item	Description	Range of Values
character_data	A communications format which determines the preset values. Refer to <a href="#">Table 12-1</a> through to <a href="#">Table 12-49</a> for the preset values for each format.	DEFault GSM900 EDGE NADC BLUetooth CDMAone WCDMA CDMA2000 IDEN MCPa RADar WL802DOT11A WL802DOT11B XEVDO XEVDV TDSCdma DVB HIPERLAN2

## Example

**SYST:PRES DEF**

*This command presets the power meter with default values. The same default values are set when the parameter is omitted.*

## Error messages

- If a non-E-Series power sensor is connected, the command can be used to set the power meter to Default settings. Attempts to set the power meter to any of the other settings result in error -241 “Hardware missing” occurring.

## Preset Values

## DEFAult

Table 12-1 shows the power meter presets when <character\_data> is set to DEFAult or omitted. Values are shown for all SCPI commands:

**Table 12-1** DEFAult: Power meter presets

Command	Setting	Comments
CALC[1] 2 3 4:FEED[1] 2	<b>"POW:AVER"</b>	Select average measurement type
CALC[1] 2 3 4:GAIN[:MAGN]	<b>0.000 dB</b>	Display offset value
CALC[1] 2 3 4:GAIN:STAT	<b>OFF</b>	Display offset disabled
CALC[1] 2 3 4:LIM:CLE:AUTO	<b>ON</b>	Clear limit data at INIT
CALC[1] 2 3 4:LIM:LOW[:DATA]	<b>-90 dBm</b>	Lower limit
CALC[1] 2 3 4:LIM:STAT	<b>OFF</b>	Window limits checking disabled
CALC[1] 2 3 4:LIM:UPP[:DATA]	<b>+90 dBm</b>	
CALC[1] 2 3 4:MATH[:EXPR]	<b>Upper - Channel A Lower - Channel B</b>	Math expression
CALC[1] 2 3 4:REL[:MAGN]:AUTO	<b>OFF</b>	Reference value disabled
CALC[1] 2 3 4:REL:STAT	<b>OFF</b>	Relative offset disabled
CAL[1] 2:ECON:STAT	<b>OFF</b>	TTL zero/calibration inputs disabled
CAL[1] 2:RCAL	<b>not affected</b>	zero/cal lockout
CAL[1] 2:RCF	<b>100.0 %</b>	Reference calibration factor
DISP:CONT	<b>not affected</b>	Display contrast
DISP:ENAB	<b>ON</b>	Display enabled
DISP:SCR:FORM	<b>WIND</b>	Display format set to windowed
DISP[:WIND[1] 2]:ANAL:LOW	<b>-70 dBm</b>	Lower scale limit
DISP[:WIND[1] 2]:ANAL:UPP	<b>20 dBm</b>	Upper scale limit
DISP[:WIND[1] 2]:FORM	<b>Upper - digital Lower - digital</b>	Display format

**Table 12-1**      DEFAult: Power meter presets (continued)

Command	Setting	Comments
DISP[:WIND[1] 2]:MET:LOW	<b>-70.000 dBm</b>	Analog meter lower limit
DISP[:WIND[1] 2]:MET:UPP	<b>+20.000 dBm</b>	Analog meter upper limit
DISP[:WIND[1] 2][:NUM[1] 2]:RES	<b>3</b>	Window resolution
DISP[:WIND[1] 2]:SEL[1] 2	<b>upper window</b>	Window selected
DISP[:WIND[1] 2][:STAT]	<b>ON</b>	Both windows enabled on display
SENSe[1] 2:TRAC:LIM:UPP	<b>DEF</b>	Maximum power
SENSe[1] 2:TRAC:LIM:LOW	<b>DEF</b>	Minimum power
FORM[:READ]:BORD	<b>normal</b>	Binary order
FORM[:READ][:DATA]	<b>ascii</b>	Data format
INIT[1] 2:CONT	<b>*RST: OFF SYS:PRES ON</b>	Power meter in idle state Power meter in wait for trigger state
MEM:TABL:SEL	<b>not affected</b>	Active sensor calibration table
OUTP:REC[1] 2:FEED	<b>not affected</b>	Previous measurement
OUTP:REC[1] 2:LIM:LOW	<b>-150 dBm</b>	Minimum scaling value
OUTP:REC[1] 2:LIM:UPP	<b>20 dBm</b>	Maximum scaling value
OUTP:ROSC:STAT	<b>OFF</b>	50 MHz reference disabled
OUTP:TRIG:STAT	<b>OFF</b>	Trigger output signal disabled
[SENS[1]] SENS2:AVER:COUN	<b>4</b>	Filter length
[SENS[1]] SENS2:AVER:COUN:AUTO	<b>ON</b>	Auto-filtering enabled
[SENS[1]] SENS2:AVER:SDET	<b>1</b>	Step detection enabled
[SENS[1]] SENS2:AVER[:STAT]	<b>ON</b>	Averaging enabled
[SENS[1]] SENS2:AVER2:COUN	<b>4</b>	Video average length
[SENS[1]] SENS2:AVER2[:STAT]	<b>ON</b>	Video averaging enabled
[SENS[1]] SENS2:BAND BWID:VID	<b>OFF</b>	Sensor video bandwidth set to off
[SENS[1]] SENS2:CORR:CFAC  GAIN[1][:INPut][:MAGNitude]	<b>100.0 %</b>	Calibration factor
[SENS[1]] SENS2:CORR:CSET[1] CSET2[:SEL]	<b>not affected</b>	Selected sensor calibration table

**Table 12-1** DEFault: Power meter presets (continued)

Command	Setting	Comments
[SENS[1]] SENS2:CORR:CSET[1] CSET2:STAT	<b>not affected</b>	Sensor calibration table disabled
[SENS[1]] SENS2:CORR:DCYC GAIN3[:INP][:MAGN]	<b>1.000 %</b>	Duty cycle factor
[SENS[1]] SENS2:CORR:DCYC GAIN3:STAT	<b>OFF</b>	Duty cycle correction disabled
[SENS[1]] SENS2:CORR:FDOF GAIN4[:INP][:MAGN]	<b>not affected</b>	Return frequency dependent offset
[SENS[1]] SENS2:CORR:GAIN2:STAT	<b>OFF</b>	Channel offset disabled
[SENS[1]] SENS2:CORR:GAIN2:STAT[:INPut][:MAGNitude]	<b>0.0 dB</b>	Enter channel offset value
[SENS[1]] SENS2:DET:FUNC	<b>NORM</b>	Measurement mode
[SENS[1]] SENS2:FREQ[:CW]:FIX]	<b>+50.000 MHz</b>	Frequency setting
[SENSe[1]] SENS2:MRAT	<b>NORM</b>	Measurement speed
[SENS[1]] SENS2:POW:AC:RANG	<b>upper</b>	Upper range selected
[SENS[1]] SENS2:POW:AC:RANG:AUTO	<b>ON</b>	Auto-ranging selected
[SENS[1]] SENS2:SPE	<b>20 readings/second</b>	Speed
[SENS[1]] SENS2:SWE[1] 2 3 4:OFFS:TIME	<b>0</b>	Set delay
[SENS[1]] SENS2:SWE[1] 2 3 4:TIME	<b>Gate 1: 100 <math>\mu</math>s Other gates: 0 sec</b>	Set time gated period
[SENS[1]] SENS2:TRACe:OFFSet:TIME	<b>0</b>	Delay
[SENS[1]] SENS2:TRACe:TIME	<b>100 <math>\mu</math>s</b>	Duration of trace
[SENS[1]] SENS2:V2P	<b>ATYP</b>	Select linearity correction
TRAC[1] 2:STAT	<b>OFF</b>	Disable trace capture
TRAC[1] 2:UNIT	<b>dBm</b>	Trace units
TRIG[1] 2:DEL:AUTO	<b>ON</b>	Insert settling time delay
TRIG[:SEQ]:DEL	<b>0</b>	Delay between recognition of trigger event and start of a measurement
TRIG[:SEQ]:HOLD	<b>1 <math>\mu</math>s</b>	Trigger holdoff
TRIG[:SEQ]:HYST	<b>0 dB</b>	Fall/rise below/above TRIG:LEV

**Table 12-1** DEFault: Power meter presets (continued)

Command	Setting	Comments
TRIG[:SEQ]:LEV	<b>0 dB</b>	Power level
TRIG[:SEQ]:LEV:AUTO	<b>ON</b>	Enable automatic setting of trigger level
TRIG[:SEQ]:SLOP	<b>POS</b>	Trigger event recognized on rising edge
TRIG[:SEQ[1] 2]:COUN	<b>1</b>	Trigger events for measurement cycle
TRIG[:SEQ[1] 2]:DEL:AUTO	<b>ON</b>	Enable settling time delay
TRIG[:SEQ[1] 2]:SOUR	<b>IMM</b>	Trigger source set up
UNIT:POW	<b>dBm</b>	Power units
UNIT:POW:RAT	<b>dB</b>	Ratio units

## GSM900

Table 12-2 shows the power meter presets when `<character_data>` is set to GSM900.

The GSM900 set-up provides the following:

- Average power measurement in one GSM timeslot
- Trace display showing “on” timeslot

A GSM900 measurement is started by detecting the rising edge of a GSM RF burst—for example the burst emitted by a GSM mobile—using the internal RF level trigger. The trigger level is set to  $-20$  dBm. Time-gating is used to measure the average power in the useful part of a GSM burst.

Commands not listed are preset according to their **Default** values (for further information refer to Table 12-1).

**Table 12-2** GSM900: Power meter presets

Command	Setting	Comments
<i>Frequency</i>		
[SENS[1]] SENS2:FREQ[:CW]:FIX]	<b>+900.000 MHz</b>	Frequency setting
<i>Sensor measurement mode</i>		
[SENS[1]] SENS2:DET:FUNC	<b>NORM</b>	Measurement mode
<i>Sensor video bandwidth setup</i>		
[SENS[1]] SENS2:BAND BWID:VID	<b>N1921/2A: LOW</b>	Sensor video bandwidth
<i>Gate Setup</i>		
[SENS[1]] SENS2:SWE[1] 2 3 4:OFF:TIME	<b>Gate 1: 20 <math>\mu</math>s Gates 2 - 4: 0</b>	Delay between trigger point and time gated period.
[SENS[1]] SENS2:SWE[1] 2 3 4:TIME	<b>Gate 1: 520 <math>\mu</math>s Gates 2 - 4: 0</b>	Length of time gated period for time gated measurements.
<i>Trigger setup</i>		
TRIG[:SEQ[1] 2]:SOUR	<b>INT1</b>	Trigger source set up and acquisition mode continuous triggering
INIT:CONT	<b>ON</b>	
TRIG[:SEQ]:LEV:AUTO	<b>OFF</b>	Disable automatic setting of the trigger level



**Table 12-2** GSM900: Power meter presets (continued)

Command	Setting	Comments
TRIG[:SEQ]:LEV	<b>-15 dBm</b>	Power level
TRIG[:SEQ]:SLOP	<b>POS</b>	Trigger event recognized on the rising edge of a signal
TRIG[:SEQ]:DEL	<b>20 <math>\mu</math>s</b>	Delay between recognition of trigger event and start of a measurement
TRIG[:SEQ]:HOLD	<b>4275 <math>\mu</math>s</b>	Trigger holdoff
<i>Range</i>		
[SENS[1]] SENS2:POW:AC:RANG:AUTO	<b>OFF</b>	Auto range off
[sens[1]] SENS2:POWER:AC:RANG	<b>UPPER</b>	Range set to upper
<i>Step detection</i>		
[SENSe[1]] SENS2:AVER:SDET	<b>1</b>	Step detection enabled
<i>Trace setup</i>		
SENSe[1] 2:TRAC:LIM:UPP	<b>+20 dBm</b>	Maximum power
SENSe[1] 2:TRAC:LIM:LOW	<b>-35 dBm</b>	Minimum power
[SENS[1]] SENS2:TRAC:OFFS:TIME <numeric_value>	<b>-40 <math>\mu</math>s</b>	Delay between delayed trigger point and the start of the trace
[SENS[1]] SENS2:TRAC:TIME <numeric_value>	<b>700 <math>\mu</math>s</b>	Length of the trace

**NOTE**

The Range setting in [Table 12-2](#) is only applicable for E-Series power sensor.

**Table 12-3** GSM900: Power meter presets: Window/Measurement settings

Function	Setting	
	Single Channel	Dual Channel
<i>Display setup</i>		
Upper window	Channel A trace	Primary channel <sup>[a]</sup> trace
Lower window	LU single numeric	See <a href="#">Table 12-4</a>
<i>Window/measurement setup</i>		
<i>Upper window/upper measurement (UU)</i>		
Feed	N/A	N/A
Measurement	N/A	N/A
<i>Upper window/lower measurement (UL)</i>		
Feed	N/A	N/A
Measurement	N/A	N/A
<i>Lower window/upper measurement (LU)</i>		
Feed	Gate 1 Channel A	Gate 1 primary channel <sup>[a]</sup>
Measurement	Avg	Avg
<i>Lower window/lower measurement (LL)</i>		
Feed	DEF	See <a href="#">Table 12-4</a>
Measurement	DEF	See <a href="#">Table 12-4</a>

[a] For further information refer to "Primary and Secondary Channels" on page 473.

**Table 12-4** GSM900: Power meter presets for secondary channel sensors

Function	Secondary Channel Sensor		
	No Sensor	Non P-Series	P-Series
<i>Display setup</i>			
Lower window	LU single numeric	Dual numeric	Dual numeric

**Table 12-4** GSM900: Power meter presets for secondary channel sensors (continued)

Function	Secondary Channel Sensor		
	No Sensor	Non P-Series	P-Series
<i>Lower window/lower measurement (LL)</i>			
Feed	DEF	Secondary channel <sup>[a]</sup>	Gate1 secondary channel <sup>[a]</sup> (Channel B)
Measurement	DEF	Avg	Avg

[a] For further information refer to “Primary and Secondary Channels” on page 473.

### EDGE

EDGE (Enhanced Data for Global Evolution or Enhanced Data for GSM Evolution) is an enhancement of the GSM standard. Whereas the GSM modulation scheme is GMSK which has constant amplitude, the EDGE modulation scheme is 8PSK which has variable amplitude.

The EDGE set-up provides:

- Average power measurement in an EDGE burst.
- Peak-to-average ratio in an EDGE burst.
- A trace display of the burst profile

An EDGE measurement is started by detecting the rising edge of the EDGE RF burst—for example the burst emitted by a mobile—using the internal RF level trigger. The internal level trigger is set to -20 dBm. Trigger level hysteresis is used to prevent the power meter re-triggering on the varying power levels within the EDGE burst. Time-gating is used to measure the average power and the peak-to-average ratio in the useful part of the RF burst.

The following table shows the power meter presets when `<character_data>` is set to EDGE. Commands not listed are preset according to their **DEFault** values (for further information refer to [Table 12-1](#)).

**Table 12-5** EDGE: Power meter presets

Command	Setting	Comments
<i>Frequency</i>		
[SENS[1]]   SENS2:FREQ[:CW] :FIX]	<b>+900.000 MHz</b>	Frequency setting
<i>Sensor measurement mode</i>		
[SENS[1]]   SENS2:DET:FUNC	<b>NORM</b>	Measurement mode
<i>Sensor video bandwidth setup</i>		
[SENS[1]]   SENS2:BAND BWID:VID	<b>N1921/2A:LOW</b>	Sensor video bandwidth
<i>Gate Setup</i>		
[SENS[1]]   SENS2:SWE[1]   2   3   4:OFF:TIME	<b>Gate 1: 20 <math>\mu</math>s Gates 2 - 4: 0</b>	Delay between trigger point and time gated period.
[SENS[1]]   SENS2:SWE[1]   2   3   4:TIME	<b>Gate 1: 520 <math>\mu</math>s Gates 2 - 4: 0</b>	Length of time gated period for time gated measurements.
<i>Trigger setup</i>		
TRIG[:SEQ[1]   2]:SOUR	<b>INT1</b>	Trigger source set up and acquisition mode
INIT:CONT	<b>ON</b>	continuous triggering
TRIG[:SEQ]:LEV:AUTO	<b>OFF</b>	Disable automatic setting of the trigger level
TRIG[:SEQ]:LEV	<b>-15 dBm</b>	Power level
TRIG[:SEQ]:SLOP	<b>POS</b>	Trigger event recognized on the rising edge of a signal
TRIG[:SEQ]:DEL	<b>0 s</b>	Delay between recognition of trigger event and start of a measurement
TRIG[:SEQ]:HOLD	<b>4275 <math>\mu</math>s</b>	Trigger holdoff
TRIG[:SEQ]:HYST	<b>3 dB</b>	Hysteresis
<i>Range</i>		
[SENS[1]]   SENS2:POW:AC:RANG:AUTO	<b>OFF</b>	Auto range off
[SENS[1]]   SENS2:POW:AC:RANG	<b>UPPER</b>	Range set to upper

**Table 12-5** EDGE: Power meter presets (continued)

Command	Setting	Comments
<i>Averaging</i>		
[SENSe[1]] SENSe2:AVeR[:STATe]	<b>ON</b>	Averaging On
[SENSe[1]] SENSe2:AVeR:COUN	<b>64</b>	Averaging set to 64
<i>Step detection</i>		
[SENSe[1]] SENS2:AVeR:SDET	<b>1</b>	Step detection enabled
<i>Trace setup</i>		
SENSe[1] 2:TRAC:LIM:UPP	<b>+20 dBm</b>	Maximum power
SENSe[1] 2:TRAC:LIM:LOW	<b>-35 dBm</b>	Minimum power
[SENS[1]] SENS2:TRAC:OFFS:TIME <numeric_value>	<b>-40 <math>\mu</math>s</b>	Delay between delayed trigger point and the start of the trace
[SENS[1]] SENS2:TRAC:TIME <numeric_value>	<b>700 <math>\mu</math>s</b>	Length of the trace

**NOTE**

The Range setting in [Table 12-5](#) is only applicable for E-Series power sensor.

**Table 12-6** EDGE: Power meter presets: Window/Measurement settings

Function	Setting	
	Single Channel	Dual Channel
<i>Display setup</i>		
Upper window	Channel A trace	Primary channel <sup>[a]</sup> trace
Lower window	Dual numeric	See <a href="#">Table 12-7</a>
<i>Window/measurement setup</i>		
<i>Upper window/upper measurement (UU)</i>		
Feed	N/A	N/A

**Table 12-6** EDGE: Power meter presets: Window/Measurement settings (continued)

Function	Setting	
	Single Channel	Dual Channel
Measurement	N/A	N/A
<i>Upper window/lower measurement (UL)</i>		
Feed	N/A	N/A
Measurement	N/A	N/A
<i>Lower window/upper measurement (LU)</i>		
Feed	Gate 1 Channel A	Gate 1 primary channel <sup>[a]</sup>
Measurement	Avg	Avg
<i>Lower window/lower measurement (LL)</i>		
Feed	Gate 1 Channel A	See Table 12-7
Measurement	Pk-to-Avg	See Table 12-7

[a] For further information refer to "Primary and Secondary Channels" on page 473.

**Table 12-7** EDGE: Power meter presets for secondary channel sensors

Function	Secondary Channel Sensor		
	No Sensor	Non P-Series Sensor	P-Series Sensor
<i>Display setup</i>			
Lower window	Dual numeric	Dual numeric	Dual numeric
<i>Lower window/lower measurement (LL)</i>			
Feed	Gate 1 primary channel*	Secondary channel <sup>[a]</sup>	Gate1 secondary channel <sup>[a]</sup> (Channel B)
Measurement	Pk-to-Avg	Avg	Avg

[a] For further information refer to "Primary and Secondary Channels" on page 473.

## CDMAone

The cdmaOne set-up provides:

- Average power in an IS-95 cdmaOne signal (bandwidth is less than 1.5 MHz).
- Peak power and peak-to-average ratio of the signal over a defined, statistically valid number of samples. The reading is continuously refreshed. This gives an indication of how cdmaOne channel loading affects peak power and power distribution.

The measurement is a continuously gated measurement on a cdmaOne signal. Its aim is to measure the peak and average power corresponding to a <0.01 % probability that there are no peaks above the returned peak reading. Time gating is therefore set to 10 ms, corresponding to 200000 samples. Triggering is set to occur continuously internally to the meter. The internal trigger is set to AutoLevel. A reading over the 10ms period is returned and the reading is then re-initiated for the next 10ms period. In this way the reading always relates to a position beyond 0.01 % on the CCDF and will refresh to track any signal or DUT changes.

The following table shows the power meter presets when <character\_data> is set to CDMAone. Commands not listed are preset according to their **DEFault** values (for further information refer to [Table 12-1](#)):

**Table 12-8** CDMAone: Power meter presets

Command	Setting	Comments
<i>Frequency</i>		
[SENS[1]] SENS2:FREQ[:CW]:FIX]	<b>+850.000 MHz</b>	Frequency setting
<i>Sensor measurement mode</i>		
[SENS[1]] SENS2:DET:FUNC	<b>NORM</b>	Measurement mode
<i>Sensor video bandwidth setup</i>		
[SENS[1]] SENS2:BAND BWID:VID	<b>N1921/2A: OFF</b>	Sensor video bandwidth
<i>Gate Setup</i>		
[SENS[1]] SENS2:SWE[1] 2 3 4:OFF:TIME	<b>Gate 1: 0 s Gates 2 - 4: 0</b>	Delay between trigger point and time gated period.
[SENS[1]] SENS2:SWE[1] 2 3 4:TIME	<b>Gate 1: 10 ms Gates 2 - 4: 0</b>	Length of time gated period for time gated measurements.

**Table 12-8** CDMAone: Power meter presets (continued)

Command	Setting	Comments
<i>Trigger setup</i>		
TRIG[:SEQ[1] 2]:SOUR	<b>INT1</b>	Trigger source set up and acquisition mode continuous triggering
INIT:CONT	<b>ON</b>	
TRIG[:SEQ]:LEV:AUTO	<b>ON</b>	Enable automatic setting of the trigger level
TRIG[:SEQ]:LEV	<b>AUTO</b>	Automatic Power level
TRIG[:SEQ]:SLOP	<b>POS</b>	Trigger event recognized on the rising edge of a signal
TRIG[:SEQ]:DEL	<b>0 s</b>	Delay between recognition of trigger event and start of a measurement
TRIG[:SEQ]:HOLD	<b>MIN</b>	Trigger holdoff
<i>Range<sup>[a]</sup></i>		
[SENS[1]] SENS2:POW:AC:RANG:AUTO	<b>OFF</b>	Auto range off
[SENS[1]] SENS2:POW:AC:RANG	<b>UPPER</b>	Range set to upper
<i>Step detection</i>		
[SENSe[1]] SENS2:AVER:SDET	<b>0</b>	Step detection disabled

[a] The Range setting in [Table 12-8](#) is only applicable for E-Series power sensor.



**Table 12-9** CDMAone: Power meter presets: Window/Measurement settings

Function	Setting	
	Single Channel	Dual Channel
<i>Display setup</i>		
Upper window	UU single numeric	See <a href="#">Table 12-10</a>
Lower window	Dual numeric	See <a href="#">Table 12-10</a>
<i>Window/measurement setup</i>		
<i>Upper window/upper measurement (UU)</i>		
Feed	Gate 1 Channel A	Gate 1 primary channel <sup>[a]</sup>
Measurement	Avg	Avg
<i>Upper window/lower measurement (UL)</i>		
Feed	DEF	See <a href="#">Table 12-10</a>
Measurement	DEF	See <a href="#">Table 12-10</a>
<i>Lower window/upper measurement (LU)</i>		
Feed	Gate 1 Channel A	See <a href="#">Table 12-10</a>
Measurement	Peak	See <a href="#">Table 12-10</a>
<i>Lower window/lower measurement (LL)</i>		
Feed	Gate 1 Channel A	See <a href="#">Table 12-10</a>
Measurement	Pk-to-Avg	See <a href="#">Table 12-10</a>

[a] For further information refer to ["Primary and Secondary Channels"](#) on page 473.

**Table 12-10** CDMAone: Power meter presets for secondary channel sensors

Function	Secondary Channel Sensor		
	No Sensor	Non P-Series Sensor	P-Series Sensor
<i>Display setup</i>			
Upper window	UU single numeric	Dual numeric	Dual numeric
Lower window	Dual numeric	Dual numeric	Dual numeric
<i>Upper window/lower measurement (UL)</i>			
Feed	DEF	Gate 1 primary channel <sup>[a]</sup>	Gate 1 primary channel <sup>[a]</sup> (Channel A)
Measurement	DEF	Peak	Peak
<i>Lower window/upper measurement (LU)</i>			
Feed	Gate 1 primary channel <sup>[a]</sup>	Gate 1 primary channel <sup>[a]</sup>	Gate 1 secondary channel <sup>[a]</sup> (Channel B)
Measurement	Peak	Pk-to-Avg	Avg
<i>Lower window/lower measurement (LL)</i>			
Feed	Gate 1 primary channel <sup>[a]</sup>	Secondary channel <sup>[a]</sup>	Gate 1 secondary channel <sup>[a]</sup> (Channel B)
Measurement	Pk-to-Avg	Avg	Pk-to-Avg

[a] For further information refer to "Primary and Secondary Channels" on page 473.

## CDMA2000

The cdma2000 set-up provides:

- Average power in a cdma2000 signal (bandwidth <=5 MHz).
- Peak power and peak-to-average ratio of the signal over a defined, statistically valid number of samples. The reading is continuously refreshed. This indicates how cdma2000 channel loading affects peak power and power distribution.

The measurement is a continuously gated measurement on a 3 GPP cdma2000 signal. Its aim is to measure the peak and average power corresponding to a <0.01 % probability that there are no peaks above the returned peak reading. Time gating is set to 10 ms, corresponding to 200,000 samples. Triggering is set to occur continuously internally to the meter. The internal trigger is set to AutoLevel. A reading over the 10 ms period is returned, then the reading is re-initiated for the next 10ms period. In this way the reading always relates to a position beyond 0.01 % on the CCDF and will refresh to track any signal or DUT changes.

The following table shows the power meter presets when <character\_data> is set to **CDMA2000**. Commands not listed are preset according to their **DEFault** values (for further information refer to [Table 12-1](#)):

**Table 12-11** cdma2000: Power meter presets

Command	Setting	Comments
<i>Frequency</i>		
[SENS[1]] SENS2:FREQ[:CW]:FIX]	<b>+1900.000 MHz</b>	Frequency setting
<i>Sensor measurement mode</i>		
[SENS[1]] SENS2:DET:FUNC	<b>NORM</b>	Measurement mode
<i>Sensor video bandwidth setup</i>		
[SENS[1]] SENS2:BAND BWID:VID	<b>N1921/2A: OFF</b>	Sensor video bandwidth
<i>Gate Setup</i>		
[SENS[1]] SENS2:SWE[1] 2 3 4:OFF:TIME	<b>Gate 1: 0 s Gates 2 - 4: 0</b>	Delay between trigger point and time gated period.
[SENS[1]] SENS2:SWE[1] 2 3 4:TIME	<b>Gate 1: 10 ms Gates 2 - 4: 0</b>	Length of time gated period for time gated measurements.
<i>Trigger setup</i>		

**Table 12-11** cdma2000: Power meter presets (continued)

Command	Setting	Comments
TRIG[:SEQ[1] 2]:SOUR	<b>INT1</b>	Trigger source set up and acquisition mode continuous triggering
INIT:CONT	<b>ON</b>	
TRIG[:SEQ]:LEV:AUTO	<b>ON</b>	Enable automatic setting of the trigger level
TRIG[:SEQ]:LEV	<b>AUTO</b>	Automatic Power level
TRIG[:SEQ]:SLOP	<b>POS</b>	Trigger event recognized on the rising edge of a signal
TRIG[:SEQ]:DEL	<b>0 s</b>	Delay between recognition of trigger event and start of a measurement
TRIG[:SEQ]:HOLD	<b>MIN</b>	Trigger holdoff
<i>Range<sup>[a]</sup></i>		
[SENS[1]] SENS2:POW:AC:RANG:AUTO	<b>OFF</b>	Auto range off
[SENS[1]] SENS2:POW:AC:RANG	<b>UPPER</b>	Range set to upper
<i>Step detection</i>		
[SENSe[1]] SENS2:AVER:SDET	<b>0</b>	Step detection disabled

[a] The Range setting in [Table 12-11](#) is only applicable for E-Series power sensor.

**Table 12-12** cdma2000: Power meter presets: Window/Measurement settings

Function	Setting	
	Single Channel	Dual Channel
<i>Display setup</i>		
Upper window	UU single numeric	UU single numeric
Lower window	Dual numeric	See <a href="#">Table 12-13</a>
<i>Window/measurement setup</i>		
<i>Upper window/upper measurement (UU)</i>		

**Table 12-12** cdma2000: Power meter presets: Window/Measurement settings (continued)

Function	Setting	
	Single Channel	Dual Channel
Feed	Gate 1 Channel A	Gate 1 primary channel <sup>[a]</sup>
Measurement	Avg	Avg
<i>Upper window/lower measurement (UL)</i>		
Feed	DEF	DEF
Measurement	DEF	DEF
<i>Lower window/upper measurement (LU)</i>		
Feed	Gate 1 Channel A	Gate 1 primary channel <sup>[a]</sup>
Measurement	Peak	Peak
<i>Lower window/lower measurement (LL)</i>		
Feed	Gate 1 Channel A	See <a href="#">Table 12-13</a>
Measurement	Pk-to-Avg	See <a href="#">Table 12-13</a>

[a] For further information refer to [“Primary and Secondary Channels”](#) on page 473.

**Table 12-13** cdma2000: Power meter presets for secondary channel sensors

Function	Secondary Channel Sensor		
	No Sensor	Non P-series Sensor	P-seriesSensor
<i>Display setup</i>			
Upper window	UU single numeric	Dual numeric	Dual numeric
Lower window	Dual numeric	Dual numeric	Dual numeric
<i>Upper window/lower measurement (UL)</i>			
Feed	DEF	Gate 1 primary channel <sup>[a]</sup>	Gate 1 primary channel <sup>[a]</sup> (channel A)
Measurement	DEF	Peak	Peak
<i>Lower window/upper measurement (LU)</i>			
Feed	Gate 1 primary channel <sup>[a]</sup>	Gate 1 primary channel <sup>[a]</sup>	Gate1 secondary channel <sup>[a]</sup> (channel B)
Measurement	Peak	Pk-to-Avg	Avg
<i>Lower window/lower measurement (LL)</i>			
Feed	Gate 1 primary channel <sup>[a]</sup>	Secondary channel <sup>[a]</sup>	Gate1 secondary channel <sup>[a]</sup> (channel B)
Measurement	Pk-to-Avg	Avg	Pk-to-Avg

[a] For further information refer to "Primary and Secondary Channels" on page 473.

## W-CDMA

The W-CDMA set-up provides:

- Average power in a W-CDMA signal (bandwidth  $\leq 5$  MHz)
- Peak power and peak-to-average ratio of the signal over a defined, statistically valid number of samples. The reading is continuously refreshed. This indicates how W-CDMA channel loading affects peak power and power distribution.

The measurement is a continuously gated measurement on a 3GPP W-CDMA signal. Its aim is to measure the peak and average power corresponding to a  $<0.01$  % probability that there are no peaks above the returned peak reading. Time gating is set to 10 ms, corresponding to 200000 samples. Triggering is set to occur continuously internally to the meter. The internal trigger is set to AutoLevel. A reading over the 10 ms period is returned then re-initiated for the next 10 ms period. In this way the reading always relates to a position beyond 0.01 % on the CCDF and will refresh to track any signal or DUT changes.

The following table shows the power meter presets when `<character_data>` is set to `WCDMA`. Commands not listed are preset according to their `DEFault` values (for further information refer to [Table 12-1](#))

**Table 12-14** W-CDMA: Power meter presets

Command	Setting	Comments
<i>Frequency</i>		
[SENS[1]] SENS2:FREQ[:CW]:FIX]	<b>+1900.000 MHz</b>	Frequency setting
<i>Sensor measurement mode</i>		
[SENS[1]] SENS2:DET:FUNC	<b>NORM</b>	Measurement mode
<i>Sensor video bandwidth setup</i>		
[SENS[1]] SENS2:BAND BWID:VID	<b>N1921/2A: OFF</b>	Sensor video bandwidth
<i>Gate Setup</i>		
[SENS[1]] SENS2:SWE[1] 2 3 4:OFF:TIME	<b>Gate 1: 0 s Gates 2 - 4: 0</b>	Delay between trigger point and time gated period.
[SENS[1]] SENS2:SWE[1] 2 3 4:TIME	<b>Gate 1: 10 ms Gates 2 - 4: 0</b>	Length of time gated period for time gated measurements.
<i>Trigger setup</i>		

**Table 12-14** W-CDMA: Power meter presets (continued)

Command	Setting	Comments
TRIG[:SEQ[1] 2]:SOUR	<b>INT1</b>	Trigger source set up and acquisition mode continuous triggering
INIT:CONT	<b>ON</b>	
TRIG[:SEQ]:LEV:AUTO	<b>ON</b>	Enable automatic setting of the trigger level
TRIG[:SEQ]:LEV	<b>AUTO</b>	Automatic Power level
TRIG[:SEQ]:SLOP	<b>POS</b>	Trigger event recognized on the rising edge of a signal
TRIG[:SEQ]:DEL	<b>0 s</b>	Delay between recognition of trigger event and start of a measurement
TRIG[:SEQ]:HOLD	<b>1 <math>\mu</math>s</b>	Trigger holdoff
<i>Range<sup>[a]</sup></i>		
[SENS[1]] SENS2:POW:AC:RANG:AUTO	<b>OFF</b>	Auto range off
[SENS[1]] SENS2:POW:AC:RANG	<b>UPPER</b>	Range set to upper
<i>Step detection</i>		
[SENSe[1]] SENS2:AVER:SDET	<b>0</b>	Step detection disabled

[a] The Range setting in [Table 12-14](#) is only applicable for E-Series power sensor.

**Table 12-15** W-CDMA: Power meter presets: Window/Measurement settings

Function	Setting	
	Single Channel	Dual Channel
<i>Display setup</i>		
Upper window	UU single numeric	See <a href="#">Table 12-16</a>
Lower window	Dual numeric	See <a href="#">Table 12-16</a>
<i>Window/measurement setup</i>		
<i>Upper window/upper measurement (UU)</i>		
Feed	Gate 1 Channel A	Gate 1 primary channel <sup>[a]</sup>



**Table 12-15** W-CDMA: Power meter presets: Window/Measurement settings (continued)

Function	Setting	
	Single Channel	Dual Channel
Measurement	Avg	Avg
<i>Upper window/lower measurement (UL)</i>		
Feed	DEF	See <a href="#">Table 12-16</a>
Measurement	DEF	See <a href="#">Table 12-16</a>
<i>Lower window/upper measurement (LU)</i>		
Feed	Gate 1 Channel A	See <a href="#">Table 12-16</a>
Measurement	Peak	See <a href="#">Table 12-16</a>
<i>Lower window/lower measurement (LL)</i>		
Feed	Gate 1 Channel A	See <a href="#">Table 12-16</a>
Measurement	Pk-to-Avg	See <a href="#">Table 12-16</a>

[a] For further information refer to ["Primary and Secondary Channels"](#) on page 473.

**Table 12-16** W-CDMA: Power meter presets for secondary channel sensors

Function	Secondary Channel Sensor		
	No Sensor	Non P-Series Sensor	P-Series Sensor
<i>Display setup</i>			
Upper window	UU single numeric	Dual numeric	Dual numeric
Lower window	Dual numeric	Dual numeric	Dual numeric
<i>Upper window/lower measurement (UL)</i>			
Feed	DEF	Gate 1 primary channel <sup>[a]</sup>	Gate 1 primary channel <sup>[a]</sup> (Channel A)
Measurement	DEF	Peak	Peak
<i>Lower window/upper measurement (LU)</i>			
Feed	Gate 1 primary channel <sup>[a]</sup>	Gate 1 primary channel <sup>[a]</sup>	Gate 1 secondary channel <sup>[a]</sup> (Channel B)
Measurement	Peak	Pk-to-Avg	Avg
<i>Lower window/lower measurement (LL)</i>			
Feed	Gate 1 primary channel <sup>[a]</sup>	Secondary channel <sup>[a]</sup>	Gate 1 secondary channel <sup>[a]</sup> (Channel B)
Measurement	Pk-to-Avg	Avg	Pk-to-Avg

[a] For further information refer to "Primary and Secondary Channels" on page 473.

## BLUetooth

The Bluetooth set-up provides:

- Average power in a Bluetooth DH1 data burst.
- Peak power in the same burst
- Display of RF pulse in one timeslot

The measurement is started by detecting the Bluetooth RF burst using the internal RF level trigger. The internal trigger is set to  $-20$  dBm. Time-gating is used to measure the peak and average power in a single Bluetooth DHI data burst which lasts for 366  $\mu$ s. The DHI burst does not occupy a full Bluetooth timeslot, which lasts for 625  $\mu$ s.

The following table shows the power meter presets when `<character_data>` is set to **BLUetooth**. Commands not listed are preset according to their **DEFault** values (for further information refer to [Table 12-1](#)):

**Table 12-17** BLUetooth: Power meter presets

Command	Setting	Comments
<i>Frequency</i>		
[SENS[1]] SENS2:FREQ[:CW]:FIX]	<b>+2400.000 MHz</b>	Frequency setting
<i>Sensor measurement mode</i>		
[SENS[1]] SENS2:DET:FUNC	<b>NORM</b>	Measurement mode
<i>Sensor video bandwidth setup</i>		
[SENS[1]] SENS2:BAND BWID:VID	<b>N1921/2A: OFF</b>	Sensor video bandwidth
<i>Gate Setup</i>		
[SENS[1]] SENS2:SWE[1] 2 3 4:OFF:TIME	<b>Gate 1: 0.2 <math>\mu</math>s Gates 2 - 4: 0</b>	Delay between trigger point and time gated period.
[SENS[1]] SENS2:SWE[1] 2 3 4:TIME	<b>Gate 1: 366 <math>\mu</math>s Gates 2 - 4: 0</b>	Length of time gated period for time gated measurements.
<i>Trigger setup</i>		
TRIG[:SEQ[1] 2]:SOUR	<b>INT1</b>	Trigger source set up and acquisition mode continuous triggering
INIT:CONT	<b>ON</b>	
TRIG[:SEQ]:LEV:AUTO	<b>OFF</b>	Disable automatic setting of the trigger level

**Table 12-17** BLUetooth: Power meter presets (continued)

Command	Setting	Comments
TRIG[:SEQ]:LEV	<b>-15 dBm</b>	Power level
TRIG[:SEQ]:SLOP	<b>POS</b>	Trigger event recognized on the rising edge of a signal
TRIG[:SEQ]:DEL	<b>0 s</b>	Delay between recognition of trigger event and start of a measurement
TRIG[:SEQ]:HOLD	<b>650 <math>\mu</math>s</b>	Trigger holdoff
<i>Range<sup>[a]</sup></i>		
[SENS[1]] SENS2:POW:AC:RANG:AUTO	<b>OFF</b>	Auto range off
[SENS[1]] SENS2:POW:AC:RANG	<b>UPPER</b>	Range set to upper
<i>Step detection</i>		
[SENSe[1]] SENS2:AVER:SDET	<b>1</b>	Step detection enabled
<i>Trace setup</i>		
SENSe[1] 2:TRAC:LIM:UPP	<b>+20 dBm</b>	Maximum power
SENSe[1] 2:TRAC:LIM:LOW	<b>-35 dBm</b>	Minimum power
[SENS[1]] SENS2:TRAC:OFFS:TIME <numeric_value>	<b>-50 <math>\mu</math>s</b>	Delay between delayed trigger point and the start of the trace
[SENS[1]] SENS2:TRAC:TIME <numeric_value>	<b>3.8 ms</b>	Length of the trace

[a] The Range setting in [Table 12-17](#) is only applicable for E-Series power sensor.

**Table 12-18** BLUetooth: Power meter presets: Window/Measurement settings

Function	Setting	
	Single Channel	Dual Channel
<i>Display setup</i>		
Upper window	Channel A trace	Primary channel <sup>[a]</sup> trace
Lower window	Dual numeric	See <a href="#">Table 12-19</a>
<i>Window/measurement setup</i>		
<i>Upper window/upper measurement (UU)</i>		
Feed	N/A	N/A
Measurement	N/A	N/A
<i>Upper window/lower measurement (UL)</i>		
Feed	N/A	N/A
Measurement	N/A	N/A
<i>Lower window/upper measurement (LU)</i>		
Feed	Gate 1 Channel A	Gate 1 primary channel <sup>[a]</sup>
Measurement	Avg	Avg
<i>Lower window/lower measurement (LL)</i>		
Feed	Gate 1 Channel A	See <a href="#">Table 12-19</a>
Measurement	Peak	See <a href="#">Table 12-19</a>

[a] For further information refer to "Primary and Secondary Channels" on page 473.

**Table 12-19** BLUetooth: Power meter presets for secondary channel sensors

Function	Secondary Channel Sensor		
	No Sensor	Non P-Series Sensor	P-Series Sensor
<i>Display setup</i>			
Lower window	Dual numeric	Dual numeric	Dual numeric
<i>Lower window/lower measurement (LL)</i>			
Feed	Gate 1 primary channel1	Secondary channel <sup>[a]</sup>	Gate1 secondary channel <sup>[a]</sup> (Channel B)
Measurement	Peak	Avg	Avg

[a] For further information refer to "Primary and Secondary Channels" on page 473.

### MCPA

The following table shows the power meter presets when `<character_data>` is set to **MCPa**. Commands not listed are preset according to their **DEFault** values (for further information refer to [Table 12-1](#)).

**Table 12-20** MPCA: Power meter presets

Command	Setting	Comments
<i>Frequency</i>		
[SENS[1]] SENS2:FREQ[:CW]:FIX]	<b>+1900.000 MHz</b>	Frequency setting
<i>Sensor measurement mode</i>		
[SENS[1]] SENS2:DET:FUNC	<b>NORM</b>	Measurement mode
<i>Sensor video bandwidth setup</i>		
[SENS[1]] SENS2:BAND BWID:VID	<b>N1921/2A: HIGH</b>	Sensor video bandwidth
<i>Gate Setup</i>		
[SENS[1]] SENS2:SWE[1] 2 3 4:OFF:TIME	<b>Gate 1: 0 s Gates 2 - 4: 0</b>	Delay between trigger point and time gated period.

**Table 12-20** MPCA: Power meter presets (continued)

Command	Setting	Comments
[SENS[1]] SENS2:SWE[1] 2 3 4:TIME	<b>Gate 1: 10 ms</b> <b>Gates 2 - 4: 0</b>	Length of time gated period for time gated measurements.
<i>Trigger setup</i>		
TRIG[:SEQ[1] 2]:SOUR	<b>INT1</b>	Trigger source set up and acquisition mode continuous triggering
INIT:CONT	<b>ON</b>	
TRIG[:SEQ]:LEV:AUTO	<b>OFF</b>	Enable automatic setting of the trigger level
TRIG[:SEQ]:LEV	<b>-15 dBm</b>	Power level
TRIG[:SEQ]:SLOP	<b>POS</b>	Trigger event recognized on the rising edge of a signal
TRIG[:SEQ]:DEL	<b>0 s</b>	Delay between recognition of trigger event and start of a measurement
TRIG[:SEQ]:HOLD	<b>MIN</b>	Trigger holdoff
<i>Range<sup>[a]</sup></i>		
[SENS[1]] SENS2:POW:AC:RANG:AUTO	<b>OFF</b>	Auto range off
[SENS[1]] SENS2:POW:AC:RANG	<b>UPPER</b>	Range set to upper
<i>Step detection</i>		
[SENSe[1]] SENS2:AVER:SDET	<b>0</b>	Step detection disabled

[a] The Range setting in Table 12-20 is only applicable for E-Series power sensor.

**Table 12-21** MPCA: Power meter presets: Window/Measurement settings

Function	Setting	
	Single Channel	Dual Channel
<i>Display setup</i>		
Upper window	UU single numeric	UU single numeric
Lower window	Dual numeric	See Table 12-22

**Table 12-21** MPCA: Power meter presets: Window/Measurement settings (continued)

Function	Setting	
	Single Channel	Dual Channel
<i>Window/measurement setup</i>		
<i>Upper window/upper measurement (UU)</i>		
Feed	Gate 1 Channel A	Gate 1 primary channel <sup>[a]</sup>
Measurement	Avg	Avg
<i>Upper window/lower measurement (UL)</i>		
Feed	DEF	See <a href="#">Table 12-2</a>
Measurement	DEF	See <a href="#">Table 12-22</a>
<i>Lower window/upper measurement (LU)</i>		
Feed	Gate 1 Channel A	See <a href="#">Table 12-22</a>
Measurement	Peak	See <a href="#">Table 12-22</a>
<i>Lower window/lower measurement (LL)</i>		
Feed	Gate 1 Channel A	See <a href="#">Table 12-22</a>
Measurement	Pk-to-Avg	See <a href="#">Table 12-22</a>

[a] For further information refer to ["Primary and Secondary Channels"](#) on page 473.

**Table 12-22** MPCA: Power meter presets for secondary channel sensors

Function	Secondary Channel Sensor		
	No Sensor	Non P-Series Sensor	P-Series Sensor
<i>Display setup</i>			
Upper window	UU single numeric	Dual numeric	Dual numeric
Lower window	Dual numeric	Dual numeric	Dual numeric
<i>Upper window/lower measurement (UL)</i>			
Feed	DEF	Gate 1 primary channel <sup>[a]</sup>	Gate 1 primary channel <sup>[a]</sup> (Channel A)



**Table 12-22** MCPA: Power meter presets for secondary channel sensors (continued)

Function	Secondary Channel Sensor		
	No Sensor	Non P-Series Sensor	P-Series Sensor
Measurement	DEF	Peak	Peak
<i>Lower window/upper measurement (LU)</i>			
Feed	Gate 1 primary channel <sup>[a]</sup>	Gate 1 primary channel <sup>[a]</sup>	Gate1 secondary channel <sup>[a]</sup> (Channel B)
Measurement	Peak	Pk-to-Avg	Avg
<i>Lower window/lower measurement (LL)</i>			
Feed	Gate 1 primary channel <sup>[a]</sup>	Secondary channel <sup>[a]</sup>	Gate1 secondary channel <sup>[a]</sup> (Channel B)
Measurement	Pk-to-Avg	Avg	Pk-to-Avg

[a] For further information refer to "Primary and Secondary Channels" on page 473.

## RADAR

The following table shows the power meter presets when `<character_data>` is set to **RADar**. Commands not listed are preset according to their **DEFauIt** values (for further information refer to [Table 12-1](#)).

**Table 12-23** RADAR: Power meter presets

Command	Setting	Comments
<i>Frequency</i>		
[SENS[1]] SENS2:FREQ[:CW]:FIX]	<b>+10.000 GHz</b>	Frequency setting
<i>Sensor measurement mode</i>		
[SENS[1]] SENS2:DET:FUNC	<b>NORM</b>	Measurement mode
<i>Sensor video bandwidth setup</i>		
[SENS[1]] SENS2:BAND BWID:VID	<b>N1921/2A: OFF</b>	Sensor video bandwidth
<i>Gate Setup</i>		

**Table 12-23** RADAR: Power meter presets (continued)

Command	Setting	Comments
[SENS[1]] SENS2:SWE[1] 2 3 4:OFF:TIME	<b>Gate 1: 0</b> <b>Gate 2: 0</b> <b>Gate 3: 750 ns</b> <b>Gate 4: 0</b>	Delay between trigger point and time gated period.
[SENS[1]] SENS2:SWE[1] 2 3 4:TIME	<b>Gate 1: 1.0 <math>\mu</math>s</b> <b>Gate 2: 250 ns</b> <b>Gate 3: 250 ns</b> <b>Gate 4: 0</b>	Length of time gated period for time gated measurements.
<i>Trigger setup</i>		
TRIG[:SEQ[1] 2]:SOUR	<b>INT1</b>	Trigger source set up and acquisition mode continuous triggering
INIT:CONT	<b>ON</b>	
TRIG[:SEQ]:LEV:AUTO	<b>ON</b>	Disable automatic setting of the trigger level
TRIG[:SEQ]:LEV	<b>AUTO</b>	Automatic Power level
TRIG[:SEQ]:SLOP	<b>POS</b>	Trigger event recognized on the rising edge of a signal
TRIG[:SEQ]:DEL	<b>0 s</b>	Delay between recognition of trigger event and start of a measurement
TRIG[:SEQ]:HOLD	<b>MIN</b>	Trigger holdoff
<i>Range<sup>[a]</sup></i>		
[SENS[1]] SENS2:POW:AC:RANG:AUTO	<b>OFF</b>	Auto range off
[SENS[1]] SENS2:POW:AC:RANG	<b>UPPER</b>	Range set to upper
<i>Step detection</i>		
[SENS[1]] SENS2:AVER:SDET	<b>0</b>	Step detection disabled
<i>Trace setup</i>		
[SENS[1]] SENS2:TRAC:OFFS:TIME <numeric_value>	<b>-250 ns</b>	Delay between delayed trigger point and the start of the trace
[SENS[1]] SENS2:TRAC:TIME <numeric_value>	<b>1.5 <math>\mu</math>s</b>	Length of the trace

[a] The Range setting in [Table 12-23](#) is only applicable for E-Series power sensor.

**Table 12-24** RADAR: Power meter presets: Window/Measurement settings

Function	Setting	
	Single Channel	Dual Channel
<i>Display setup</i>		
Upper window	Channel A trace	See <a href="#">Table 12-25</a>
Lower window	Dual numeric	Dual numeric
<i>Window/measurement setup</i>		
<i>Upper window/upper measurement (UU)</i>		
Feed	Gate 1 Channel A	See <a href="#">Table 12-25</a>
Measurement	Pk-to-Avg	See <a href="#">Table 12-25</a>
<i>Upper window/lower measurement (UL)</i>		
Feed 1	Gate 2 Channel A - Avg	See <a href="#">Table 12-25</a>
Feed 2		See <a href="#">Table 12-25</a>
Measurement	Feed 1/ Feed 2	See <a href="#">Table 12-25</a>
<i>Lower window/upper measurement (LU)</i>		
Feed	Gate 1 Channel A	See <a href="#">Table 12-25</a>
Measurement	Peak	See <a href="#">Table 12-25</a>
<i>Lower window/lower measurement (LL)</i>		
Feed	Gate 1 Channel A	See <a href="#">Table 12-25</a>
Measurement	Avg	See <a href="#">Table 12-25</a>

**Table 12-25** RADAR: Power meter presets for secondary channel sensors

Function	Secondary Channel Sensor		
	No Sensor	Non P-Series Sensor	P-Series Sensor
<i>Display setup</i>			
Upper window	Primary Channel Trace	Dual numeric	Dual numeric
Lower window	Dual numeric	Dual numeric	Dual numeric
<i>Upper window/upper measurement (UU)</i>			
Feed	Gate 1 primary channel <sup>[a]</sup>	Gate 1 primary channel <sup>[a]</sup>	Gate 1 primary channel <sup>[a]</sup>
Measurement	Pk-to-Avg	Peak	Peak
<i>Upper window/lower measurement (UL)</i>			
Feed 1	Gate 2 primary channel <sup>[a]</sup>	Gate 1 primary channel <sup>[a]</sup>	Gate 1 primary channel <sup>[a]</sup>
Feed 2			
Measurement	Avg	Peak	Avg
<i>Lower window/upper measurement (LU)</i>			
Feed 1	Gate 1 primary channel <sup>[a]</sup>	Gate 2 primary channel <sup>[a]</sup>	Gate1 secondary channel <sup>[a]</sup> (Channel B)
Feed 2			
Measurement	Peak	Avg	Peak
<i>Lower window/lower measurement (LL)</i>			
Feed	Gate 1 primary channel <sup>[a]</sup>	Secondary channel <sup>[a]</sup>	Gate1 secondary channel <sup>[a]</sup> (Channel B)
Measurement	Avg	Avg	Avg

[a] For further information refer to "Primary and Secondary Channels" on page 473.

### 802.11a and HiperLan2

The following table shows the power meter presets when `<character_data>` is set to **802DOT11A** and **HIPERLAN2**. Commands not listed are preset according to their **DEFault** values (for further information refer to [Table 12-1](#)).

**Table 12-26** 802.11a and HiperLan2: Power meter presets

Command	Setting	Comments
<i>Frequency</i>		
[SENS[1]] SENS2:FREQ[:CW :FIX]	<b>+5200.000 MHz</b>	Frequency setting
<i>Sensor measurement mode</i>		
[SENS[1]] SENS2:DET:FUNC	<b>NORM</b>	Measurement mode
<i>Sensor video bandwidth setup</i>		
[SENS[1]] SENS2:BAND BWID:VID	<b>N1921/2A: HIGH</b>	Sensor video bandwidth
<i>Gate Setup</i>		
[SENS[1]] SENS2:SWE[1] 2 3 4:OFF:TIME	<b>Gate 1: 0 Gates 2 - 4: 0</b>	Delay between trigger point and time gated period.
[SENS[1]] SENS2:SWE[1] 2 3 4:TIME	<b>Gate 1: 25 <math>\mu</math>s Gates 2 - 4: 0</b>	Length of time gated period for time gated measurements.
<i>Trigger setup</i>		
TRIG[:SEQ[1] 2]:SOUR	<b>INT1</b>	Trigger source set up and acquisition mode continuous triggering
INIT:CONT	<b>ON</b>	
TRIG[:SEQ]:LEV:AUTO	<b>ON</b>	Enable automatic setting of the trigger level
TRIG[:SEQ]:LEV	<b>AUTO</b>	Power level
TRIG[:SEQ]:SLOP	<b>POS</b>	Trigger event recognized on the rising edge of a signal
TRIG[:SEQ]:DEL	<b>0 s</b>	Delay between recognition of trigger event and start of a measurement
TRIG[:SEQ]:HOLD	<b>MIN</b>	Trigger holdoff
<i>Range<sup>[a]</sup></i>		
[SENS[1]] SENS2:POW:AC:RANG:AUTO	<b>OFF</b>	Auto range off
[SENS[1]] SENS2:POW:AC:RANG	<b>UPPER</b>	Range set to upper
<i>Step detection</i>		
[SENSe[1]] SENS2:AVER:SDET	<b>0</b>	Step detection disabled

[a] The Range setting in Table 12-26 is only applicable for E-Series power sensor.

**Table 12-27** 802.11a and HiperLan2: Power meter presets: Window/Measurement settings

Function	Setting	
	Single Channel	Dual Channel
<i>Display setup</i>		
Upper window	UU Single Numeric	UU Single Numeric
Lower window	Dual numeric	See <a href="#">Table 12-28</a>
<i>Window/measurement setup</i>		
<i>Upper window/upper measurement (UU)</i>		
Feed	Gate 1 Channel A	Gate 1 primary channel <sup>[a]</sup>
Measurement	Avg	Avg
<i>Upper window/lower measurement (UL)</i>		
Feed	DEF	See <a href="#">Table 12-28</a>
Measurement	DEF	See <a href="#">Table 12-28</a>
<i>Lower window/upper measurement (LU)</i>		
Feed	Gate 1 Channel A	See <a href="#">Table 12-28</a>
Measurement	Peak	See <a href="#">Table 12-28</a>
<i>Lower window/lower measurement (LL)</i>		
Feed	Gate 1 Channel A	See <a href="#">Table 12-28</a>
Measurement	Pk-to-Avg	See <a href="#">Table 12-28</a>

[a] For further information refer to "[Primary and Secondary Channels](#)" on page 473.

**Table 12-28** 802.11a and HiperLan2: Power meter presets for secondary channel sensors

Function	Secondary Channel Sensor		
	No Sensor	Non P-Series Sensor	P-Series Sensor
<i>Display setup</i>			
Upper window	UU Single numeric	Dual numeric	Dual numeric
Lower window	Dual numeric	Dual numeric	Dual numeric
<i>Upper window/lower measurement (UL)</i>			
Feed	DEF	Gate 1 primary channel <sup>[a]</sup>	Gate1 primary channel <sup>[a]</sup> (Channel A)
Measurement	DEF	Peak	Peak
<i>Lower window/upper measurement (LU)</i>			
Feed	Gate 1 primary channel <sup>[a]</sup>	Gate 1 primary channel <sup>[a]</sup>	Gate 1 secondary channel <sup>[a]</sup> (Channel B)
Measurement	Peak	Pk-to-Avg	Avg
<i>Lower window/lower measurement (LL)</i>			
Feed	Gate 1 primary channel <sup>[a]</sup>	Secondary channel <sup>[a]</sup>	Gate 1 secondary channel <sup>[a]</sup> (Channel B)
Measurement	Pk-to-Avg	Avg	Pk-to-Avg

[a] For further information refer to “Primary and Secondary Channels” on page 473.

### 892.11b/g

The following table shows the power meter presets when `<character_data>` is set to **802DOT11B**. Commands not listed are preset according to their **DEFault** values (for further information refer to [Table 12-1](#)).

**Table 12-29** 802.11b/g: Power meter presets

Command	Setting	Comments
<i>Frequency</i>		
[SENS[1]]   SENS2:FREQ[:CW :FIX]	<b>+2.400 GHz</b>	Frequency setting
<i>Sensor measurement mode</i>		
[SENS[1]]   SENS2:DET:FUNC	<b>NORM</b>	Measurement mode
<i>Sensor video bandwidth setup</i>		
[SENS[1]]   SENS2:BAND BWID:VID	<b>N1921/2A: HIGH</b>	Sensor video bandwidth
<i>Gate Setup</i>		
[SENS[1]]   SENS2:SWE[1] 2 3 4:OFF:TIME	<b>Gate 1: 0 Gates 2 - 4: 0</b>	Delay between trigger point and time gated period.
[SENS[1]]   SENS2:SWE[1] 2 3 4:TIME	<b>Gate 1: 100 <math>\mu</math>s Gates 2 - 4: 0</b>	Length of time gated period for time gated measurements.
<i>Trigger setup</i>		
TRIG[:SEQ[1] 2]:SOUR	<b>INT1</b>	Trigger source set up and acquisition mode continuous triggering
INIT:CONT	<b>ON</b>	
TRIG[:SEQ]:LEV:AUTO	<b>ON</b>	Enable automatic setting of the trigger level
TRIG[:SEQ]:LEV	<b>AUTO</b>	Power level
TRIG[:SEQ]:SLOP	<b>POS</b>	Trigger event recognized on the rising edge of a signal
TRIG[:SEQ]:DEL	<b>0 s</b>	Delay between recognition of trigger event and start of a measurement
TRIG[:SEQ]:HOLD	<b>MIN</b>	Trigger holdoff
<i>Range<sup>[a]</sup></i>		
[SENS[1]]   SENS2:POW:AC:RANG:AUTO	<b>OFF</b>	Auto range off
[SENS[1]]   SENS2:POW:AC:RANG	<b>UPPER</b>	Range set to upper
<i>Step detection</i>		
[SENSe[1]]   SENS2:AVER:SDET	<b>0</b>	Step detection disabled



[a] The Range setting in [Table 12-9](#) is only applicable for E-Series power sensor.

**Table 12-30** 802.11b/g: Power meter presets: Window/Measurement settings

Function	Setting	
	Single Channel	Dual Channel
<i>Display setup</i>		
Upper window	UU Single Numeric	UU Single Numeric
Lower window	Dual numeric	See <a href="#">Table 12-31</a>
<i>Window/measurement setup</i>		
<i>Upper window/upper measurement (UU)</i>		
Feed	Gate 1 Channel A	Gate 1 primary channel <sup>[a]</sup>
Measurement	Avg	Avg
<i>Upper window/lower measurement (UL)</i>		
Feed	DEF	See <a href="#">Table 12-31</a>
Measurement	DEF	See <a href="#">Table 12-31</a>
<i>Lower window/upper measurement (LU)</i>		
Feed	Gate 1 Channel A	See <a href="#">Table 12-31</a>
Measurement	Peak	See <a href="#">Table 12-31</a>
<i>Lower window/lower measurement (LL)</i>		
Feed	Gate 1 Channel A	See <a href="#">Table 12-31</a>
Measurement	Pk-to-Avg	See <a href="#">Table 12-31</a>

[a] For further information refer to "Primary and Secondary Channels" on page 473.

**Table 12-31** 802.11b/g: Power meter presets for secondary channel sensors

Function	Secondary Channel Sensor		
	No Sensor	Non P-Series Sensor	P-Series Sensor
<i>Display setup</i>			
Upper window	UU Single numeric	Dual numeric	Dual numeric
Lower window	Dual numeric	Dual numeric	Dual numeric
<i>Upper window/lower measurement (UL)</i>			
Feed	DEF	Gate 1 primary channel <sup>[a]</sup>	Gate1 primary channel <sup>[a]</sup> (Channel A)
Measurement	DEF	Peak	Peak
<i>Lower window/upper measurement (LU)</i>			
Feed	Gate 1 primary channel <sup>[a]</sup>	Gate 1 primary channel*	Gate 1 secondary channel <sup>[a]</sup> (Channel B)
Measurement	Peak	Pk-to-Avg	Avg
<i>Lower window/lower measurement (LL)</i>			
Feed	Gate 1 primary channel <sup>[a]</sup>	Secondary channel <sup>[a]</sup>	Gate1 secondary channel <sup>[a]</sup> (Channel B)
Measurement	Pk-to-Avg	Avg	Pk-to-Avg

[a] For further information refer to "Primary and Secondary Channels" on page 473.

### 1xeV-DO

The following table shows the power meter presets when `<character_data>` is set to **XEVDO**. Commands not listed are preset according to their **DEFault** values (for further information refer to [Table 12-1](#)).

**Table 12-32** 1xeV-DO: Power meter presets

Command	Setting	Comments
<i>Frequency</i>		
[SENS[1]] SENS2:FREQ[:CW :FIX]	<b>+1900.000 MHz</b>	Frequency setting
<i>Sensor measurement mode</i>		
[SENS[1]] SENS2:DET:FUNC	<b>NORM</b>	Measurement mode
<i>Sensor video bandwidth setup</i>		
[SENS[1]] SENS2:BAND BWID:VID	<b>N1921/2A: LOW</b>	Sensor video bandwidth
<i>Gate Setup</i>		
[SENS[1]] SENS2:SWE[1] 2 3 4:OFF:TIME	<b>Gate 1: 10 <math>\mu</math>s Gates 2 - 4: 0</b>	Delay between trigger point and time gated period.
[SENS[1]] SENS2:SWE[1] 2 3 4:TIME	<b>Gate 1: 810 <math>\mu</math>s Gates 2 - 4: 0</b>	Length of time gated period for time gated measurements.
<i>Trigger setup</i>		
TRIG[:SEQ[1] 2]:SOUR	<b>INT1</b>	Trigger source set up and acquisition mode continuous triggering
INIT:CONT	<b>ON</b>	
TRIG[:SEQ]:LEV:AUTO	<b>ON</b>	Enable automatic setting of the trigger level
TRIG[:SEQ]:LEV	<b>AUTO</b>	Power level
TRIG[:SEQ]:SLOP	<b>POS</b>	Trigger event recognized on the rising edge of a signal
TRIG[:SEQ]:DEL	<b>0 s</b>	Delay between recognition of trigger event and start of a measurement
TRIG[:SEQ]:HOLD	<b>1 ms</b>	Trigger holdoff
<i>Range<sup>[a]</sup></i>		
[SENS[1]] SENS2:POW:AC:RANG:AUTO	<b>OFF</b>	Auto range off
[SENS[1]] SENS2:POW:AC:RANG	<b>UPPER</b>	Range set to upper
<i>Step detection</i>		
[SENSe[1]] SENS2:AVER:SDET	<b>0</b>	Step detection disabled

**Table 12-32** 1xeV-DO: Power meter presets (continued)

Command	Setting	Comments
<i>Trace setup</i>		
[SENS[1]] SENS2:TRAC:OFFS:TIME <numeric_value>	-40 $\mu$ s	Delay between delayed trigger point and the start of the trace
[SENS[1]] SENS2:TRAC:TIME <numeric_value>	1 ms	Length of the trace

[a] The Range setting in [Table 12-32](#) is only applicable for E-Series power sensor.

**Table 12-33** 1 exV-DO: Power meter presets: Window/Measurement settings

Function	Setting	
	Single Channel	Dual Channel
<i>Display setup</i>		
Upper window	Channel A trace	Primary channel <sup>[a]</sup> trace
Lower window	Dual numeric	See <a href="#">Table 12-34</a>
<i>Window/measurement setup</i>		
<i>Upper window/upper measurement (UU)</i>		
Feed	N/A	N/A
Measurement	N/A	N/A
<i>Upper window/lower measurement (UL)</i>		
Feed	N/A	N/A
Measurement	N/A	N/A
<i>Lower window/upper measurement (LU)</i>		
Feed	Gate 1 Channel A	Gate 1 primary channel*
Measurement	Avg	Avg
<i>Lower window/lower measurement (LL)</i>		

**Table 12-33** 1 exV-DO: Power meter presets: Window/Measurement settings

Function	Setting	
	Single Channel	Dual Channel
Feed	Gate 1 Channel A	See <a href="#">Table 12-34</a>
Measurement	Pk-to-Avg	See <a href="#">Table 12-34</a>

[a] For further information refer to "[Primary and Secondary Channels](#)" on page 473.

**Table 12-34** 1exV-DO: Power meter presets for secondary channel sensors

Function	Secondary Channel Sensor		
	No Sensor	Non P-Series Sensor	P-Series Sensor
<i>Display setup</i>			
Lower window	Dual numeric	Dual numeric	Dual numeric
<i>Lower window/lower measurement (LL)</i>			
Feed	Gate 1 primary channel <sup>[a]</sup>	Secondary channel <sup>[a]</sup>	Gate1 secondary channel <sup>[a]</sup> (Channel B)
Measurement	Pk-to-Avg	Avg	Avg

[a] For further information refer to "Primary and Secondary Channels" on page 473.

### 1xeV-DV

The following table shows the power meter presets when `<character_data>` is set to **XEVDV**. Commands not listed are preset according to their **DEFault** values (for further information refer to [Table 12-1](#)).

**Table 12-35** 1exV-DV: Power meter presets

Command	Setting	Comments
<i>Frequency</i>		
[SENS[1]] SENS2:FREQ[:CW]:FIX]	<b>+1900.000 MHz</b>	Frequency setting
<i>Sensor measurement mode</i>		
[SENS[1]] SENS2:DET:FUNC	<b>NORM</b>	Measurement mode
<i>Sensor video bandwidth setup</i>		
[SENS[1]] SENS2:BAND BWID:VID	<b>N1921/2A: LOW</b>	Sensor video bandwidth
<i>Gate Setup</i>		
[SENS[1]] SENS2:SWE[1] 2 3 4:OFF:TIME	<b>Gate 1: 10 <math>\mu</math>s</b> <b>Gates 2 - 4: 0</b>	Delay between trigger point and time gated period.

**Table 12-35** 1exV-DV: Power meter presets (continued)

Command	Setting	Comments
[SENS[1]] SENS2:SWE[1] 2 3 4:TIME	<b>Gate 1: 810 <math>\mu</math>s</b> <b>Gates 2 - 4: 0</b>	Length of time gated period for time gated measurements.
<i>Trigger setup</i>		
TRIG[:SEQ[1] 2]:SOUR	<b>INT1</b>	Trigger source set up and acquisition mode continuous triggering
INIT:CONT	<b>ON</b>	
TRIG[:SEQ]:LEV:AUTO	<b>ON</b>	Enable automatic setting of the trigger level
TRIG[:SEQ]:LEV	<b>AUTO</b>	Power level
TRIG[:SEQ]:SLOP	<b>POS</b>	Trigger event recognized on the rising edge of a signal
TRIG[:SEQ]:DEL	<b>0 s</b>	Delay between recognition of trigger event and start of a measurement
TRIG[:SEQ]:HOLD	<b>1 ms</b>	Trigger holdoff
<i>Range<sup>[a]</sup></i>		
[SENS[1]] SENS2:POW:AC:RANG:AUTO	<b>OFF</b>	Auto range off
[SENS[1]] SENS2:POW:AC:RANG	<b>UPPER</b>	Range set to upper
<i>Step detection</i>		
[SENSe[1]] SENS2:AVER:SDET	<b>0</b>	Step detection disabled
<i>Trace setup</i>		
[SENS[1]] SENS2:TRAC:OFFS:TIME <numeric_value>	<b>-40 <math>\mu</math>s</b>	Delay between delayed trigger point and the start of the trace
[SENS[1]] SENS2:TRAC:TIME <numeric_value>	<b>1 ms</b>	Length of the trace

[a] The Range setting in Table 12-35 is only applicable for E-Series power sensor.

**Table 12-36** 1xeV-DV: Power meter presets: Window/Measurement settings

Function	Setting	
	Single Channel	Dual Channel
<i>Display setup</i>		
Upper window	Channel A trace	Primary channel <sup>[a]</sup> trace
Lower window	Dual numeric	See <a href="#">Table 12-37</a>
<i>Window/measurement setup</i>		
<i>Upper window/upper measurement (UU)</i>		
Feed	N/A	N/A
Measurement	N/A	N/A
<i>Upper window/lower measurement (UL)</i>		
Feed	N/A	N/A
Measurement	N/A	N/A
<i>Lower window/upper measurement (LU)</i>		
Feed	Gate 1 Channel A	Gate 1 primary channel*
Measurement	Avg	Avg
<i>Lower window/lower measurement (LL)</i>		
Feed	Gate 1 Channel A	See <a href="#">Table 12-37</a>
Measurement	Pk-to-Avg	See <a href="#">Table 12-37</a>

[a] For further information refer to ["Primary and Secondary Channels"](#) on page 473.



**Table 12-37** 1xeV-DV: Power meter presets for secondary channel sensors

Function	Secondary Channel Sensor		
	No Sensor	Non P-Series Sensor	P-Series Sensor
<i>Display setup</i>			
Lower window	Dual numeric	Dual numeric	Dual numeric
<i>Lower window/lower measurement (LL)</i>			
Feed	Gate 1 primary channel <sup>[a]</sup>	Secondary channel <sup>[a]</sup>	Gate 1 secondary channel <sup>[a]</sup> (Channel B)
Measurement	Pk-to-Avg	Avg	Avg

[a] For further information refer to “Primary and Secondary Channels” on page 473.

## TD-SCDMA

The following table shows the power meter presets when `<character_data>` is set to **TDSCdma**. Commands not listed are preset according to their **DEFault** values (for further information refer to [Table 12-1](#)).

**Table 12-38** TD-SCDMA: Power meter presets

Command	Setting	Comments
<i>Frequency</i>		
[SENS[1]] SENS2:FREQ[:CW]:FIX	<b>+1900.000 MHz</b>	Frequency setting
<i>Sensor measurement mode</i>		
[SENS[1]] SENS2:DET:FUNC	<b>NORM</b>	Measurement mode
<i>Sensor video bandwidth setup</i>		
[SENS[1]] SENS2:BAND BWID:VID	<b>N1921/2A: LOW</b>	Sensor video bandwidth
<i>Gate Setup</i>		
[SENS[1]] SENS2:SWE[1] 2 3 4:OFF:TIME	<b>Gate 1: 10 <math>\mu</math>s Gates 2 - 4: 0</b>	Delay between trigger point and time gated period.

**Table 12-38** TD-SCDMA: Power meter presets (continued)

Command	Setting	Comments
[SENS[1]] SENS2:SWE[1] 2 3 4:TIME	<b>Gate 1: 810 <math>\mu</math>s</b> <b>Gates 2 - 4: 0</b>	Length of time gated period for time gated measurements.
<i>Trigger setup</i>		
TRIG[:SEQ[1] 2]:SOUR	<b>INT1</b>	Trigger source set up and acquisition mode continuous triggering
INIT:CONT	<b>ON</b>	
TRIG[:SEQ]:LEV:AUTO	<b>ON</b>	Enable automatic setting of the trigger level
TRIG[:SEQ]:LEV	<b>AUTO</b>	Power level
TRIG[:SEQ]:SLOP	<b>POS</b>	Trigger event recognized on the rising edge of a signal
TRIG[:SEQ]:DEL	<b>0 s</b>	Delay between recognition of trigger event and start of a measurement
TRIG[:SEQ]:HOLD	<b>1 ms</b>	Trigger holdoff
<i>Range<sup>[a]</sup></i>		
[SENS[1]] SENS2:POW:AC:RANG:AUTO	<b>OFF</b>	Auto range off
[SENS[1]] SENS2:POW:AC:RANG	<b>UPPER</b>	Range set to upper
<i>Step detection</i>		
[SENSe[1]] SENS2:AVER:SDET	<b>0</b>	Step detection disabled
<i>Trace setup</i>		
[SENS[1]] SENS2:TRAC:OFFS:TIME <numeric_value>	<b>-40 <math>\mu</math>s</b>	Delay between delayed trigger point and the start of the trace
[SENS[1]] SENS2:TRAC:TIME <numeric_value>	<b>1 ms</b>	Length of the trace

[a] The Range setting in [Table 12-38](#) is only applicable for E-Series power sensor.

**Table 12-39** TD-SCDMA: Power meter presets: Window/Measurement settings

Function	Setting	
	Single Channel	Dual Channel
<i>Display setup</i>		
Upper window	Channel A trace	Primary channel <sup>[a]</sup> trace
Lower window	Dual numeric	See <a href="#">Table 12-40</a>
<i>Window/measurement setup</i>		
<i>Upper window/upper measurement (UU)</i>		
Feed	N/A	N/A
Measurement	N/A	N/A
<i>Upper window/lower measurement (UL)</i>		
Feed	N/A	N/A
Measurement	N/A	N/A
<i>Lower window/upper measurement (LU)</i>		
Feed	Gate 1 Channel A	Gate 1 primary channel*
Measurement	Avg	Avg
<i>Lower window/lower measurement (LL)</i>		
Feed	Gate 1 Channel A	See <a href="#">Table 12-40</a>
Measurement	Pk-to-Avg	See <a href="#">Table 12-40</a>

[a] For further information refer to "Primary and Secondary Channels" on page 473.

**Table 12-40** TD-SCDMA: Power meter presets: Window/Measurement settings

Function	Secondary Channel Sensor		
	No Sensor	Non P-Series Sensor	P-Series Sensor
<i>Display setup</i>			
Lower window	Dual numeric	Dual numeric	Dual numeric
<i>Lower window/lower measurement (LL)</i>			
Feed	Gate 1 primary channel <sup>[a]</sup>	Secondary channel <sup>[a]</sup>	Gate1 secondary channel <sup>[a]</sup> (Channel B)
Measurement	Pk-to-Avg	Avg	Avg

[a] For further information refer to "Primary and Secondary Channels" on page 473.

## NADC

The NADC set-up provides:

- Average power measurement of both active timeslots in NADC or IS-136 "full rate" transmission. This assumes that there are two timeslots to be measured in each frame as for example with timeslots 0 in the following diagram:

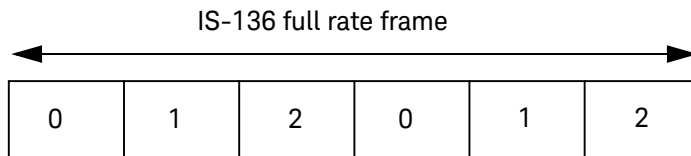

**Figure 12-2** A trace display of the active timeslots

- A trace display of the active timeslots.

The measurement is started by detecting the RF burst—for example the burst emitted by a mobile—using the internal RF level trigger. The internal level trigger is set to  $-20$  dBm. Time-gating is used to measure the average power in two active timeslots which are separated by two inactive timeslots

The following table shows the power meter presets when `<character_data>` is set to **NADC**. Commands not listed are preset according to their **DEFault** values (for further information refer to [Table 12-1](#)):

**Table 12-41** NADC: Power meter presets

Command	Setting	Comments
<i>Frequency</i>		
[SENS[1]] SENS2:FREQ[:CW]:FIX]	<b>+800.000 MHz</b>	Frequency setting
<i>Sensor measurement mode</i>		
[SENS[1]] SENS2:DET:FUNC	<b>NORM</b>	Measurement mode
<i>Sensor video bandwidth setup</i>		
[SENS[1]] SENS2:BAND BWID:VID	<b>N1921/2A: OFF</b>	Sensor video bandwidth
<i>Gate Setup</i>		
[SENS[1]] SENS2:SWE[1] 2 3 4:OFF:TIME	<b>Gate 1: 123.5 <math>\mu</math>s Gate 2: 20.123 ms Gates 3 - 4: 0</b>	Delay between trigger point and time gated period.
[SENS[1]] SENS2:SWE[1] 2 3 4:TIME	<b>Gate 1: 6.46 ms Gate 2: 6.46 ms Gates 3 - 4: 0</b>	Length of time gated period for time gated measurements.
<i>Trigger setup</i>		
TRIG[:SEQ[1] 2]:SOUR	<b>INT1</b>	Trigger source set up and acquisition mode continuous triggering
INIT:CONT	<b>ON</b>	
TRIG[:SEQ]:LEV:AUTO	<b>OFF</b>	Disable automatic setting of the trigger level
TRIG[:SEQ]:LEV	<b>-15 dBm</b>	Power level
TRIG[:SEQ]:SLOP	<b>POS</b>	Trigger event recognized on the rising edge of a signal
TRIG[:SEQ]:DEL	<b>0 s</b>	Delay between recognition of trigger event and start of a measurement
TRIG[:SEQ]:HOLD	<b>30 ms</b>	Trigger holdoff
<i>Range<sup>[a]</sup></i>		

**Table 12-41** NADC: Power meter presets (continued)

Command	Setting	Comments
[SENS[1]] SENS2:POW:AC:RANG:AUTO	<b>OFF</b>	Auto range off
[SENS[1]] SENS2:POW:AC:RANG	<b>UPPER</b>	Range set to upper
<i>Step detection</i>		
[SENSe[1]] SENS2:AVER:SDET	<b>1</b>	Step detection enabled
<i>Trace setup</i>		
SENSe[1] 2:TRAC:LIM:UPP	<b>+20 dBm</b>	Maximum power
SENSe[1] 2:TRAC:LIM:LOW	<b>-35 dBm</b>	Minimum power
[SENS[1]] SENS2:TRAC:OFFS:TIME <numeric_value>	<b>-0.2 ms</b>	Delay between delayed trigger point and the start of the trace
[SENS[1]] SENS2:TRAC:TIME <numeric_value>	<b>28 ms</b>	Length of the trace

[a] The Range setting in [Table 12-41](#) is only applicable for E-Series power sensor.

**Table 12-42** NADC: Power meter presets: Window/Measurement settings

Function	Setting	
	Single Channel	Dual Channel
<i>Display setup</i>		
Upper window	Channel A trace	Primary channel <sup>[a]</sup> trace
Lower window	Dual numeric	See <a href="#">Table 12-43</a>
<i>Window/measurement setup</i>		
<i>Upper window/upper measurement (UU)</i>		
Feed	N/A	N/A
Measurement	N/A	N/A
<i>Upper window/lower measurement (UL)</i>		
Feed	N/A	N/A

**Table 12-42** NADC: Power meter presets: Window/Measurement settings (continued)

Function	Setting	
	Single Channel	Dual Channel
Measurement	N/A	N/A
<i>Lower window/upper measurement (LU)</i>		
Feed	Gate 1 Channel A	Gate 1 primary channel <sup>[a]</sup>
Measurement	Avg	Avg
<i>Lower window/lower measurement (LL)</i>		
Feed	Gate 2 Channel A	See <a href="#">Table 12-43</a>
Measurement	Avg	See <a href="#">Table 12-43</a>

[a] For further information refer to “Primary and Secondary Channels” on page 473.

**Table 12-43** NADC: Power meter presets for secondary channel sensors

Function	Secondary Channel Sensor		
	No Sensor	Non P-Series Sensor	P-Series Sensor
<i>Display setup</i>			
Lower window	Dual numeric	Dual numeric	Dual numeric
<i>Lower window/lower measurement (LL)</i>			
Feed	Gate 2 primary channel <sup>[a]</sup>	Secondary channel <sup>[a]</sup>	Gate1 secondary channel <sup>[a]</sup> (Channel B)
Measurement	Avg	Avg	Avg

[a] For further information refer to “Primary and Secondary Channels” on page 473.

## iDEN

The iDEN set-up provides:

- Average power in one iDEN training and data pulse
- Peak-to-average one iDEN training and data pulse
- Average power in a 90ms iDEN frame

The measurement is started by detecting the iDEN training burst—for example the burst emitted by a mobile—using the internal RF level trigger. Time gating is used to measure the average power in the following 15 ms (data pulse). Gate 1 is used to measure this data pulse. The 90 ms frame is also captured to measure the average power in the entire frame. Gate 2 is used to measure the 90 ms frame.

The following table shows the power meter presets when `<character_data>` is set to **iDEN**. Commands not listed are preset according to their **DEFault** values (for further information refer to [Table 12-1](#)):

**Table 12-44** iDEN: Power meter presets

Command	Setting	Comments
<i>Frequency</i>		
[SENS[1]] SENS2:FREQ[:CW]:FIX]	<b>+800.000 MHz</b>	Frequency setting
<i>Sensor measurement mode</i>		
[SENS[1]] SENS2:DET:FUNC	<b>NORM</b>	Measurement mode
<i>Sensor video bandwidth setup</i>		
[SENS[1]] SENS2:BAND BWID:VID	<b>N1921/2A: OFF</b>	Sensor video bandwidth
<i>Gate Setup</i>		
[SENS[1]] SENS2:SWE[1] 2 3 4:OFF:TIME	<b>Gate 1: 0 <math>\mu</math>s</b> <b>Gates 2 - 4: 0</b>	Delay between trigger point and time gated period.
[SENS[1]] SENS2:SWE[1] 2 3 4:TIME	<b>Gate 1: 15 ms</b> <b>Gate 2: 90 ms</b> <b>Gate 3: 160 <math>\mu</math>s</b> <b>Gate 4: 0</b>	Length of time gated period for time gated measurements.



**Table 12-44** iDEN: Power meter presets (continued)

Command	Setting	Comments
<i>Trigger setup</i>		
TRIG[:SEQ[1] 2]:SOUR	INT1	Trigger source set up and acquisition mode continuous triggering
INIT:CONT	ON	
TRIG[:SEQ]:LEV:AUTO	OFF	Disable automatic setting of the trigger level
TRIG[:SEQ]:LEV	-15 dBm	Automatic Power level
TRIG[:SEQ]:SLOP	POS	Trigger event recognized on the rising edge of a signal
TRIG[:SEQ]:DEL	0 s	Delay between recognition of trigger event and start of a measurement
TRIG[:SEQ]:HOLD	20 ms	Trigger holdoff
<i>Range<sup>[a]</sup></i>		
[SENS[1]] SENS2:POW:AC:RANG:AUTO	OFF	Auto range off
[SENS[1]] SENS2:POW:AC:RANG	UPPER	Range set to upper
<i>Averaging</i>		
[SENSe[1]] SENSe2:AVER[:STATe]	ON	Averaging On
[SENSe[1]] SENSe2:AVER:COUN	64	Averaging set to 64
<i>Step detection</i>		
[SENSe[1]] SENS2:AVER:SDET	1	Step detection enabled
<i>Trace setup</i>		
SENSe[1] 2:TRAC:LIM:UPP	+20 dBm	Maximum power
SENSe[1] 2:TRAC:LIM:LOW	-30 dBm	Minimum power
[SENS[1]] SENS2:TRAC:OFFS:TIME <numeric_value>	0 s	Delay between delayed trigger point and the start of the trace
[SENS[1]] SENS2:TRAC:TIME <numeric_value>	100 ms	Length of the trace

[a] The Range setting in [Table 12-44](#) is only applicable for E-Series power sensor.

**Table 12-45** iDEN: Power meter presets: Window/Measurement settings

Function	Setting	
	Single Channel	Dual Channel
<i>Display setup</i>		
Upper window	UU single numeric	See <a href="#">Table 12-46</a>
Lower window	Dual numeric	See <a href="#">Table 12-46</a>
<i>Window/measurement setup</i>		
<i>Upper window/upper measurement (UU)</i>		
Feed	Gate 1 Channel A	Gate 1 primary channel <sup>[a]</sup>
Measurement	Avg	Avg
<i>Upper window/lower measurement (UL)</i>		
Feed	DEF	See <a href="#">Table 12-46</a>
Measurement	DEF	See <a href="#">Table 12-46</a>
<i>Lower window/upper measurement (LU)</i>		
Feed	Gate 1 Channel A	See <a href="#">Table 12-46</a>
Measurement	Peak	See <a href="#">Table 12-46</a>
<i>Lower window/lower measurement (LL)</i>		
Feed	Gate 1 Channel A	See <a href="#">Table 12-46</a>
Measurement	Pk-to-Avg	See <a href="#">Table 12-46</a>

[a] For further information refer to “[Primary and Secondary Channels](#)” on page 473.

**Table 12-46** iDEN: Power meter presets for secondary channel sensors

Function	Secondary Channel Sensor		
	No Sensor	Non P-Series Sensor	P-Series Sensor
<i>Display setup</i>			
Upper window	UU single numeric	Dual numeric	Dual numeric
Lower window	Dual numeric	Dual numeric	Dual numeric
<i>Upper window/lower measurement (UL)</i>			
Feed	DEF	Gate 1 primary channel <sup>[a]</sup>	Gate 1 primary channel <sup>[a]</sup> (Channel A)
Measurement	DEF	Peak	Peak
<i>Lower window/upper measurement (LU)</i>			
Feed	Gate 1 primary channel <sup>[a]</sup>	Gate 1 primary channel <sup>[a]</sup>	Gate1 secondary channel <sup>[a]</sup> (Channel B)
Measurement	Peak	Pk-to-Avg	Avg
<i>Lower window/lower measurement (LL)</i>			
Feed	Gate 1 primary channel <sup>[a]</sup>	Secondary channel <sup>[a]</sup>	Gate1 secondary channel <sup>[a]</sup> (Channel B)
Measurement	Pk-to-Avg	Avg	Pk-to-Avg

[a] For further information refer to "Primary and Secondary Channels" on page 473.

## DVB

The following table shows the power meter presets when `<character_data>` is set to **DVB**. Commands not listed are preset according to their **DEFault** values (for further information refer to [Table 12-1](#)).

**Table 12-47** DVB: Power meter presets

Command	Setting	Comments
<i>Frequency</i>		
[SENS[1]] SENS2:FREQ[:CW]:FIX]	<b>+660.000 MHz</b>	Frequency setting
<i>Sensor measurement mode</i>		
[SENS[1]] SENS2:DET:FUNC	<b>NORM</b>	Measurement mode
<i>Sensor video bandwidth setup</i>		
[SENS[1]] SENS2:BAND BWID:VID	<b>N1921/2A: OFF</b>	Sensor video bandwidth
<i>Gate Setup</i>		
[SENS[1]] SENS2:SWE[1] 2 3 4:OFF:TIME	<b>Gate 1: 10 <math>\mu</math>s Gate 2: 0 Gates 3 - 4: 0</b>	Delay between trigger point and time gated period.
[SENS[1]] SENS2:SWE[1] 2 3 4:TIME	<b>Gate 1: 15 ms Gate 1: 90 ms Gates 2 - 4: 0</b>	Length of time gated period for time gated measurements.
<i>Trigger setup</i>		
TRIG[:SEQ[1] 2]:SOUR	<b>INT1</b>	Trigger source set up and acquisition mode continuous triggering
INIT:CONT	<b>ON</b>	
TRIG[:SEQ]:LEV:AUTO	<b>OFF</b>	Disable automatic setting of the trigger level
TRIG[:SEQ]:LEV	<b>-15 dBm</b>	Power level
TRIG[:SEQ]:SLOP	<b>POS</b>	Trigger event recognized on the rising edge of a signal
TRIG[:SEQ]:DEL	<b>0 s</b>	Delay between recognition of trigger event and start of a measurement
TRIG[:SEQ]:HOLD	<b>20 ms</b>	Trigger holdoff

**Table 12-47** DVB: Power meter presets (continued)

Command	Setting	Comments
<i>Range<sup>[a]</sup></i>		
[SENS[1]] SENS2:POW:AC:RANG:AUTO	OFF	Auto range off
[SENS[1]] SENS2:POW:AC:RANG	UPPER	Range set to upper
<i>Step detection</i>		
[SENSe[1]] SENS2:AVER:SDET	1	Step detection enabled

[a] The Range setting in [Table 12-47](#) is only applicable for E-Series power sensor.

**Table 12-48** DVB: Power meter presets: Window/Measurement settings

Function	Setting	
	Single Channel	Dual Channel
<i>Display setup</i>		
Upper window	UU single numeric	See <a href="#">Table 12-49</a>
Lower window	Dual numeric	See <a href="#">Table 12-49</a>
<i>Window/measurement setup</i>		
<i>Upper window/upper measurement (UU)</i>		
Feed	Gate 1 Channel A	Gate 1 primary channel <sup>[a]</sup>
Measurement	Avg	Avg
<i>Upper window/lower measurement (UL)</i>		
Feed	DEF	See <a href="#">Table 12-49</a>
Measurement	DEF	See <a href="#">Table 12-49</a>
<i>Lower window/upper measurement (LU)</i>		
Feed	Gate 1 Channel A	See <a href="#">Table 12-49</a>
Measurement	Pk-to-Avg	See <a href="#">Table 12-49</a>
<i>Lower window/lower measurement (LL)</i>		

**Table 12-48** DVB: Power meter presets: Window/Measurement settings (continued)

Function	Setting	
	Single Channel	Dual Channel
Feed	Gate 2 Channel A	See <a href="#">Table 12-49</a>
Measurement	Avg	See <a href="#">Table 12-49</a>

[a] For further information refer to ["Primary and Secondary Channels"](#) on page 473.

**Table 12-49** DVB: Power meter presets for secondary channel sensors

Function	Secondary Channel Sensor		
	No Sensor	Non P-Series Sensor	P-Series Sensor
<i>Display setup</i>			
Upper window	UU single numeric	Dual numeric	Dual numeric
Lower window	Dual numeric	Dual numeric	Dual numeric
<i>Upper window/lower measurement (UL)</i>			
Feed	DEF	Gate 1 primary channel <sup>[a]</sup>	Gate 1 primary channel <sup>[a]</sup> (Channel A)
Measurement	DEF	Pk-to-Avg	Pk-to-Avg
<i>Lower window/upper measurement (LU)</i>			
Feed	Gate 1 primary channel <sup>[a]</sup>	Gate 2 primary channel <sup>[a]</sup>	Gate 1 secondary channel <sup>[a]</sup> (Channel B)
Measurement	Pk-to-Avg	Avg	Avg
<i>Lower window/lower measurement (LL)</i>			
Feed	Gate 2 primary channel <sup>[a]</sup>	Secondary channel <sup>[a]</sup>	Gate 1 secondary channel <sup>[a]</sup> (Channel B)
Measurement	Avg	Avg	Pk-to-Avg

[a] For further information refer to ["Primary and Secondary Channels"](#) on page 473.

## SYSTEM:VERSion?

This query returns the version of SCPI used in the power meter. The response is in the form of XXXX.Y, where XXXX is the year and Y is the version number.

### Syntax

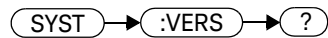

### Example

**SYST:VERS?**

*This command queries which version of SCPI is used in the power meter.*

THIS PAGE HAS BEEN INTENTIONALLY LEFT BLANK.



# 13 TRACe Subsystem

TRACe Subsystem	538
TRACe[1]2[:DATA]? <character_data>	540
TRACe[1]2:DEFine:DURation:REFerence <numeric_value>	542
TRACe[1]2:DEFine:TRANSition:REFerence <numeric_value>, <numeric_value>	544
TRACe[1]2:MEASurement:INSTant:REFerence? <numeric_value>	546
TRACe[1]2:MEASurement:PULSe[1]... 10:DURation?	548
TRACe[1]2:MEASurement:PULSe[1]... 10:PERiod?	550
TRACe[1]2:MEASurement:PULSe[1]... 10:SEParation?	552
TRACe[1]2:MEASurement:TRANSition[1]... 10:NEGative:DURation?	554
TRACe[1]2:MEASurement:TRANSition[1]... 10:NEGative:OCCurrence?	555
TRACe[1]2:MEASurement:TRANSition[1]... 10:POSitive:DURation?	556
TRACe[1]2:MEASurement:TRANSition[1]... 10:POSitive:OCCurrence?	557
TRACe[1]2:MEASurement:REFerence? <numeric_value>	558
TRACe[1]2:STATe <boolean>	560
TRACe[1]2:UNIT <character_data>	562

This chapter explains how to use the **TRACe** command subsystem to configure and read back the measured power trace.

## TRACe Subsystem

The **TRACe** subsystem is used to:

- Specify the type of trace to be captured.
- Enable/disable trace capture.
- Specify the trace units.

There are two pre-defined TRACE blocks:

- **TRACe1**: associated with Channel A
- **TRACe2**: associated with Channel B

The following commands are described in this chapter:

Keyword	Parameter Form	Notes	Page
<b>TRACe[1] 2</b>			
<b>[ :DATA ]?</b>	<b>&lt;character_data&gt;</b>	[query only]	<a href="#">page 540</a>
<b>:DEFine</b>			
<b>:DURation</b>			
<b>:REFerence</b>	<b>&lt;numeric_value&gt;</b>		<a href="#">page 542</a>
<b>:TRANSition</b>			
<b>:REFerence</b>	<b>&lt;numeric_value&gt;, &lt;numeric_value&gt;</b>		<a href="#">page 544</a>
<b>:MEASurement</b>			
<b>:INSTant</b>			
<b>:REFerence?</b>	<b>&lt;numeric_value&gt;</b>		<a href="#">page 546</a>
<b>:PULse[1] ... 10</b>			
<b>:DURation?</b>		[query only]	<a href="#">page 548</a>
<b>:PERiod?</b>		[query only]	<a href="#">page 550</a>
<b>:SEPAration?</b>		[query only]	<a href="#">page 552</a>
<b>:TRANSition[1] ... 10</b>			
<b>:NEGative</b>			

Keyword	Parameter Form	Notes	Page
	:DURation?	[query only]	page 554
	:OCCurrence?	[query only]	page 555
	:POSitive		
	:DURation?	[query only]	page 556
	:OCCurrence?	[query only]	page 557
	:REFerence?	<numeric_value>	page 558
:STATe	<boolean>		page 560
:UNIT	<character_data>		page 562

**NOTE**

When making trace measurements, use the following command sequence to synchronize the returned trace data with the measurement:

Command	Comment
<b>INIT:CONT OFF</b>	Trace data can only be retrieved with <b>INIT:CONT OFF</b>
<b>TRAC:STAT ON</b>	Enables trace capture
<b>AVER:STAT OFF</b> or <b>TRIG:DEL:AUTO OFF</b>	No settling time delays for digital filter to fill
<b>INIT</b>	Initiates a new measurement
<b>FETCH?</b>	Fetch the result (waits for the measurement to complete)
<b>TRACE:DATA? MRES</b>	Retrieves the trace data once the measurement has completed

## TRACe[1]|2[:DATA]? <character\_data>

This query returns trace data from the specified channel. The trace resolution is determined by <character\_data>.

Data is returned in IEEE 488.2 arbitrary block program data format as follows:

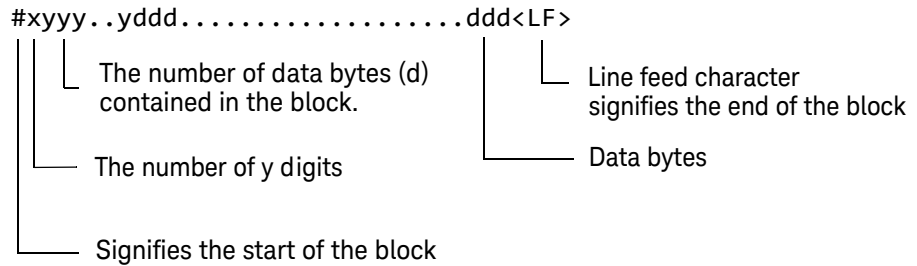

**Example:** if there are 12435 data bytes, y = 12435 and x = 5

Each point in the trace is represented as an IEEE 754 32 bit floating point number, made up of four bytes in the data block. The MS byte is transmitted first. Each complete block is terminated by a line feed.

**NOTE**

TRACe data formatting is not affected by FORMat subsystem formatting.

### Syntax

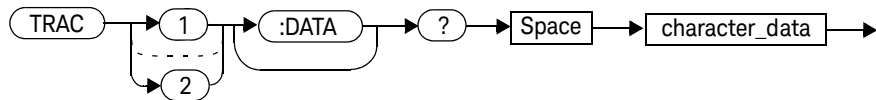

## Parameters

Item	Description/Default	Range of Values
character_data	<ul style="list-style-type: none"> <li>- <b>HRESolution</b>: high resolution. The complete capture buffer at the internal sample rate. The number of points in this trace is not fixed, as it is affected by the <b>SENS:TRACe:TIME</b> setting.</li> <li>- <b>MRESolution</b>: medium resolution. A subset of the capture buffer - the buffer contents are decimated<sup>1</sup> to 1000 data points.</li> <li>- <b>LRESolution</b>: low resolution. A subset of the capture buffer - the buffer contents are decimated<sup>1</sup> to provide 230 data points. This is the same number of data points as the power meter uses to display the trace on the front panel. Hence, the <b>LRES</b> command can be used to replicate the power meter's display.</li> </ul>	<b>HRES</b> <b>MRES</b> <b>LRES</b>

## Example

**TRAC:DATA? HRES**

*This command returns the trace data for Channel A at high resolution.*

## Error Messages

If **TRAC:STAT** is off, the error -221, "Settings Conflict" occurs.

## TRACe[1]|2:DEFine:DURation:REFerence<numeric\_value>

This command defines the reference levels to be used in the calculation of pulse durations. This allows pulse duration measurements between non-standard reference levels. This is a configuration command independent of the sensors.

### Syntax

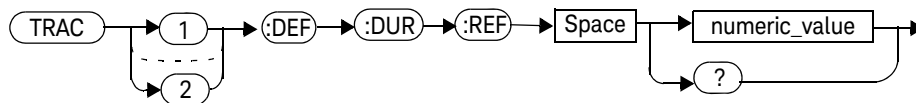

### Parameters

Item	Description/Default	Range of Values
numeric_value	Reference levels to be used in calculation of pulse duration	0 to 100 DEF

## Example

**TRAC1:DEF:DUR:REF 25**

*This command sets trace 1 pulse duration measurements to look for the 25 % reference levels.*

**TRAC1:DEF:DUR:REF DEF**

*This command sets trace 1 pulse duration measurements to look for the 50 % reference levels.*

## Reset condition

On reset, the reference level will become 50 %, which is the default value (DEF).

## Query

**TRACe[1]|2:DEFine:DURation:REFerence?**

The query returns the numeric value of the reference level used in the pulse duration calculation.

## Query Example

**TRAC1:DEF:DUR:REF?**

*This command queries the value of the reference level used in pulse duration measurement for trace 1.*

TRACe[1]|2:DEFine:TRANSition:REFerence <numeric\_value>, <numeric\_value>

This command defines the reference levels to be used in the calculation of transition durations and occurrences. This allows transition measurements between non-standard reference levels and it is a configuration command that independent of sensors.

### Syntax

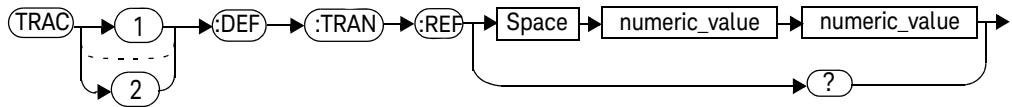

### Parameters

Item	Description/Default	Range of Values
numeric_value	Reference levels to be used in calculation of transition durations and occurrences	0 to 100 DEF



## Example

**TRAC1:DEF:TRAN:REF 1,18**

*This command sets trace 1 transition measurements to look for the 1 % and 81 % reference levels.*

**TRAC1:DEF:TRAN:REF DEF,DEF**

*This command sets trace 1 transition measurements to look for the 10 % and 90 % reference levels.*

## Reset Condition

On reset, the reference level will set to 10 % and 90 % respectively.

## Query

**TRACe[1]|2:DEFine:TRANSition:REFerence?**

The query returns trace 1 reference levels used in the transition occurrences calculation.

## Query Example

**TRAC1:DEF:TRAN:REF?**

*This command queries the reference levels used in the calculation of transition durations and occurrences for trace 1.*

## TRACe[1]|2:MEASurement:INSTant:REFerence? <numeric\_value>

This command returns the time instant at which the power waveform intersects the reference level supplied as the command parameter. This allows the time instant used to calculate the pulse parameters to be found. It also allows calculation of transition between non-standard reference levels.

### NOTE

This command is only applicable when P-Series power sensors are used with single or continuous triggered acquisition is selected.

### Syntax

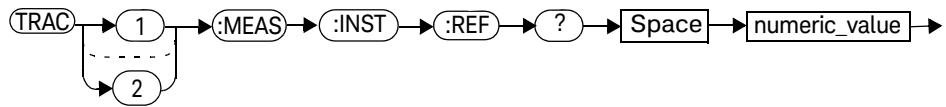

### Parameters

Item	Description/Default	Range of Values
numeric_value	Reference level in percentage	-25 to 125

## Example

**TRAC1:MEAS:INST:REF? 25**

*This command return the time instant for trace 1 when the power transitioned through 25 % reference level.*

## Error Messages

- If P-Series power sensor is not present, the error -241, "Hardware Missing" occurs.

## TRACe[1]|2:MEASurement:PULSe[1]|...|10:DURation?

This command returns the difference between a pulse and next transition occurrence instants. As power pulses are by definition positive pulses, the pulse duration is the time difference between positive and negative transitions of one pulse.

### Algorithm

If the first transition in the trace is positive,  
then

**PULSe:DURation** = *time the first negative transition occurs - time the first positive transition occurs*

else

**PULSe:DURation** = *time the second negative transition occurs - time the first positive transition occurs.*

### Syntax

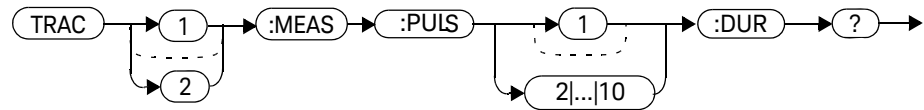

### Example

**TRAC2:MEAS:PULS3:DUR?**

*This command returns the duration of the 3rd pulse found on trace 2.*

## Error Messages

- If a P-Series sensor is not connected, error -241, “Hardware missing” occurs.
- If a P-Series sensor is connected and **Free Run** trigger acquisition is selected, error -221, “Settings conflict” occurs.

**NOTE**

If you attempt to measure a pulse out of the range of the capture, for example, measure the 5th pulse and there are only 4 pulses displayed, the power meter returns #0##9.91E37 as the result.

---

## TRACe[1]|2:MEASurement:PULSe[1]|...|10:PERiod?

This command returns the pulse period. This is the time difference between two consecutive transition occurrences of the same polarity. The period is equal to the sum of the pulse separation and the pulse duration.

### Algorithm

If the first transition in the trace is positive,  
then

**PULSe:PERiod** = *time the second positive transition occurrence - time the first positive transition occurs*

else

**PULSe:PERiod** = *time the second negative transition occurs - time the first negative transition occurs.*

### Syntax

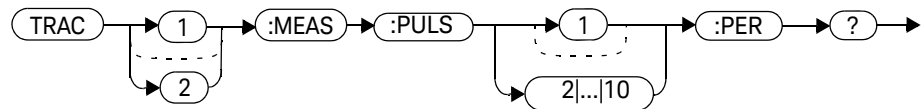

### Example

**TRAC:MEAS:PULS:PER?**

*This command returns the period of the pulse found on trace 1.*

## Error Messages

- If a P-Series sensor is not connected, error -241, “Hardware missing” occurs.
- If a P-Series sensor is connected and **Free Run** trigger acquisition is selected, error -221, “Settings conflict” occurs.

**NOTE**

If you attempt to measure a pulse out of the range of the capture, for example, measure the 5th pulse and there are only 4 pulses displayed, the power meter returns #0##9.91E37 as the result.

---

## TRACe[1]|2:MEASurement:PULSe[1]|...|10:SEParation?

This command returns the time difference of the  $n^{\text{th}}$  and  $(n+1)^{\text{th}}$  pulses found on a trace. As power pulses are by definition positive pulses, the pulse separation is the time difference between negative transition of one pulse and the positive transition of the next pulse.

### Algorithm

If the first transition in the trace is positive,  
then

**PULSe:SEParation** = *time the second positive transition occurs - time the first negative transition occurs*

else

**PULSe:SEParation** = *time the first positive transition occurs - time the first negative transition occurs.*

### Syntax

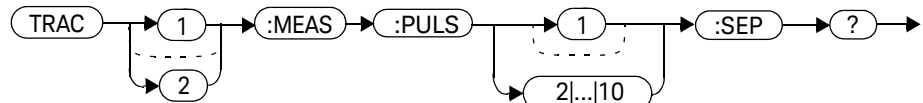

### Example

**TRAC1:MEAS:PULS:SEP?**

*This command returns the time separation of the 1st and 2nd pulses found on trace 1.*



## Error Messages

- If a P-Series sensor is not connected, error -241, “Hardware missing” occurs.
- If a P-Series sensor is connected and **Free Run** trigger acquisition is selected, error -221, “Settings conflict” occurs.

**NOTE**

If you attempt to measure a pulse out of the range of the capture, for example, measure the 5th pulse and there are only 4 pulses displayed, the power meter returns #0##9.91E37 as the result.

---

## TRACe[1]]2:MEASurement:TRANSition[1]]...|10:NEGative:DURation?

This command returns the  $n^{\text{th}}$  negative transition duration found on a trace.

### Syntax

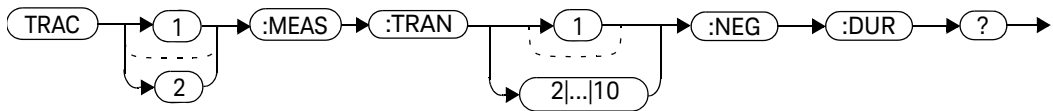

### Reset Condition

On reset, this parameter is not affected.

### Example

**TRAC:MEAS:TRAN8:NEG:DUR?**

*This command returns the 8th negative transition duration found on trace 1.*

### Error Messages

- If a P-Series sensor is not connected, error –241, “Hardware missing” occurs.
- If a P-Series sensor is connected and **Free Run** trigger acquisition is selected, error –221, “Settings conflict” occurs.

#### NOTE

If you attempt to measure a pulse out of the range of the capture, for example, measure the 5th pulse and there are only 4 pulses displayed, the power meter returns #0#0#0 as the result.

## TRACe[1]|2:MEASurement:TRANSition[1]...|10:NEGative:OCCurrence?

This command returns the position, relative to the trigger instant, of the  $n^{\text{th}}$  occurrence of a negative transition found on a trace.

### Syntax

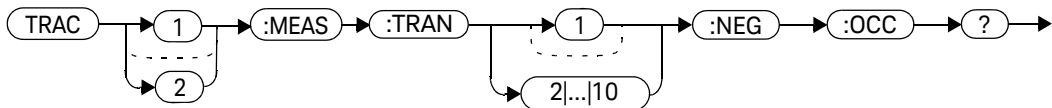

### Reset Condition

On reset, this parameter is not affected.

### Example

**TRAC2:MEAS:TRAN7:NEG:OCC?**

*This command returns the position, relative to the trigger instant, of the 7th occurrence of a negative transition found on trace 2.*

### Error Messages

- If a P-Series sensor is not connected, error -241, "Hardware missing" occurs.
- If a P-Series sensor is connected and **Free Run** trigger acquisition is selected, error -221, "Settings conflict" occurs.

#### NOTE

If you attempt to measure a pulse out of the range of the capture, for example, measure the 5th pulse and there are only 4 pulses displayed, the power meter returns #0#0#0 as the result.

## TRACe[1]|2:MEASurement:TRANSition[1]|...|10:POSitive:DURation?

This command returns the  $n^{\text{th}}$  positive transition duration found on a trace.

### Syntax

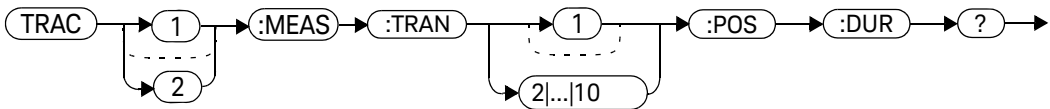

### Reset Condition

On reset, this parameter is not affected.

### Example

**TRAC:MEAS:TRAN10:POS:DUR?**

*This command returns the 10th positive transition duration found on trace 1.*

### Error Messages

- If a P-Series sensor is not connected, error -241, “Hardware missing” occurs.
- If a P-Series sensor is connected and Free Run trigger acquisition is selected, error -221, “Settings conflict” occurs.

#### NOTE

If you attempt to measure a pulse out of the range of the capture, for example, measure the 5th pulse and there are only 4 pulses displayed, the power meter returns #0#0#0 as the result.

## TRACe[1]|2:MEASurement:TRANSition[1]|...|10:POSitive:OCCurrence?

This command returns the position, relative to the trigger instant, of the  $n^{\text{th}}$  occurrence of a positive transition found on a trace.

### Syntax

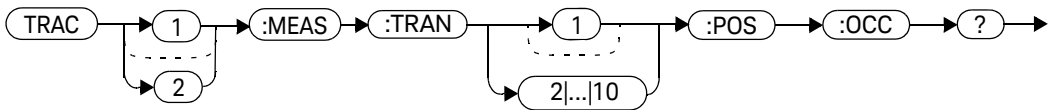

### Reset Condition

On reset, this parameter is not affected.

### Example

**TRAC2:MEAS:TRAN:POS:OCC?**

*This command returns the position, relative to the trigger instant, of the 1st occurrence of a positive transition found on trace 2.*

### Error Messages

- If a P-Series sensor is not connected, error -241, "Hardware missing" occurs.
- If a P-Series sensor is connected and Free Run trigger acquisition is selected, error -221, "Settings conflict" occurs.

#### NOTE

If you attempt to measure a pulse out of the range of the capture, for example, measure the 5th pulse and there are only 4 pulses displayed, the power meter returns #0#0#0 as the result.

## TRACe[1]|2:MEASurement:REFerence? <numeric\_value>

This command is used to find the reference power level. This provides the reference power level to calculate the pulse parameters.

Commonly used reference levels are 0 %, 10 %, 50 %, 90 %, and 100 %. You can set the reference level to measure overshoot at 125 % and undershoot at -25 %.

### Algorithm

$$P_{x\%} = P_{0\%} + x/100 (P_{100\%} - P_{0\%})$$

where:

- 0 % <= x <= 100 %
- P<sub>0%</sub> = level of low state
- P<sub>100%</sub> = level of high state
- P<sub>0%</sub>, P<sub>100%</sub> and P<sub>x%</sub> are all in the same unit of measurement, for example, Watts.

### Syntax



### Reset Condition

On reset, this parameter is not affected.

## Example

**TRAC2:MEAS:REF? 100**

*This command returns the high state power for trace 2.*

## Error Messages

- If a P-Series sensor is not connected, error -241, “Hardware missing” occurs.
- If a P-Series sensor is connected and **Free Run** trigger acquisition is selected, error -221, “Settings conflict” occurs.

## TRACe[1]|2:STATe <boolean>

This command enables or disables trace capture for the specified channel.

### Syntax

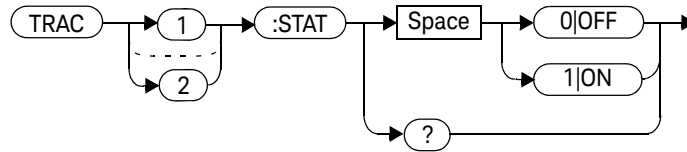

### Example

**TRAC2:STAT 1**

*This command enables trace capture for Channel B.*

### Reset Condition

On reset trace capture is set to OFF.

### Query

**TRACe[1]|2:STATe?**

The query command enters a 1 or 0 into the output buffer indicating whether or not trace capture is enabled or disabled.

- 1 is returned when trace capture is enabled
- 0 is returned when trace capture is disabled



## Query Example

**TRAC1:STAT?**

*This command queries the current state of trace capture for Channel A.*

## Error Messages

- If a P-Series sensor is not connected, error –241, “Hardware missing” occurs.

## TRACe[1]|2:UNIT &lt;character\_data&gt;

This command sets the units for the trace for the specified channel

**NOTE**

This command is included for compatibility purposes only. It has the same purpose as [SENSe[1]]|SENSe2:TRACe:UNIT <character\_data>, which should be the preferred command.

## Syntax

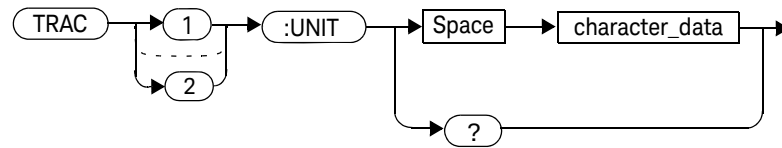

## Parameters

Item	Description/Default	Range of Values
character_data	- DBM: dBm - W: Watts	DBM W

## Example

TRAC2:UNIT W

*This command sets the trace units for Channel B Watts.*

## Reset Condition

On reset the units are set to dBm.

## Query

**TRACe[1]|2:UNIT?**

The query command returns the current value of character\_data.

## Query Example

**TRAC2:UNIT?**

*This command queries the current trace units for Channel B.*

THIS PAGE HAS BEEN INTENTIONALLY LEFT BLANK.

# 14 TRIGger Subsystem

TRIGger Subsystem	566
ABORT[1] 2	568
INITiate Commands	569
INITiate[1] 2:CONTInuous <boolean>	570
INITiate[1] 2[:IMMEDIATE]	572
INITiate:CONTInuous:ALL <boolean>	573
INITiate:CONTInuous:SEQuence[1] 2 <boolean>	575
INITiate[:IMMEDIATE]:ALL	577
INITiate[:IMMEDIATE]:SEQuence[1] 2	578
TRIGger Commands	579
TRIGger[1] 2:DELay:AUTO <boolean>	580
TRIGger[1] 2[:IMMEDIATE]	582
TRIGger[1] 2:SOURce BUS EXTErnal HOLD IMMEDIATE INTErnal[[1] 2]	583
TRIGger[:SEQuence]:DELay <numeric_value>	586
TRIGger[:SEQuence]:HOLDoff <numeric_value>	588
TRIGger[:SEQuence]:HYSTEResis <numeric_value>	590
TRIGger[:SEQuence]:LEVel <numeric_value>	592
TRIGger[:SEQuence]:LEVel:AUTO <boolean>	594
TRIGger[:SEQuence]:SLOPe <character_data>	596
TRIGger[:SEQuence[1] 2]:COUNT <numeric_value>	597
TRIGger[:SEQuence[1] 2]:DELay:AUTO <boolean>	599
TRIGger[:SEQuence[1] 2]:IMMEDIATE	601
TRIGger[:SEQuence[1] 2]:SOURce BUS EXTErnal HOLD IMMEDIATE INTErnal[[1] 2]	602

This chapter explains how the **TRIGger** command subsystem is used to synchronize device actions with events.

## TRIGger Subsystem

The **TRIGger** subsystem is used to synchronize device actions with events. It includes the **ABORT**, **INITiate** and **TRIGger** commands. These are all at the root level in the command hierarchy but they are grouped here because of their close functional relationship.

Keyword	Parameter Form	Notes	Page
ABORT[1] 2		[no query] [non-SCPI]	<a href="#">page 568</a>
INITiate[1] 2			
:CONTinuous	<boolean>		<a href="#">page 570</a>
[:IMMediate]		[no query]	<a href="#">page 572</a>
INITiate			
:CONTinuous			
:ALL	<boolean>		<a href="#">page 573</a>
:SEQuence[1] 2	<boolean>		<a href="#">page 575</a>
[:IMMediate]			
:ALL		[no query]	<a href="#">page 577</a>
:SEQuence[1] 2		[no query]	<a href="#">page 578</a>
TRIGger[1] 2			
:DELay			
:AUTO	<boolean>		<a href="#">page 580</a>
[:IMMediate]		[no query]	<a href="#">page 582</a>
:SOURce	BUS EXTernal HOLD  IMMediate INTernal[[1] 2]		<a href="#">page 583</a>
TRIGger			
[:SEQuence]			
:DELay	<numeric_value>		<a href="#">page 586</a>
:HOLDoff	<numeric_value>		<a href="#">page 588</a>

Keyword	Parameter Form	Notes	Page
:HYSTeresis	<numeric_value>		<a href="#">page 590</a>
:LEVe1	<numeric_value>		<a href="#">page 592</a>
:AUTO	<boolean>		<a href="#">page 594</a>
:SLOPe	<character_data>		<a href="#">page 596</a>
[:SEQuence[1] 2]			
:COUNt	<numeric_value>		<a href="#">page 597</a>
:DELay			
:AUTO	<boolean>		<a href="#">page 599</a>
:IMMediate		[no query]	<a href="#">page 601</a>
:SOURce	BUS EXTeRnal HOLD  IMMediate INTeRnal[[1] 2]		<a href="#">page 602</a>

Many of the above commands contain a numeric which represents a channel number. For example **TRIGger1** and **TRIGger2** represent Channel A and Channel B respectively.

## ABORt[1]|2]

This command removes the specified channel from the wait for trigger state and places it in the idle state. It does not affect any other settings of the trigger system. When the **INITiate** command is sent, the trigger system responds as it did before **ABORt** was executed.

If **INITiate:CONTinuous** is **ON**, then after **ABORt** the specified channel immediately goes into the wait for trigger state.

### Syntax

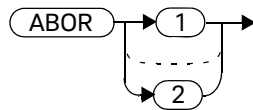

### Example

**ABOR**

*This command places Channel A in the idle state.*



## INITiate Commands

Initiate commands allow you to place the power meter in the wait for trigger state.

The **INITiate** commands are overlapped, that is, the power meter can continue parsing and executing subsequent commands while initiated. Note that the pending operation flag is set, when the power meter enters an idle state and the flag is cleared when it re-enters the idle state.

The following commands are described in this section:

```
INITiate[1]|2:CONTinuous <boolean>
```

```
INITiate[1]|2[:IMMediate]
```

```
INITiate:CONTinuous:ALL <boolean>
```

```
INITiate:CONTinuous:SEquence[1]|2 <boolean>
```

```
INITiate[:IMMediate]:ALL
```

```
INITiate[:IMMediate]:SEquence[1]|2
```

## INITiate[1]|2:CONTinuous <boolean>

This command sets the power meter for either a single trigger cycle or continuous trigger cycles. A trigger cycle means that the power meter exits the wait for trigger state and starts a measurement.

When entering local mode, if **TRIGger[:SEquence[1]|2]:SOURce** is set to **INT[1]|2** or **EXT**, **INITiate:CONTinuous** is not changed. For other trigger sources, **INITiate:CONTinuous** is set to **ON**.

If **INITiate:CONTinuous** is set to:

- **OFF**, the trigger system remains in the idle state until it is set to **ON**, or **INITiate:IMMediate** is received. Once this trigger cycle is complete the trigger system returns to the idle state.
- **ON**, the trigger system is initiated and exits the idle state. On completion of each trigger cycle, the trigger system immediately commences another trigger cycle without entering the idle state.

### NOTE

This command performs the same function as **INITiate:CONTinuous:SEquence[1]|2 <boolean>**.

### Syntax

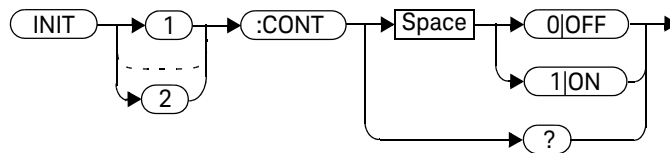

## Example

**INIT2:CONT ON**

*This command places Channel B in the wait for trigger state.*

## Reset Condition

On reset (\*RST), this command is set to **OFF**.

On preset (SYSTem:PRESet) and instrument power-up, when entering local mode, if TRIGger[:SEQuence[1]|2]:SOURce is set to INT[[1]|2] or EXT, INITiate:CONTinuous is not changed. For other trigger sources, INITiate:CONTinuous is set to **ON**.

## Query

**INITiate[1]|2:CONTinuous?**

The query enters a 1 or 0 into the output buffer.

- 1 is returned when there is continuous triggering
- 0 is returned when there is only a single trigger

## Query Example

**INIT2:CONT?**

*This command queries whether Channel B is set for single or continuous triggering.*

## INITiate[1]|2[:IMMEDIATE]

This command sets the power meter in the wait for trigger state. When a trigger is received, the measurement is taken and the result placed in the power meter memory. If **TRIGger:SOURce** is set to **IMMEDIATE** the measurement begins as soon as **INITiate:IMMEDIATE** is executed.

Use **FETCh?** to transfer a measurement from memory to the output buffer. Refer to “**FETCh[1]|2|3|4 Queries**” on page 145 for further details.

### NOTE

This command performs the same function as **INITiate:[IMMEDIATE]:SEquence[1]|2**.

### Syntax

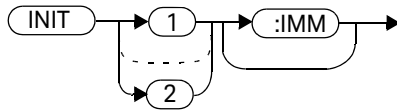

### Example

**INIT2:IMM**

*This command places Channel B in the wait for trigger state.*

### Error Messages

If the power meter is not in the idle state or **INITiate:CONTinuous** is **ON**, error -213, “INIT ignored” occurs.

## INITiate:CONTInuous:ALL <boolean>

Sets all trigger sequences to be continuously initiated.

If **INITiate:CONTInuous:ALL** is set to:

- **ON**, trigger sequences are set to be continuously initiated
- **OFF**, trigger sequences are not set to be continuously initiated

### Syntax

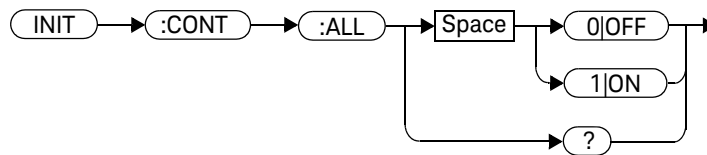

### Example

**INIT:CONT:ALL ON**

*This command sets all trigger sequences to be continuously initiated.*

### Reset Condition

On reset (**\*RST**), this command is set to **OFF**.

On preset (**SYSTem:PRESet**) and instrument power-up, when entering local mode, if **TRIGger[:SEQuence[1]|2]:SOURce** is set to **INT[[1]|2]** or **EXT**, **INITiate:CONTInuous** is not changed. For other trigger sources, **INITiate:CONTInuous** is set to **ON**.

## Query

### **INITiate:CONTInuous:ALL?**

The query enters a 1 or 0 into the output buffer.

- 1 is returned when trigger sequences are set to be continuous
- 0 is returned when trigger sequences are not set to be continuous

## Query Example

### **INIT:CONT:ALL?**

*This command queries whether both channels are in a wait for trigger state.*

## INITiate:CONTInuous:SEQuence[1]|2 <boolean>

This command sets the power meter for either a single trigger cycle or continuous trigger cycles. A trigger cycle means that the power meter exits the wait for trigger state and starts a measurement. When entering local mode, **INITiate:CONTInuous** is set to **ON**.

If **INITiate:CONTInuous:SEQuence[1|2] <boolean>** is set to:

- **OFF**, the trigger system remains in the idle state until it is set to **ON**, or **INITiate:IMMediate** is received. Once this trigger cycle is complete the trigger system returns to the idle state.
- **ON**, the trigger system is initiated and exits the idle state. On completion of each trigger cycle, the trigger system immediately commences another trigger cycle without entering the idle state.

### NOTE

This command performs the same functions as **INITiate[1]|2:CONTInuous <boolean>**.

### Syntax

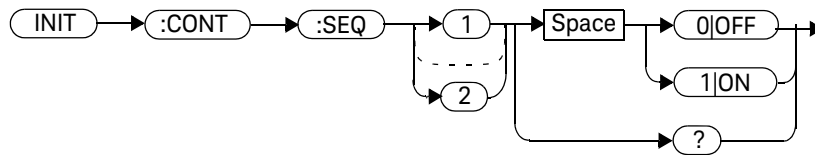

### Example

**INIT:CONT:SEQ2 ON**

*This command places Channel B in a wait for trigger state.*

## Reset Condition

On reset (**\*RST**), this command is disabled.

On preset (**SYSTem:PRESet**) and instrument power-up, this command is enabled.

## Query

**INITiate[1]|2:CONTinuous:SEquence?**

The query enters a 1 or 0 into the output buffer.

- 1 is returned when there is continuous triggering
- 0 is returned when there is only a single trigger

## Query Example

**INIT2:CONT:SEQ?**

*This command queries whether Channel B is set for single or continuous triggering.*



## INITiate[:IMMediate]:ALL

This command initiates all trigger sequences.

### Syntax

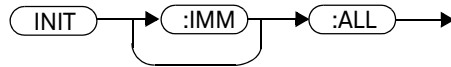

### Example

**INIT:IMM:ALL**

*This command initiates all trigger sequences.*

### Error Messages

If the power meter is not in the idle state or **INITiate:CONTinuous** is **ON**, error -213, "INIT ignored" occurs.

## INITiate[:IMMEDIATE]:SEQUENCE[1]|2

This command sets the power meter in the wait for trigger state. When a trigger is received, the measurement is taken and the result placed in the power meter memory. If **TRIGger:SOURce** is set to **IMMEDIATE** the measurement begins as soon as **INITiate:IMMEDIATE** is executed.

Use **FETCh?** to transfer a measurement from memory to the output buffer. Refer to “**FETCh[1]|2|3|4 Queries**” on page 145 for further information.

### NOTE

This command performs the same function as **INITiate[1] | 2:[IMMEDIATE]**.

### Syntax

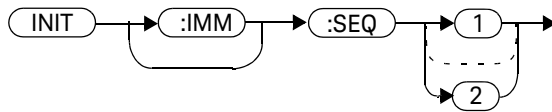

### Example

**INIT:IMM:SEQ1**

*This command places Channel A in the wait for trigger state.*

### Error Messages

If the power meter is not in the “idle” state or **INITiate:CONTinuous** is **ON**, error -213, “INIT ignored” occurs.

## TRIGger Commands

TRIGger commands control the behavior of the trigger system.

The following commands are described in this section:

```

TRIGger[1]|2:DELAy:AUTO <boolean>
TRIGger[1]|2:SOURce BUS|IMMediate|HOLD
TRIGger[1]|2[:IMMediate]
TRIGger[:SEQuence]:DELAy <numeric_value>
TRIGger[:SEQuence]:HOLDoff <numeric_value>
TRIGger[:SEQuence]:HYSTeresis <numeric_value>
TRIGger[:SEQuence]:LEVel <numeric_value>
TRIGger[:SEQuence]:LEVel:AUTO <boolean>
TRIGger[:SEQuence]:SLOPe <character_data>
TRIGger[:SEQuence[1]|2]:COUNT <numeric_value>
TRIGger[:SEQuence[1]|2]:DELAy:AUTO <boolean>
TRIGger[:SEQuence[1]|2]:IMMediate
TRIGger[:SEQuence[1]|2]:SOURce
BUS|EXTErnal|HOLD|IMMediate|INTernAl[[1]|2

```

## TRIGger[1]|2:DElay:AUTO <boolean>

This command is used to determine whether or not there is a settling-time delay before a measurement is made.

When this command is set to:

- **ON**, the power meter inserts a settling-time delay before taking the requested measurement. This settling time allows the internal digital filter to be updated with new values to produce valid, accurate measurement results. The trigger with delay command allows settling time for the internal amplifiers and filters. It does not allow time for power sensor delay.

In cases of large power changes, the delay may not be sufficient for complete settling. Accurate readings can be assured by taking two successive measurements for comparison.

- **OFF**, the power meter makes the measurement immediately a trigger is received.

TRIGger[1]|2:DElay:AUTO is ignored if TRIGger[1]|2[:IMMediate] is used to trigger the power meter.

### Syntax

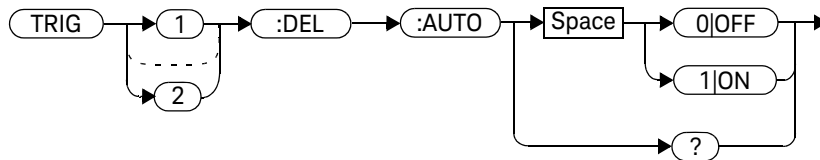

## Example

**TRIG:DEL:AUTO ON**

*This command enables a delay on Channel A.*

## Reset Condition

On reset, **TRIGger:DELay:AUTO** is set to **ON**.

## Query

**TRIGger:DELay:AUTO?**

The query enters a 1 or 0 into the output buffer indicating the status of **TRIGger:DELay:AUTO**.

- 1 is returned when it is **ON**
- 0 is returned when it is **OFF**

## TRIGger[1]|2[:IMMediate]

This command causes a trigger to occur immediately, provided the specified channel is in the wait for trigger state. When this command is executed, the measurement result is stored in the power meter's memory. Use **FETCh?** to place the measurement result in the output buffer.

**TRIGger[1]|2:DELay:AUTO** is ignored if **TRIGger[1]|2[:IMMediate]** is used to trigger the power meter.

### NOTE

This command performs the same function as **INITiate[1]|2[:IMMediate]**.

### Syntax

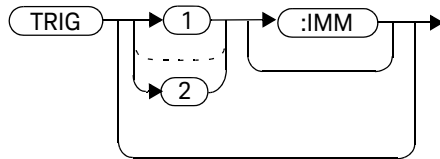

### Example

**TRIG**

*This command causes a Channel A trigger to occur immediately.*

### Error Messages

If the power meter is not in the wait for trigger state, then **TRIGger:IMMediate** causes error -211, "Trigger ignored".

## TRIGger[1]|2:SOURce BUS|EXTernal|HOLD|IMMEDIATE|INTernal[[1]|2]

This command configures the trigger system to respond to the specified source. This command only selects the trigger source. Use the **INITiate** command to place the power meter in the wait for trigger state.

### NOTE

This command has been included for compatibility purposes. It has the same purpose as TRIGger[:SEquence[1]|2]:SOURce BUS|EXTernal|HOLD|IMMEDIATE|INTernal[[1]|2] which should be used in preference.

### Syntax

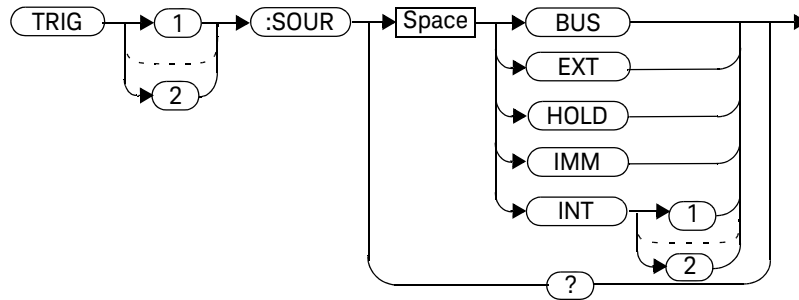

## Parameters

Item	Description/Default	Range of Values
source	<ul style="list-style-type: none"> <li>- Available trigger sources:</li> <li>- <b>BUS</b>: the trigger source is the group execute trigger <code>&lt;GET&gt; bus</code> command, a <code>*TRG</code> common command or the <code>TRIGGER:IMMEDIATE</code> SCPI command.</li> <li>- <b>EXternal</b>: the trigger source is the trigger input in the front panel.</li> <li>- <b>HOLD</b>: triggering is suspended. The only way to trigger the power meter is to use <code>TRIGGER:IMMEDIATE</code>.</li> <li>- <b>IMMEDIATE</b>: the trigger system is always true. If <code>INITiate:CONTinuous</code> is <b>ON</b> the power meter is continually triggering free (free run mode). If an <code>INITiate:IMMEDIATE</code> command is sent a measurement is triggered then the power meter returns to the idle state.</li> <li>- <b>INTERNAL</b>: either INT1 (Channel A) or INT2 (Channel B).</li> </ul>	<b>BUS</b> <b>EXternal</b> <b>HOLDIMMEDIATE</b> <b>INTERNAL[[1] 2]</b>

### NOTE

The trigger source is set to **IMMEDIATE** on instrument power-up and when entering local mode.

The `MEASURE` and `CONFIGURE` commands automatically set the trigger source to **IMMEDIATE**.

The `READ?` or `MEASURE` commands should not be used if the trigger source is set to **BUS** or **HOLD**.

## Example

```
TRIG:SOUR IMM
```

*This command configures Channel A for immediate triggering.*

## Reset Condition

On reset, the trigger source is set to **IMMEDIATE**.



## Query

**TRIGger:SOURce?**

The query returns the current trigger source, either **IMM**, **BUS** or **HOLD**.

## Query Example

**TRIG:SOUR?**

*This command queries Channel A's trigger source.*

## Error Messages

- If the leader is changed to **IMM**, **BUS** or **HOLD**, error -221 "Settings Conflict" occurs. In such situations the follower's **TRIG:SOUR** must be changed so that it is no longer a follower.
- If the source is changed to **INT1**, **INT2** or **EXT** and **SENS:SPEED** has a value of 200, error -221 "Settings Conflict" occurs.
- If the source is changed to **INT1**, **INT2** or **EXT** and **SENS:DET:FUNC** is set to **AVERAge**, error -221 "Settings Conflict" occurs.

## TRIGger[:SEquence]:DELay &lt;numeric\_value&gt;

This command sets the delay between the recognition of a trigger event and the start of a measurement.

## Syntax

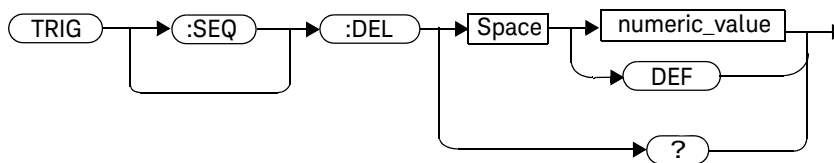

## Parameters

Item	Description/Default	Range of Values
numeric_value	The delay between the recognition of a trigger event and the start of the measurement. – <b>DEF</b> : the default value is 0 seconds Units are resolved to 1.25 ns.	–1 to 1 second <b>DEF</b>

## Example

**TRIG:SEQ:DEL 0.001**

*This command sets a delay of 1 ms for Channel A.*

## Reset Condition

On reset, the trigger delay is set to 0 seconds.

## Query

**TRIGger[:SEQuence]:DELay?**

The query returns the current setting of the trigger delay.

## Query Example

**TRIG:SEQ:DEL?**

*This command queries the trigger delay of Channel A.*

## Reset Condition

On reset, trigger delay is set to 0 seconds.

## TRIGger[:SEquence]:HOLDOff &lt;numeric\_value&gt;

This command sets the trigger holdoff in seconds.

## Syntax

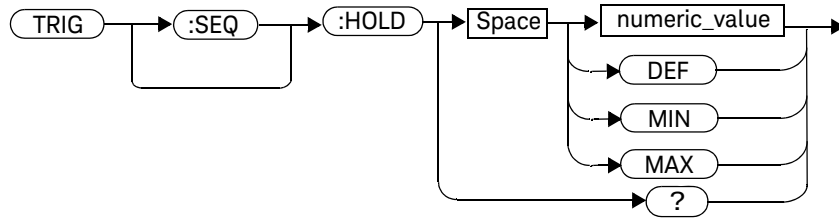

## Parameters

Item	Description/Default	Range of Values
numeric_value	The trigger holdoff in seconds. - <b>DEF</b> : the default value is 1 $\mu$ s - <b>MIN</b> : 1 $\mu$ s - <b>MAX</b> : 400 ms Units are resolved to 1 ns.	1 $\mu$ s to 0.4 seconds <b>DEF</b> <b>MIN</b> <b>MAX</b>

## Example

**TRIG:SEQ1:HOLD 0.1**

*This command sets the trigger holdoff to 100 ms for Channel A.*

## Reset Condition

On reset the trigger holdoff is set to 1  $\mu$ s.

## Query

**TRIGger[:SEQuence]:HOLDoff?**

The query returns the current trigger holdoff setting.

## Query Example

**TRIG:SEQ:HOLD?**

*This command queries the trigger holdoff setting for Channel A.*

## TRIGger[:SEQuence]:HYSTeresis &lt;numeric\_value&gt;

This command sets:

- How far a signal must fall below **TRIG:LEVe1** before a rising edge can be detected.
- How far a signal must rise above **TRIG:LEVe1** before a falling edge can be detected.

## Syntax

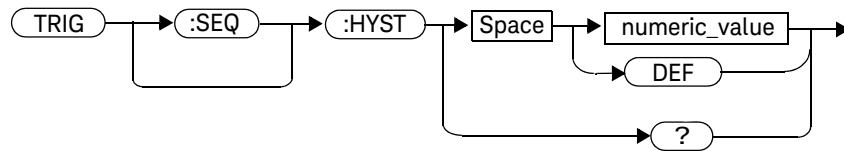

## Parameters

Item	Description/Default	Range of Values
numeric_value	How far a signal must fall/rise before a rising or falling edge can be detected. - <b>DEF</b> : the default value is 0 dB Units are resolved to 0.05 dB.	0 to 3 dB <b>DEF</b>

## Example

**TRIG:SEQ:HYST 0.1**

*This command sets the value to 2 dB for Channel A.*

## Reset Condition

On reset the value is set to 0 dB.

## Query

**TRIGger[:SEQuence]:HYSTeresis?**

The query returns the current value in dB.

## Query Example

**TRIG:SEQ:HYST?**

*This command queries the value for Channel A.*

## TRIGger[:SEquence]:LEVel <numeric\_value>

This command sets the power level at which a trigger event is recognized.

### Syntax

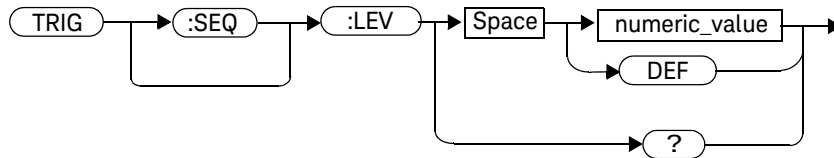

### Parameters

Item	Description/Default	Range of Values <sup>[a]</sup>
numeric_value	The power level at which a trigger event is recognized. – DEF: the default value is 0 dBm Units are resolved to 0.1 dBm.	–40 to 20 dBm DEF

[a] If a channel offset has been previously set, a higher numeric value is permitted. See "Setting Offsets" on page 88 for more information.

### Example

**TRIG:SEQ:LEV 10**

*This command sets the power level for a trigger event to 10 dBm.*

### Reset Condition

On reset the power level is set to 0 dBm.



## Query

**TRIGger[:SEquence]:LEVel?**

The query returns the current power level setting.

## Query Example

**TRIG:SEQ1:LEV?**

*This command queries the power level setting for Channel A.*

## TRIGger[:SEQuence]:LEVel:AUTO &lt;boolean&gt;

This command enables/disables automatic setting of the trigger level.

When this command is set to:

- **ON**, automatic setting of the trigger level is enabled.
- **OFF**, automatic setting of the trigger level is disabled.
- **ONCE**, automatic setting of the trigger level is enabled for one trigger event only. The value is then set to **OFF**.

## Syntax

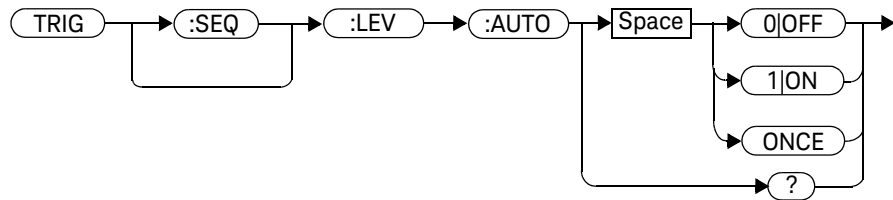

## Example

**TRIG:SEQ:LEV:AUTO 0**

*This command disables the automatic setting of the trigger level for Channel A.*

## Reset Condition

On reset the value is set to **ON**.

## Query

**TRIGger[:SEquence]:LEVe1:AUTO?**

The query enters a 1 or 0 into the output buffer indicating the status of **TRIGger[:SEquence]:LEVe1:AUTO**.

- 1 is returned when it is **ON**
- 0 is returned when it is **OFF**

## Query Example

**TRIG:SEQ:LEV:AUTO?**

*This command queries the setting for Channel A.*

## TRIGger[:SEQuence]:SLOPe &lt;character\_data&gt;

This command specifies whether a trigger event is recognized on the rising or falling edge of a signal.

## Syntax

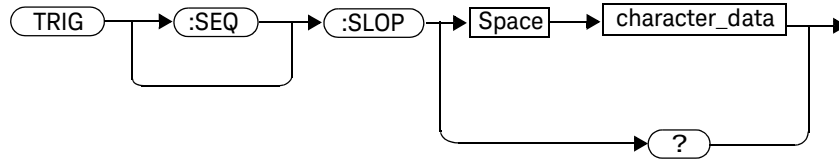

## Parameters

Item	Description/Default	Range of Values
character_data	How a trigger event is recognized: – <b>POSitive</b> : a trigger event is recognized on the rising edge of a signal. – <b>NEGative</b> : a trigger event is recognized on the falling edge of a signal.	<b>POSitive</b> <b>NEGative</b>

## Reset Condition

On reset the value is set to **POSitive**.

## Query

**TRIGger[:SEQuence]:SLOPe?**

The query returns the current value of <character\_data>.

## Query Example

**TRIG:SLOP?**

*This command queries the current value of <character\_data> for Channel A.*

## TRIGger[:SEQuence[1]]2:COUnT <numeric\_value>

This command controls the path of the trigger subsystem in the upward traverse of the wait for trigger state. **COUnT** loops through the event detection/measurement cycle are performed. That is, **COUnT** measurements are performed in response to **COUnT** trigger events.

**COUnT** can be set to a value >1 only when:

- [SENSe[1]]|SENSe2:MRATe <character\_data> is set to FAST
- and
- TRIGger[1]|2:SOURce set to BUS, IMMEDIATE or HOLD.

### Syntax

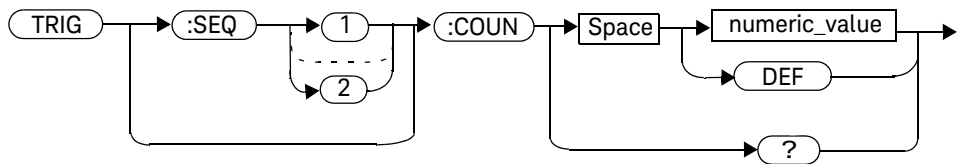

### Parameters

Item	Description/Default	Range of Values
numeric_value	The number of triggered events for the measurement cycle. - DEF: the default value is 1	1 to 50 DEF

## Example

**TRIG:SEQ1:COUN 10**

*This command sets the number of triggered events to 10 for the Channel A measurement cycle.*

## Reset Condition

On reset, the value is set to 1.

## Query

**TRIGger[1]|2[:SEQuence[1]|2]:COUNT?**

The query returns the current setting of trigger events for a specified channel.

## Query Example

**TRIG:SEQ2:COUN?**

*This command queries the number of triggered events for the Channel B measurement cycle.*

## Error Messages

If **COUNT** >1 when **[SENSe[1]]|SENSe2:MRATe <character\_data>** is set to **NORMa1** or **DOUB1e**, error -221, "Settings Conflict" occurs.

## TRIGger[:SEQuence[1]|2]:DELay:AUTO <boolean>

This command is used to determine whether or not there is a settling-time delay before a measurement is made.

When this command is set to:

- **ON**, the power meter inserts a settling-time delay before taking the requested measurement and for subsequent measurements. This settling time allows the internal digital filter to be updated with new values to produce valid, accurate measurement results. The trigger with delay command allows settling time for the internal amplifiers and filters. It does not allow time for power sensor delay.

In cases of large power changes, the delay may not be sufficient for complete settling. Accurate readings can be assured by taking two successive measurements for comparison.

- **OFF**, no settling-time delay is inserted and the power meter makes the measurement immediately a trigger is received.
- **ONCE**, a settling-time delay is inserted before taking the requested measurement, for one measurement only.

TRIGger[:SEQuence[1]|2]:DELay:AUTO is ignored if  
TRIGger[1]|2[:IMMediate] is used to trigger the power meter.

### Syntax

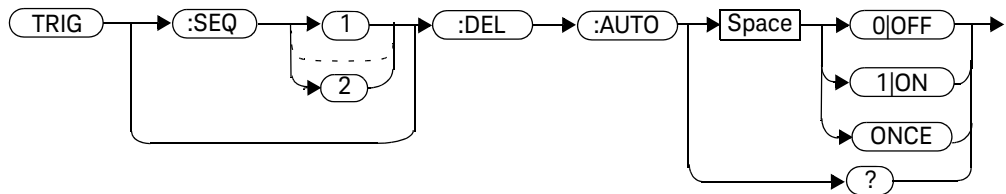

## Example

**TRIG:SEQ:DEL:AUTO ON**

*This command enables a delay on Channel A.*

## Reset Condition

On reset, **TRIGger:DELAy:AUTO** is set to **ON**.

## Query

**TRIGger:DELAy:AUTO?**

The query enters a 1 or 0 into the output buffer indicating the status of **TRIGger:DELAy:AUTO**.

- 1 is returned when it is **ON**
- 0 is returned when it is **OFF**

## Query Example

**TRIG:SEQ2:DEL:AUTO?**

*This command queries the settling-time delay of Channel B.*



## TRIGger[:SEQuence[1]][2]:IMMEDIATE

This command provides a one time over-ride of the normal process of the downward path through the wait for trigger state. It causes the immediate exit of the event detection layer if the trigger system is in this layer when the command is received. In other words, the instrument stops waiting for a trigger and takes a measurement ignoring any delay set by **TRIG:DELay**.

### Syntax

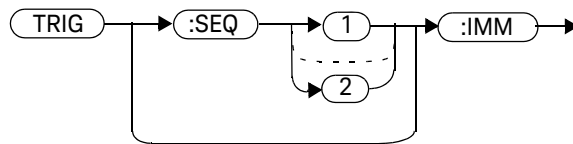

### Example

**TRIG:SEQ:IMM**

*This command initiates a measurement on Channel A.*

## TRIGger[:SEquence[1]|2]:SOURce BUS|EXTernal|HOLD|IMMEDIATE|INTERNAL[[1]|2]

This command configures the trigger system to respond to the specified source. This command only selects the trigger source. Use the **INITiate** command to place the power meter in the wait for trigger state.

### NOTE

This command has the same purpose as TRIGger[1]|2:SOURce  
BUS|EXTernal|HOLD|IMMEDIATE|INTERNAL[[1]|2].

### Syntax

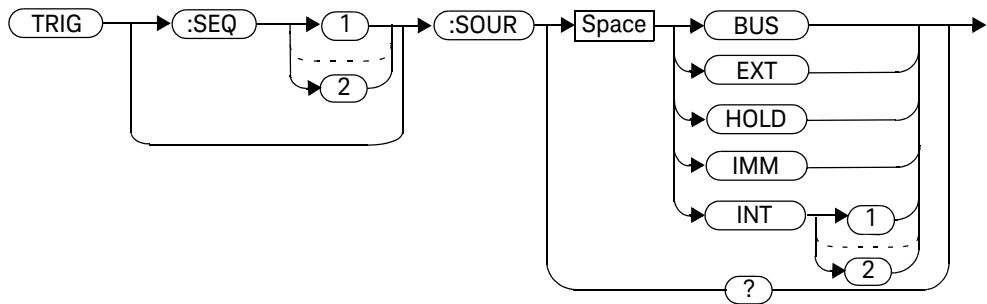

## Parameters

Item	Description/Default	Range of Values
source	<ul style="list-style-type: none"> <li>- Available trigger sources:</li> <li>- <b>BUS</b>: the trigger source is the group execute trigger &lt;GET&gt; bus command, a *TRG common command or the <b>TRIGGER:IMMEDIATE</b> SCPI command.</li> <li>- <b>EXTERNAL</b>: the trigger source is the trigger input in the front panel.</li> <li>- <b>HOLD</b>: triggering is suspended. The only way to trigger the power meter is to use <b>TRIGGER:IMMEDIATE</b>.</li> <li>- <b>IMMEDIATE</b>: the trigger system is always true. If <b>INITiate:CONTinuous</b> is <b>ON</b> the power meter is continually triggering free (free run mode). If an <b>INITiate:IMMEDIATE</b> command is sent a measurement is triggered then the power meter returns to the idle state.</li> <li>- <b>INTERNAL</b>: either <b>INT1</b> (Channel A) or <b>INT2</b> (Channel B).</li> </ul>	<b>BUS</b> <b>EXTERNAL</b> <b>HOLD</b> <b>IMMEDIATE</b> <b>INTERNAL</b> [[1] 2]

### NOTE

The trigger source is set to **IMMEDIATE** on instrument power-up and when entering local mode.

The **MEASURE** and **CONFIGURE** commands automatically set the trigger source to **IMMEDIATE**.

The **READ?** or **MEASURE** commands should not be used if the trigger source is set to **BUS** or **HOLD**.

## Example

```
TRIG:SOUR IMM
```

*This command configures Channel A for immediate triggering.*

## Reset Condition

On reset, the trigger source is set to **IMMEDIATE**.

## Query

**TRIGger[:SEQuence[1]|2]:SOURce?**

The query returns the current trigger source.

## Query Example

**TRIG:SEQ1:SOUR?**

*This command queries the current trigger source for Channel A.*

## Error Messages

- If the leader is changed to **IMM**, **BUS** or **HOLD**, error -221 “Settings Conflict” occurs. In such situations the follower’s **TRIG:SOUR** must be changed so that it is no longer a follower.
- If the source is changed to **INT1**, **INT2** or **EXT** and **SENS:SPEED** has a value of 200, error -221 “Settings Conflict” occurs.
- If the source is changed to **INT1**, **INT2** or **EXT** and **SENS:DET:FUNC** is set to **AVERage**, error -221 “Settings Conflict” occurs.

# 15 UNIT Subsystem

UNIT Subsystem 606  
UNIT[1]2|3|4:POWer <amplitude\_unit> 607  
UNIT[1]2|3|4:POWer:RATio <ratio\_unit> 609

This chapter explains how the **UNIT** command subsystem is used to set the power meter measurement units to Watts and % (linear), or dBm and dB (logarithmic).

## UNIT Subsystem

The **UNIT** command subsystem:

- Sets power measurement units to dBm or Watts.
- Sets measurement ratio units to dB or % (linear).

Both **UNIT** commands have a numeric suffix which determines which window/measurement is set:

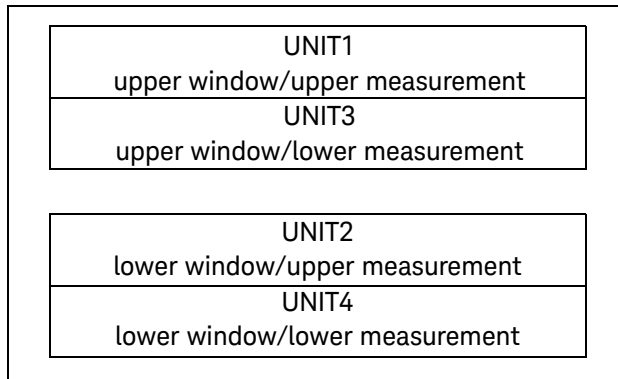

**Figure 15-1** Measurement display UNIT block window

The following commands are described in this section:

Keyword	Parameter Form	Notes	Page
<code>UNIT[1] 2 3 4</code>			
<code>:POWer</code>	<code>&lt;amplitude unit&gt;</code>		page 607
<code>:RATio</code>	<code>&lt;ratio_unit&gt;</code>	[non-SCPI]	page 609

The **UNIT:POWer** and **UNIT:POWer:RATio** commands are coupled as follows:

- If **UNIT:POWer** is set to dBm then **UNIT:POWer:RATio** is dB.
- If **UNIT:POWer** is set to W then **UNIT:POWer:RATio** is %.

## UNIT[1]|2|3|4:POWer <amplitude\_unit>

This command sets the power measurement units for a specified window/measurement. The power suffix set by **UNIT:POWer** is used for any command which accepts a numeric value in more than one unit

- **UNIT1:POWer** sets the power measurement units for the upper window/upper measurement.
- **UNIT2:POWer** sets the power measurement units for the lower window/upper measurement.
- **UNIT3:POWer** sets the power measurement units for the upper window/lower measurement.
- **UNIT4:POWer** sets the power measurement units for the lower window/lower measurement.

For ratio and relative power measurements:

- If **UNIT:POWer** is W, the measurement units are percentage.
- If **UNIT:POWer** is DBM, the measurement units are dB relative.

### Syntax

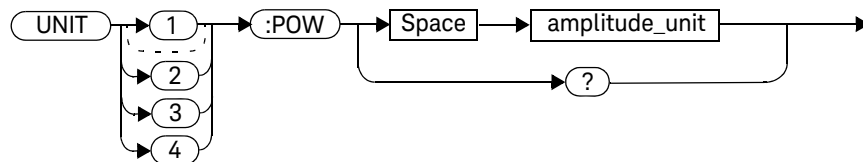

## Parameters

Item	Description/Default	Range of Values
amplitude_unit	The measurement unit. – The default unit is dBm	W DBM

## Example

**UNIT1:POW DBM**

*This command sets the power measurement units for the upper window/upper measurement.*

## Reset Condition

On reset, all windows/measurements are set to DBM.

## Query

**UNIT[1]|2|3|4:POWer?**

The query returns the current setting of the power measurement units.

## Query Example

**UNIT2:POW?**

*This command queries which measurement units are being used on the lower window/upper measurement.*



## UNIT[1]|2|3|4:POWer:RATio <ratio\_unit>

This command sets the window/measurement ratio units.

- **UNIT1:POWer:RATio** sets the ratio measurement units for the upper window/upper measurement.
- **UNIT2:POWer:RATio** sets the ratio measurement units for the lower window/upper measurement.
- **UNIT3:POWer:RATio** sets the ratio measurement units for the upper window/lower measurement.
- **UNIT4:POWer:RATio** sets the ratio measurement units for the lower window/lower measurement.

### Syntax

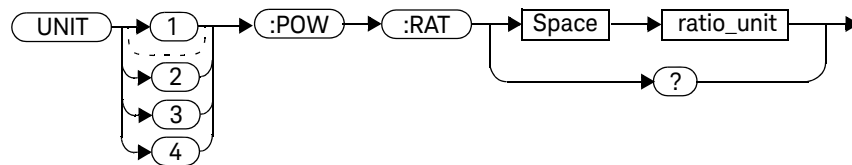

### Parameters

Item	Description/Default	Range of Values
ratio_unit	The ratio measurement unit. - The default unit is DB	DB PCT

## Example

**UNIT1:POW:RAT DB**

*This command sets the ratio measurement units for the upper window/upper measurement.*

## Reset Condition

On reset, the value is set to DB.

## Query

**UNIT[1|2|3|4]:POWER:RATio?**

The query returns the current setting of the ratio measurement units.

## Query Example

**UNIT2:POW:RAT?**

*This command queries which ratio measurement units are being used on the lower window/upper measurement.*

# 16 SERVICE Subsystem

SERVICE Subsystem	613
SERVICE:BIST:CALibrator <boolean>	615
SERVICE:BIST:CW[1]2:LINearity	616
SERVICE:BIST:CW[1]2:LINearity:PERRor?	617
SERVICE:BIST:CW[1]2:ZSET:NUMber?	618
SERVICE:BIST:PEAK[1]2:LINearity <numeric_value>	619
SERVICE:BIST:PEAK[1]2:LINearity:PERRor?	620
SERVICE:BIST:PEAK[1]2:ZSET	621
SERVICE:BIST:PEAK[1]2:ZSET:NUMber?	622
SERVICE:BIST:TBASe:STATe	623
SERVICE:BIST:TBASe:STATe <boolean>	624
SERVICE:BIST:TRIGger:TEST?	626
SERVICE:CALibrator:ADJ:COUR <numeric_value>	627
SERVICE:CALibrator:ADJ:FINE <numeric_value>	628
SERVICE:LAN:PHOStname	629
SERVICE:SECure:ERASe	630
SERVICE:SENSor[1]2:CDATE?	631
SERVICE:SENSor[1]2:CPLace?	632
SERVICE:SENSor[1]2:FREQuency:MAXimum?	633
SERVICE:SENSor[1]2:FREQuency:MINimum?	634
SERVICE:SENSor[1]2:PCALfactor <cal_factor_data>	635
SERVICE:SENSor[1]2:POWer:AVERage:MAXimum?	637
SERVICE:SENSor[1]2:POWer:PEAK:MAXimum?	638
SERVICE:SENSor[1]2:POWer:USABLE:MAXimum?	639
SERVICE:SENSor[1]2:POWer:USABLE:MINimum?	640
SERVICE:SENSor[1]2:RADC?	641
SERVICE:SENSor[1]2:SNUMber?	642
SERVICE:SENSor[1]2:TNUMber?	643

SERvice:SENSor[1]2:TYPE? 644  
SERvice:SNUMber <character\_data> 645  
SERvice:VERSion:PROCCessor <character\_data> 646  
SERvice:VERSion:SYSTem <character\_data> 647

This chapter explains how the **SERvice** command subsystem is used to obtain and set information useful for servicing the power meter.

## SERvice Subsystem

The **SERvice** command subsystem is used to load information such as the power meter processor board revision version and obtain information such as the serial number of the current sensor(s) being used.

Keyword	Parameter Form	Notes	Page
<b>SERvice</b>			
:BIST			
:CALibrator	<boolean>		page 615
:CW[1] 2			
:LINearity		[No query]	page 616
:PERRor?		[query only]	page 617
:ZSET			
:NUMber?		[query only]	page 618
:PEAK[1] 2			
:LINearity	<numeric_value>	[No query]	page 619
:PERRor?		[query only]	page 620
:ZSET		[No query]	page 621
:NUMber?		[query only]	page 622
:TBASe			
:STATe		[No query]	page 623
:STATe	<boolean>		page 624
:TRIGger			
:TEST?		[query only]	page 626
:CALibrator			
:ADJ			
:COUR	<numeric_value>		page 627
:FINE	<numeric_value>		page 628
:LAN			

Keyword	Parameter Form	Notes	Page
:PHOSname			page 629
:SECure			
:ERASe			page 630
:SENSor[1] 2			
:CALFactor	<cal_factor_data>		page 631
:CDATe?		[query only]	page 631
:CPLace?		[query only]	page 632
:FREQuency			
:MAXimum?		[query only]	page 633
:MINimum?		[query only]	page 634
:PCALfactor	<cal_factor_data>		page 635
:POWer			
:AVERAge			
:MAXimum?		[query only]	page 637
:PEAK			
:MAXimum?		[query only]	page 638
:USABle			
:MAXimum?		[query only]	page 639
:MINimum?		[query only]	page 640
:RADc?		[query only]	page 641
:SNUMber?		[query only]	page 642
:TNUMber?		[query only]	page 643
:TYPE?		[query only]	page 644
:SNUMber	<character_data>		page 645
:VERSion			
:PROcEssor	<character_data>		page 646
:SYSTem	<character_data>		page 647

## SERvice:BIST:CALibrator <boolean>

This command enables/disables the calibrator self-test during power-up. It can be used to disable the self-test if it incorrectly indicates a failure. If a load, for example, a sensor, is connected to the calibrator port this could cause the self-test to fail. Also, if it fails the self-test, a Pop-up is displayed for 5 seconds, stating *-If Ref Calibrator test fails disconnect any load attached to it and re-try test.*

### Syntax

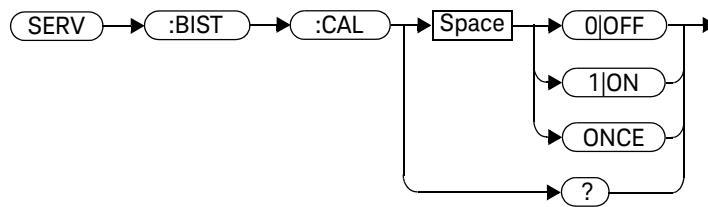

### Example

**SERV:BIST:CAL OFF**

*This command disables the calibrator self-test during power-up.*

### Query

**SERvice:BIST:CALibrator?**

The query enters a 1 or 0 into the output buffer indicating the status of the self-test.

- 1 is returned when the self-test is enabled
- 0 is returned when the self-test is disabled

### Query Example

**SERV:BIST:CAL?**

*This command queries whether the self-test is enabled or disabled.*

## SERVICE:BIST:CW[1]|2:LINEarity

This command initiates the CW linearity test.

### Syntax

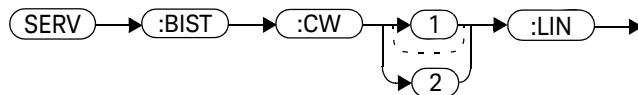

### Example

**SERV:BIST:CW:LIN**

*This command enables the CW linearity test.*



## SERvice:BIST:CW[1]|2:LINEarity:PERRor?

This command returns the worst case error in the CW linearity test.

### Syntax

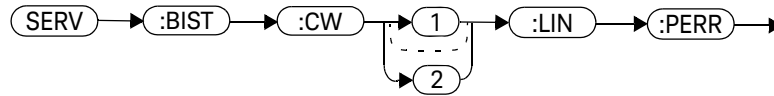

### Example

**SERV:BIST:CW:LIN:PERR?**

*This command queries the worst case error in the CW linearity test.*

## SERVICE:BIST:CW[1]|2:ZSET:NUMBER?

This command returns the worst case error in the CW Zero test invoked by "SERVICE:BIST:PEAK[1 2]:Z SET"

### Syntax

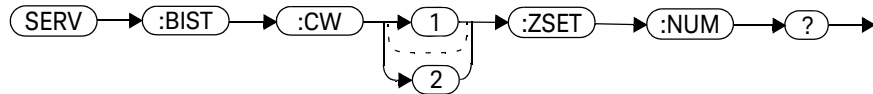

### Example

**SERV:BIST:CW:ZSET:NUM?**

*This command queries the worst case error in the CW zero test.*

## SERvice:BIST:PEAK[1]|2:LINearity <numeric\_value>

This command initiates the PEAK linearity test.

### Syntax

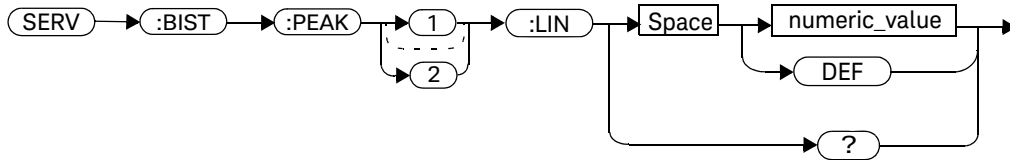

### Parameters

Item	Description/Default	Range of Values
Numeric_value	Define the number of samples taken for results, default:0	0 to 8000

### Example

**SERV:BIST:PEAK:LIN 8000**

*This command sets the number of samples of the PEAK linearity test to be 8000.*

## SERVICE:BIST:PEAK[1]|2:LINEarity:PERRor?

This command returns the PEAK linearity worst case error.

### Syntax

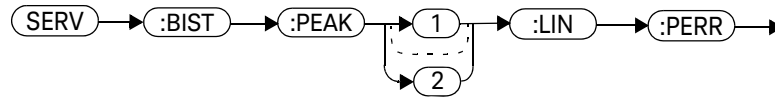

### Example

**SERV:BIST:PEAK:LIN PERR?**

*This command queries the PEAK linearity worst case error.*

## SERVice:BIST:PEAK[1]|2:ZSET

This command initiates the zero set and noise test for both peak and CW for a channel.

### Syntax

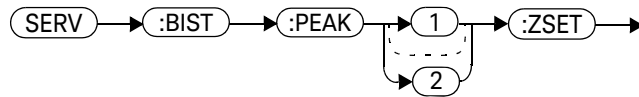

### Example

**SERV:BIST:PEAK1:ZSET**

*This command enables the zero set and noise test for Channel A.*

## SERVICE:BIST:PEAK[1]|2:ZSET:NUMBER?

This command returns the worst case error in the PEAK zero test invoked by "SERVICE:BIST:PEAK[1 2]:ZSET"

### Syntax

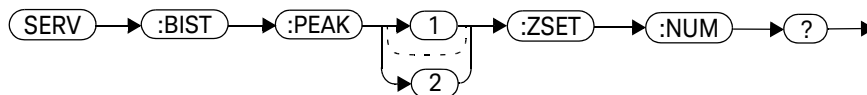

### Example

**SERV:BIST:PEAK:ZSET:NUM?**

*This command queries the worst case error in the PEAK zero test.*

## SERvice:BIST:TBASe:STATe

This command toggles the 10 MHz timebase out of the trigger output.

### Syntax

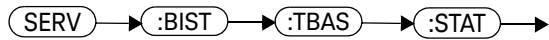

### Example

**SERV:BIST:TBAS:STAT**

*This command toggles the timebase out of the trigger output.*

## SERVICE:BIST:TBAS:STATE <boolean>

This command sends a 10 MHz time base signal to the front panel trig out for testing purposes.

### NOTE

This command overrides the OUTPUT:TRIGGER[:STATE] command.

For example, if OUTPUT:TRIGGER[:STATE] is ON and the command SERVICE:BIST:TBAS ON is sent, this command overrides the Trigger state and sets it to OFF. However, the 10 MHz remains out the Trig out port.

If the SERVICE:BIST:TBAS ON has been sent, the 10 MHz is on and the OUTPUT:TRIGGER[:STATE] is then toggled to ON, the channel trigger is now routed to the Trig out overriding the service command turning the 10 MHz to off.

If the command is set to:

- **ON**, the 10 MHz time base signal is sent to the front panel trigger out connector.
- **OFF**, the 10 MHz time base signal is disabled.

### Syntax

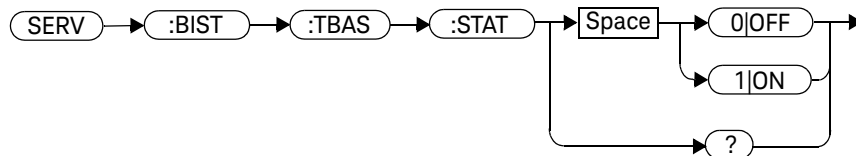

### Example

`SERV:BIST:TBAS:STAT OFF`      *This command disables the signal.*



## Reset Condition

On reset, the signal is disabled.

## Query

### **SERVice:BIST:TBASE:STAT?**

The query enters a 1 or 0 into the output buffer indicating the status of the 10 MHz time base testing.

- 1 is returned when the signal is enabled
- 0 is returned when the signal is disabled

## Query Example

**SERV:BIST:TBASE:STAT?**

*This command queries whether the test is enabled or disabled.*

## SERVICE:BIST:TRIGGER:TEST?

This command queries trigger in and out.

- 1 is returned if the test passes
- 0 is returned if the test fails

**NOTE**

Before running this command, the front panel trigger out must be jumpered to the front panel trigger in.

---

### Syntax



### Example

**SERV:BIST:TRIG:TEST?**

*This command queries trigger in and out.*

## SERvice:CALibrator:ADJ:COUR <numeric\_value>

This command adjust the 1 mW calibrator output in coarse scale.

### Syntax

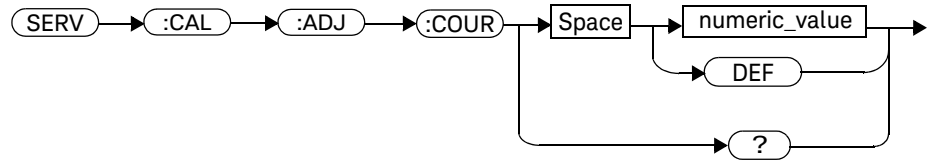

### Parameters

Item	Description/Default	Range of Values
Numeric_value	Adjust the 1 mW Power Reference Level Increment Coarse by 1.	0 to 1023 (Unsigned Int 16)

### Query

**SERV:CAL:ADJ:COUR?**

*The query returns the Reference Calibrator power level in unsigned Int 16.*

## SERVICE:CALibrator:ADJ:FINE <numeric\_value>

This command adjust the 1 mW calibrator output in fine scale.

### Syntax

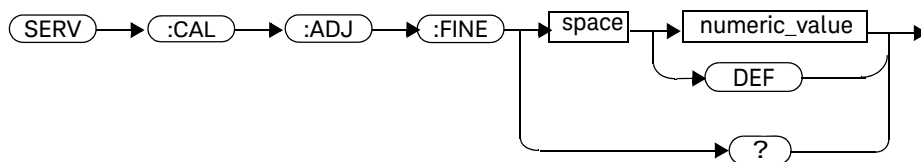

### Parameters

Item	Description/Default	Range of Values
Numeric_value	Adjust the 1 mW Power Reference Level Increment Fine by 1.	0 to 1023 (Unsigned Int 16)

### Query

**SERV:CAL:ADJ:FINE?**

*The query returns the Reference Calibrator power level in unsigned Int 16.*

## SERVice:LAN:PHOSname

This command preset the LAN hostname to its default value. It requires the serial number to be set-up.

### Syntax

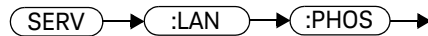

### Example

**SERV:LAN:PHOS**

*The command presets the LAN hostname to its default value.*

## SERVICE:SECure:ERASe

This command erases the P-Series modular power meter's memory, for example, before you return it to Keysight Technologies for repair or calibration, of all data stored in it.

The memory data erased, includes the save/recall states and power on last states.

### Syntax

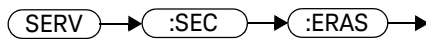

### Example

**SERV:SEC:ERAS**

*The command erases the P-Series modular power meter's memory.*

## SERvice:SENSor[1]|2:CDATe?

This query returns the calibration date in E-Series sensors. Calibration date information is stored in the sensor's EEPROM.

### Syntax

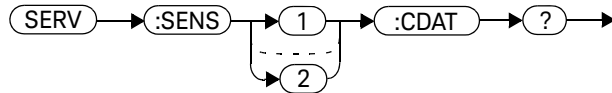

### Example

**SERV:SENS2:CDATe?**

*This query returns the calibration date of the E-Series sensor connected to Channel B.*

### Error Messages

- If no power sensor is connected, error -241 "Hardware missing" occurs.
- If a a sensor other than a P-Series or E-Series power sensor is connected, error -241 "Hardware missing" occurs.

## SERVICE:SENSor[1]2:CPLace?

This query returns the calibration place in E-Series sensors. Calibration place information is stored in the sensor's EEPROM.

### Syntax

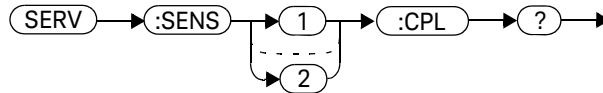

### Example

**SERV:SENS2:CPL?**

*This query returns the place of calibration of the E-Series sensor connected to Channel B.*

### Error Messages

- If no power sensor is connected, error -241 "Hardware missing" occurs.
- If a sensor other than a P-Series or E-Series power sensor is connected, error -241 "Hardware missing" occurs.



## SERvice:SENSor[1]|2:FREQuency:MAXimum?

This query returns the maximum frequency that can be measured by the currently connected sensor. It is applicable to E-Series sensors only. Maximum frequency information is stored in the sensor's EEPROM.

### Syntax

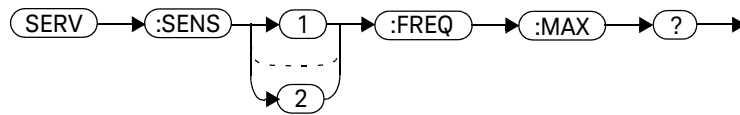

### Example

**SERV:SENS2:FREQ:MAX?**

*This query returns the maximum frequency that can be measured by the E-Series sensor currently connected to Channel B.*

### Error Messages

- If no sensor is connected, error -241, "Hardware missing" occurs.
- If a a sensor other than an E-Series power sensor is connected, error -241 "Hardware missing" occurs.
- If the sensor, currently connected, does not contain the necessary information in EEPROM, error -241 "Hardware missing" occurs.

## SERVICE:SENSor[1]|2:FREQUENCY:MINimum?

This query returns the minimum frequency that can be measured by the currently connected sensor. It is applicable to E-Series sensors only. Minimum frequency information is stored in the sensor's EEPROM.

### Syntax

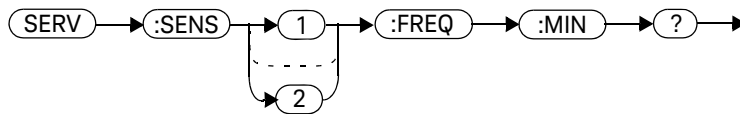

### Example

**SERV:SENS1:FREQ:MIN?**

*This query returns the minimum frequency that can be measured by the E-Series sensor currently connected to Channel A.*

### Error Messages

- If no sensor is connected, error -241, "Hardware missing" occurs.
- If a sensor other than an E-Series power sensor is connected, error -241 "Hardware missing" occurs.
- If the E-Series sensor currently connected does not contain the necessary information in EEPROM, error -241 "Hardware missing" occurs.

## SERvice:SENSor[1]|2:PCALfactor <cal\_factor\_data>

This command writes calibration factor data to, or reads calibration factor data from, the currently connected sensor. The whole calibration factor block must be written at once as a checksum is generated. The new block must not be larger than the existing block.

For E4410 Series and E9300 Series sensors, average path data, refer to “SERvice:SENSor[1]|2:CDATe?” on page 631.

### Syntax

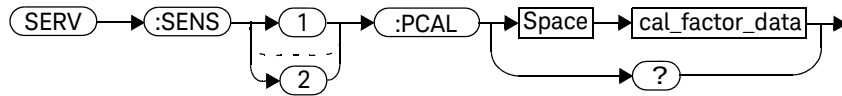

### Parameters

Item	Description/Default
cal_factor_data	A binary data block. Refer to <a href="#">Appendix A</a> , “Calibration Factor Block Layout,” on page A-673 for further information.

### Query

**SERvice:SENSor[1]|2:PCALfactor?**

The query returns the current peak path calibration factor block.

## Query Example

**SERV:SENS:PCAL?**

*This command returns the peak path calibration factor block for Channel A.*

## Error Messages

- If no power sensor is connected, error -241 “Hardware missing” occurs.
- If **INIT:CONT** is not set to **OFF**, error -221, “Settings conflict” occurs.

## SERvice:SENSor[1]|2:POWer:AVERage:MAXimum?

This query returns the maximum average power that can be measured by the currently connected sensor. It is applicable to E-Series sensors only. Maximum average power information is stored in the sensor's EEPROM.

### Syntax

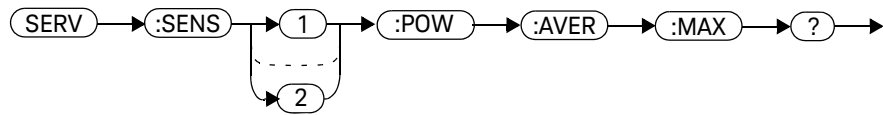

### Example

**SERV:SENS:POW:AVER:MAX?**

*This query returns the maximum average power that can be measured by the E-Series sensor currently connected to Channel A.*

### Error Messages

- If no sensor is connected, error -241, “Hardware missing” occurs.
- If a a sensor other than an E-Series power sensor is connected, error -241 “Hardware missing” occurs.
- If the E-Series sensor currently connected does not contain the necessary information in EEPROM, error -241 “Hardware missing” occurs.

## SERVICE:SENSor[1]]2:POWER:PEAK:MAXimum?

This query returns the maximum peak power that can be measured by the currently connected sensor. It is applicable to E-Series sensors only. Maximum peak power information is stored in the sensor's EEPROM.

### Syntax

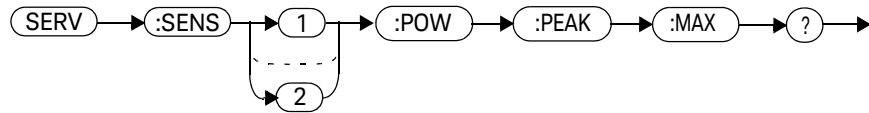

### Example

**SERV:SENS2:POW:PEAK:MAX?**

*This query returns the maximum peak power that can be measured by the E-Series sensor currently connected to Channel B.*

### Error Messages

- If no sensor is connected, error -241, "Hardware missing" occurs.
- If a sensor other than an E-Series power sensor is connected, error -241 "Hardware missing" occurs.
- If the E-Series sensor currently connected does not contain the necessary information in EEPROM, error -241 "Hardware missing" occurs.

## SERvice:SENSor[1]|2:POWer:USABle:MAXimum?

This query returns the maximum power that can be accurately measured by the currently connected sensor. It is applicable to E-Series sensors only. Maximum power information is stored in the sensor's EEPROM.

### Syntax

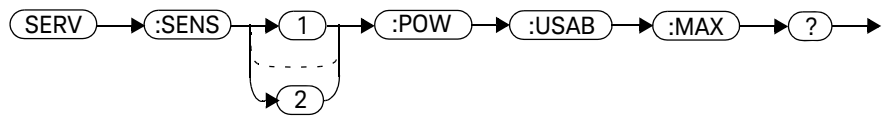

### Example

**SERV:SENS1:POW:USAB:MAX?**

*This query returns the maximum power that can be accurately measured by the E-Series sensor currently connected to Channel A.*

### Error Messages

- If no sensor is connected, error -241, "Hardware missing" occurs.
- If a sensor other than an E-Series power sensor is connected, error -241 "Hardware missing" occurs.
- If the E-Series sensor currently connected does not contain the necessary information in EEPROM, error -241 "Hardware missing" occurs.

## SERVICE:SENSor[1]|2:POWER:USABLE:MINimum?

This query returns the minimum power that can be accurately measured by the currently connected sensor. It is applicable to E-Series sensors only. Maximum power information is stored in the sensor's EEPROM.

### Syntax

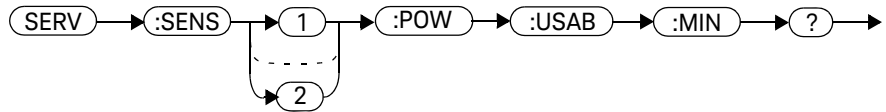

### Example

**SERV:SENS:POW:USAB:MIN?**

*This query returns the minimum power that can be accurately measured by the E-Series sensor currently connected to Channel A.*

### Error Messages

- If no sensor is connected, error -241, "Hardware missing" occurs.
- If a sensor other than an E-Series power sensor is connected, error -241 "Hardware missing" occurs.
- If the E-Series sensor currently connected does not contain the necessary information in EEPROM, error -241 "Hardware missing" occurs.



## SERvice:SENSor[1]|2:RADC?

This query returns a new raw uncorrected measurement in volts, as a 32 bit signed integer.

### Syntax

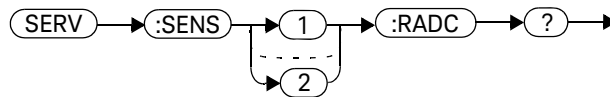

### Example

**SERV:SENS2:RADC?**

*This query returns a new raw uncorrected measurement for the sensor connected to Channel B.*

### Error Messages

- If **INIT:CONT** is set to **ON**, error -221 "Settings Conflict" occurs.

## SERVICE:SENSor[1]]2:SNUMber?

This query returns the serial number for E-Series sensors. Serial number information is stored in the sensor's EEPROM.

### Syntax

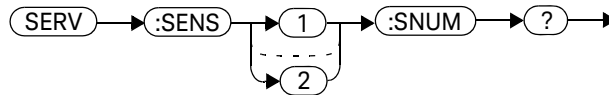

### Example

**SERV:SENS2:SNUM?**

*This query returns the serial number of the E-Series sensor connected to Channel B.*

### Error Messages

- If no sensor is connected, error -241, "Hardware missing" occurs.
- If a a sensor other than a P-Series or E-Series power sensor is connected, error -241 "Hardware missing" occurs.

## SERvice:SENSor[1]|2:TNUMber?

This query returns the tracking number for E-Series sensors. Tracking number information is stored in the sensor's EEPROM.

### Syntax

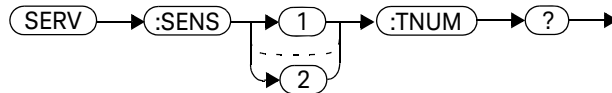

### Example

**SERV:SENS2:TNUM?**

*This query returns the serial number of the E-Series sensor connected to Channel B.*

### Error Messages

- If no sensor is connected, error -241, "Hardware missing" occurs.
- If a sensor other than a P-Series or E-Series power sensor is connected, error -241 "Hardware missing" occurs.

## SERVICE:SENSor[1]2:TYPE?

This query identifies the sensor type connected to the power meter input channel(s). For Keysight 8480 Series sensors, either “A”, “B”, “D”, or “H” is returned. For E-Series sensors, the model number stored in EEPROM is returned.

### Syntax

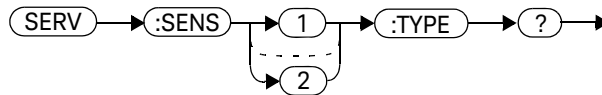

### Example

**SERV:SENS2:TYPE?**

*This query returns either, “A”, “B”, “D”, or “H” if an Keysight 8480 Series sensor is connected to Channel B, or the sensor model number if an E-Series sensor is connected to Channel B.*

### Error Messages

- If no sensor is connected, error -241, “Hardware missing” occurs.

## SERvice:SNUMber <character\_data>

This command loads the power meter with a serial number in the form GB12345678 or US12345678.

### Syntax

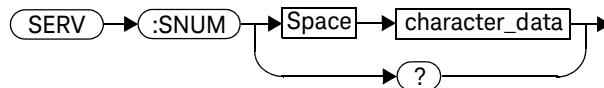

### Parameters

Item	Description/Default	Range of Values
character_data	Details the power meter serial number in the form GB12345678 or US12345678. A maximum of 30 characters can be used.	A to Z (uppercase) a to z (lowercase) 0 - 9

### Example

**SERvice:SNUM GB12345678**

*This command loads the power meter with the serial number GB12345678.*

### Query

**SERvice:SNUMber?**

The query returns the power meter serial number in the form GB12345678 or US12345678.

## SERVICE:VERSION:PROCESSOR <character\_data>

This command loads the power meter with the processor board revision version.

### Syntax

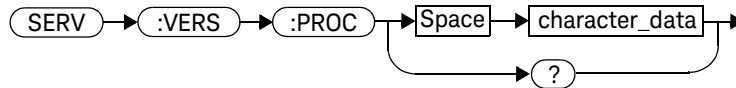

### Parameters

Item	Description/Default	Range of Values
character_data	Details the processor board revision version. A maximum of 20 characters can be used.	A to Z (uppercase) a to z (lowercase) 0 - 9 _ (underscore)

### Example

**SERV:VERS:PROC "C"**

*This command loads the power meter with processor board revision version C.*

### Query

**SERVICE:VERSION:PROCESSOR?**

The query returns the current processor board revision version.

## SERvice:VERSion:SYSTem <character\_data>

This command loads the power meter with the system version number.

### Syntax

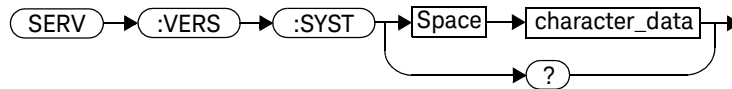

### Parameters

Item	Description/Default	Range of Values
character_data	Details the system version number. A maximum of 20 characters can be used.	A to Z (uppercase) a to z (lowercase) 0 - 9 _ (underscore)

### Example

**SERvice:VERSion:SYST "1"**

*This command loads the power meter with system version number 1.*

### Query

**SERvice:VERSion:SYSTem?**

The query returns the current power meter system version number.







THIS PAGE HAS BEEN INTENTIONALLY LEFT BLANK.

# 17 IEEE 488.2 Command Reference

SCPI Compliance Information	652
*CLS	653
*DDT <arbitrary block program data> <string program data>	654
*ESE <NRf>	656
*ESR?	658
*IDN?	659
*OPC	660
*OPT?	661
*RCL <NRf>	662
*RST	663
*SAV <NRf>	664
*SRE <NRf>	665
*STB?	667
*TRG	669
*TST?	670
*WAI	671

This chapter contains information about the IEEE 488.2 Common Commands that the power meter supports.

## SCPI Compliance Information

This chapter contains information about the SCPI Common (\*) Commands that the power meter supports. It also describes the GPIB Universal Command statements which form the nucleus of GPIB programming; they are understood by all instruments in the network. When combined with programming language codes, they provide all management and data communication instructions for the system.

The IEEE-488.2 Common Command descriptions are listed below in alphabetical order.

<b>*CLS</b>	Clear Status	<a href="#">page 653</a>
<b>*DDT and *DDT?</b>	Define Device Trigger	<a href="#">page 654</a>
<b>*ESE and *ESE?</b>	Event Status Enable	<a href="#">page 656</a>
<b>*ESR?</b>	Event Status Register	<a href="#">page 658</a>
<b>*IDN?</b>	Identify	<a href="#">page 659</a>
<b>*OPC and *OPC?</b>	Operation Complete	<a href="#">page 660</a>
<b>*OPT?</b>	Options	<a href="#">page 661</a>
<b>*RCL</b>	Recall	<a href="#">page 662</a>
<b>*RST</b>	Reset	<a href="#">page 663</a>
<b>*SAV</b>	Save	<a href="#">page 664</a>
<b>*SRE and *SRE?</b>	Service Request Enable	<a href="#">page 665</a>
<b>*STB?</b>	Status Byte	<a href="#">page 667</a>
<b>*TRG</b>	Trigger	<a href="#">page 669</a>
<b>*TST?</b>	Test	<a href="#">page 670</a>
<b>*WAI</b>	Wait	<a href="#">page 671</a>

## \*CLS

The **\*CLS** (Clear Status) command clears the status data structures. The SCPI registers (Questionable Status, Operation Status and all the other SCPI registers), the Standard Event Status Register, the Status Byte, and the Error/Event Queue are all cleared.

### Syntax

**\*CLS** →

**\*DDT** <arbitrary block program data>|<string program data>

The **\*DDT** (Define Device Trigger) command determines the power meter's response to a **GET** (Group Execute Trigger) message or **\*TRG** common command. This command effectively turns **GET** and **\*TRG** into queries, with the measured power being returned.

## Syntax

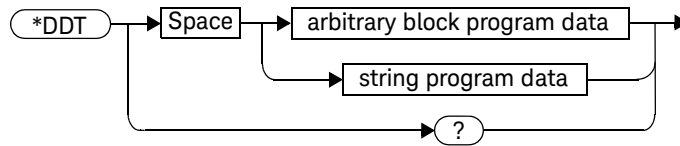

## Parameters

Type	Description	Range of Values
arbitrary block program data	The command which is executed on a <b>GET</b> or <b>*TRG</b> .	#nN<action> <sup>[a],[b]</sup>
string program data		"<action>" <sup>[a]</sup>

[a] The <action> field of the parameter may contain:

FETC?  
 FETC1?  
 FETC2?  
 \*TRG  
 TRIG1  
 TRIG2

[b] The first digit after the # indicates the number of following digits. The following digits indicate the length of the data.

Examples of <arbitrary block program data> parameters are:

- #15FETC? and #206FETCh?

Examples of <string program data> are:

- "FETCh1?", "FETCh?" and "TRIG1;FETC1"

## Reset Condition

On reset, the <action> field of **\*DDT** is set to **\*TRG**.

## Query

### **\*DDT?**

The query returns the action which is performed on receipt of a **GET** or **\*TRG**. This is returned as a <definite length arbitrary block response data> value which is in the form of #nN<action> as described on [page 630](#).

## Error Message

- If an invalid parameter is received, error -224, "Illegal parameter value" occurs.

**\*ESE <NRf>**

The **\*ESE** (Event Status Enable) **<NRf>** command sets the Standard Event Status Enable Register. This register contains a mask value for the bits to be enabled in the Standard Event Status Register. A **1** in the Enable Register enables the corresponding bit in the Status Register, a **0** disables the bit. The parameter value, when rounded to an integer and expressed in base 2, represents the bit values of the Standard Event Status Enable Register. [Table 17-1](#) shows the contents of this register.

**Table 17-1** \*ESE Mapping

Bit	Weight	Meaning
0	1	Operation Complete
1	2	Request Control (not used)
2	4	Query Error
3	8	Device Dependent Error
4	16	Execution Error
5	32	Command Error
6	64	Not used
7	128	Power On

## Syntax

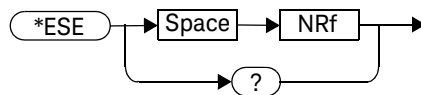



## Parameters

Type	Description/Default	Range of Values
<b>NRf</b>	A value used to set the Standard Event Status Enable Register.	0 - 255

## Query

### **\*ESE?**

The query returns the current contents of the Standard Event Status Enable Register. The format of the return is **<NR1>** in the range of 0 to 255.

## \*ESR?

The **\*ESR?** query returns the contents of the Standard Event Status Register then clears it. The format of the return is **<NR1>** in the range of 0 to 255. [Table 17-2](#) shows the contents of this register.

**Table 17-2** \*ESR? Mapping

Bit	Weight	Meaning
0	1	Operation Complete
1	2	Request Control (not used)
2	4	Query Error
3	8	Device Dependent Error
4	16	Execution Error
5	32	Command Error
6	64	Not used
7	128	Power On

### Syntax



## \*IDN?

The **\*IDN?** query allows the power meter to identify itself. The string returned is either:

**Keysight Technologies,N8262A,<serial number>,A1.XX.YY**

**Keysight Technologies,N8262A,<serial number>,A2.XX.YY**

where:

- **<serial number>** uniquely identifies each power meter.
- **A1.XX.YY** and **A2.XX.YY** represents the firmware revision with XX and YY representing the major and minor revisions respectively.

### Syntax



## \*OPC

The **\*OPC** (OPeration Complete) command causes the power meter to set the operation complete bit in the Standard Event Status Register when all pending device operations have completed.

### Syntax

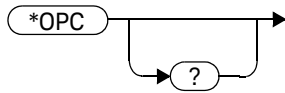

### Query

#### **\*OPC?**

The query places an ASCII 1 in the output queue when all pending device operations have completed.

## \*OPT?

The **\*OPT?** query reports the options installed in the power meter and returns:

- " " empty string for a standard instrument.
- "003" for an option 003 instrument.

### Syntax

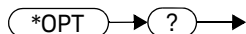

## \*RCL <NRf>

The **\*RCL <NRf>** (ReCaLL) command restores the state of the power meter from the specified save/recall register. An instrument setup must have been stored previously in the specified register.

### Syntax

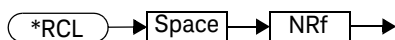

### Parameters

Type	Description/Default	Range of Values
NRf	The number of the register to be recalled.	1 - 10

### Error Message

- If the register does not contain a saved state, error –221, “Settings conflict” occurs.

## \*RST

The **\*RST** (ReSeT) command places the power meter in a known state. Refer to “**SYSTem:PRESet <character\_data>**” on page 473 for information on reset values.

### Syntax

**\*RST** →

**\*SAV <NRf>**

The **\*SAV <NRf>** (SAVe) command stores the current state of the power meter in the specified register.

## Syntax

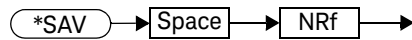

## Parameters

Item	Description/Default	Range of Values
NRf	The number of the register that the current state of the power meter is to be saved to.	1 - 10



**\*SRE <NRf>**

The **\*SRE <NRf>** command sets the Service Request Enable register bits. This register contains a mask value for the bits to be enabled in the Status Byte Register. A **1** in the Enable Register enables the corresponding bit in the Status Byte Register; a **0** disables the bit. The parameter value, when rounded to an integer and expressed in base 2, represents the bits 0 to 5 and bit 7 of the Service Request Enable Register. Bit 6 is always 0. [Table 17-3](#) shows the contents of this register. Refer to the pullout at the end of Chapter 10 for further information.

**Table 17-3** \*SRE Mapping

Bit	Weight	Meaning
0	1	Not used
1	2	Not used
2	4	Device Dependent
3	8	QUEStionable Status Summary
4	16	Message Available
5	32	Event Status Bit
6	64	Not used
7	128	OPERation Status Summary

## Syntax

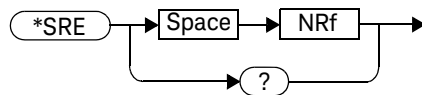

## Parameters

Type	Description/Default	Range of Values
Nrf	A value used to set the Service Request Enable Register.	0 - 255

## Query

### **\*SRE?**

The query returns the contents of bits 0 to 5 and bit 7 of the Service Request Enable Register. The format of the return is **<NR1>** in the ranges of 0 to 63 or 128 to 191 (that is, bit 6 is always 0).

## \*STB?

The **\*STB?** (Status Byte) query returns bit 0 to 5 and bit 7 of the power meter's status byte and returns the Master Summary Status (MSS) as bit 6. The MSS is the inclusive OR of the bitwise combination (excluding bit 6) of the Status Byte and the Service Request Enable registers. The format of the return is **<NR1>** in the ranges of 0 to 255. [Table 17-4](#) shows the contents of this register. Refer to the Status Block Diagram at the end of [Chapter 11](#) for further information.

**Table 17-4** \*STB? Mapping

Bit	Weight	Meaning
0	1	Not used
1	2	Device Dependent 0 - No device status conditions have occurred 1 - A device status condition has occurred
2	4	Error/Event Queue 0 - Queue empty 1 - Queue not empty
3	8	Questionable Status Summary 0 - No QUEStionable status conditions have occurred 1 - A QUEStionable status condition has occurred
4	16	Message Available 0 - no output messages are ready 1 - an output message is ready
5	32	Event Status Bit 0 - no event status conditions have occurred 1 - an event status condition has occurred
6	64	Master Summary Status 0 - power meter not requesting service 1 - there is at least one reason for requesting service
7	128	Operation Status Summary 0 - No OPERation status conditions have occurred 1 - An OPERation status condition has occurred

## Syntax



## \*TRG

The **\*TRG** (TRiGger) command triggers all channels that are in the wait for trigger state. It has the same effect as Group Execute Trigger (**GET**).

Using the **\*DDT** command may change the function of the **\*TRG** command.

### Syntax

**\*TRG** →

### Error Message

- If **TRIGger:SOURce** is not set to **BUS**, error –211, “Trigger ignored” occurs.
- If the power meter is not in the wait-for-trigger state, error –211, “Trigger ignored” occurs.

## \*TST?

The **\*TST?** (TeST) query causes the power meter to perform the self test. The test takes approximately 30 seconds.

The result of the test is placed in the output queue.

- 0 is returned if the test passes
- 1 if the test fails

### Syntax

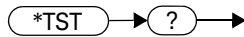

## \*WAI

The **\*WAI** (WAI) command causes the power meter to wait until either:

- All pending operations are complete
- The device clear command is received
- Power is cycled

before executing any subsequent commands or queries.

### Syntax

**\*WAI** →

THIS PAGE HAS BEEN INTENTIONALLY LEFT BLANK.





This information is subject to change without notice. Always refer to the Keysight website for the latest revision.

© Keysight Technologies 2007–2020  
Edition 7, September 18, 2020

Printed in Malaysia



N8262-90008

[www.keysight.com](http://www.keysight.com)