



MDT693B and MDT694B Open-Loop Piezo Controllers

User Guide



















Table of Contents

Chapter 1	Warning Symbol Definitions.....	1
Chapter 2	Safety	2
Chapter 3	Description	3
Chapter 4	Setup	4
	4.1. <i>Setting AC Line Voltage and Fuses</i>	4
	4.2. <i>Changing Fuses</i>	4
	4.3. <i>List of Contents</i>	4
	4.4. <i>Initial Setup</i>	4
Chapter 5	Operation	5
	5.1. <i>MDT693B Front Panel Overview</i>	5
	5.2. <i>MDT693B Back Panel Overview</i>	5
	5.3. <i>MDT694B Front Panel Overview</i>	6
	5.4. <i>MDT694B Rear Panel Overview</i>	6
	5.5. <i>Setting the Output Voltage Limit</i>	7
	5.6. <i>Using INT Adjustment Knob</i>	7
	5.7. <i>Using EXT Input BNC</i>	8
	5.8. <i>Master Scan Control (MDT693B Only)</i>	8
Chapter 6	Bandwidth Performance.....	10
	6.1. <i>Low-Pass Filter</i>	10
	6.2. <i>Output Current Limit</i>	10
Chapter 7	Remote Communications.....	12
	7.1. <i>Installing USB Drivers</i>	12
	7.2. <i>Command-Line Interface</i>	12
	7.3. <i>Keywords (Commands and Queries)</i>	13
Chapter 8	Specifications	15
Chapter 9	Mechanical Drawings.....	17
Chapter 10	Troubleshooting	18
Chapter 11	Warranty	19
Chapter 12	Regulatory	20
Chapter 13	Certifications and Compliance.....	21
Chapter 14	Thorlabs Worldwide Cntacts	23



Chapter 1 Warning Symbol Definitions

Below is a list of warning symbols you may encounter in this manual or on your device.

Symbol	Description
	Direct Current
	Alternating Current
	Both Direct and Alternating Current
	Earth Ground Terminal
	Protective Conductor Terminal
	Frame or Chassis Terminal
	Equipotentiality
	On (Supply)
	Off (Supply)
	In Position of a Bi-Stable Push Control
	Out Position of a Bi-Stable Push Control
	Caution: Risk of Electric Shock
	Caution: Hot Surface
	Caution: Risk of Danger
	Warning: Laser Radiation
	Caution: Spinning Blades May Cause Harm

Chapter 2 Safety

All statements regarding safety of operation and technical data in this instruction manual will only apply when the unit is operated correctly.



 **SHOCK WARNING** 

HIGH VOLTAGE

To avoid electrical shock and before applying power to your MDT693B or MDT694B system, make sure that the protective conductor of the 3-conductor mains power cord is correctly connected to the protective earth contact of the socket outlet!

Improper grounding can cause electric shock resulting in severe injury or even death.

Do not operate without the cover installed. Refer servicing to qualified personnel.

 **WARNING – HIGH VOLTAGE OUTPUTS** 

The MDT693B and MDT694B can produce hazardous voltages and currents. Use **CAUTION** when operating the MDT693B or MDT694B and handling the piezo actuators! The piezo elements are electrical capacitors capable of storing electrical energy over long periods of time. Besides storing charge from the MDT693B or MDT694B, the piezo can accumulate static charge over time due to varying storage temperature and/or mechanical loads. To safely discharge a piezo, connect it to the MDT693B or MDT694B and set the output voltage to 0 volts.

 **WARNING** 

This unit must not be operated in explosive environments.

 **ATTENTION** 

Do not obstruct the air ventilation slots in the housing or fan exhaust.

 **WARNING** 

Before applying power to your MDT693B or MDT694B system, make sure that the protective conductor of the 3-conductor mains power cord is correctly connected to the protective earth contact of the socket outlet! Improper grounding can cause electric shock resulting in severe injury or even death.

With the exception of the mains fuses, there are no user-serviceable parts in this product.

This device can only be returned when packed into the **complete original packaging**, including all foam packing inserts. If necessary, ask for a replacement package.

Mobile telephones, cellular phones, or other radio transmitters are not to be used within the range of three meters of this unit since the electromagnetic field intensity may exceed the maximum allowed disturbance values according to EN50082-1.

Chapter 3 Description

The MDT693B and MDT694B are precision, low-noise, low-drift, high-voltage controllers for piezo actuators. They provide both local and remote control of piezo drive voltages. The MDT694B supports one channel, while the MDT693B supports up to three channels. They are well suited for single-axis and multiple-axis piezo stages, such as Thorlabs' MAX312D Three-Axis NanoMax Stage and PE4 Piezoelectric Actuator. Typical applications include remote alignment of single-mode fiber couplers, high-resolution translation, microscopy, and remote positioning.

The intelligent-speed-control potentiometers on the front panel allow for precise setting of the output voltage over the full operating range. This fine control takes full advantage of the inherently high resolution of the piezo element. The MDT693B three-channel controller provides independent controls for each channel.

The drive voltage can also be controlled externally through a USB interface or by applying an analog voltage (0 to 10 V) to the **EXT** BNC input on the front panel. This voltage is summed with the manual control voltage and multiplied by a gain of 15 V/V.

$$V_{out} = V_{manual} \text{ (or } V_{USB}) + (15V_{external})$$

The external control voltage can be supplied by any stable voltage source, including function generators, DAC outputs, or DC supplies. In addition, the external voltage can be used as part of a feedback loop for automated alignment systems. Since the external input voltage is summed with either the manual or the USB voltage setting, the manual/USB control can be used for offset adjustments without having to re-adjust the external voltage source.

The MDT693B and MDT694B include a voltage limit switch on the rear panel to select the operating voltage range and gain for the unit. Each unit is shipped with the voltage limit set for 0 – 75 V (Gain = 7.5 V/V) operation and may be adjusted by the user to provide 0 – 100 V (Gain = 10 V/V) or 0 – 150 V (Gain = 15 V/V) operation.

The Master Scan feature on the MDT693B allows all three channels to be controlled by one manual adjuster or one external control signal. In this mode, each channel can be precisely adjusted by an offset voltage (**INT** control knob for each axis) and by a gain adjustment (**SCAN TRIM** adjustment for each channel). The gain adjustment allows the output for each channel to be amplified from 80 to 120% of the master control signal.

The MDT693B and MDT694B include 4-digit LED readouts for displaying real-time output voltages of all channels.

These controllers contain a universal power supply. At the time of order, a power cord specific to the region from which your order originates will be included in the box. Should you need a power cord for a different region, please contact your local Thorlabs Tech Support.

Chapter 4 Setup

4.1. Setting AC Line Voltage and Fuses

The MDT693B and MDT694B piezo controllers are shipped configured for 100 to 240 VAC operation. There is no end-user adjustment of the line voltage. Simply select the correct AC line cord for their geographic location.

4.2. Changing Fuses

To change the power fuse, perform the following steps:

1. Remove the AC line cord if it is connected to the unit.
2. Locate the fuse tray directly below the AC line cord connection on the rear panel of the unit.
3. Carefully use a flat blade screwdriver to open the fuse tray.
4. Remove the existing fuse and install the appropriate fuse (600 mA for the MDT693B, 500 mA for the MDT694B). The replacement fuse must be a 5 mm x 20 mm, 250 VAC Type T Fuse (IEC 60127-2/III, low breaking capacity, slow blow).
5. Push the fuse tray back into place, making sure that it snaps and seats correctly.
6. Connect the appropriate line cord into the AC receptacle and plug the unit in.

4.3. List of Contents

1. MDT693B or MDT694B Controller
2. BNC to SMC Adapter (3 Included with MDT693B, 1 Included with MDT694B)
3. USB Type A to Type B Cable
4. Power Cord (Determined by the Region the Order was Placed From)
5. Operating Manual

4.4. Initial Setup

1. Carefully unpack the controller and accessories. If any of the items appear damaged or missing, do not use the controller. Contact your local Thorlabs tech support for assistance.
2. Make sure the **POWER** switch located on the front panel is in the **OFF** position.
3. Plug the female end of the provided AC line cord into the AC input receptacle on the rear of the unit. Plug the male end into a properly grounded AC socket.
4. Select the appropriate output voltage limit on the rear panel. The user can choose from 75 V (Gain = 7.5 V/V), 100 V (Gain = 10 V/V), or 150 V (Gain = 15 V/V) limits.

This switch should only be adjusted while the piezo(s) are disconnected or when the unit is off.

5. Connect the piezo device to the controller output(s). *Do not connect piezo devices to the unit while the unit is on.*
6. Turn the **POWER** switch to the **ON** position.
7. Push and turn the **INT** control knob to adjust the piezo output voltage. For more advanced controls such as the external input, master scan controls, or USB operation, please see the Table of Contents for the appropriate section of this manual. **Note: The Push to adjust requirement can be disabled with the command "pushdisable=1", when disabled the output will be adjusted with any rotation of the knob and the right-most decimal will no longer blink.**

Chapter 5 Operation

5.1. MDT693B Front Panel Overview

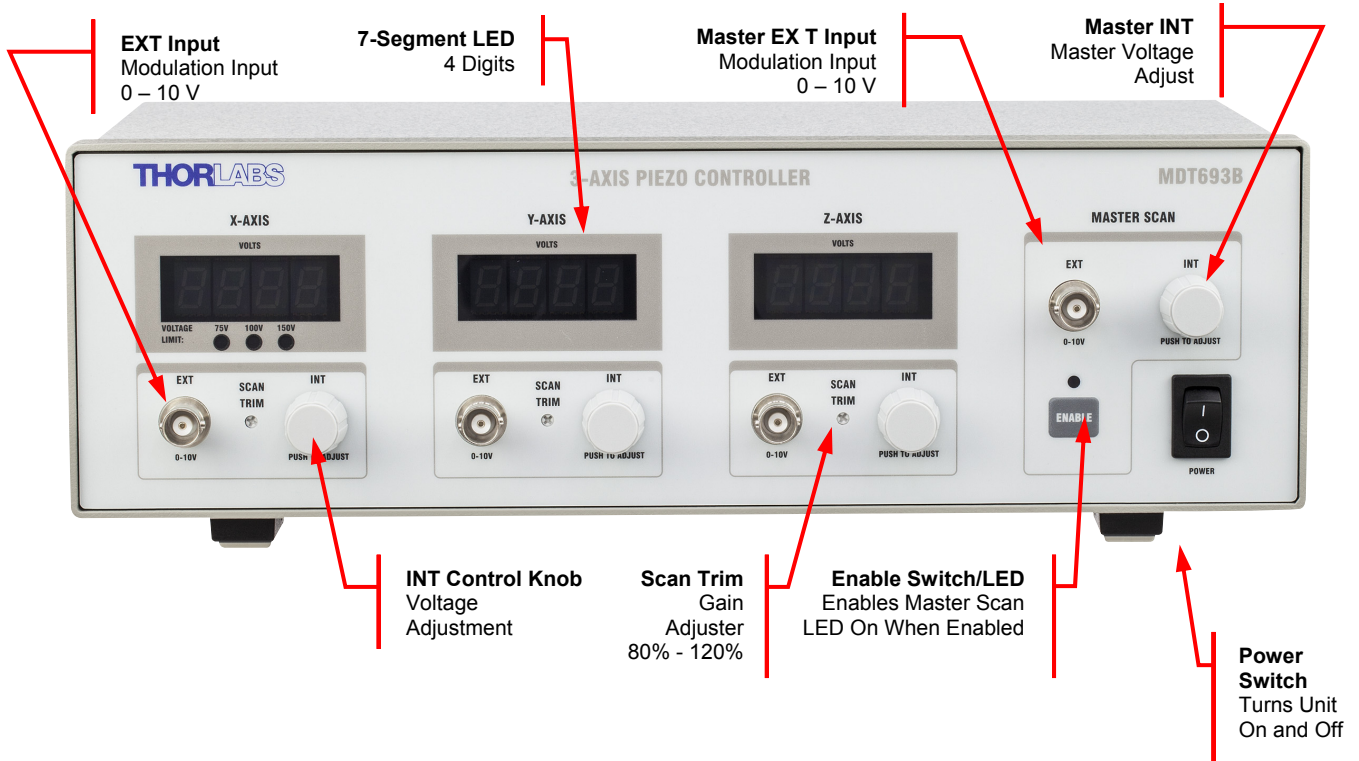

5.2. MDT693B Back Panel Overview

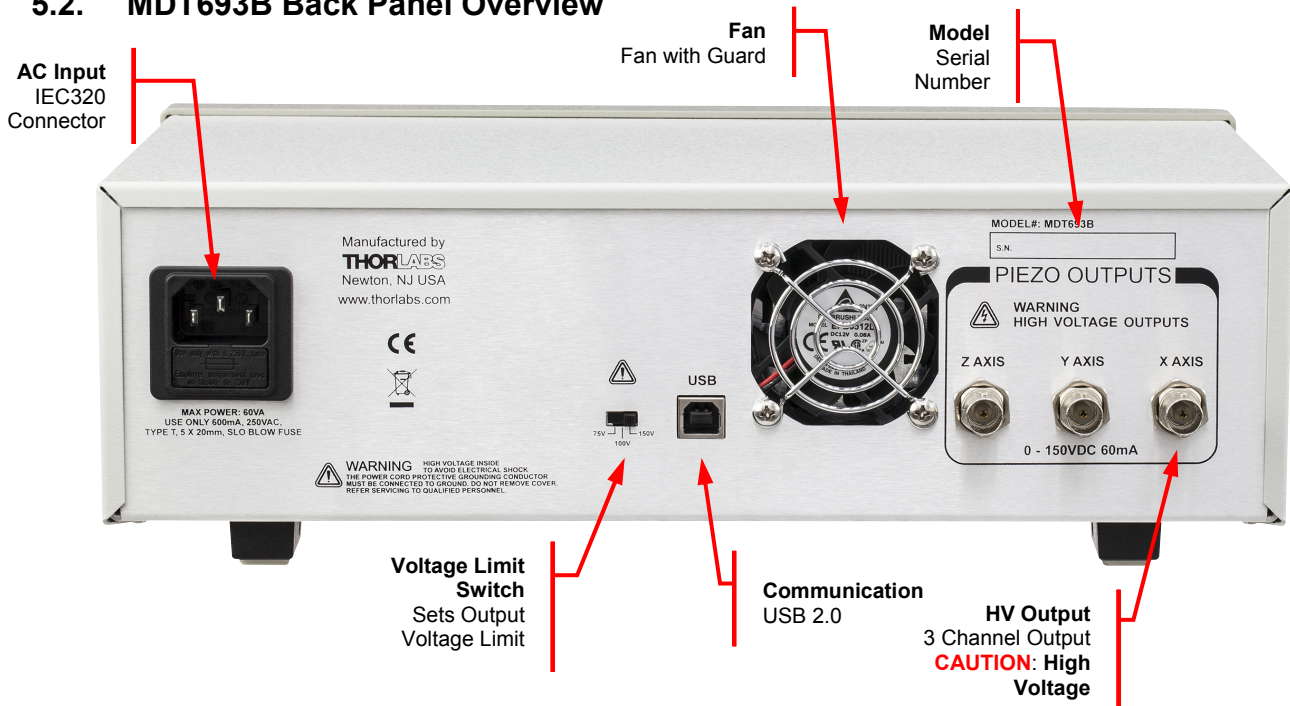

5.3. MDT694B Front Panel Overview

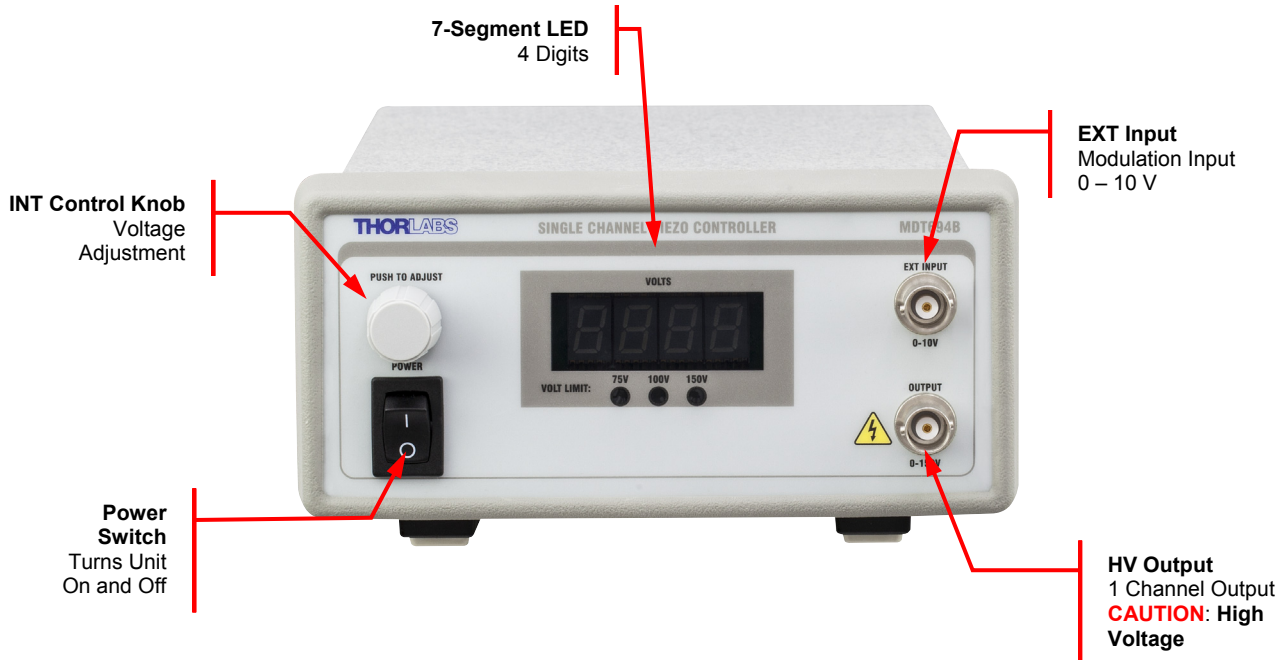

5.4. MDT694B Rear Panel Overview

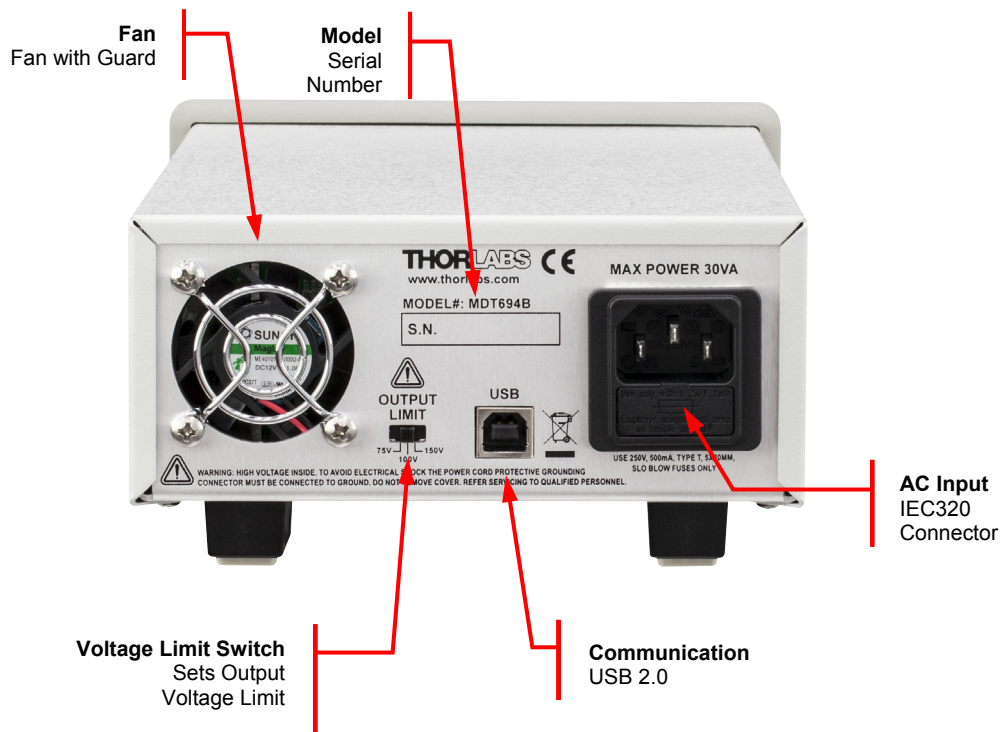

5.5. Setting the Output Voltage Limit

The MDT693B and MDT694B include a voltage limit switch on the rear panel that can be used to limit the maximum output voltage to 75 V, 100 V, or 150 V. The lower limit is intended for lower-drive-voltage piezos. Thorlabs ships the controllers to operate at the 75 V limit by default. However, it can be easily adjusted, as described below:

1. Determine the maximum allowable voltage for your piezo element (V_{PIEZO}). We recommend the following settings:
 - a. Use the 150 V limit when $V_{\text{PIEZO}} \geq 150$ V.
 - b. Use the 100 V limit when $150 \text{ V} \geq V_{\text{PIEZO}} \geq 100$ V.
 - c. Use the 75 V limit when $100 \text{ V} \geq V_{\text{PIEZO}} \geq 75$ V.
2. Power off the MDT693B or MDT694B and disconnect the piezo(s).
3. Locate the Voltage Limit switch on the rear panel of the MDT693B or MDT694B.
4. Adjust the switch to the desired limit setting determined in Step 1.
5. Turn the controller on. The onboard micro controller will automatically configure the controller to the appropriate settings. The gain of the **EXT** input BNC connector(s) will vary depending on the gain setting. For the 150 V limit, the gain is 15 V/V; for the 100 V setting, the gain is 10 V/V; and for the 75 V setting, the gain is 7.5 V/V.

5.6. Using INT Adjustment Knob

The **INT** adjustment knobs manually control the output voltages for each channel from 0 V to 150 V. This can be thought of as a DC offset voltage, since it is summed with the external control voltage (up to a maximum control voltage of 10 V). Note that changing the voltage through USB commands overrides the INT knob.

By default all adjustment knobs include a lockout feature to prevent accidental adjustment. To adjust the voltage setting, the knob must first be pushed in to unlock it. On the corresponding display, the right-most decimal point will blink after the knob is pushed in, indicating that it is ready for adjustment. To lock the setting, press the knob in again. The knob will automatically relock after 30 seconds of no activity. **Note: *The Push to adjust requirement can be disabled with the command “pushdisable=1”, when disabled the output will be adjusted with any rotation of the knob and the right-most decimal will no longer blink.***

The manual adjustment knobs are auto scaling: Adjusting the knob slowly will adjust the output at the highest resolution, and adjusting the knob quickly will make larger voltage adjustments.

Follow the procedure described on the next page for operation in this mode.

1. Attach a piezo to one of the high voltage output connectors on the rear panel of the MDT693B or the front panel of the MDT694B.
Note: *The BNC center conductor is positive and the shield is at ground potential. Be certain to match piezo polarity to the connector since most piezo elements will be permanently damaged if connected backwards.*
2. Turn the power switch (located on the front panel) to the **ON** position. The digital displays should begin displaying the output voltage settings. The factory default output setting is 0 V. The unit recalls the previous output state when it is powered on.
3. Set all the output voltages to 0 V by pushing in the control knob and rotating the knob counter-clockwise. The right-most decimal point will blink after the knob is pushed in, indicating that the setting can be adjusted. After 30 seconds of no activity, the display will stop blinking. **Note: *The Push to adjust requirement can be disabled with the command “pushdisable=1”, when disabled the output will be adjusted with any rotation of the knob and the right-most decimal will no longer blink.***
4. Adjust the **INT** knob for each channel until the desired voltages are met.

5.7. Using EXT Input BNC

The **EXT** input on the MDT693B and MDT694B is designed to allow the user to modulate the output voltage or for use as feedback with positioning systems. Examples of connections for this input include D/A systems, strain gauges with support electronics, and function generators. The external control voltage is summed with either the **INT** control knob or the USB voltage setting (changing the voltage through USB will override the **INT** knob), up to a maximum control voltage of 10 V. To use this feature, follow the steps below.

1. Attach a piezo to one of the high voltage output connectors on the rear panel of the MDT693B or the front panel of the MDT694B.

Note: *The BNC center conductor is positive and the shield is at ground potential. Be certain to match piezo polarity to the connector since most piezo elements will be permanently damaged if connected backwards.*

2. Turn the power switch to the **ON** position.
3. Set all the output voltages to 0 V by pushing in the control knob and rotating the knob counter-clockwise. The right-most decimal point will blink after the knob is pushed in, indicating that the setting can be adjusted. After 30 seconds of no activity, the display will stop blinking. **Note:** *The Push to adjust requirement can be disabled with the command “pushdisable=1”, when disabled the output will be adjusted with any rotation of the knob and the right-most decimal will no longer blink.*
4. Connect an analog input signal (AC or DC), with a voltage between 0 V and 10 V, to the **EXT** input BNC connector(s). The output for each channel will follow the **EXT** input voltage with a gain of 7.5 V/V, 10 V/V, or 15 V/V, depending upon the output voltage limit (see Section 5.5, page 7).

Note: *Do not place a negative voltage on the EXT input BNC connector. The MDT693B and MDT694B include reverse protection diodes on the EXT inputs, designed to prevent the piezo output from going negative. Presenting negative voltages for long periods of time will damage these diodes and affect the operation of the unit.*

5. For sinusoidal and ramp signals, calculate the output current and verify that it will not exceed the maximum current rating of **60 mA**. A piezo acts like a capacitor; therefore the output current is a function of the change in voltage divided by the change in time. The MDT693B and MDT694B both have an output-current-limiting circuit to prevent damage to the unit, but the output sinusoid will be distorted.

5.8. Master Scan Control (MDT693B Only)

The Master Scan feature allows all three channels to be controlled by one manual adjuster or one external control signal. Each channel has an independent gain adjustment (SCAN TRIM) that allows the user to compensate for differences between each piezo. The output of each channel is summed with the **INT** control knobs to provide a different DC offset for each channel.

The Master Scan mode is especially useful for three-axis mounts such as the MAX312D. The SCAN TRIM gain controls and the **INT** knobs allow the user to precisely tune each output separately, while the **MASTER SCAN INT** and **MASTER SCAN EXT** controls adjust all channels simultaneously.

Enable Button

The **ENABLE** button located on the front panel (see Section 5.1, page 5) is used to enable and disable Master Scan mode. The **EXT** in for each channel will be disabled and replaced by the master scan **EXT** signal.

Enable LED

The enable LED, located directly above the **ENABLE** button, will light when Master Scan mode is activated.

Master Scan EXT

An analog voltage between 0 V and 10 V can be applied to this input to control all three channels over a voltage range of 0 V to 75 V, 0 V to 100 V, or 0 V to 150 V. This input will be summed with the **MASTER SCAN INT** and the individual **INT** knobs for each channel, up to a maximum control voltage of 10 V. The **MASTER SCAN EXT**

input is only active when Master Scan mode is active (i.e., the enable LED must be lit). Note that the individual EXT in for each channel is disabled when Master Scan mode is active.

Master Scan INT

The **MASTER SCAN INT** knob allows adjustment of all three channels over the full operating range of 0 V to 75 V, 0 V to 100 V, or 0 V to 150 V. This input will be summed with the **MASTER SCAN EXT** and the individual **INT** knobs for each channel, up to a maximum control voltage of 10 V. The **MASTER SCAN INT** knob will only be active when Master Scan mode is active (i.e., the enable LED must be lit).

Master Scan Trim

The **SCAN TRIM** adjusters scale the signals provided by the **MASTER SCAN INT** and **MASTER SCAN EXT** knobs over a range from 80% to 120% on a per-channel basis. This helps compensate for differences in reactance from one piezo to another. The **SCAN TRIM** adjusters are only active when Master Scan mode is active (i.e., the enable LED must be lit).

Note: The 100% mark is halfway through the adjustment range of the SCAN TRIM potentiometer. To approximately set the SCAN TRIM to 100%, zero the pot by turning it counterclockwise as far as possible (a maximum of four turns). Then adjust the pot clockwise by two turns.

To precisely set the **SCAN TRIM** to 100%, follow this procedure:

- Adjust all of the **INT** control knobs counterclockwise as far as possible.
- Disconnect any **EXT** input connections.
- Adjust all **SCAN TRIM** pots counterclockwise by a minimum of four turns.
- Apply a 5 V DC voltage source to the **MASTER SCAN EXT** input.
- Adjust the **SCAN TRIM** pots clockwise until their displays read 75 V (assuming the voltage limit is set to 150 V).

Chapter 6 Bandwidth Performance

The MDT693B and MDT694B are precision, low-noise, low-drift, high-voltage amplifiers designed specifically for driving piezo actuators. There are two limitations that need to be considered. Since piezoelectric crystals can be modeled as capacitors, it is easy to predict their dynamic performance using a basic set of equations as described below.

6.1. Low-Pass Filter

Since the piezo can be modeled most accurately as a capacitor, the piezo will create a low-pass filter with the output impedance of the driver. For both the MDT693B and MDT694B, the output impedance is specified as 150 Ω , 1 nF.

$$BW = \frac{1}{(2\pi R_{OUT}C)}$$

Where,

$$C = C_{OUT} + C_{PIEZO}$$

For example, consider connecting a piezo with a 1.6 μ F capacitance to the MDT693B. Using the output impedances given in the specification section (see page 15):

$$BW = \frac{1}{2\pi(150\Omega)(1\text{nF} + 1.6\mu\text{F})}$$

$$BW = 663 \text{ Hz}$$

6.2. Output Current Limit

The output current limit also needs to be considered when determining system performance. Since the piezo is electrically equivalent to a capacitor (C_{PIEZO}), the charge rate ($\Delta V/\Delta t$) needs to be considered. The max current for the MDT693B and MDT694B is 60 mA (I_{OUT}).

$$I_{OUT} = C_{PIEZO} \frac{\Delta V}{\Delta t}$$

The output current requirements depend upon how quickly the piezo needs to be charged, not the voltage applied to it. Below are some common waveforms and their calculations.

Linear Ramp Signal

$$I_{OUT} = C \left(\frac{\Delta V}{\Delta t} \right)$$

$$\Delta t = \left(\frac{C(\Delta V)}{I_{OUT}} \right)$$

Triangle Wave

$$I_{OUT} = 2C \left(\frac{\Delta V}{\Delta T} \right)$$

$$\Delta t = \left(\frac{C(\Delta V)}{I_{OUT}} \right)$$

$$f = \frac{1}{\Delta t}$$

Sinusoid Wave

$$I_{OUT} = C\omega V_{AMP} \cos(\omega t)$$

$$I_{OUT(PK)} = 2\pi f V_{AMP} C$$

$$f = \frac{I_{OUT}}{2\pi V_{AMP} C}$$

Where

$$V = V_{AMP} \sin(\omega t) \text{ and } \omega = 2\pi f$$

For all equations above,

$$C = C_{OUT} + C_{PIEZO}$$

Chapter 7 Remote Communications

7.1. Installing USB Drivers

Prior to running the command-line interface, the USB drivers must be installed. To install the drivers **the user must have administrative rights** on the computer, also depending on the operating system used you may need to right click on the “CD-Starter2.exe” application located on the CD and choose the “Run as Administrator” menu option. **The MDT693B and MDT694B must not be connected to the PC while installing the drivers.** Insert the CD that was supplied with your unit into your PC. From the dialog box that is displayed, select the Install Drivers button. If the dialog box is not displayed, browse to the CD in Windows and run CD_Started.exe. Follow the onscreen prompts to install the driver. After the driver is installed, attach the MDT693B or MDT694B to the PC and power it on. Your PC will then detect the new hardware and will prompt you when the installation is complete.

7.2. Command-Line Interface

Once the USB drivers have been installed, the unit connected to the PC, and the power turned on, configure the terminal emulator as follows:

- Baud Rate = **115.2 kb/s**
- Data Bits = **8**
- Parity = **None**
- Stop Bits = **1**
- Flow Control = **None**

If the connection is correct you will see the following after pressing the “Enter” key.

```
CMD_NOT_DEFINED>
```

The basic structure of the interface is a keyword followed by either an equals sign “=” or a question mark “?”. The “=” or “?” will determine if the string is a command or a query. All strings (commands and queries) must be terminated by a carriage return (CR) or a line feed (LF) or any combination of a carriage return and a line feed or pressing the ENTER key on the computer.

The command structure is as follows:

```
Keyword = argument (Command Terminator)
```

Where “keyword” defines the function and “argument” is a numerical value followed by any valid command terminator. A valid command terminator is a carriage return (CR), a line feed (LF) or any combination of a carriage return and line feed. See listing below.

The query structure is a follows:

```
Keyword? (Command Terminator)
```

The “keyword” defines the function and the question mark (?) indicates a query. The query is terminated by any valid command terminator. A valid command terminator is a carriage return (CR), a line feed (LF) or any combination of a carriage return and line feed. See listing below.

There are a few exceptions to this which are noted below, also noted are unique shortcut keys.

The prompt symbol “>” will appear on power up and after a command is accepted by the system indicating it is ready to receive another command line.

7.3. Keywords (Commands and Queries)

The following list shows all available commands and queries, and summarizes their functions for the MDT693B:

Command ¹	Syntax ²	Description
Get Commands	?	List the available commands.
Product Information	id?	Returns the product header and firmware version
Restore Default Settings	restore	Restores default factory settings
Get Echo Command Value	echo?	Returns echo status
Set Echo Command	echo= <i>n</i>	Sets Echo mode. When the echo mode is on the command parameters will be returned, or echoed back, to the communication program. (Values: 1 = enable; 0 = disable)
Limit Switch Setting	vlimit?	Returns output voltage limit setting. (75V = 0; 100V = 1; 150V = 2)
Get Display Intensity	intensity?	Returns the display intensity
Set Display Intensity	intensity= <i>n</i>	Set the Display Intensity (0-15).
Set All Voltages	allvoltage= <i>n</i>	Sets all outputs to desired voltage.
Get Master Scan Enable	mselect?	Returns the state of the Master Scan enable.
Set Master Scan Enable	mselect= <i>n</i>	Sets Master Scan mode. (Values: 1 = enable; 0 = disable)
Get Master Scan Voltage	msvoltage?	Reads and Returns the master scan voltage
Set Master Scan Voltage	msvoltage= <i>n</i>	Sets a master scan voltage that adds to the x, y, and z axis voltages. (Sets master scan DAC)
Read X-Axis Voltage	xvoltage?	Reads and returns the X axis output voltage.
Set X-Axis Voltage	xvoltage= <i>n</i>	Set the output voltage for the X axis.
Read Y-Axis Voltage	yvoltage?	Reads and returns the Y axis output voltage.
Set Y-Axis Voltage	yvoltage= <i>n</i>	Set the output voltage for the Y axis.
Read Z-Axis Voltage	zvoltage?	Reads and returns the Z axis output voltage.
Set Z-Axis Voltage	zvoltage= <i>n</i>	Set the output voltage for the Z axis.
Read Min. X-Axis Voltage	ymin?	Reads the minimum output voltage limit for X axis.
Set Min. X-Axis Voltage	xmin= <i>n</i>	Sets the minimum output voltage limit for X axis.
Read Min. Y-Axis Voltage	ymin?	Reads the minimum output voltage limit for Y axis.
Set Min. Y-Axis Voltage	ymin= <i>n</i>	Sets the minimum output voltage limit for Y axis.
Read Min. Z-Axis Voltage	zmin?	Reads the minimum output voltage limit for Z axis.
Set Min. Z-Axis Voltage	zmin= <i>n</i>	Sets the minimum output voltage limit for Z axis.
Read Max. X-Axis Voltage	xmax?	Reads and returns the maximum output voltage limit for X axis.
Set Max. X-Axis Voltage	xmax= <i>n</i>	Sets the maximum output voltage limit for X axis.
Read Max. Y-Axis Voltage	ymax?	Reads and returns the maximum output voltage limit for Y axis.
Set Max. Y-Axis Voltage	ymax= <i>n</i>	Sets the maximum output voltage limit for Y axis.
Read Max. Z-Axis Voltage	zmax?	Reads and returns the maximum output voltage limit for Z axis.
Set Max. Z-Axis Voltage	zmax= <i>n</i>	Sets the maximum output voltage limit for Z axis.
Get voltage adjustment resolution	dacstep?	Reads the current step resolution
Set voltage adjustment resolution	dacstep= <i>n</i>	Sets the step resolution when using up/down arrow keys (n = 1 to 1000)
Increment Voltage	Up arrow	Increments the current channel voltage by resolution set in dacsteps (Adjustment range: 0 to 65536, limited by factory calibrated limit)
Decrement Voltage	Down arrow	Decrements the current channel voltage by resolution set in dacsteps (Adjustment range: 0 to 65536, limited by factory calibrated limit)
Decrease channel	Left arrow	Decreases channel setting and returns value (order: master scan if enabled, z axis, y axis, x axis)
Increase channel	Right arrow	Increases channel setting and returns value (order: master scan if enabled, z axis, y axis, x axis)
Get Friendly Name	friendly?	Returns the friendly name.
Set Friendly Name	friendly= <i>string</i>	Sets the friendly name.
Get Serial Number	serial?	Returns the serial number.
Get Compatibility Mode	cm?	Returns compatibility mode (0 = disabled, 1 = enabled)
Set Compatibility Mode	cm= <i>n</i>	Sets compatibility mode (0 = disable, 1 = enable)
Get Rotary Mode	rotarymode?	Returns the rotary controls mode. (0 = Default, 1 = 10 turn pot, 2 = fine)
Set Rotary Mode	rotarymode= <i>n</i>	Sets the rotary controls mode. (0 = Default, 1 = 10 turn pot, 2 = fine)
Get disable rotary push to adjust	disablepush?	Gets the disable rotary push to adjust requirement setting. (0 = push required, 1 = push not required)
Set disable rotary push to adjust	disablepush= <i>n</i>	Returns the disable rotary push to adjust requirement setting. (0 = push required, 1 = push not required)

The following list shows all available commands and queries, and summarizes their functions for the MDT694B:

¹ All commands and queries are not case sensitive.

² The MDT693B will recognize MDT693A commands.

Command ³	Syntax ⁴	Description
Get Commands	?	List the available commands.
Product Information	id?	Returns the product header and firmware version
Restore Default Settings	restore	Restores default factory settings
Get Echo Command Value	echo?	Returns echo status
Set Echo Command	echo= <i>n</i>	Sets Echo mode. When the echo mode is on the command parameters will be returned, or echoed back, to the communication program. (Values: 1 = enable; 0 = disable)
Limit Switch Setting	vlimit?	Returns output voltage limit setting. (75V = 0; 100V = 1; 150V = 2)
Get Display Intensity	intensity?	Returns the display intensity
Set Display Intensity	intensity= <i>n</i>	Set the Display Intensity (0-15).
Read X-Axis Voltage	xvoltage?	Returns the X axis output voltage.
Set X-Axis Voltage	xvoltage= <i>n</i>	Set the output voltage for the X axis.
Read Min. X-Axis Voltage	Xmin?	Returns the minimum output voltage limit for X axis.
Set Min. X-Axis Voltage	xmin= <i>n</i>	Sets the minimum output voltage limit for X axis.
Read System Min. Voltage	sysmin?	Returns the minimum output voltage for the system.
Set System Min. Voltage	sysmin= <i>n</i>	Sets the minimum output voltage for the system.
Read Max. X-Axis Voltage	Xmax?	Returns the maximum output voltage limit for X axis.
Set Max. X-Axis Voltage	xmax= <i>n</i>	Sets the maximum output voltage limit for X axis.
Read System Max. Voltage	sysmax?	Returns the maximum output voltage for the system.
Set System Max. Voltage	sysmax= <i>n</i>	Sets the maximum output voltage for the system.
Get voltage adjustment resolution	dacstep?	Reads the current step resolution
Set voltage adjustment resolution	dacstep= <i>n</i>	Sets the step resolution when using up/down arrow keys (n = 1 to 1000)
Increment Voltage	Up arrow	Increments the current channel voltage by resolution set in dacsteps (Adjustment range: 0 to 65536, limited by factory calibrated limit)
Decrement Voltage	Down arrow	Decrements the current channel voltage by resolution set in dacsteps (Adjustment range: 0 to 65536, limited by factory calibrated limit)
Get Friendly Name	friendly?	Returns the friendly name.
Set Friendly Name	friendly= <i>string</i>	Sets the friendly name.
Get Serial Number	serial?	Returns the serial number.
Get Compatibility Mode	cm?	Returns compatibility mode (0 = disabled, 1 = enabled)
Set Compatibility Mode	cm= <i>n</i>	Sets compatibility mode (0 = disable, 1 = enable)
Get Rotary Mode	rotarymode?	Returns the rotary controls mode. (0 = default, 1 = 10 turn pot, 2 = fine)
Set Rotary Mode	rotarymode= <i>n</i>	Sets the rotary controls mode. (0 = default, 1 = 10 turn pot, 2 = fine)
Get disable rotary push to adjust	disablepush?	Returns the disable rotary push to adjust requirement setting. (0 = push required, 1 = push not required)
Set disable rotary push to adjust	disablepush= <i>n</i>	Sets the disable rotary push to adjust requirement setting. (0 = push required, 1 = push not required)

If the keyword, format, or argument is incorrect or out of range, the unit will return an exclamation point. The function is determined by the value set with the mode command in the above table.

In addition to the above commands, there is also special functionality added to the arrow keys of the computer's keyboard.

³ All commands and queries are not case sensitive.

⁴ The MDT694B will recognize MDT694A commands.

Chapter 8 Specifications

All specifications are for both MDT693B and MDT694B unless noted explicitly.

General Features	
AC Input Voltage	100 - 240 VAC
AC Input Frequency	50 – 60 Hz
AC Input Power (Max)	
MDT693B	60 VA
MDT694B	30 VA
Operating Temperature	10 to 40 °C
Fuse Type	IEC60127-2/3 (250 VA, Slow Blow Type 'T')
Fuse Size	5 mm x 20 mm
Fuse Rating	
MDT693B	600 mA
MDT694B	500 mA

Performance	
Input/Output Specs	
External Input Voltage	0 – 10 V
External Input Impedance	10 k Ω
Output Voltage	0 – 75, 0 – 100, or 0 – 150 VDC (Limit Switch Dependent)
Output Current Limit (Max)	60 mA
Output Noise ⁵	1.5 mV _{rms} (~9.9 mV _{pp})
Output Impedance (Max)	150 Ω , 1.0 nF
Min Load Impedance ⁶	2.5 k Ω
Output Voltage Range (Switch Selectable)	
Voltage Limit Position (75 V)	0 – 75 VDC
Voltage Limit Position (100 V)	0 – 100 VDC
Voltage Limit Position (150 V)	0 – 150 VDC
External Input Gain	
Voltage Limit Position (75 V)	7.5 V/V ($\pm 5\%$)
Voltage Limit Position (100 V)	10 V/V ($\pm 5\%$)
Voltage Limit Position (150 V)	15 V/V ($\pm 5\%$)
Scan Trim Gain Adjustment	80% to 120% of Master Scan Ext + Int
Bandwidth (-3 dB)	
No Load, Small Signal ⁷	9 kHz
No Load, 150 V _{pp} ⁷	8.5 kHz
1.4 μ F Piezo, 150 V _{pp}	200 Hz
Stability	<0.01% over 5 hours
A/D and D/A Performance	
D/A Resolution	16-Bit / 2.75 mV
A/D Resolution	16-Bit / 3.0 mV
Communications	USB 2.0

⁵ The MDT693B and MDT694B were tested without an external load connected (1 nF output impedance only). Adding a capacitive load, such as a piezo, will decrease the noise spec since the capacitance will create a low-pass filter with the output resistance.

⁶ The Min Load Impedance represents the smallest allowable terminating resistance. Applying lower impedances will cause the short-circuit protection to limit the output voltage. Continued use in this mode will cause circuit degradation and eventual circuit failure.

⁷ Assume a ramp function is used. The bandwidth is load-dependent and requires calculation for a more representative number. See Chapter 6, page 13 for details.

Connections and Controls	
Interface Control	Optical Encoder with Push Button
Display	4-Digit, 7-Segment LED
Input Power Connection	IEC Connector
Input/Output Connectors	BNC (Male)
Power On	Rocker Switch
Scan Trim Controls	4-Turn Potentiometer
Remote Interface	USB Type B

Physical Specifications	
Display Type	7-Segment LED with 4 Digits
Number of Displays	
MDT693B	3
MDT694B	1
Display Resolution	0.1 V
Number of Channels	
MDT693B	3
MDT694B	1
Dimensions	
MDT693B	12.18" x 4.15" x 8.55" (309.4 x 105.5 x 217.1 mm)
MDT694B	6.05" x 3.22" x 12.11" (153.6 x 81.8 x 307.6 mm)
Weight	
MDT693B	3.02 kg (6.65 lbs)
MDT694B	1.93 kg (4.25 lbs)

Chapter 9 Mechanical Drawings

9.1. MDT693B Mechanical Drawing

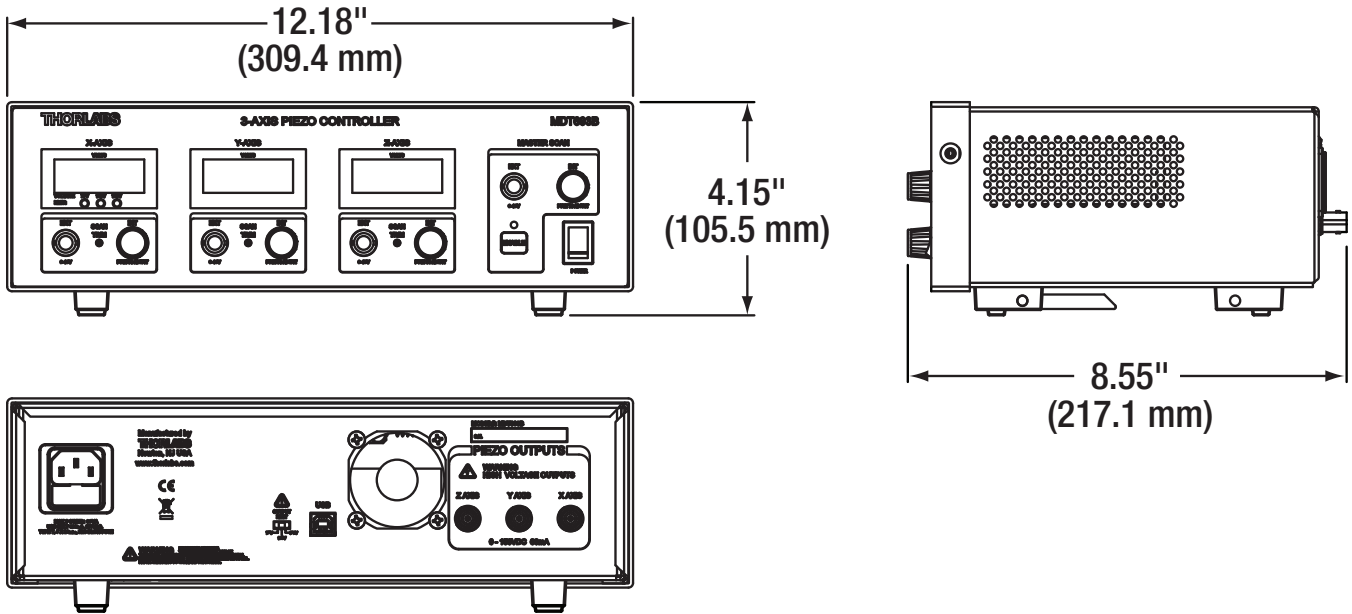

9.2. MDT694B Mechanical Drawing

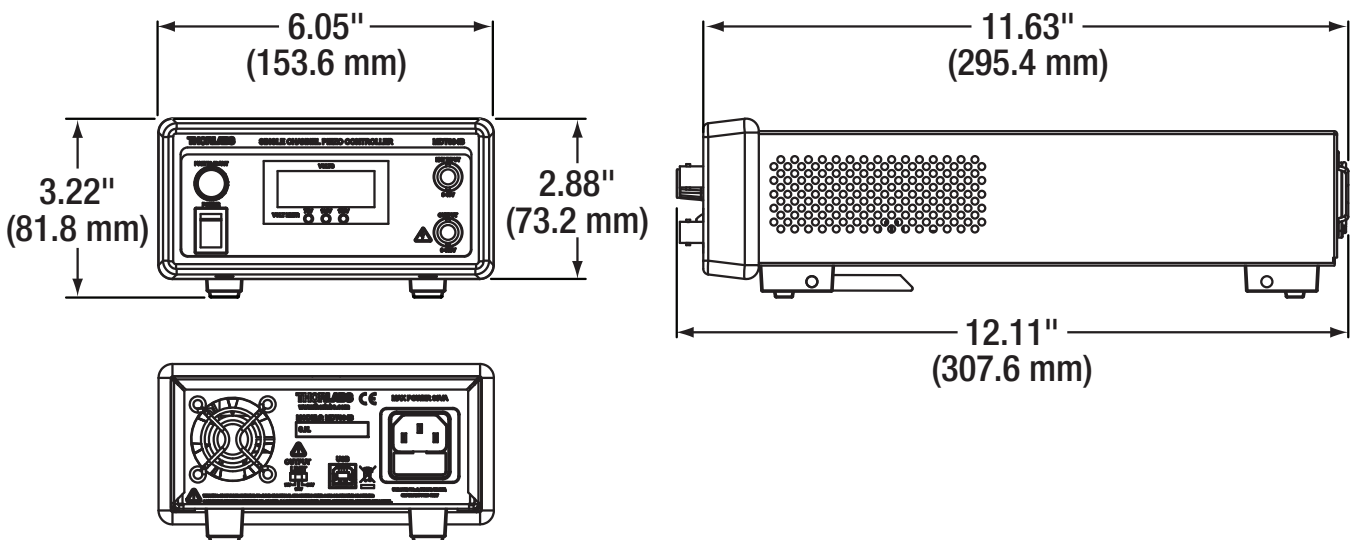

Chapter 10 Troubleshooting

The following table describes some typical problems that may be encountered while using the MDT69xB and possible solutions to these problems.

Problem	Solution
Unit does not turn on when switching the power switch to the ON position.	<ol style="list-style-type: none"> 1. Make sure the AC line cord is fully inserted into the AC input receptacle and plugged into an outlet providing 100 to 240 VAC. 2. Fuse(s) may be open. Refer to Section 4.2 for information on replacing open fuses. If the problem persists, please return the unit to Thorlabs for evaluation.
I cannot adjust the voltage.	<ol style="list-style-type: none"> 1. Make sure the correct channel is selected. Adjust the voltage by pushing in the INT knob. Adjustment can only occur when the display is blinking.
I can't connect to the MDT693B/MDT694B over the USB port.	<ol style="list-style-type: none"> 1. Make sure the unit is turned on prior to connecting the USB. 2. Power off unit, remove AC cord, remove the USB cable, reattach AC cord, power on unit and reattach the USB cable. 3. Make sure USB drivers are installed.
The output voltage is 0 V even when adjusting.	<ol style="list-style-type: none"> 1. Turn the power off. 2. Unplug your piezo device. 3. Turn the unit back on and retest. 4. Piezos tend to fail as a short circuit, causing the output current limit protection circuit to attenuate the output.

Chapter 11 Warranty

Thorlabs, Inc. warrants the material and production of the MDT69xB Piezo Controller for a period of 24 months from the date of shipment. During this warranty period, Thorlabs, Inc. will repair or exchange any units found to be defective in material or workmanship.

For warranty repairs or service, the unit must be returned to Thorlabs, Inc. or one of our worldwide offices. All returns must be accompanied by a Returned Material Authorization (RMA) number issued by Thorlabs. The customer is responsible for all costs incurred to ship the unit back to Thorlabs; in the case of warranty repairs, Thorlabs will cover the cost of shipment back to the customer.

In the case of shipments from outside of the United States, duties, taxes etc. shall be the responsibility of the customer.

Thorlabs, Inc. warrants all firmware and software used for the MDT69xB to operate fault-free, provided they are used in accordance with the requirements stated in this manual. However, Thorlabs does not warrant a fault-free operation for special applications.

Thorlabs, Inc. does not guarantee that this manual is error free and reserves the right to change this manual, the specifications, or the data of the described unit at any time, without notice.

Thorlabs, Inc. is not liable for any incidental damage caused by failure of this unit.

This warranty does not cover errors in operation, defects, or damage caused by the use of software not supplied by Thorlabs, modifications or misuse, or damage caused if the unit is used outside the operating parameters specified in this manual.

This warranty does not cover failure due to incorrectly connected heater and/or sensor elements, or failure of heater and/or sensor elements.



ATTENTION



The MDT69xB is not intended for use in medical and/or life support situations.

Chapter 12 Regulatory

As required by the WEEE (Waste Electrical and Electronic Equipment Directive) of the European Community and the corresponding national laws, Thorlabs offers all end users in the EC the possibility to return “end of life” units without incurring disposal charges.

- This offer is valid for Thorlabs electrical and electronic equipment:
- Sold after August 13, 2005
- Marked correspondingly with the crossed out “wheelie bin” logo (see right)
- Sold to a company or institute within the EC
- Currently owned by a company or institute within the EC
- Still complete, not disassembled and not contaminated



Wheelie Bin Logo

As the WEEE directive applies to self-contained operational electrical and electronic products, this end of life take back service does not refer to other Thorlabs products, such as:

- Pure OEM products, that means assemblies to be built into a unit by the user (e. g. OEM laser driver cards)
- Components
- Mechanics and optics
- Left over parts of units disassembled by the user (PCB's, housings etc.).

If you wish to return a Thorlabs unit for waste recovery, please contact Thorlabs or your nearest dealer for further information.

12.1. Waste Treatment is Your Own Responsibility

If you do not return an “end of life” unit to Thorlabs, you must hand it to a company specialized in waste recovery. Do not dispose of the unit in a litter bin or at a public waste disposal site.

12.2. Ecological Background

It is well known that WEEE pollutes the environment by releasing toxic products during decomposition. The aim of the European RoHS directive is to reduce the content of toxic substances in electronic products in the future.

The intent of the WEEE directive is to enforce the recycling of WEEE. A controlled recycling of end of life products will thereby avoid negative impacts on the environment.

Chapter 13 Certifications and Compliance

Konformitätserklärung Declaration of Conformity Déclaration de Conformité

**Thorlabs Inc
56 Sparta Ave.
Newton, NJ
USA**

erklärt in alleiniger Verantwortung, dass das Produkt:
declares under it's own responsibility, that the product:
declare sous notre seule responsabilité, que le produit:

MDT693B & MDT693B-EC

mit den Anforderungen der Normen
fulfills the requirements of the standard
satisfait aux exigences des normes

2006/95 EC	Low Voltage Directive 12.Dec. 2006
EMC 2004/108/EC	Electromagnetic Compatibility Directive
EN 61010-1:2001	Safety of Test and Measurement Equipment
EN 61326-1:2006	EMC of Test and Measurement Equipment
CISPR 11 Edition 4:2003	Conducted Emissions
CISPR 11 Edition 4:2003	Radiated Emissions
IEC 61000-3-2,	Harmonics
IEC 61000-3-3	Voltage Fluctuation and Flicker
IEC 61000-4-2	Electrostatic Discharge
IEC 61000-4-3	Radiated Immunity
IEC 61000-4-4	Electrical Fast Transient/Burst, Power Leads
IEC 61000-4-4	Electrical Fast Transient/Burst, I/O Leads
IEC 61000-4-5	Surge Immunity, Power Leads
IEC 61000-4-6	Conducted Immunity, Power Leads
IEC 61000-4-6	Conducted Immunity, I/O Leads
IEC 61000-4-11	Voltage Dips, Interrupts and Variations

übereinstimmt und damit den Bedingungen entspricht.
and therefore corresponds to the regulations of the directive.
et répond ainsi aux dispositions de la directive.

Dachau, 21. Juni 2013

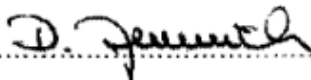
.....

Ort und Datum der Ausstellung
Place and date of issue
Lieu et date d'établissement

Name und Unterschrift des Befugten
Name and signature of authorized person
Nom et signature de la personne autorisée

**Konformitätserklärung
Declaration of Conformity
Déclaration de Conformité**

**Thorlabs Inc
56 Sparta Ave.
Newton, NJ
USA**

erklärt in alleiniger Verantwortung, dass das Produkt:
declares under it's own responsibility, that the product:
declare sous notre seule responsabilité, que le produit:

MDT694B & MDT694B-EC

mit den Anforderungen der Normen
fulfills the requirements of the standard
satisfait aux exigences des normes

2006/95 EC
EMC 2004/108/EC
EN 61010-1:2001
EN 61326-1:2006
CISPR 11 Edition 4:2003
CISPR 11 Edition 4:2003
IEC 61000-3-2,
IEC 61000-3-3
IEC 61000-4-2
IEC 61000-4-3
IEC 61000-4-4
IEC 61000-4-4
IEC 61000-4-5
IEC 61000-4-6
IEC 61000-4-6
IEC 61000-4-11

Low Voltage Directive 12.Dec. 2006
Electromagnetic Compatibility Directive
Safety of Test and Measurement Equipment
EMC of Test and Measurement Equipment
Conducted Emissions
Radiated Emissions
Harmonics
Voltage Fluctuation and Flicker
Electrostatic Discharge
Radiated Immunity
Electrical Fast Transient/Burst, Power Leads
Electrical Fast Transient/Burst, I/O Leads
Surge Immunity, Power Leads
Conducted Immunity, Power Leads
Conducted Immunity, I/O Leads
Voltage Dips, Interrupts and Variations

übereinstimmt und damit den Bedingungen entspricht.
and therefore corresponds to the regulations of the directive.
et répond ainsi aux dispositions de la directive.

Dachau, 21. Juni 2013

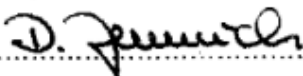
.....

Ort und Datum der Ausstellung
Place and date of issue
Lieu et date d'établissement

Name und Unterschrift des Befugten
Name and signature of authorized person
Nom et signature de la personne autorisée

Chapter 14 Thorlabs Worldwide Contacts

For technical support or sales inquiries, please visit us at www.thorlabs.com/contact for our most up-to-date contact information.



USA, Canada, and South America

Thorlabs, Inc.
sales@thorlabs.com
techsupport@thorlabs.com

Europe

Thorlabs GmbH
europe@thorlabs.com

France

Thorlabs SAS
sales.fr@thorlabs.com

Japan

Thorlabs Japan, Inc.
sales@thorlabs.jp

UK and Ireland

Thorlabs Ltd.
sales.uk@thorlabs.com
techsupport.uk@thorlabs.com

Scandinavia

Thorlabs Sweden AB
scandinavia@thorlabs.com

Brazil

Thorlabs Vendas de Fotônicos Ltda.
brasil@thorlabs.com

China

Thorlabs China
chinasales@thorlabs.com



THORLABS
www.thorlabs.com
