

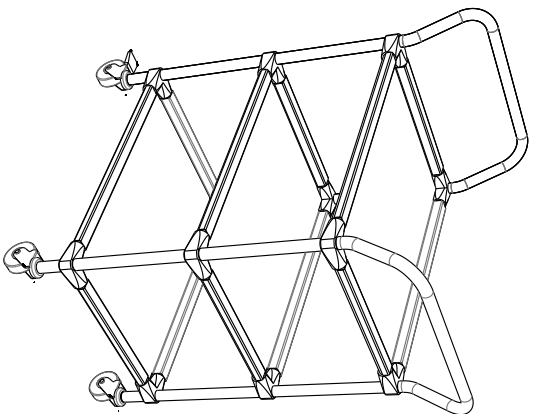

VIKING



НАУЧНОЕ
ОБОРУДОВАНИЕ
ГРУППА КОМПАНИЙ



2X

TT-XX.00.01

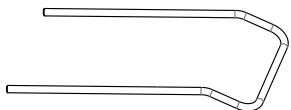

3X

TT-XX.00.01

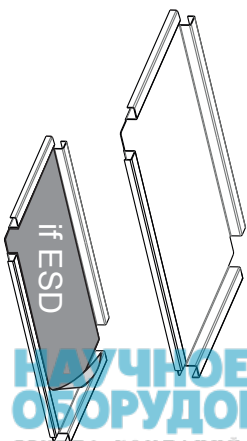

6X







TT-XX.00.03

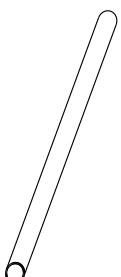

6X

TT-XX.00.02



4X 1.1.912.10x20 	4X 1.4.127.10 	12X 2.4.3.1 	2X 2.2.1S  if ESD 2.2.5S	2X 2.2.2  if ESD 2.2.6	1X 3.1.1.1 	1X 3.1.1.2 
--	---	---	---	---	--	--

1

X2

2.4.3.1

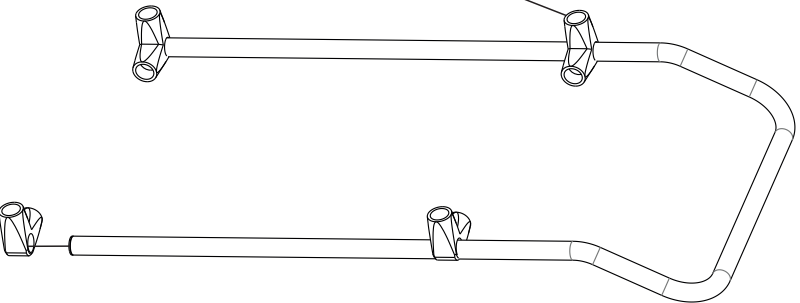

2 X3

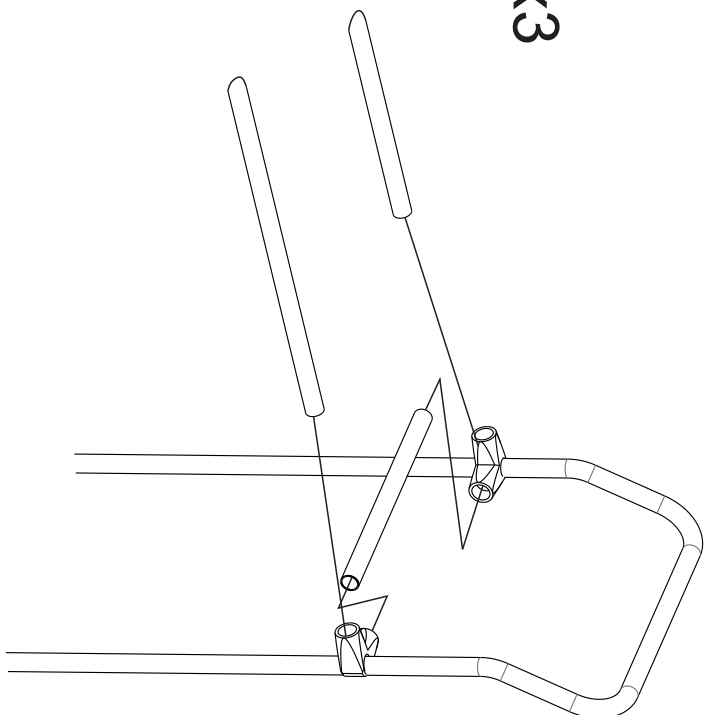

3

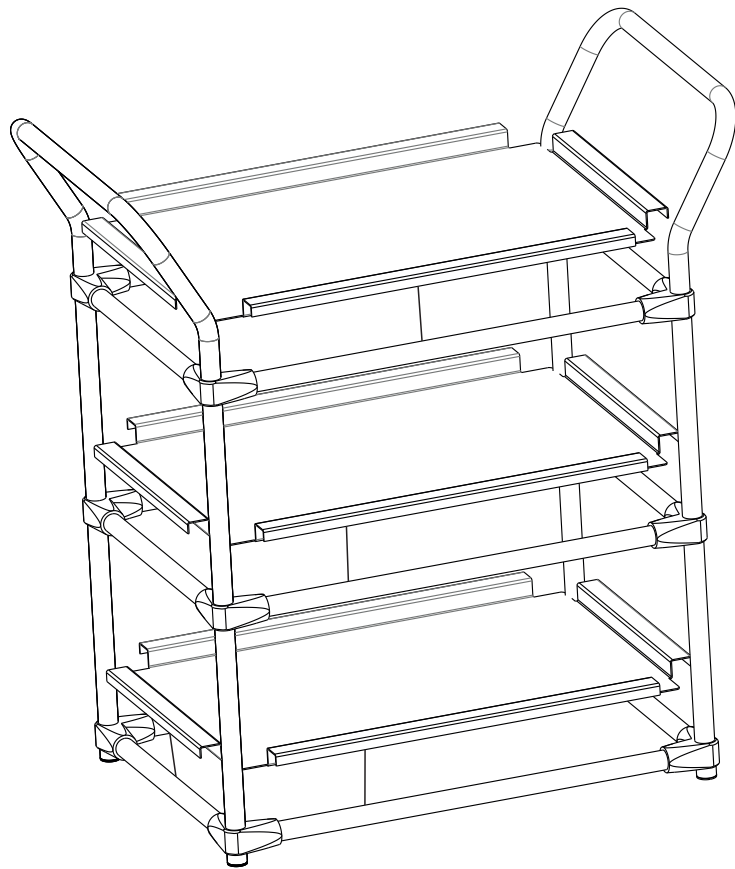

4



2.2.1S

1.4.127.10

1.1.912.10x16

2.2.2

5

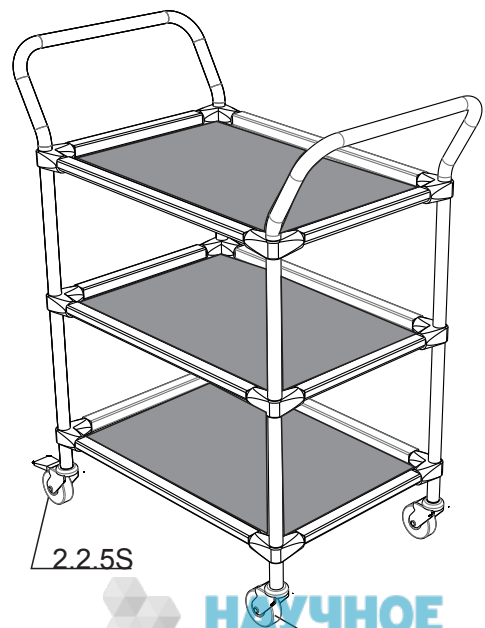

2.2.5S

2.2.6