

RIGOL

User's Guide

DS1000B Series Digital Oscilloscopes

DS1074B,DS1104B,DS1204B

Feb. 2014

RIGOL Technologies, Inc.

Guaranty and Declaration

Copyright

© 2009 RIGOL Technologies, Inc. All Rights Reserved.

Trademark Information

RIGOL is registered trademark of **RIGOL** Technologies, Inc.

Publication Number

UGA04120-1210

Notices

- **RIGOL** products are protected by patent law in and outside of P.R.C..
- **RIGOL** Technologies, Inc. reserves the right to modify or change parts of or all the specifications and pricing policies at company's sole decision.
- Information in this publication replaces all previously corresponding material.
- **RIGOL** shall not be liable for losses caused by either incidental or consequential in connection with the furnishing, use or performance of this manual as well as any information contained.
- Any part of this document is forbidden to copy or photocopy or rearrange without prior written approval of **RIGOL**.

Product Certification

RIGOL guarantees this product conforms to the national and industrial standards in China as well as the ISO9001:2008 standard and the ISO14001:2004 standard. Other international standard conformance certification is in progress.

Contact Us

If you have any problem or requirement when using our products or this manual, please contact **RIGOL**.

E-mail: service@rigol.com

Websites: www.rigol.com

Safety Notices

view the following safety precautions carefully before operating the instrument to avoid any personal injuries or damages to the instrument and any products connected to it. To avoid potential hazards use the instrument as specified by this user's guide only.

The instrument should be serviced by qualified personnel only.

To Avoid Fire or Personal Injury.

Use Proper Power Cord.

Use the power cord designed for the instrument and authorized in your country only.

Ground The Instrument.

The oscilloscope is grounded through the grounding conductor of the power cord. To avoid electric shock the instrument grounding conductor(s) must be grounded properly, before making connections to the input or output terminals of the instrument.

Connect The Probe.

The probes' ground terminals are at the same voltage level of the instrument ground. Do not connect the ground terminals to a high voltage.

Observe All Terminal Ratings.

To avoid fire or shock hazard, observe all ratings and marks on the instrument. Follow the user's guide for further ratings information before making connections to the instrument.

Do Not Operate Without Covers.

Do not operate the instrument with covers or panels removed.

Use Proper Fuse.

Use the fuse of the type, voltage and current ratings as specified for the instrument.

Avoid Circuit or Wire Exposure.

Do not touch exposed connections and components when power is on.

Do Not Operate With Suspected Failures.

If suspected damage occurs with the instrument, have it inspected by qualified service personnel before further operations.

Provide Proper Ventilation.

Refer to the installation instructions for proper ventilation of the instrument.

Do Not Operate in Wet Conditions

In order to avoid short circuiting to the

interior of the device or electric shock, please do not operate in a humid environment.

Do Not Operate in an Explosive Atmosphere

In order to avoid damages to the device or personal injuries, it is important to operate the device away from an explosive atmosphere.

Keep Product Surfaces Clean and Dry

To avoid the influence of dust and/or moisture in air, please keep the surface of device clean and dry.

The disturbance test of all the models meet the limit values of A in the standard of EN 61326: 1997+A1+A2+A3, but can't meet the limit values of B.

Measurement Category

The DS1000B series Digital Oscilloscope is intended to be used for measurements in Measurement Category I.

Measurement Category Definitions

Measurement Category I is for measurements performed on circuits not directly connected to MAINS. Examples are measurements on circuits not derived from MAINS, and specially protected (internal) MAINS derived circuits. In the latter case, transient stresses are variable; for that reason, the transient withstand capability of the equipment is made known to the user.

WARNING

IEC Measurement Category I, the input terminals may be connected to circuit terminal in IEC Category I installations for voltages up to 300 VAC. To avoid the danger of electric shock, do not connect the inputs to circuit's voltages above 300 VAC.

Transient overvoltage is also present on circuits that are isolated from mains. The DS1000B series Digital Oscilloscopes is designed to safely withstand occasional transient overvoltage up to 1000 Vpk. Do not use this equipment to measure circuits where transient overvoltage could exceed this level.

Safety Terms and Symbols

Terms in this Manual. These terms may appear in this manual:



WARNING

Warning statements indicate the conditions or practices that could result in injury or loss of life.



CAUTION

Caution statements indicate the conditions or practices that could result in damage to this product or other property.

Terms on the Product. These terms may appear on the product:

DANGER indicates an injury or hazard that may immediately happen.

WARNING indicates a potential injury or hazard that may immediately happen.

CAUTION indicates a potential damage to the instrument or other property that may occur.

Symbols on the Product. These symbols may appear on the product:



Hazardous Voltage



Safety Warning



Protective Earth Terminal



Chassis Ground



Test Grounding

General-Purpose Oscilloscopes

The introduction of this document contains three types of DS1000B series oscilloscope: DS1074B, DS1104B and DS1204B

RIGOL DS1000B series digital oscilloscopes with four analog channels in connection with an external trigger channel are designed to capture multiple signals and meet the needs of measurement along with its excellent performance, powerful functions.

The instrument is designed for 2GSa/s maximum real-time sample rate, 50GSa/s maximum equivalent sample rate and 200MHz maximum bandwidth. Besides, abundant trigger modes, math and acquire functions enable it easy to capture and analyze waveforms, also, **Auto** button is available to display a signal automatically.

What's more, the laconic and clear panel in line with tradition and the intuitive on the panels make instrument operation easy and convenient, as well as the LCD, interface and buttons are all friendly and clear, making operation more comfortable.

Main Features:

- Four Channels, Bandwidth of per channel:
200MHz: DS1204B
100MHz: DS1104B
70MHz: DS1074B
- 2GSa/s real-time sampling rate and 50GSa/s equivalent sampling rate.
- Color TFT 5.7 inch LCD, 320×240 pixels resolution.
- USB storage and PictBridge printing.
- Available to interconnect with **RIGOL** signal generator seamlessly.
- Adjustable waveform intensity, more effective waveform viewing.
- One-touch automatic setup, ease of use (AUTO).
- Storage and recurrence of Waveforms and setups, supports CSV, 8 or 24 bits bitmap and PNG format.
- Delayed Scan Function, easy to give attention to both details and overview of a waveform.
- 22 Automatic measurements.

RIGOL

- Automatic cursor tracking measurements.
- Waveform recorder, record and replay dynamic waveforms.
- Built-in FFT function.
- Digital filters, includes LPF, HPF, BPF, BRF.
- Pass/Fail detection Function, optically isolated Pass/Fail output.
- Addition, Subtract and Multiply Mathematic Functions of waveforms.
- Advanced trigger types include: Edge, Video, Pulse width, Pattern, Alternative.
- Adjustable trigger sensitivity.
- Multiple Language User Interface.
- Pop-up menu makes it easy to read and easy to use.
- Built-in help systems with multinational languages.
- Easy-to-use file system supports Chinese & English characters file name input.
- Conform to LXI consortium instrument standard class C.

Document Overview

Chapter 1 Quick Start

To introduce the panels and menus to help users to realize the base operations.

Chapter 2 Operating Your Oscilloscope

More details to help users to understand the functions and measurements of instrument deeply.

Chapter 3 Application Examples

To show the measurement functions directly by application examples.

Chapter 4 Troubleshooting

Provide you troubleshooting to solve the problems during operating.

Chapter 5 Specifications

List common specifications and characteristics of the oscilloscope.

Chapter 6 Appendix

Information about accessories, warranties, services and supports and the like.

Contents

Guaranty and Declaration	I
Safety Notices.....	II
General-Purpose Oscilloscopes	V
Chapter 1 Quick Guide	1-1
General Inspect	1-2
Panels and User Interface	1-3
Functional Check.....	1-7
To Compensate the Probes	1-9
To Display a Signal Automatically.....	1-10
To Understand the Vertical System	1-11
To Understand the Horizontal System	1-13
To Understand the Trigger System.....	1-15
To Understand the Quick Function	1-17
Chapter 2 Operating Your Oscilloscope	2-1
To Set up the Vertical System	2-2
Channel Settings	2-4
Math Function	2-14
REF Function.....	2-20
To Set up the Horizontal System.....	2-28
Delayed Scan	2-31
X-Y Format.....	2-32
To Set up the Trigger System.....	2-33
Edge Trigger	2-34
Pulse Width Trigger.....	2-35
Video Trigger.....	2-36
Pattern Trigger	2-39
Alternative Trigger	2-41
Trigger Settings.....	2-44
To Set up the Sampling System	2-50
To Set up the Display System.....	2-54
To Store and Recall	2-57
To Set up the Utility	2-66
The I/O Setup	2-68
Language	2-76
Pass/Fail	2-77

Waveform Recorder	2-80
Print Setting	2-84
Self-Calibration	2-88
System Information	2-89
Date and Time	2-91
To Measure Automatically	2-92
Quick Measurement Setup	2-94
Delay/Phase Setup	2-95
Voltage Measurements	2-96
Time Measurements	2-98
To Measure with Cursors	2-101
Manual Mode	2-102
Track Mode	2-104
Auto mode	2-106
To Use Run Control Buttons	2-107
Chapter 3 Application Examples	3-1
Example 1: Taking Simple Measurements	3-1
Example 2: View a Signal Delay Caused by a Circuit	3-2
Example 3: Capture a Single-Shot Signal	3-3
Example 4: To Reduce the Random Noise on a Signal	3-4
Example 5: Making Cursor Measurements	3-6
Example 6: The Application of the X-Y operation	3-8
Example 7: Triggering on a Video Signal	3-10
Example 8: FFT Cursor Measurement	3-12
Example 9: Pass/Fail Test	3-13
Chapter 4 Troubleshooting	4-1
Chapter 5 Specifications	5-1
Technical Specifications	5-2
General Specifications	5-7
Chapter 6 Appendixes	6-1
Appendix A: DS1000B series Accessories	6-1
Appendix B: Warranty	6-2
Appendix C: General Care and Cleaning	6-3
Appendix D: Any Comment or Question?	错误! 未定义书签。
Index	1

Chapter 1 Quick Guide

This chapter covers the following topics:

- General Inspect
- Panels and User Interface
- Functional Check
- To Compensate the Probes
- To Display a Signal Automatically
- To Understand the Vertical System
- To Understand the Horizontal System
- To Understand the Trigger System
- To Understand the Quick Function

General Inspect

After receiving a new DS1000B series oscilloscope, please inspect the instrument as follows:

1. Inspect the shipping container for damage.

Keep the damaged shipping container or cushioning material until the contents of the shipment have been checked for completeness and the instrument has passed both electrical and mechanical test.

The consigner or carrier shall be liable for the damage to instrument resulting from shipment, without free maintenance or replacement by **RIGOL**.

2. Inspect the instrument.

In case of any damage, or defect, or failure, notify your **RIGOL** Sales Representative.

3. Check the accessories.

Accessories supplied with the instrument are listed in "Appendix A: DS1000B series Accessories" in this guide.

If the contents are incomplete or damaged, please notify your **RIGOL** Sales Representative.

Panels and User Interface

Being familiar with the operation panels is the first priority when you get a new DS1000B series digital oscilloscope. This chapter will bring you a brief introduction and description of the panels and functions of oscilloscope, which can help users to know well about the instrument in a short time.

Front Panel

Figure 1-1, the front Panel; the knobs are used most often and are similar to the knobs on other oscilloscopes. There are five grey buttons defined as No.1 to No.5 from up to bottom on the right side of the display which are menu operating buttons. The buttons not only allow you to use some of the functions directly but also bring up soft button menus on the screen, which enable the access to many measurement features associated with the advanced functions, mathematics, and reference or to run control features.

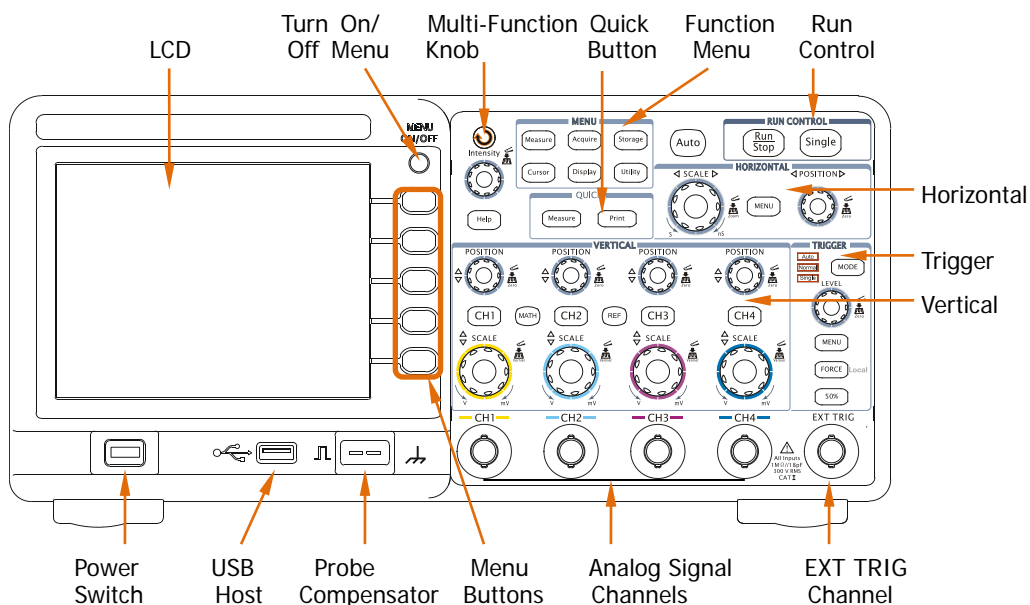

Figure 1-1 Front Panel Overview

Front Panel Interfaces:

USB Host: Connect DS1000B with external USB devices when the oscilloscope is regarded as “Host Device”, such as connecting a USB flash device.

Analog Signal Channels: Four channels are provided: CH1, CH2, CH3 and CH4.

EXT TRIG Input: It is applied to input external trigger signal.

NOTE: There are two USB Host ports respectively on the front and rear panel.

Rear Panel





Figure 1-2 Rear Panel Overview

Rear Panel of DS1000B contains the following parts:

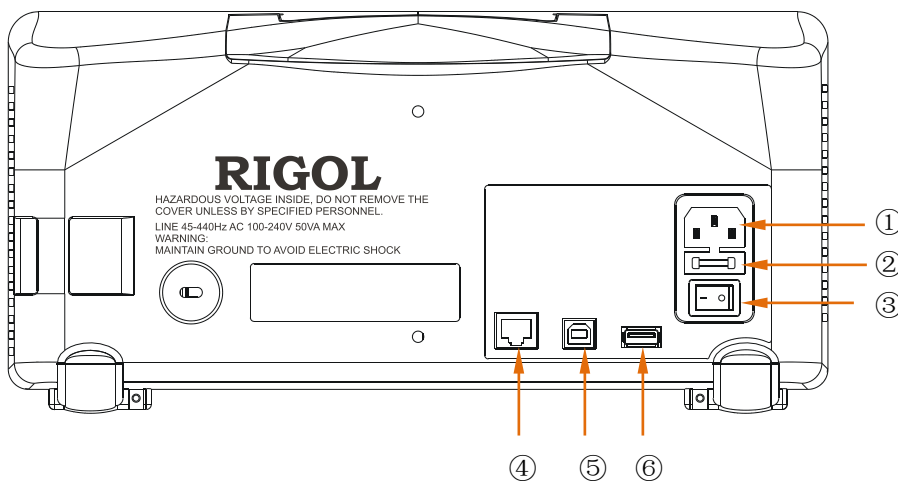
- ① **Power Supply:** Input power supply to the instrument.
- ② **Fuse:** 250V, T2A
- ③ **Power Switch:** Turn on or off the power source.
- ④ **LAN:** Enable users to set up network by LAN port.
- ⑤ **USB Device:** Connect DS1000B with external USB devices when the oscilloscope is regarded as “Slave Device”. For example: connect with PC for remote control.
- ⑥ **USB Host:** Connect DS1000B with external USB devices when the oscilloscope is regarded as “Host Device”, such as connecting a USB flash device.

Notation definitions in this Manual:

Throughout this guide, notation symbols of buttons and knobs are the same of those on front-panel.

- A box around the name of the key denotes MENU function buttons on front-panel, such as Measure.
-  denotes the multi-function knob .
-  POSITION denotes the five POSITION knobs.
-  SCALE denotes the five SCALE knobs.
-  LEVEL denotes the LEVEL knob.
- The name with a drop shadow denotes the menu operating key, such as Waveform soft key in Storage menu.
- Arrow "→" is used to divide operation steps. Such as: Storage → Storage, indicates press "Storage" button on the front panel, then press "Storage" menu.

User Interface

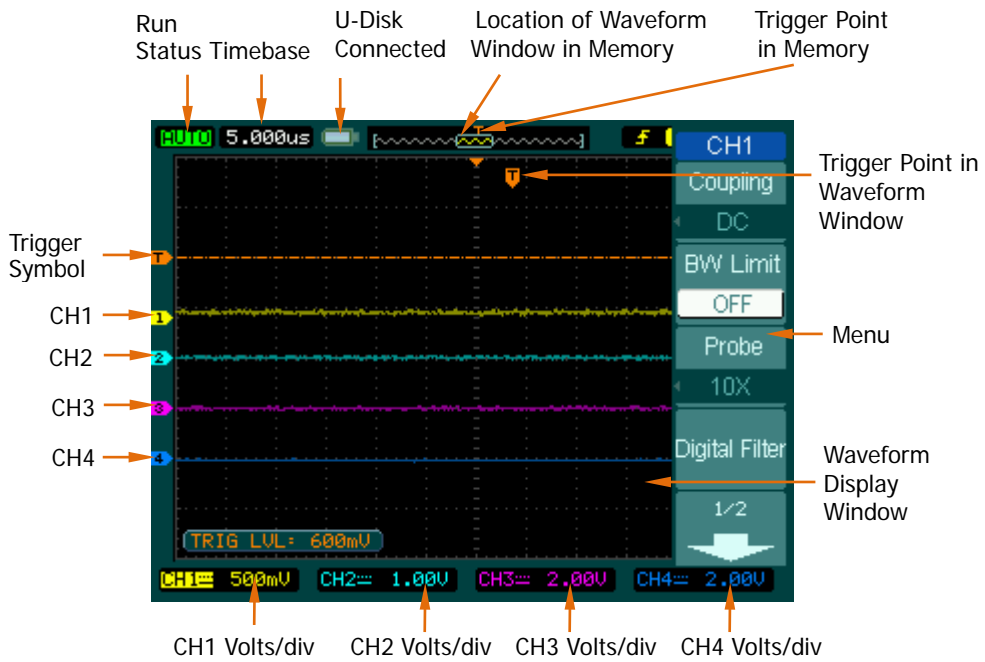

Figure 1-3 User Interface Overview

Functional Check

Perform this quick functional check to verify that the instrument is operating correctly.

1. Turn on the instrument

Use the power cord designed for the oscilloscope only to connect the instrument and AC power which delivers 100 to 240 VAC_{RMS}, 45Hz to 440Hz. Press the power switch to turn on the instruments, waiting until the display shows the waveform window.

2. Recall factory setting

Press **Storage** → **Storage** → **Factory** → **Recall**, to recall factory setting.

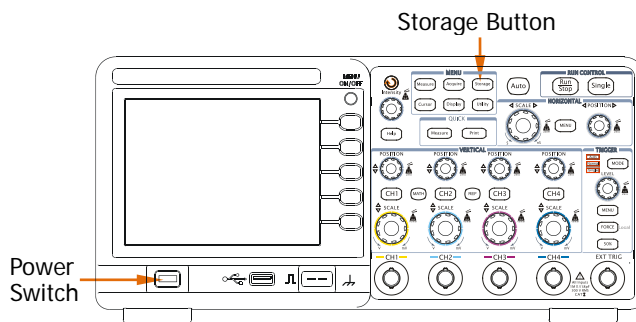

Figure 1-4 Button explanation



WARNING

To avoid electric shock, be sure the oscilloscope is properly grounded.

3. Input a signal to a channel of the oscilloscope

- Push BNC plug of probe into CH1 BNC connector, then twist the BNC cable to right to lock the probe in place. Switch on the probe to 10X.
- Press **CH1** → **Probe** → **10X** to set probe attenuation of the oscilloscope, so as to make sure the measurement result is correct. (Default probe attenuation scale is 1X.)

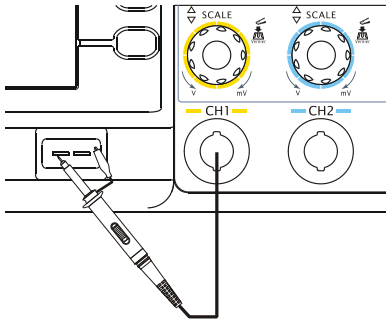

Figure 1-5 Probe connection

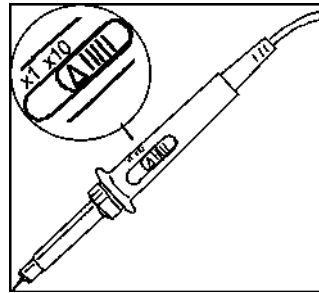

Figure 1-6 Probe adjustment

- Attach the probe tip to the Probe compensator connector and the reference lead to the ground pin. Press **Auto**, within a few seconds, a square wave will display (approximately 1kHz, 3Vpp).
- Push the **OFF** button or push the **CH1** button again to turn off Channel 1. Push the **CH2**, **CH3**, **CH4** buttons to turn on other channels, repeat step 2&3.

NOTE: Signal outputed from the Probe compensator is ONLY used for probe compensation, not for calibration.

To Compensate the Probes

Perform this adjustment to match the characteristics of the probe and the channel input. This should be performed whenever attaching a probe to any input channel at the first time.

1. From CH1 menu, set the Probe attenuation to 10X (press **CH1**→**Probe**→**10X**). Set the switch to 10X on the probe and connect it to CH1 of the oscilloscope. When using the probe hook-tip, inserting the tip into the hook-tip firmly to ensure a tight connection.
2. Attach the probe tip to the connector of the Probe compensator and link the reference wire cramp with the ground connector of the probe compensator, Select CH1, and then press **Auto**.
3. Check the shape of the displayed waveform.

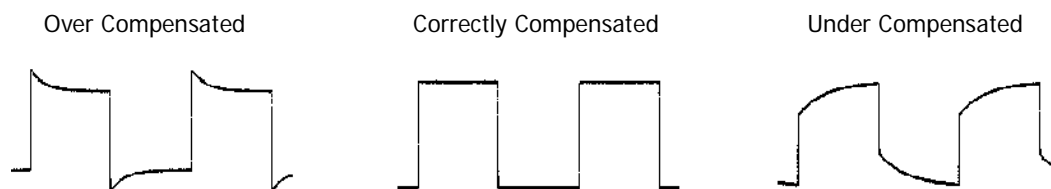

Figure 1-7 Compensate waveform

4. If necessary, use a non-metallic tool to adjust the variable capacitor of the probe for the flattest square wave being displayed on the oscilloscope.
5. Repeat if necessary.



WARNING

To avoid electric shock while using the probe, be sure the perfection of the insulated cable, and do not touch the metallic portions of the probe head while it is connected with a voltage source.

To Display a Signal Automatically

The oscilloscope has an automated feature to display the input signal in best-fit status. The input signal should be 50 Hz or higher and a duty cycle is greater than 1%.

Using the automatic setting:

1. Connect a signal to the oscilloscope (such as channel 1) as described above.
2. Press **Auto**.

The oscilloscope may change the current settings to display the signal; adjusts the vertical and horizontal scaling, the trigger coupling, type, position, level, and mode.

To Understand the Vertical System

As shown in Figure 1-8, there are several buttons and knobs in the **VERTICAL** control area, which are used for setting Channels, MATH and REF functions as well as adjusting vertical position and Volts/div of waveforms. In addition, different colors are designed for different channels, corresponding to different waveforms, so as to observe clearly.

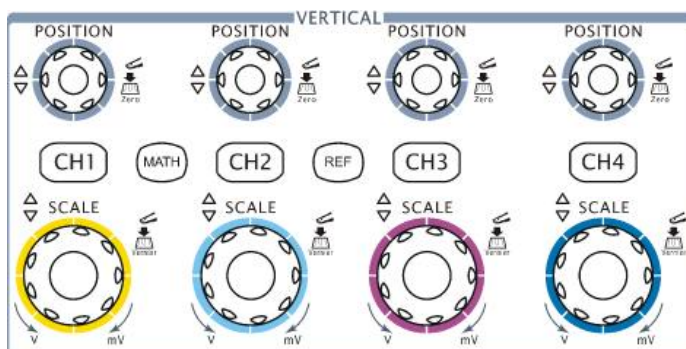

Figure 1-8 Vertical control



1. Press **CH1**, **CH2**, **CH3**, **CH4**, **MATH**, **REF**, the operating menus, symbols, waveforms and status information of corresponding channel and settings will be displayed on the screen. The current selected channel will be shut down when you press the key associated with the channel one more time.
2. Set vertical position of waveform display by **POSITION** knob.
Turning the **POSITION** knob, a voltage value is displayed for a short time indicating its value with respect to the ground reference located at the center of the screen. Also notice that the ground symbol on the left side of the display moves in conjunction with the **POSITION** knob.

Measurement hints

If the channel is DC coupled, measuring the DC components of the signal by simply noting its distance from the ground symbol.

If the channel is AC coupled, the DC component of the signal is blocked, allow you to use greater sensitivity to display the AC component of the signal.

Vertical offset back to 0 shortcut key

Turn the  POSITION knob to change the vertical display position of channel and press the  POSITION knob to set the vertical display position back to 0 as a shortcut key, this is especially helpful when the trace position is far out of the screen and want it to get back to the screen center immediately.

3. Set vertical "Volts/div" by  SCALE knob.

Rotate  SCALE to change "Volts/div", the change will be displayed in real time at the bottom of interface. Besides, the "Volts/div" contains two forms: "Fine" and "Coarse".

Coarse/Fine Shortcut key

The Coarse/Fine vertical control can be set by simply pressing the vertical  SCALE knob.

To Understand the Horizontal System

Figure1-9 shows the **HORIZONTAL** controls: **MENU** button, **POSITION** and **SCALE** knobs of horizontal system. Following the exercise to familiarize with the buttons, knobs, and status bar.

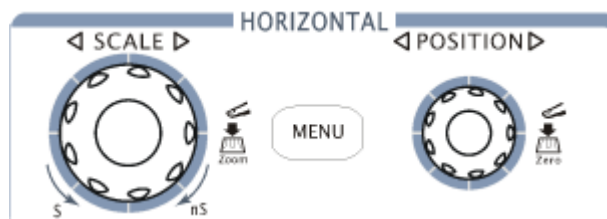

Figure 1-9 Horizontal control

1. Set horizontal "s/div" by **SCALE** knob.
The horizontal **SCALE** knob changes the sweep speed in a 1-2-5 step sequence, and displays the value at the upper-left of the display. The time base ranges of the DS1000B series is from 2 ns/div* to 50 s/div.

Delayed Scan Shortcut key

To press the **SCALE** knob in the horizontal control area on the front-panel is another way to enter or exit Delayed Scan mode and it is equal to the menu operations, **MENU** → Delayed → ON.

NOTE*: The speed of horizontal scan varies by different models.

2. Press **MENU** button to display the "Horizontal" menu. Users can set the delayed state, time base expansion, time base mode and trigger offset.

Term Explanations

Trig-Offset: Denotes the real position of the trigger point relative to the midpoint of the memory. In this setting, the trigger position will be changed horizontally when you turning the **POSITION** knob.

3. The horizontal  POSITION knob moves displayed signal horizontally on the waveform window.

The horizontal  POSITION knob adjusts the trigger offset of signal, when turning the knob; you can note that the waveform moves horizontally in conjunction with the knob.

Horizontal offset back to 0 shortcut key

Rotate the horizontal  POSITION knob to adjust the horizontal position of the signal in the waveform window and press it down to restore the trigger offset or (delayed sweep offset) to the zero point.

To Understand the Trigger System

Figure 1-10 shows the **TRIGGER** control: **MODE**, **MENU**, **FORCE**, **50%** and a **LEVEL** knob. Following the exercises to familiarize with the buttons, trigger level knob and status bar.

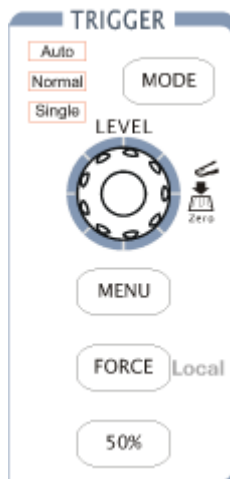

Figure 1-10 Trigger control

1. Three kinds of trigger modes can be switched among Auto, Normal and Single with pressing **MODE** button.
2. Use the **LEVEL** knob to change the settings of trigger level. Turning the **LEVEL** knob, you will observe an orange trigger line, a trigger sign and a trigger level value displaying pane on the screen moving up and down. When you stop turning the **LEVEL** knob, the trigger line, trigger sign and trigger value pane will disappear in five seconds. During the same time of moving the trigger line, you will notice that the displayed value of trigger level has been changed on the screen.

Trigger Level back to 0 Shortcut key

Turn the **LEVEL** knob to change the trigger level value and press the **LEVEL** knob to set trigger level back to 0 as a shortcut key.

3. Press **MENU** button in the Trigger control area.
A soft button menu appears on the display showing the trigger setting choices as shown in Figure 1-11.

Figure 1-11

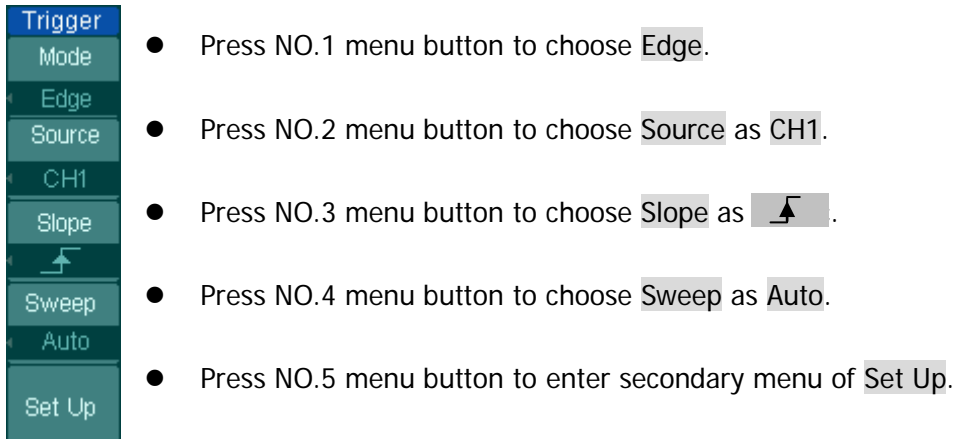

NOTE: The change of trigger mode, source selection and slope type will lead to the change of the status bar on the upper-right of the screen.

4. Press **FORCE**
Start an acquisition even if no valid trigger signal has been found, usually used in “Normal” or “Single” trigger mode. This button has no effect if the acquisition is already stopped.

Switch Local/Remote mode

Press **FORCE** button to switch the operation mode as “local” when the instrument is under remote mode.

5. Press **50%**
Press the **50%** button to set the trigger level to the center of the signal's amplitude.

To Understand the Quick Function

The following figure shows that there are two buttons in the **QUICK** function area. The exercise below will gradually conduct you to familiarize the settings of the buttons.

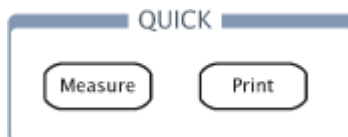

Figure 1-12
The quick function menu

1. **Measure**

There are two **Measure** buttons on the front panel, belonging to Function Menu area and Quick Function area respectively. Firstly, you need to pre-set up three items from 22 measurements via **Measure** → **QuickMea** from Function Menu area, and then press **Measure** as shown in figure 1-12 to enter quick measurement, three measuring parameters pre-defined will be displayed on the screen.

2. **Print**

Use **Print** button to perform a quick print or store data to USB flash device.

- To execute print operation if connecting the printer since it has a higher priority.
- To store the measurement results to USB flash device in current format such as Waveform, Setups, 8 Bitmap, 24 Bitmap, PNG or CSV. Furthermore, it will be stored as 8-Bitmap automatically when selecting "Factory".

Chapter 2 Operating Your Oscilloscope

By now, a user should understand the VERTICAL, HORIZONTAL and TRIGGER control systems and know how to determine the system setup from the status bar of a DS1000B series digital oscilloscope. This chapter will go through all groups of front-panel buttons, knobs and menus; and further the knowledge of the operation by hints in this guide. It is strongly recommended to perform all of the following exercises to get the most of the powerful measurement capabilities of the oscilloscope.

This chapter covers the following topics:

- To Set up the Vertical System (CH1, CH2, CH3, CH4, MATH, REF, Vertical POSITION, Vertical SCALE)
- To Set up the Horizontal System (MENU, Horizontal POSITION, Horizontal SCALE)
- To Set up the Trigger System (MODE, LEVEL, MENU, FORCE, 50%)
- To Set up the Sampling System (Acquire)
- To Set up the Display System (Display)
- To Store and Recall (Storage)
- To Set up the Utility (Utility)
- To Measure Automatically (Measure)
- To Measure with Cursors (Cursor)
- To Use Run Control Buttons (Auto, Run/Stop, Single)

Please read this chapter carefully to get more functions and operations about DS1000B series oscilloscopes.

To Set up the Vertical System



Four analog channels are provided by DS1000B: CH1, CH2, CH3 and CH4. Press the corresponding button on the front panel to turn the channels on/off. The backlight indicates the channel is currently active. Press the button again to turn the channel off. When channel is currently selected, press **OFF** will turn it off and the backlight goes off.





Table 2-1 Channels menu

Channel	Settings	Status Indicator
Channel 1 (CH1)	ON Selected OFF	CH1 (yellow letters with black background) CH1 (black letters with yellow background) No indicator
Channel 2 (CH2)	ON Selected OFF	CH2 (azure blue letters with black background) CH2 (black letters with blue background) No indicator
Channel 3 (CH3)	ON Selected OFF	CH3 (pink letters with black background) CH3 (black letters with pink background) No indicator
Channel 4 (CH4)	ON Selected OFF	CH4 (black letter with navy blue background) CH4 (navy blue letter with black background) No indicator
MATH	ON Selected OFF	MATH (purple letter with black background) MATH (black letter with purple background) No indicator

Other functions such as MATH and REF can be regarded as relatively isolated channels.

Knobs Explanation

Use the vertical controls to display signal waveforms by adjusting the vertical SCALE knob, and the POSITION knob, and setting the input parameters.

1. Using vertical POSITION knob.
The vertical POSITION control changes the vertical position of signal waveforms in all channels (excluding MATH and REF). The resolution changes according to the vertical level set. Pressing this knob will clear the channel's vertical offset to zero.
2. Using vertical SCALE knob.
The vertical SCALE control changes the vertical sensitivity of signal waveforms in all channels (excluding MATH and REF). If the Volts/Div is set to "Coarse", the waveform scales in a 1-2-5 step sequence from 2 mV, 5mV, 10mV...to 10 V. If the Volts/Div is set to "Fine", it scales to small steps between the coarse settings. Turn the knob clockwise to decrease the vertical scale, turn the knob counter-clockwise to increase the vertical Volts/Div setting. You can toggle between "coarse" and "Fine" setting through pressing the SCALE knob.
3. During the vertical positioning, a position message is displayed on the left bottom of the screen, such as POS:32.4mV in the same color along with the corresponding channel. The unit is V (Volts).

Channel Settings

Each channel of DS1000B series digital oscilloscope has an independent operation menu and it will pop-up after pressing any button among **CH1**, **CH2**, **CH3**, **CH4**. The menu to set CH1 is shown in the table below. Press **CH1** to enter the following menus.

Figure 2-1 Table 2-2 Channel menu (Page 1/2)





Menu	Settings	Comments
Coupling	AC	Block DC component of the input Signal.
	DC	Pass both AC and DC components of the input signal
	GND	Disconnect the input signal.
BW Limit	ON	Limit the channel's bandwidth to 20MHz to reduce display noise.
	OFF	Get full bandwidth.
Probe	0.001X ... 1000X	Set up the probe attenuation factor by 1-2-5 to make the vertical scale readout correct. including: 0.001X,0.01X,0.1X,1X,2X,5X,10X,20 X,50X,100X,200X,500X,1000X
Digital Filter		Set up digital filter (See table 2-5).
	1/2	Go to the next menu page (The followings are the same, no more explanation).

Figure 2-2 Table 2-3 Channel menu (Page 2/2)



Menu	Settings	Comments
	2/2	Back to the previous menu page (The followings are the same, no more explanation).
Volts/Div	Coarse Fine	Define a 1-2-5 sequence. To change the Volts/Div settings in small steps between the coarse settings.
Invert	ON OFF	Turn on the invert function. Restore to original display of the waveform.
Unit	V/ A/ W/ U	Set "V", "A", "W" or "U" as the unit of vertical channel.

1. To set up channel coupling

To use Channel 1 as an example, input a square wave signal with DC shift. Press **[CH1]** → **Coupling** → **DC** to set "DC" coupling. Both the AC component and the DC component of the input signal will pass.

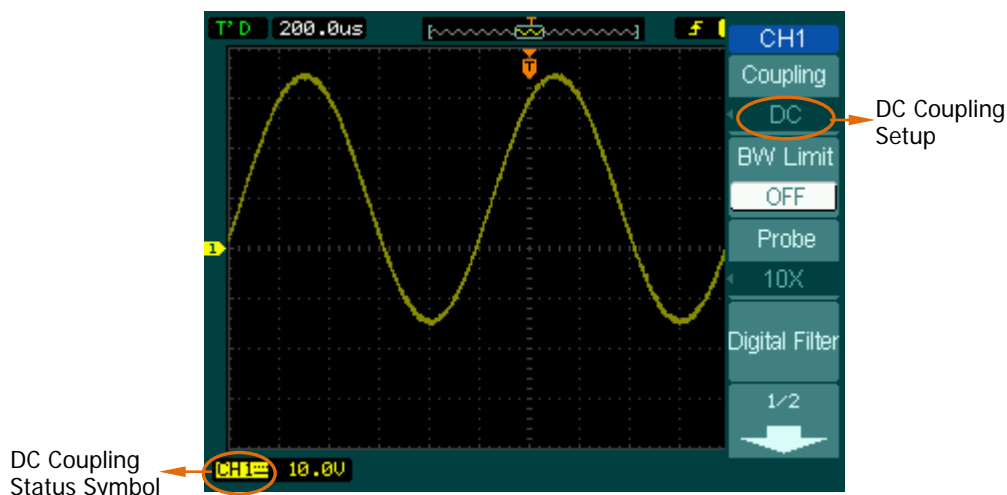

Figure 2-3 DC coupling settings

Press **[CH1]** → **Coupling** → **AC**, to set "AC" coupling. It will pass AC component of the input signal with frequency higher than 5 Hz and restraint DC component of the input signal.

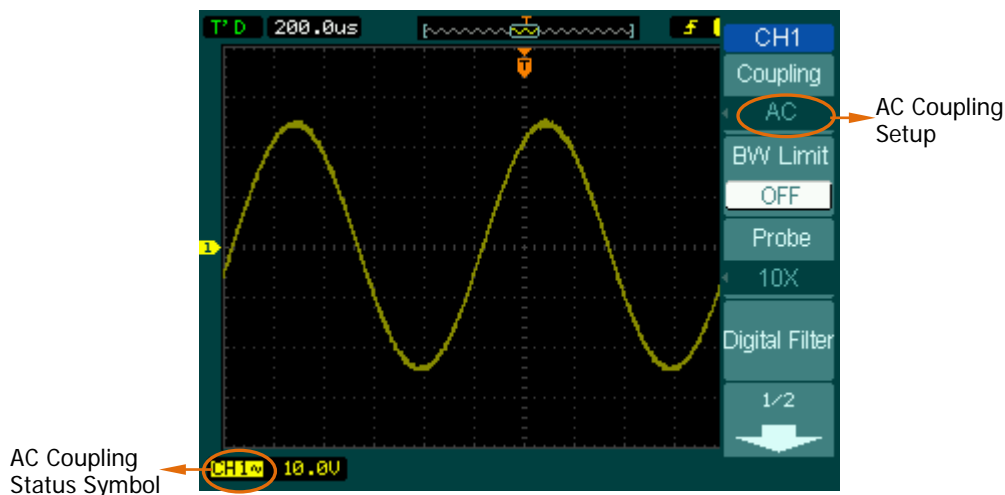

Figure 2-4 AC coupling settings

Press **CH1** → **Coupling** → **GND**, to set “GND” coupling, it disconnects the input signal. The screen displays as Figure 2-5:

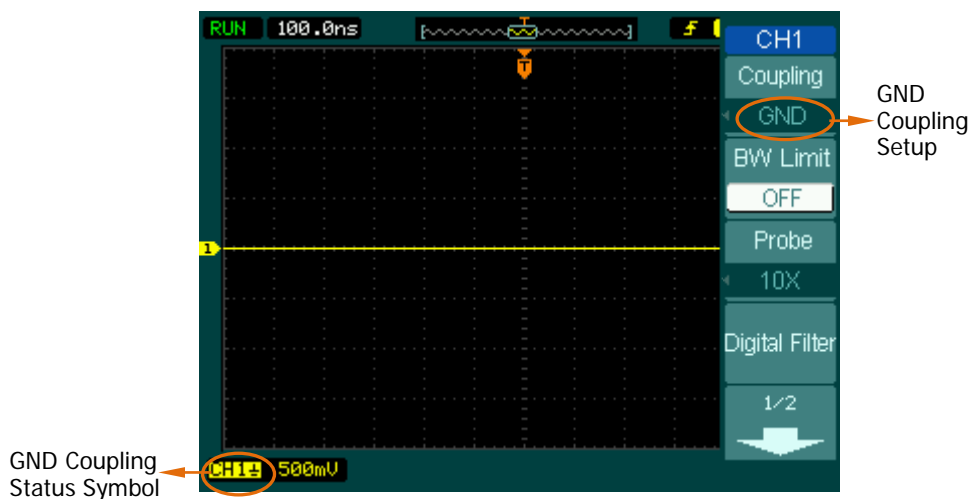

Figure 2-5 Ground coupling settings

2. To set up the channel bandwidth limit

Take Channel 1 for an example, input a signal containing high frequency component. Press **CH1**→**BW Limit**→**OFF**, to set up bandwidth limit to “OFF” status. The oscilloscope is set to full bandwidth and passing the high frequency component in the signal.

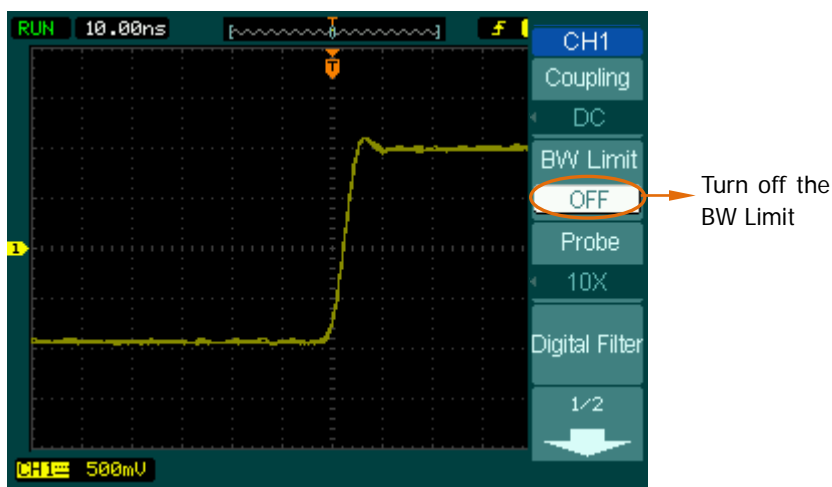

Figure 2-6 Turn off the BW limit

Press **CH1**→**BW Limit**→**ON**, to set up bandwidth limit to “ON” status. It will restraint the frequency component higher than 20MHz.

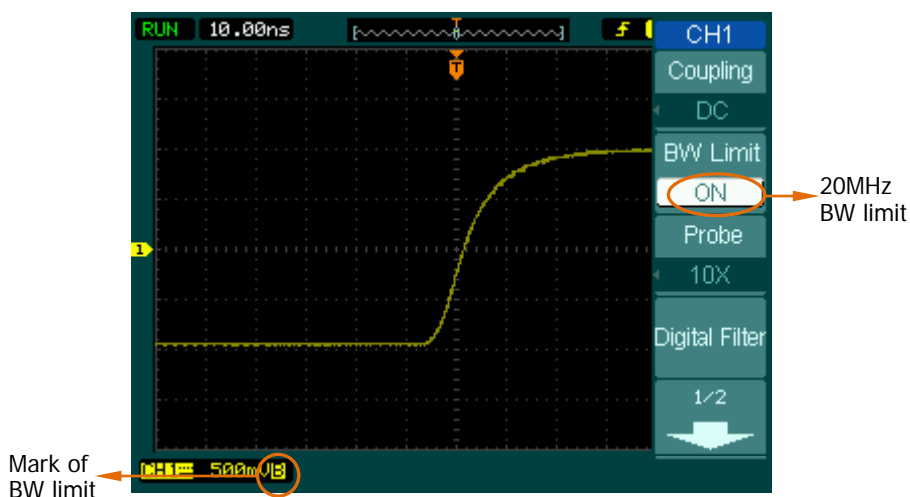
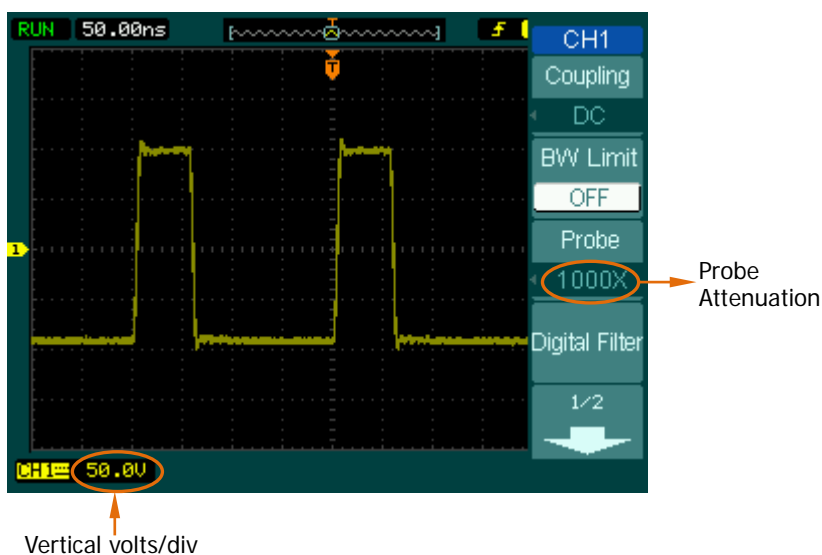

Figure 2-7 Turn on the BW limit

3. To set up Probe Attenuation

The oscilloscope allows selecting the attenuation factor for the probe. The attenuation factor changes the vertical scaling of the oscilloscope so that the measurement results reflect the actual voltage levels at the probe tip. Figure 2-8 shows an example for using a 1000:1 probe and its attenuation factor.



Vertical volts/div

Figure 2-8 Set up probe attenuation coefficient

Table 2-4 Probe setting

Probe Attenuation Factors	Corresponding Settings
1:1000	0.001X
1:100	0.01X
1:10	0.1X
1:1	1X
2:1	2X
5:1	5X
10:1	10X
20:1	20X
50:1	50X
100:1	100X
200:1	200X
500:1	500X
1000:1	1000X

4. Digital Filter

Press **CH1** → **Digital Filter** to display the digital filter menu.

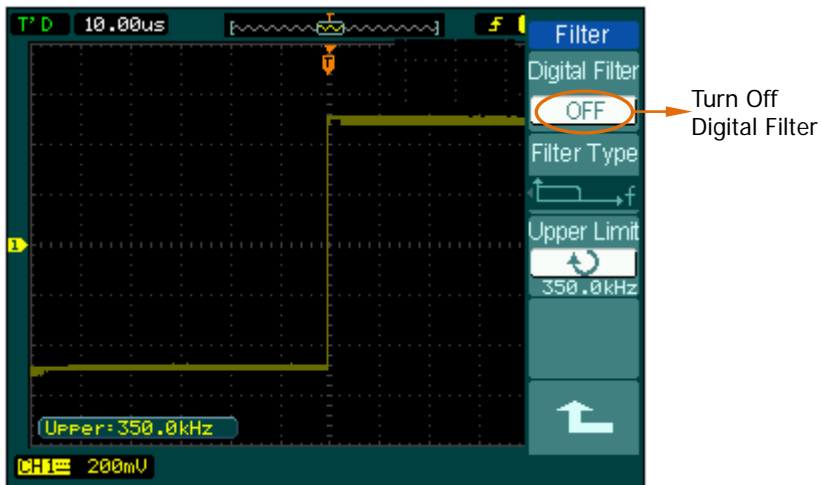

Figure 2-9 Turn off digital filter

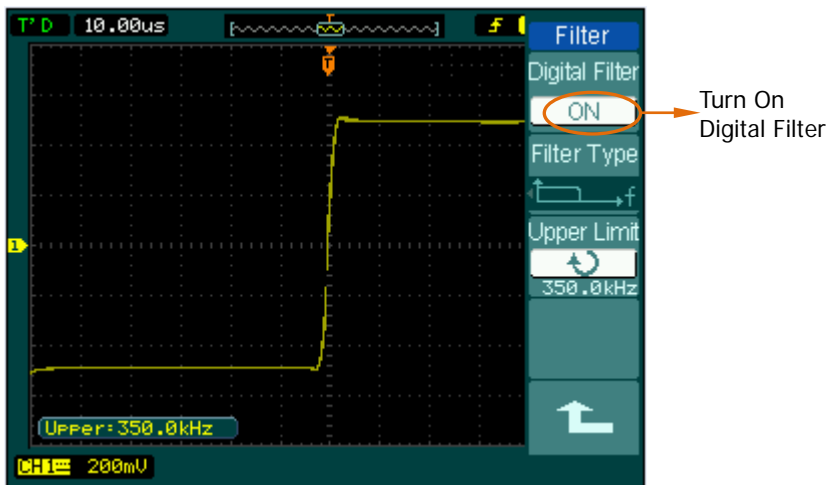
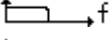
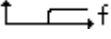
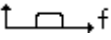
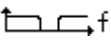







Figure 2-10 Turn on digital filter

Turn the digital filter on or off as shown in the following figure. Turn (↻) knob to adjust the upper and lower limit of frequency after turning on the digital filter.

Figure 2-11 Table 2-5 The Filter menu



Menu	Settings	Comments
Digital Filter	ON OFF	Turn on the digital filter. Turn off the digital filter.
Filter Type	 f  f  f  f	Setup as LPF (Low Pass Filter). Setup as HPF (High Pass Filter). Setup as BPF (Band Pass Filter). Setup as BRF (Band Reject Filter).
Upper Limit ^[1]	 <frequency>	Turn () knob to set upper limit high limit.
Lower Limit ^[1]	 <frequency>	Turn () knob to set lower limit.
		Back to higher level menu (The followings are the same, no more explanation).

NOTE:

- [1] The upper limit needs to be set in the type of low pass filter.
The lower limit needs to be set in the type of high pass filter.
Both upper limit and lower limit need to be set in the types of band pass filter and band reject filter.

5. To change the Volts/Div settings

The **Volts/Div** control has **Coarse** or **Fine** configuration. The Vertical Sensitivity is 2mV/div - 10V/div.

Coarse: It is the default setting of Volts/Div in a 1-2-5-step sequence from 2mV/div, 5mV/div, 10mV/div, to 10 V/div.

Fine: This setting changes the vertical scale to small steps between the coarse settings. It will be helpful to adjust the waveform in smooth steps.

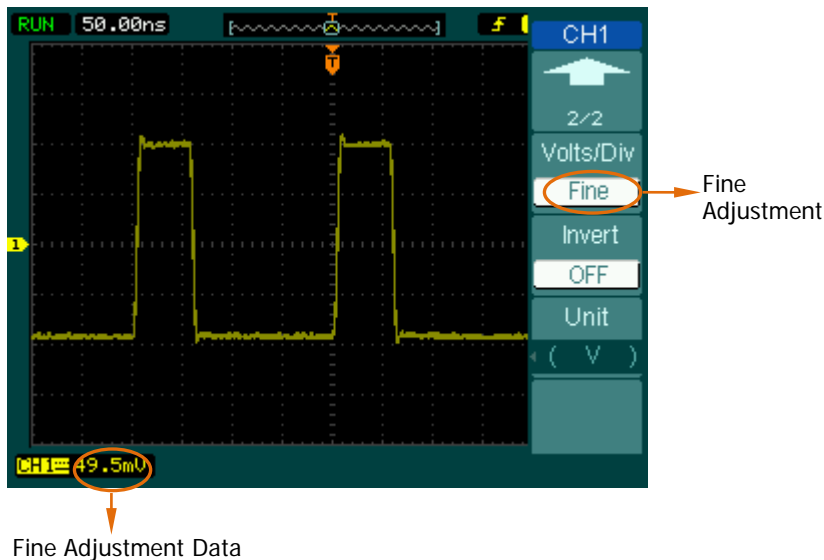

Figure 2-12 Fine Adjustment

Coarse/Fine Shortcut key

To change Coarse/Fine setting, not only by menu but also by pressing vertical **SCALE** knob.

6. To invert a waveform

Invert turns the displayed waveform 180 degrees with respect to the ground level. When the oscilloscope is triggered on the inverted signal, the trigger is also inverted. Figure 2-13 and Figure 2-14 show the changes before and after the inversion respectively.

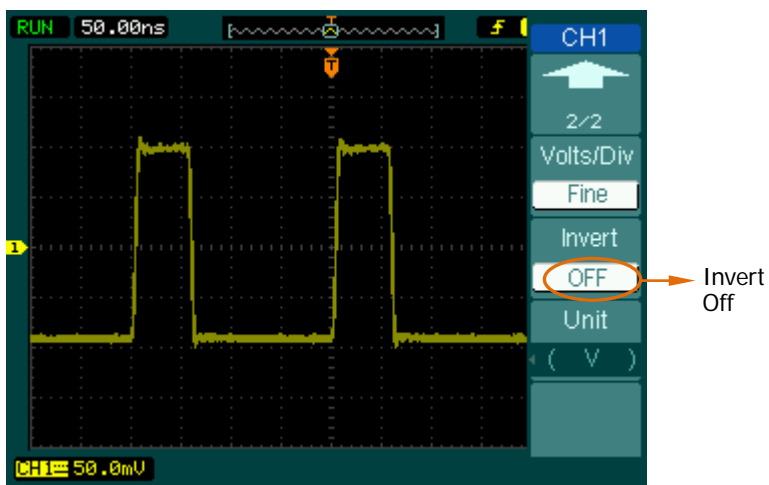

Figure 2-13 Waveform before inversion

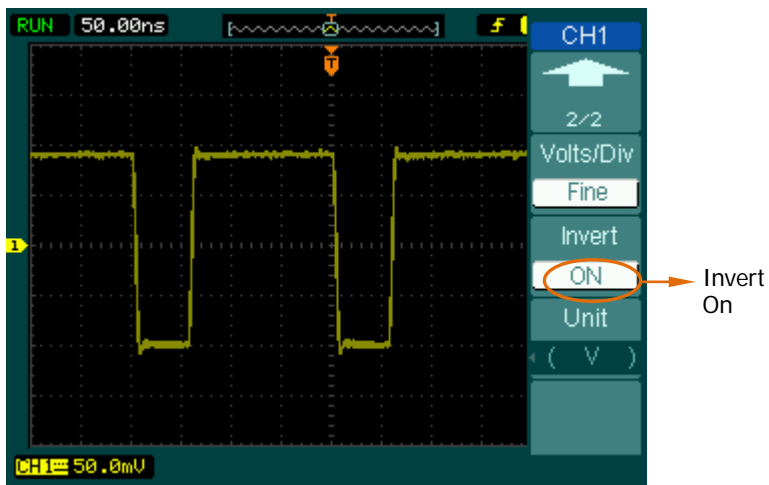

Figure 2-14 Waveform after inversion

Math Function

The mathematic functions include “add”, “subtract”, “Multiply” and “FFT” for CH1, CH2, CH3 and CH4. The mathematic result can be measured by the grid and the cursor.

Press **MATH** button to enter “Math” menu, meanwhile, sign of math scale will appear under the screen. See figure below, waveform of CH1 is marked yellow, waveform of CH2 is marked blue, and waveform of CH1 adding CH2 is marked purple.

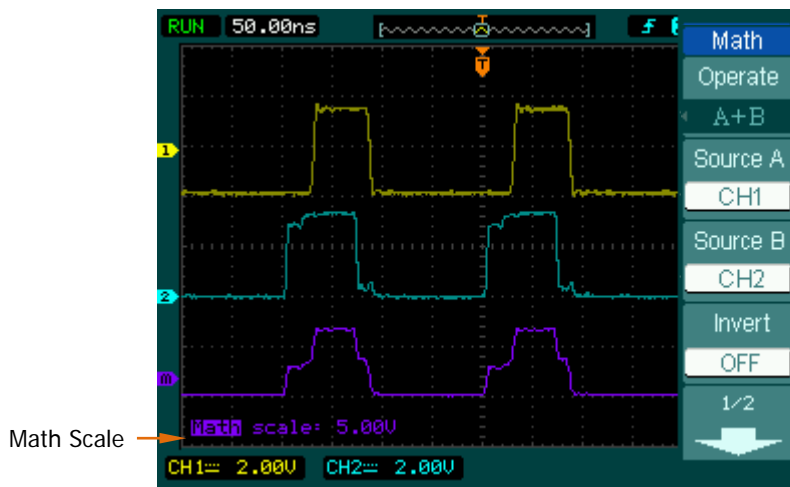
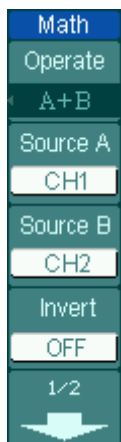

Figure 2-15 Math function







Figure 2-16 Table 2-6 The Math menu (Page 1/2)



Menu	Settings	Comments
Operate	A+B	Add source A and source B.
	A-B	Subtract source B from source A.
	AxB	Multiply source B by source A.
	FFT	Fast Fourier Transform.
Source A	CH1, CH2, CH3, CH4	Define CH1, CH2, CH3 or CH4 as source A.
Source B	CH1, CH2, CH3, CH4	Define CH1, CH2, CH3 or CH4 as source B.
Invert	ON	Invert the MATH waveform.
	OFF	Restore to original waveform display.

Figure 2-17 Table 2-7 The Math menu (Page 2/2)



Menu	Settings	Comments
 .. 		The multifunctional knob () adjusts the vertical position of the Math waveform.
 ~ 		The multifunctional knob () adjusts the vertical amplitude of the Math waveform.
Reset		Reset the math waveform to vertical mid-point.

1. Using FFT function

The FFT (Fast Fourier Transform) process converts a time-domain signal into its frequency components mathematically. FFT waveforms are useful in the following applications:

- Measuring harmonic content and distortion in systems
- Characterizing noise in DC power supplies
- Analyzing vibration

Press **MATH** → **Operate** → **FFT** to enter FFT setting menu.

Figure 2-18 Table 2-8 The FFT menu (Page 1/2)



Menu	Settings	Comments
Operate	A+B	Add source A to source B.
	A-B	Subtract source B from source A.
	A×B	Multiply source B by source A.
	FFT	Fast Fourier Transform.
Source	CH1, CH2, CH3, CH4	Define CH1, CH2, CH3 or CH4 as FFT source.
Window	Rectangle Hanning Hamming Blackman	Select window for FFT.
Display	Split Full screen	Display FFT waveform on half screen. Display FFT waveform on full screen.

Figure 2-19 Table 2-9 The FFT menu (Page 2/2)



Menu	Settings	comments
		The multifunctional knob () adjusts the vertical position of Math
		The multifunctional knob () adjusts the vertical amplitude of Math
Scale	V_{RMS} dBV_{RMS}	Set V_{RMS} as vertical scale unit Set dBV_{RMS} as vertical scale unit
Reset		Reset the math waveform to vertical mid-point.

Key points for FFT

1. Signals that have a DC component or offset can cause incorrect FFT waveform component magnitude values. To minimize the DC component, choose AC Coupling on the source signal.
2. To reduce random noise and aliases components in repetitive or single-shot events, set the oscilloscope acquisition mode to Average.
3. To display FFT waveforms with a large dynamic range, use the dBV_{RMS} scale. The dBV_{RMS} scale displays component magnitudes using a log scale.

2. Selecting an FFT Window

DS1000B series oscilloscope provides four FFT windows. Each window is a trade-off between frequency resolution and amplitude accuracy. It depends on the desired measurement and the source signals characteristics to determine the window to use. Use the following guidelines to select the best window.

DS1000B provides four FFT functions with different features, which are needed to be selected according to measuring waveform.

Table 2-10 FFT Windows

Window	Features	Best for measuring
Rectangle	Best frequency resolution and worst amplitude accuracy. This is essentially the same as no window.	Transients or bursts, the signal levels before and after the event are nearly equal. Equal-amplitude sine waves with fixed frequencies. Broadband random noise with a relatively slow varying spectrum.
Hanning	Better frequency resolution, poorer amplitude accuracy than Rectangular.	Sine, periodic, and narrow-band random noise.
Hamming	Hamming has slightly better frequency resolution than Hanning.	Transients or bursts where the signal levels before and after the events are significantly different.
Blackman	Best amplitude accuracy, worst frequency resolution.	Single frequency waveforms, to find higher order harmonics.

Term Explanations

FFT Resolution: The FFT resolution is the quotient between sampling rate and the number of FFT points. With a fixed FFT points, the lower sampling rate, the better the resolution.

Nyquist Frequency: The highest frequency that any real-time digitizing oscilloscope can acquire without aliasing. It's normally half of the sample rate. This frequency is called the Nyquist frequency. Frequency above the Nyquist frequency will be under sampled, causing a situation known as aliasing.

REF Function

Reference Waveforms are saved waveforms to be selected for display. The reference function will be available after saving the selected waveform to non-volatile memory. During the actual measurement process, you can use DS1000B series digital oscilloscope to observe the waveforms of correlative components. It will help you to determine the cause of malfunction when you compare the measured waveform with the reference waveform. The method is particularly useful under the circumstance of having reference waveforms.

Press **REF** button to display the Reference waveform menu.

Figure 2-20 Table 2-11 REF menu when using internal memory (Page 1/3)



Menu	Settings	Comments
Channel	REF 1 REF 2 REF 3 REF 4	Turn on or turn off one to four REF channels
Current	REF 1 REF 2 REF 3 REF 4	Select the current REF channel which is optional from REF1 to REF4. (According to the available channel, for example, if only REF1 is turned on, then only REF1 can be chosen as the current channel.)
Source	CH1 CH2 CH3 CH4 MATH	Select CH1, CH2, CH3, CH4, and MATH as the source channel whose input waveforms will be compared with the reference waveforms.
location	Internal external	Select memory location in scope. Select memory location out scope.

Figure 2-21 Table 2-12 REF menu when using internal/external memory (Page 2/3)



Menu	Settings	Comments
Save		Save REF waveform to outer memory location.
		The multifunctional knob (⌚) adjusts the vertical position of REF
		The multifunctional knob (⌚) adjusts the vertical amplitude of REF

Figure 2-22 Table 2-13 REF menu when using internal memory (Page 3/3)



Menu	settings	comments
Reset		Reset REF waveform.
Imp./Exp.		Go to import menu (see table 2-19).

Figure 2-23 Table 2-14 REF menu when using external memory (Page 3/3)



Menu	settings	comments
Reset		Reset REF waveform.
Import		Go to import menu (see table 2-19).

1. Import and Export

Switch to external memory and select **Internal** location.

Then, press **REF** → **Imp. /Exp.** and enter the following interface.



Figure 2-24 Import and export interface

Figure 2-25 Table 2-15 Imp. /Exp. Menu



Menu	Settings	Comments
Explorer	Path Directory File	Switch to Path, directory or file.
Export		Export the REF file from internal memory to external memory (see table 2-16).
Import		Import the REF file to internal memory.
Delete File		Delete file.

2. Export

Switch to external memory and select Internal location.

Then, press REF → Imp. /Exp. → Export and go to the following interface.



Figure 2-26 Export interface

Figure 2-27 Table 2-16 The Export menu



Menu	Settings	Comments
↑ ↓		Move the input focus point of files' name up and down.
↻		Move the focus point to next location.
✕		To delete chosen letter.
Save		Execute the operation.

3. Save to External Memory

Switch to external memory and select External location.
 Then, press **REF** → **Save** and enter the following interface.

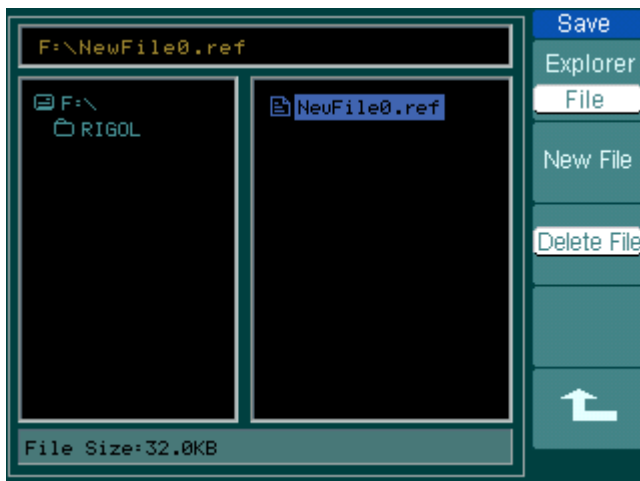

Figure 2-28 Save interface

Figure 2-29 Table 2-17 The Save menu



Menu	Settings	Comments
Explorer	Path Directories Files	Switch among Path, Directories and Files.
New File (Folder)		Set up new file in Path and File. Set up new folder in directory.
Delete File (Folder)		Delete chosen file (Folder).

4. New File (or New Folder)

Switch to external memory and select External location.

Then, press **REF**→**Save**→**New File** (or **New Folder**) and go to the following interface.

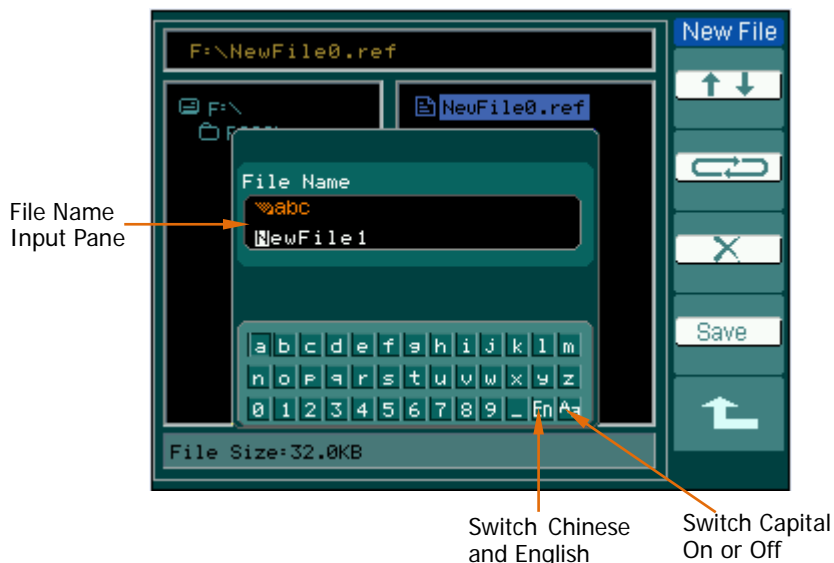

Figure 2-30

File name in English inputting interface

Figure 2-31 Table 2-18 The New File menu



Menu	Settings	Comments
↑ ↓		Move the focus point of file name up and down.
↻		Move the focus point to the next location.
✕		To delete chosen letter.
Save		Execute the saving operation.

5. Import

Switch to external memory and select External location.
 Then, press **REF** → **Import** and enter the following interface.

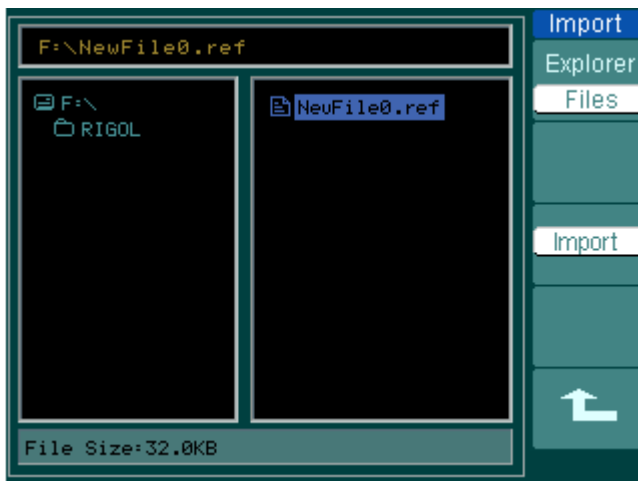

Figure 2-32 Import interface

Figure 2-33 Table 2-19 The Import menu



Menu	Settings	Comments
Explorer	Path Directories Files	Switch among Path, Directories and Files.
Import		Import the REF file into internal memory.

6. Display a Reference Waveform

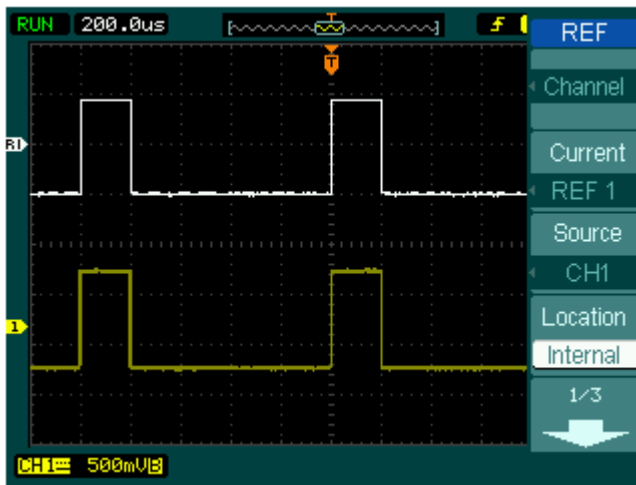

Figure 2-34
Reference waveform display

Operation introductions:

1. Press **REF** button to show the reference waveform menu.
2. Press soft button 3 to select the reference channel: **CH1**, **CH2**, **CH3**, **CH4** or **MATH**.
3. Turn vertical **POSITION** and vertical **SCALE** to adjust the REF waveform to a suitable position.
4. Press soft button No.4 to select the save location of REF waveform.
5. Enter to REF menu (Page2/3) Press soft button No.2 to save the waveform as REF.

NOTE: The Reference function is not available in X-Y mode.

To Set up the Horizontal System

Press **MENU** button to enter the horizontal setting system.

Figure 2-35 Table 2-20 The Horizontal menu



Menu	Settings	Comments
Delayed	ON OFF	Turn on the Delayed Scan mode. Turn off the Delayed Scan mode.
TimeExpand	ScreenCenter Trigger User	The waveform expands or compresses horizontally around the center of the screen when the horizontal time base is changed. The waveform expands or compresses horizontally around the trigger point when the horizontal time base is changed. The waveform expands or compresses horizontally around the user-defined reference position when the horizontal time base is changed.
Time Base	Y-T X-Y Roll ^[1]	Show the relative relation between vertical voltage and horizontal time. Show CH1 amplitude value at X axis; show CH2 amplitude value at Y axis. In Roll Mode, the waveform display updates from right to left.
Trig-Offset	Reset	Adjust the trigger position to the center of the memory.

NOTE:



[1] In Roll mode, both the horizontal **POSITION** knob and trigger control are inoperative. Once the oscilloscope is set to Roll mode, the time base should be 50ms or slower.

Term Explanations

Slow Scan Mode: This mode is available when the horizontal time base is set to 50ms or slower. In this mode, the oscilloscope acquires sufficient data for the left part to the trigger point, then wait for trigger, when trigger occurs, it continue to draw the rest part from the trigger point to the end of the right side. When choosing this mode to view low frequency signals, it is recommended that the channel coupling be set as DC.

Knobs Explanation

The horizontal controls change the horizontal scale and position of waveforms. The horizontal center of the screen is the time reference for waveforms. Changing the horizontal scale causes the waveform to be expanded or compressed with respect to the screen center. Horizontal position changes the displayed waveform position, relative to the trigger point.

1. The horizontal  **POSITION** knob adjusts the horizontal position of all channels (including Math) waveforms. The resolution of this control varies with the time base. Pressing this button clears the trigger offset and moves the trigger point to the horizontal center of the screen.
2. Use  **SCALE** to select the horizontal time/div (scale factor) for the main or the Delayed scan time base. When Delayed Scan is enabled, it changes the width of the window zone by changing the Delayed Scan time base.

Delayed Scan

The Delayed Scan is a magnified portion of the main waveform window. Use Delayed Scan to locate and horizontally expand part of the main waveform window for a more detailed (higher horizontal resolution) analysis of signal. The Delayed Scan time base setting cannot be set slower than the Main time base setting.

Press **MENU** → Delayed → ON, or press horizontal **SCALE** knob to turn on delayed scan function. See the waveform below.

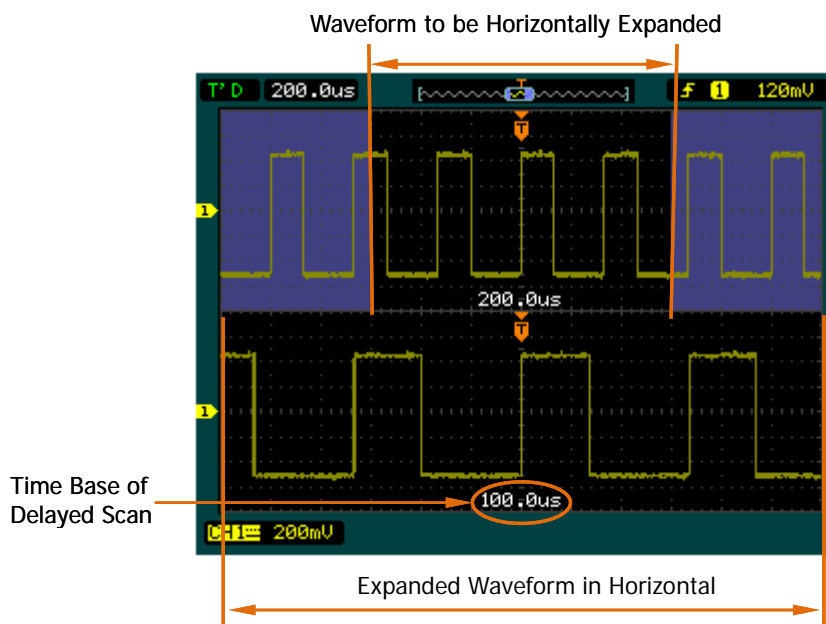

Figure 2-36 Delayed scan windows

The screen will be split into two parts.

The upper half displays the main waveform window and the lower half displays an expanded portion of the main waveform window. This expanded portion of the main window is called the Delayed Scan window. Two blocks shaded at the upper half; the un-shaded portion is expanded in the lower half. The horizontal **POSITION** and **SCALE** knobs control the size and position of the Delayed Scan. The value at top of the screen is the main time base and the value on the center bottom means the Delayed Scan time base.

X-Y Format

This format is useful for studying phase relationships between CH1 and CH2 (CH3 and CH4 can't be used). CH1 in the horizontal axis(X) and CH2 in the vertical axis(Y), the oscilloscope uses a none-trigger acquisition mode, data is displayed as dots.

Press **MENU** → Time Base → X-Y to enter X-Y mode.

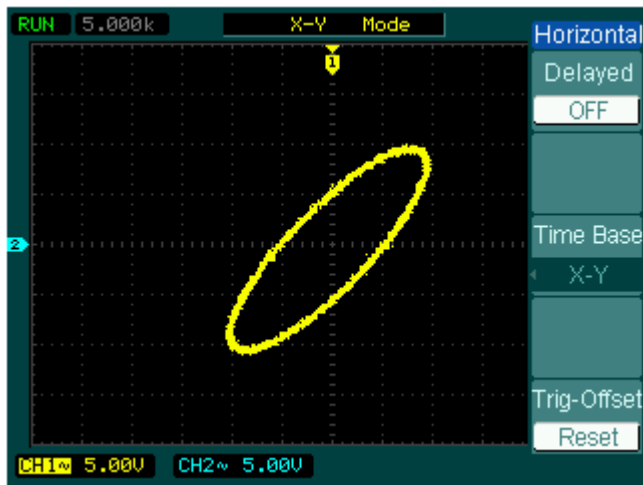

Figure 2-37 X-Y display format

The oscilloscope can acquire waveforms with any sampling rate in Y-T mode (up to 2GSa/s for single channel or half channel ^[1]). But in X-Y mode, up to 1GSa/s can be used and the default is 250MSa/s. Generally, the lower the sample rate is, the better the Lissajous graphic will be.

NOTE [1]: Half channel indicates selecting one of the channels in CH1 and CH2, or in CH3 and CH4.

The following modes or functions will not work in X-Y format.

- Cursor measurement (Track and Auto modes)
- Pass/Fail Function
- REF and MATH Operations
- Delayed Scan Mode
- Vector Display Mode
- Horizontal **POSITION** knob
- Trigger Controls

To Set up the Trigger System

The trigger determines when the oscilloscope starts to acquire data and display a waveform. When a trigger is set up properly, it can convert unstable displays or blank screens into meaningful waveforms.

When the oscilloscope starts to acquire a waveform, it collects enough data so that it can draw the waveform to the left of the trigger point. The oscilloscope continues to acquire data while waiting for the trigger condition to occur. After it detects a trigger, the oscilloscope continues to acquire enough data so that it can draw the waveform to the right of the trigger point.

Press **MENU** button to enter trigger system setting interface.

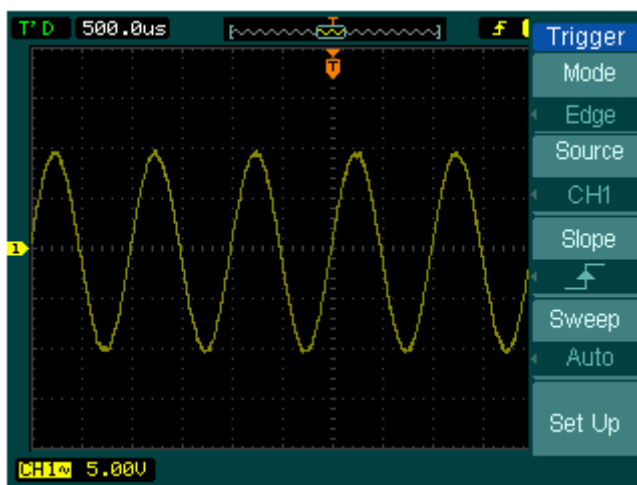

Figure 2-38 Trigger system interface

DS1000B provides five trigger modes: Edge, Pulse, Video, Pattern and Alternative.

Edge: An edge trigger occurs when the trigger input passes through a specified voltage level in the specified slope direction.

Pulse: Use this trigger mode to catch pulses with certain pulse width.

Video: Use video trigger mode on fields or lines for standard video signals.

Pattern: Recognising trigger by searching specified code.

Alternative: Trigger on non-synchronized signals.

Edge Trigger

An edge trigger determines whether the oscilloscope finds the trigger point on the rising or the falling edge of a signal. Select Edge trigger Mode to trigger on Rising edge, falling edge or rising & falling edge.

Press **MENU** → **Mode** → **Edge** to enter the following menu.

Figure 2-39 Table 2-21 The Trigger menu



Menu	Settings	Comments
Source	CH1	Select CH1 as trigger source.
	CH2	Select CH2 as trigger source.
	CH3	Select CH3 as trigger source.
	CH4	Select CH4 as trigger source.
	EXT	Select EXT TRIG as trigger source.
Slope	EXT/5	Select attenuated EXT TRIG/5 as trigger source.
	AC Line	Select power line as trigger source.
Slope	↗	Trigger on rising edge.
	↘	Trigger on falling edge.
	↕	Trigger on both ring & falling edge.
Sweep	Auto	Acquire waveform even no trigger occurred.
	Normal	Acquire waveform when trigger occurred.
	Single	When trigger occurs, acquire one waveform then stop.
Set up		To go to Set Up menu, see table 2-34

Pulse Width Trigger

Pulse trigger occurs according to the width of pulse. The abnormal signals can be detected through setting up the pulse width condition. Press **MENU**→**Mode**→**Pulse** to enter the following menu.

Figure 2-40 Table 2-22 The Trigger menu (Page 1/2)











Menu	Settings	Comments
Source	CH1 CH2 CH3 CH4 EXT EXT/5	Select CH1 as trigger source. Select CH2 as trigger source. Select CH3 as trigger source Select CH4 as trigger source I Select EXT TRIG as trigger source Select attenuated EXT TRIG/5 as trigger source.
When	     	Set Pulse width as "+pulse width less than" Set Pulse width as "+pulse width more than" Set Pulse width as "+pulse width equal to" Set Pulse width as "-pulse width less than" Set Pulse width as "-pulse width more than" Set Pulse width as "-pulse width equal to"
Settings	 <Width>	To set required pulse width.

Figure 2-41 Table 2-23 The Trigger menu (Page 2/2)



Menu	Settings	Comments
Sweep	Auto Normal Single	Acquire waveform even no trigger occurred. Acquire waveform when trigger occurred. When trigger occurs, acquire one waveform and then stop.
Set Up		To go to Set Up menu, see table 2-34.

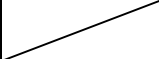

NOTE: The Pulse width adjust range is 20ns~10s. When the condition is met, it will trigger and acquire the waveform.

Video Trigger

Choose video trigger to trigger on fields or lines of NTSC, PAL, or SECAM standard video signals. Trigger coupling preset to DC. Press **MENU** → **Mode** → **Video** to enter the following menu.

Figure 2-42 Table 2-24 The Video Trigger menu (Page 1/2)



Menu	Settings	Comments
Source	CH1	Selects CH1 as trigger source.
	CH2	Selects CH2 as trigger source.
	CH3	Selects CH3 as trigger source.
	CH4	Selects CH4 as trigger source.
	EXT	Select EXT TRIG as trigger source.
	EXT/5	Select EXT TRIG/5 as trigger source.
Polarity *	 Normal polarity	Trigger on the negative edge of the sync pulse
	 Inverted polarity	Trigger on the positive edge of the sync pulse
Sync	All Lines	Trigger on all lines.
	Line Num	Trigger on a specified line.
	Odd field	Select to trigger on odd field.
	Even field	Select to trigger on even field.

Note*: **normal polarity** is applicable to signal with negative horizontal sync pulse; **inverted polarity** is applicable to signal with positive horizontal sync pulse.

Figure 2-43 Table 2-25 The Video Trigger menu (Line Num, Page 2/2)



Menu	Settings	Comments
Line Num	 < Line sync >	The range is from No.1 to No.525 when NTSC video standard is used and from No.1 to No.625 when PAL/SECAM video standard is used.
Standard	PAL/SECAM NTSC	Select Video standard.
Sweep	Auto Normal Single	Acquire waveform even no trigger occurred. Acquire waveform when trigger occurred. When trigger occurs, acquire one waveform and then stop.
Set Up		To go to set up menu, see Table 2-36.

Figure 2-44 Table 2-26 The Video Trigger menu (All lines, Odd field and Even field, Page2/2)



Menu	Settings	Comments
Standard	PAL/SECAM NTSC	Select Video standard.
Sweep	Auto Normal Single	Acquire waveform even no trigger occurred. Acquire waveform when trigger occurred. When trigger occurs, acquire one waveform and then stop.
Set Up		To go to set up menu, see Table 2-36.

Select "Line Synchronization":

Select "Filed Synchronization":

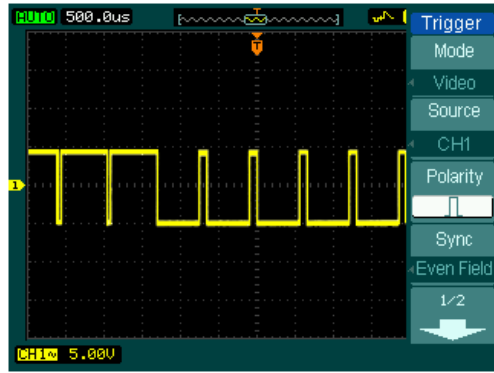
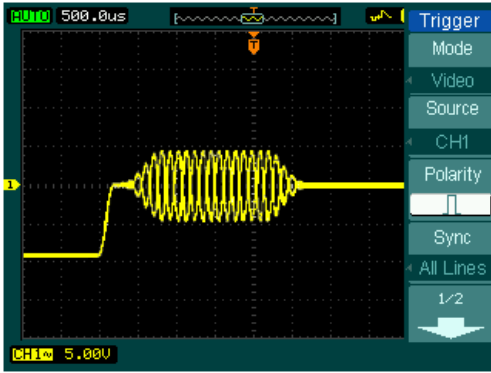

Figure 2-45

Figure 2-46

Video Trigger: Line Synchronization

Video Trigger: Field Synchronization

Pattern Trigger

Pattern trigger recognises the trigger condition through inspecting the code preset which means the logic values or the logic combination. Every channel has its own logic value, such as, logic high value, logic low value, and the neglect value. Press **MENU** → **Mode** → **Pattern** to enter the following menu.

Figure 2-47 Table 2-27 The Pattern Trigger menu

Trigger	Menu	Settings	Comments
Mode	Channel	CH1	To select CH1 as trigger source
Pattern		CH2	To select CH2 as trigger source
Channel		CH3	To select CH3 as trigger source
CH1		CH4	To select CH4 as trigger source
Code		EXT	To set EXT as trigger source
X		EXT/5	To set EXT/5 as trigger source to expand trigger level range.
Sweep	Code	H	To set the code of the selected channel as logic high value.
Auto		L	To set the code of the selected channel as logic low value.
Set Up		X	To set the code of the selected channel as neglect value.
		↕	To specify trigger to the rising edge of signal
		↘	To specify trigger to the falling edge of signal
	Sweep	Auto	Acquire waveform even no trigger occurred.
		Normal Single	Acquire waveform when trigger occurred. When trigger occurs, acquire one waveform then stop.
	Set up		To go to set up menu, see Table 2-34.

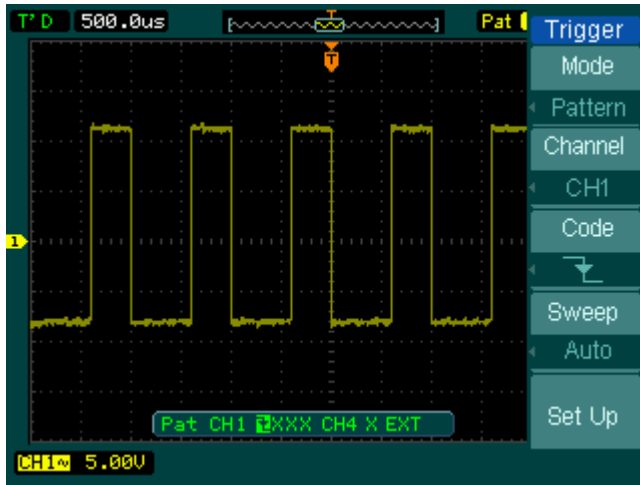



Figure 2-48
Pattern trigger: set code as falling edge

Alternative Trigger

When alternative trigger is on, the trigger sources come from two vertical channels. This mode can be used to observe two non-related signals. You can choose two different trigger modes for the two vertical channels. The options are as follows: Edge, Pulse and video. The info of the trigger level of the two channels will be displayed on the upper-right of the screen. Press **MENU** → **Mode** → **Alternative** to enter the following menu.

Figure 2-49 Table 2-28 The Alternative trigger menu (Page 1/2 Trigger Type: Edge)



Menu	Settings	Comments
Alt Channel	CH1-CH2 CH1-CH3 CH1-CH4 CH2-CH3 CH2-CH4 CH3-CH4	To specify the current alternative trigger channels as any two channels selected form CH1, CH2, CH3, CH4.
select	CH1, CH2 CH3, CH4	To select vertical channel among CH1, CH2, CH3, CH4 in alternative trigger mode so as to configure further settings.
Type	Edge Pulse Video	Choose trigger type for the current channel.

Figure 2-50 Table 2-29 The Alternative trigger menu (Page 2/2 Trigger Type: Edge)



Menu	settings	comments
Edge type	↕ ↕	Trigger on rising edge. Trigger on falling edge.
Set up		To go to set up menu. See Table 2-34

Figure 2-51 Table 2-30 The Alternative trigger menu (Page 1/2 Trigger Type: Pulse)



Menu	Settings	Comments
Alt Channel	CH1-CH2 CH1-CH3 CH1-CH4 CH2-CH3 CH2-CH4 CH3-CH4	To specify the current alternative trigger channels as any two channels selected from CH1, CH2, CH3, CH4.
select	CH1, CH2, CH3, CH4	To select vertical channel among CH1, CH2, CH3, CH4 in alternative trigger mode so as to configure further settings.
type	Edge trigger Pulse trigger Video trigger	Select trigger type for current channel.

Figure 2-52 Table 2-31 The Alternative trigger menu (Page 2/2 Trigger Type: Pulse)













Menu	Settings	Comments
When	     	Set Pulse width as "+pulse width less than" Set Pulse width as "+pulse width more than" Set Pulse width as "+pulse width equal to" Set Pulse width as "-pulse width less than" Set Pulse width as "-pulse width more than" Set Pulse width as "-pulse width equal to"
Settings	 <Pulse width >	To set up width value of the pulse.
Set Up		To go to set up menu. See Table 2-34.

Figure 2-53 Table 2-32 The Alternative trigger menu (Page 1/2 Trigger Type: Video)

Menu	Settings	Comments
Alt Channel	CH1-CH2 CH1-CH3 CH1-CH4 CH2-CH3 CH2-CH4 CH3-CH4	To specify the current alternative trigger channels as any two channels selected from CH1, CH2, CH3, CH4.
select	CH1, CH2, CH3, CH4	To select vertical channel among CH1, CH2, CH3, CH4 in alternative trigger mode so as to configure further settings.
Type	Edge trigger Pulse trigger Video trigger	To select trigger type for current channel.

Figure 2-54 Table 2-33 The Alternative trigger menu (Page 2/2 Trigger Mode: Video)

Menu	Settings	Comments
Polarity*	 Normal polarity  Inverted polarity	Trigger on the negative edge of the sync pulse Trigger on the positive edge of the sync pulse
Sync	ALL lines Line Num Odd field Even field	Trigger on all lines. Trigger on a specified line. Select to trigger on odd field. Select to trigger on even field.
Standard	PAL/SECM NTSC	Select Video standard.
Set Up		To go to set up menu, see Table 2-36.

Note*: normal polarity is applicable to signal with negative horizontal sync pulse;
 inverted polarity is applicable to signal with positive horizontal sync pulse.

Trigger Settings

Set up different trigger settings according to different trigger modes. In Edge, Pulse and Pattern trigger modes. You need to set up coupling, sensitivity and trigger holdoff; in video trigger mode, to set up sensitivity and holdoff; in alternate trigger, different trigger types have different setting options.

Figure 2-55 Table 2-34 The Trigger Set Up menu
(Page 1/2 Settings for Edge, Pulse and Pattern Triggers)





Menu	Settings	Comments
Coupling	DC AC LF Reject	Allow all signals pass. Block DC signals. Reject DC and low frequency signals.
HF reject	ON off	Passes high frequency component. Blocks high frequency component, passes low frequency component.
Sensitivity	 <Sensitivity Setting>	Set trigger sensitivity between 0.1div to 1.00div.
Holdoff	 <Holdoff Setting>	Set time slot before another trigger event between 100ns to 1.5s.

Figure 2-56 Table 2-35 Page 2/2 Settings for Edge, Pulse and Pattern Triggers



Menu	Settings	comments
Holdoff	Reset	Reset Holdoff time to 500ns.

Figure 2-57 Table 2-36 Settings for Video Trigger



Menu	Settings	Comments
Sensitivity	<Sensitivity Setting>	Set trigger sensitivity between 0.1div to 1.00div.
Holdoff	<Holdoff Setting>	Set time slot before another trigger event between 100ns to 1.5s.
Holdoff	Reset	Reset Holdoff time to 500ns.

Trigger Holdoff

You can use trigger Holdoff to stabilize a complex waveform, such as a pulse sequence. Holdoff time is the oscilloscope's waiting period before starting a new trigger. During Holdoff, oscilloscope will not trigger until Holdoff ends. For instance: To trigger on the first pulse on a group of them, users can set the holdoff time to Pulse cluster width.

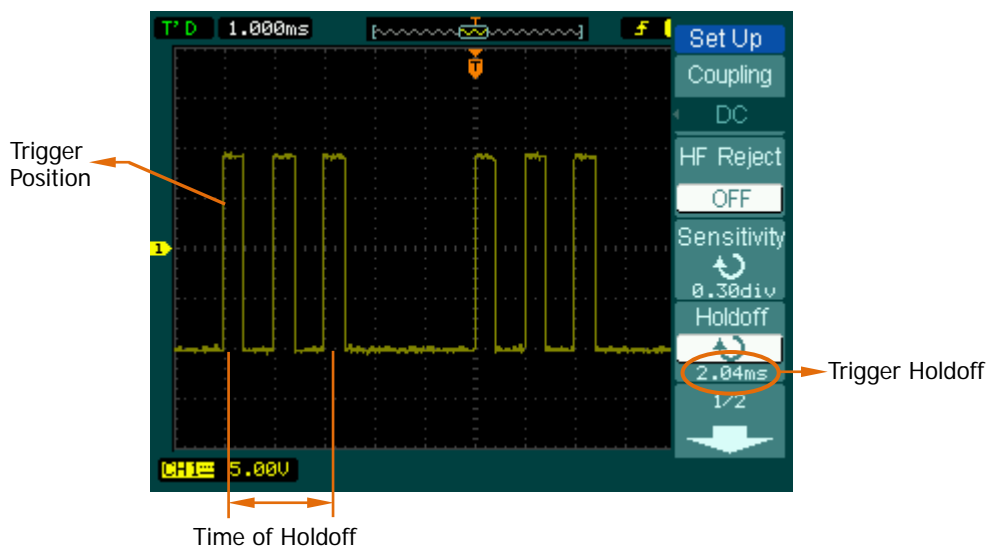

Figure 2-58 Trigger holdoff

Operation Explanations:

1. Press the **MENU** button of the trigger control system to display the Menu.
2. Press **Set Up** key to display trigger set up menu.
3. Turn the multi function knob (⌚) to change Holdoff time until waveform is stable.
4. Press Trigger **Holdoff** → **Reset** to reset the Holdoff time to its default value (500ns).

Trigger Terms Explanation

1. Trigger Source:

Trigger occurs from several sources: Input channels (CH1, CH2, CH3, CH4), AC Line, Ext, Ext/5.

- **CH1, CH2, CH3, CH4:**

It is the most commonly used trigger source. The channel works when it is selected as a trigger source whatever displayed.

- **Ext Trig:**

The instrument can be triggered from an external source while acquiring data from CH1, CH2, CH3, and CH4. For example, be a trigger source with an external clock or a signal from another part of the test circuit. The Ext, Ext/5 trigger sources use an external trigger signal connected to the EXT TRIG connector. Ext uses the signal directly; it has a trigger level range of -0.6 V to +0.6 V. The EXT/5 trigger source attenuates the signal by 5X, which extends the trigger level range to -3V to +3 V allowing the oscilloscope to trigger on a larger signal.

- **AC Line:**

AC power can be used to display signals related to the power line frequency, such as lighting equipment and power supply devices. The oscilloscope gets triggered on its AC power input, but an AC trigger signal is not required.

2. Trigger Mode:

The trigger mode determines how the oscilloscope behaves in the absence of a trigger event. The oscilloscope provides three trigger modes: Auto, Normal, and Single.

- **Auto:**

This sweep mode allows the oscilloscope to acquire waveforms even when it does not detect a trigger condition. If no trigger condition occurs while the oscilloscope is waiting for a specific period (as determined by the time-base setting), it will force itself to trigger.

When forcing invalid triggers, the oscilloscope cannot synchronize the waveform, and the waveform seems to roll across the display. If valid triggers occur, the

display becomes stable on the screen.

Any factor results in the instability of waveforms can be detected by Auto Trigger, such as the output of Power supply.

NOTE: When horizontal control is set under 50 ms/div, Auto mode allows the oscilloscope not to capture trigger signal.

- **Normal:**

The Normal mode allows the oscilloscope to acquire a waveform only when it is triggered. If no trigger occurs, the oscilloscope keeps waiting, and the previous waveform will remain on the display.

- **Single:**

In Single mode, after pressing the Single key, the oscilloscope waits for trigger. While the trigger occurs, the oscilloscope acquires one waveform then stop.

3. Coupling:

Trigger coupling determines which signal component passing to the trigger circuit. Coupling types include AC, DC, LF Reject and HF Reject.

- **AC:** AC coupling blocks DC components and attenuate signal lower than 10 Hz.
- **DC:** DC coupling passes both AC and DC components.
- **LF Reject:** LF Reject coupling blocks DC component, and attenuates all signal with a frequency lower than 10 kHz.
- **HF Reject:** HF Reject coupling attenuates all signals with a frequency higher than 100 kHz.

4. Pre-trigger/delayed trigger:

The data is collected before and after trigger.

The trigger position is typically set at the horizontal center of the screen. In the full-screen display the 6div data of pre-trigger and delayed trigger can be surveyed. More data (14div) of pre-trigger and 1s delayed trigger can be surveyed by adjusting the horizontal  POSITION knob.

This feature is very useful to study the events that led up to the trigger point. Everything on the right of the trigger point is called post-trigger information.

Delay range (pre-trigger and post-trigger information) depends on the sweep speed selected.

5. Adjustable trigger sensitivity

To avoid the influence of noise from the physical world, and get the stable trigger, the trigger circuit has adopted Stickiness. In DS1000B series, the stickiness is adjustable from 0.1div-1.0div, which means when it sets to 1.0div; the trigger circuit will not affect any signal with peak-peak amplitude less than 1.0div, so as to avoid the influence of the noise.

To Set up the Sampling System

Figure 2-59 shows, the **Acquire** button at the MENU of the front panel.

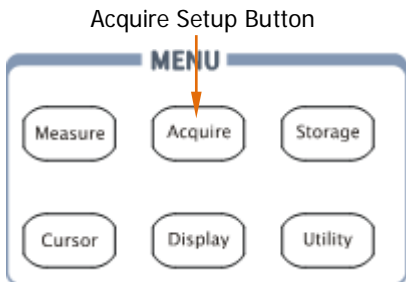

Figure 2-59
The Acquire setup button

Press **Acquire** button, the interface menu shows as follows:

Figure 2-60 Table 2-37 The Acquire menu



Menu	Settings	Comments
Acquisition	Normal	Normal Acquisition mode.
	Average	Average Acquisition mode.
	Peak Detect	Peak Detect Acquisition mode.
Averages ^[1]	2 to 256	Set average times by N-th power of 2 from 2 to 256.
Sampling	Real-Time	Real-time sampling mode.
	Equ-Time	Equivalent sampling mode.
Sinx/x ^[2]	ON OFF	Set the interpolation as Sinx/x. Set the interpolation as linearity.
Sa Rate ^[3]		Display sampling rate.

NOTES:

- [1] This function appears when acquisition as “Average”.
- [2] This function appears when sampling as “Real-Time”.
- [3] Sample rate channels will be displayed respectively in alternative trigger mode.

The waveform displayed on the screen will change in conjunction with the setting of Acquire menu.

- To reduce the displayed random noise, select the **Average** Acquisition. This mode would make the screen refresh slower.
- To Avoid signal aliasing, select **Peak Detect** Acquisition.
- Select **Real-time** acquisition to observe the single-shot or pulse signals.
- Select **Equ-Time** to observe high frequency repetitive signals.

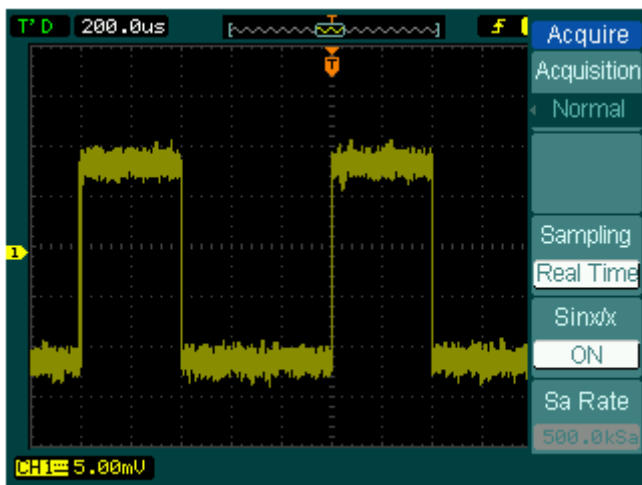

Figure 2-61

Signal that contains noise, and without average sampling

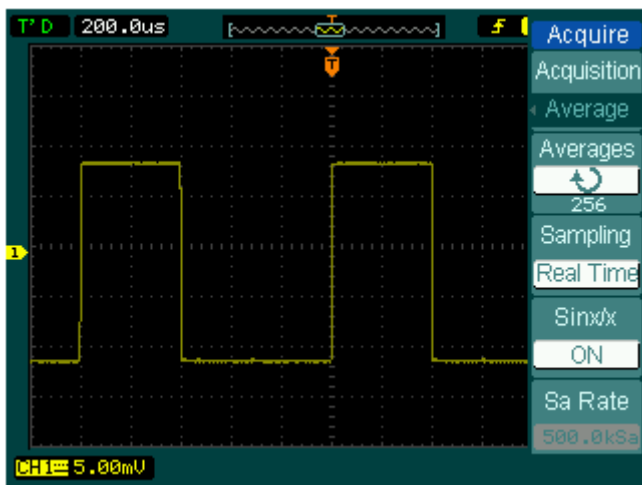

Figure 2-62

Display signal after average sampling

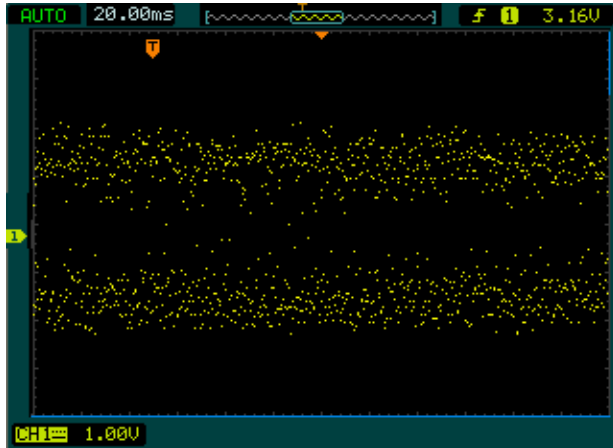

Figure 2-63
Adopt Normal acquisition

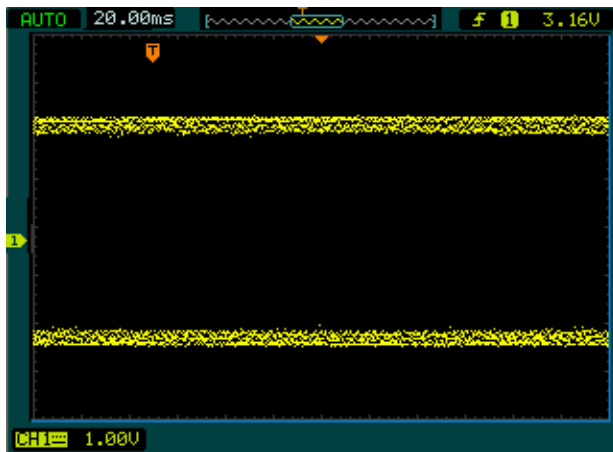

Figure 2-64
Adopt peak detect acquisition, signal contains envelope

Key points

Stop Acquisition: When the scope is acquiring waveforms, the waveforms is in a live status; when acquisition is stopped, frozen waveform will be displayed, the position and scale can still be adjusted by vertical control and horizontal control.

Key Points:**Real-time Sampling:**

DS1000B has Real-time sampling rate up to 2GSa/s. At the time base 20ns or faster, the oscilloscopes use the sine(x)/x interpolation to expand the horizontal time base.

Equivalent sampling:

Known as Repetitive sampling to get up to 20ps of horizontal resolution (equivalent 50GSa/s). This mode is good for observing repetitive signals, and it is not recommended for single-shot or pulse.

Normal Acquisition:

Oscilloscope acquires signal by equal time interval.

Average Acquisition:

Apply averaging to your signal to remove uncorrelated noise and improve measurement accuracy. Reduces random or uncorrelated noise in the signal display. The averaged waveform is a running average over a specified number of acquisitions from 2 to 256.

Peak Detect:

Peak Detect mode captures the maximum and minimum values of a signal, and finds highest and lowest record points over many acquisitions.

To Set up the Display System

The menu button for the display system on the front panel is shown in the following figure.

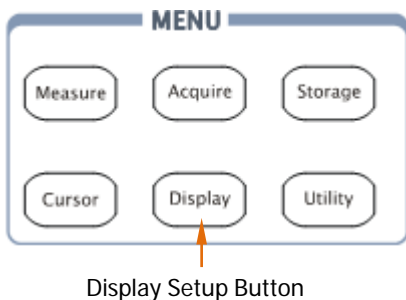

Figure 2-65 The display setup button

Press the **Display** button, the interface menu for settings shows as follows.

Figure 2-66 Table 2-38 The Display menu (Page 1/3)



Menu	Setting	Comments
Type	Vectors Dots	Display waveforms as vectors. Display waveforms as dots.
Clear		Clear all existing waveforms from screen.
Persist	Infinite OFF	The sample points remain displayed until turn the persistence "OFF". Turn off the persistence function.
Intensity	 <waveform intensity>	Set up waveform intensity (0% to 100%).

Figure 2-67 Table 2-39 The Display menu (Page 2/3)



Menu	Settings	Comments
Grading	ON OFF	The waveform is displayed in multiple levels of pixel intensity.
Grid	 	Display grids and coordinates on the screen. Turn off the grids. Turn off the grids and coordinates.
Menu Display	1s 2s 5s 10s 20s Infinite	Set the time before menu fades away. The menu will be hidden after the set time of last button pressing.

Figure 2-68 Table 2-40 The Display menu (Page 3/3)



Menu	Settings	Comments
GridBright	 <grid brightness>	Set up grid brightness (0% to 100%).
Screen	Normal Inverted	Set to normal mode. Set to invert color display mode.
Screen persist	 	To show the last acquired waveform when the acquisition is stopped. To show the accumulated acquired waveforms when the acquisition is stopped.
Skin	Classical Modern Tradition Succinct	To set the display screen of the oscilloscope

Term Explanations

Refresh rate: It is an important performance of digital oscilloscopes. It means the number of display refreshing per second and it will affect the ability to observe signal.

Adjusting waveform intensity

Default setup of multi-function knob (🔄) is adjusting waveform intensity.

To Store and Recall

Figure 2-69 shows the menu button for the storage system on the front panel.

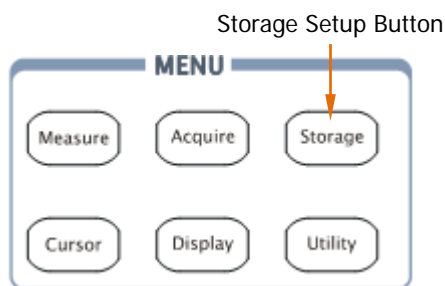

Figure 2-69 The storage setup button

Press the **Storage** button, the interface menu for settings shows as follows.

Figure 2-70 Table 2-41 The Storage menu (Waveform and Setups storage)



Menu	Settings	Comments
Storage [1]	Waveform ^[2]	Create, Save, Recall, Delete waveform files.
	Setups	Create, Save, Recall, Delete setups files.
	8-Bitmap	Create or delete 8bits bitmap files.
	24-Bitmap	Create or delete 24bits bitmap files.
	PNG	Create or delete PNG format files.
	CSV	Create or delete CSV files.
	Factory	Recall factory setups.
Internal		Go to menu for internal memory operation (see Table 2-46).
External		Go to menu for external memory operation (see Table 2-47).
Disk Mgr.		Go to disk manage menu (see Table 2-48).

NOTES:

[1] The waveform and setups files in internal memory can be created, saved, recalled and deleted. While, the waveform, setups, 8-bitmap, 24-bitmap, PNG, CSV files can be created and deleted.

[2] Both waveforms and status settings could be saved in "Waveform Storage".

Figure 2-71 Table 2-42 The Storage menu (Bitmap storage)

Storage	Menu	Settings	Comments
Storage	Storage	8-Bitmap 24-Bitmap	Create or delete 8bits Bitmap files. Create or delete 24bits Bitmap files.
24-Bitmap	Para Save	ON OFF	Save the current oscilloscope settings in different format with the same file name.
Para Save	External	/	Go to menu for external memory operation (see Table 2-47).
OFF	Disk Mgr.	/	Go to disk manage menu (see Table 2-48).
External			
Disk Mgr.			

Figure 2-72 Table 2-43 The Storage menu (PNG storage)

Storage	Menu	Settings	Comments
Storage	Storage	PNG	Create or delete PNG format files.
PNG	Para Save	ON OFF	Save the current oscilloscope settings in different format with the same file name.
Para Save	External	/	Go to menu for external memory operation (see Table 2-47).
OFF	Disk Mana.	/	Go to disk manage menu (see Table 2-48).
External			
Disk Mgr.			

Figure 2-73 Table 2-44 The Storage menu (CSV storage)



Menu	Settings	Comments
Storage	CSV	Create or delete CSV files.
Data Depth	Displayed Maximum	Save currently displayed waveform data to CSV file. Save the whole waveform data in memory to CSV file.
Para Save	ON OFF	Save the current oscilloscope settings in different format with the same file name.
External		Go to menu for external memory operation (see Table 2-47).
Disk Mana.		Go to disk manage menu (see Table 2-48).

Figure 2-74 Table 2-45 The Storage menu (Factory storage)



Menu	Settings	Comments
Storage	Factory	Recall factory setups.
Recall		Recall factory setups or files.
Disk Mana.		Go to disk manage menu (see Table 2-48).

Internal Memory

Press **Storage** → **Internal** to go to the following menu.

Figure 2-75 Table 2-46 The Memory menu



Menu	Settings	Comments
Internal	Int_00 (S) Int_01 (S) . . Int_09 (N)	Set up the location of files in internal memory among Int_00 to Int_09. Thereinto, S in brackets indicates the location has storage file, N indicates has not.
Recall		Recall waveform files and setup files from the internal memory location.
Save		Save waveform files and setup files to the internal memory location.
Delete File		Delete selected files.

NOTE: To ensure the setups being saved properly, only after the settings are changed for more than 5 seconds can the user turn off the instrument. The oscilloscope can store 10 settings permanently and can restore at anytime.

External Memory

Press **Storage** → **External** to go to the following interface.

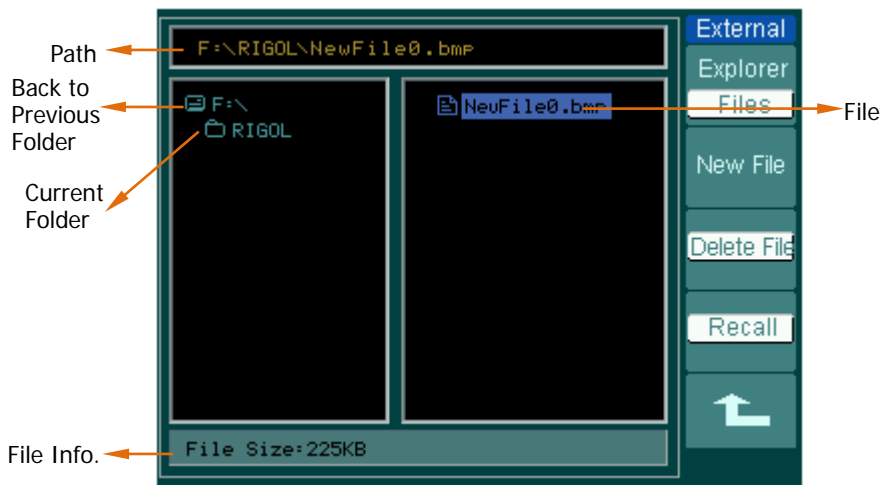

Figure 2-76 External memory interface

Figure 2-77 Table 2-47 The Memory menu



Menu	Settings	Comments
Explorer	Path Directories Files	Switch among Path, Directory and File.
New File (Folder)		To create new file or folder.(see table 2-18)
Delete File (Folder)		Delete file (Folder).
Recall		Recall waveform and setup from USB flash device.

U-disk Selection

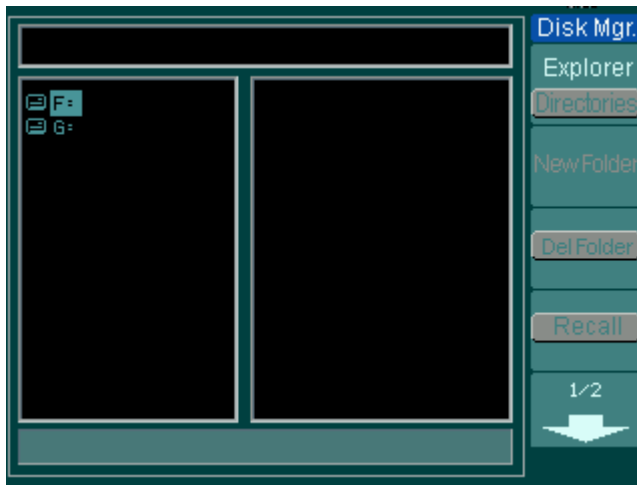

Figure 2-78 U-disk selection

DS1000B series have two USB Host ports on the front and rear panel. When both ports were inserted USB flash drive, the screen will appear a U-disk selection interface as Figure 2-78. Turn the multifunction knob to choose the driver. The front one marked "F:" and the rear one "G:".

Disk Management

Press **Storage** → **Disk Mgr.** Then go to the following menu.

Figure 2-79 Table 2-48 The Disk Management menu (Page 1/2)



Menu	Settings	Comments
Explorer	Path Directories Files	Switch among Path, Directory and File.
New folder		To create new folder (same as new files, see table 2-18).
Delete File		Delete selected file.
Recall		Recall waveform, setup, recorded waveform, Pass/Fail file.

Figure 2-80 Table 2-49 The Disk Management menu (Page 2/2)



Menu	Settings	Comments
Rename		To rename a file (see Table 2-50).
Disk info		Display disk information.

1. Disk Information

Press **Storage** → **Disk Mgr.** → **Disk info** to go to the disk information interface.

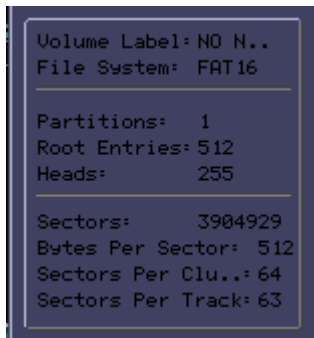

Figure 2-81 Disk information interface

2. Rename

Press **Storage** → **Disk Mgr.** → **Rename** to go to the following interface.



Figure 2-82 Rename the file

Figure 2-83 Table 2-50 The Rename menu

Rename	Menu	Settings	Comments
↑ ↓	↑ ↓	/	To move the input focus point of file name up and down.
↻	↻		To move the focus point to the next location.
X	X	/	To delete chosen letter.
Ok	OK		Rename the file.

Key point

Factory: The oscilloscope has default settings and can be recalled at anytime by user.

Memory location: Specify the memory location to save/recall the waveforms and setups.

Recall: Recall saved waveforms, setups and default settings.

Save: Save waveforms and setups.

To Set up the Utility

Figure 2-69 shows the menu button for the utility system on the front panel.

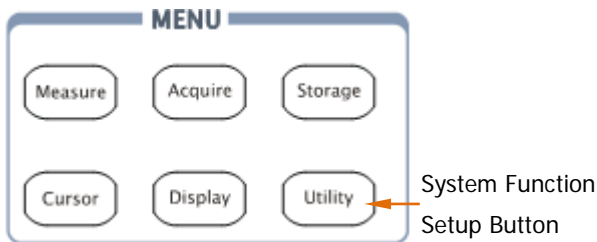

Figure 2-84

The Utility setup button

Press the **Utility** button to show the menu of the settings in the Utility system.

Figure 2-85 Table 2-51 The Utility menu (Page 1/3)



Menu	Setting	Comments
I/O setting		Setup I/O configuration.
Sound	(ON) (OFF)	Turn beeper sound on/off.
Counter	OFF ON	Turn off Frequency Counter. Turn on Frequency Counter.
Language	简体中文 繁體中文 한국어 日本語 English Deutsch Français Italiano Русский Português Español	Select languages. (More languages may be added in later firmware versions.)

Figure 2-86 Table 2-52 The Utility menu (Page 2/3)



Menu	Settings	Comments
Pass/Fail		Setup Pass/Fail test.
Record		Setup Waveform Recorder.
Print set		Setup printing.

Figure 2-87 Table 2-53 The Utility menu (Page 3/3)

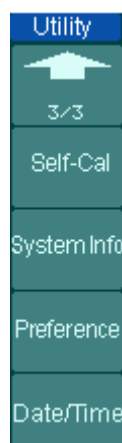

Menu	Settings	Comments
Self-Cal		Execute Self-calibration.
System Info		Show the following information: Serial number, software version, installed module.
Preference		Go to preference menu.
Date/Time		Set the real date and time for system.

Term Explanations

Self-Cal: Oscilloscope will calibrate parameters of the vertical system (CH1, CH2, CH3, CH4 and Ext), horizontal system and trigger system to make sure that the oscilloscope can normally work under different environments.

The I/O Setup

Press **Utility** → **IO Setting** to go to the following menu.

Figure 2-88 Table 2-54 The I/O Setup menu



Menu	Display	Comments
LAN Set		Set network function, the local area network interface corresponds with the LXI standard.
USB Device ^[1]	Auto Detect Computer PictBridge	Set USB device function, connect USB interface to the needed device.
GPIB#	0~30	Set the GPIB address.

NOTE [1]:

If the instrument connection switches from “Computer” (or PictBridge printer) into PictBridge printer (or Computer), you should set the type of **USB Device** manually, to ensure a same connection type between instruments under use.

1. LAN Setting

Access the oscilloscope into Network, and press **LAN Set** to enter the setting interface, see figure below:

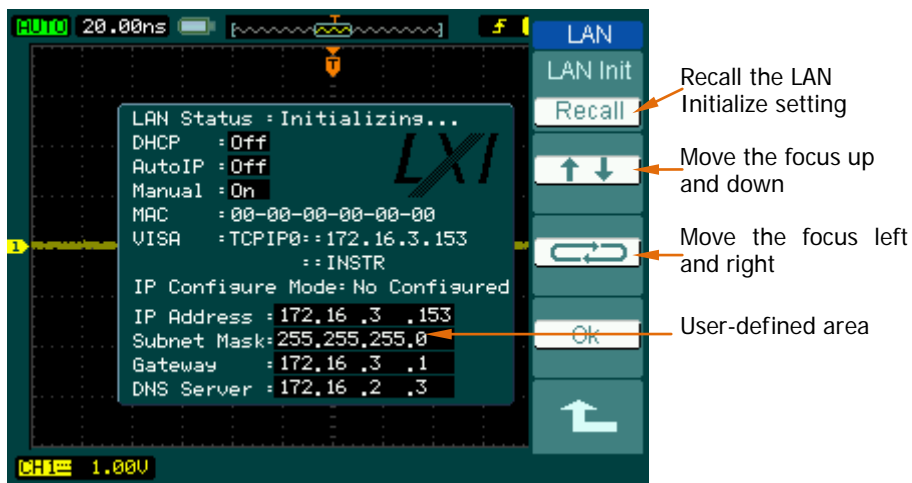

Figure 2-89 LAN Setting interface

The items under the black background in the setting area are available for current setting. Enter the desired parameter type or parameters for those items with the knob press down or rotating.

Key Points

There are three levels patterns of IP address from highness to lowness by Priority: DHCP, Auto IP and Manual IP.

- DHCP (Dynamic Host Configuration Protocol): assigning the IP address, subnet mask and the default gateway through the DHCP server in TCP/IP network on the basis of current configuration. Set the item ON to use the DHCP.
- Auto IP: generating an IP address within 169.254.0.1 and 169.254.255.254 in connection with a subnet mask automatically from the host. Disable the DHCP and set the Auto IP On before you use it.
- Manual IP: entering the IP address manually. If use this type, neither DHCP nor Auto IP should be "Off".

2. Remote Control

(1) By Web Page

When the network configuration is completed, open the IE and enter the IP address of oscilloscope, it will enter the interface with relative information below.

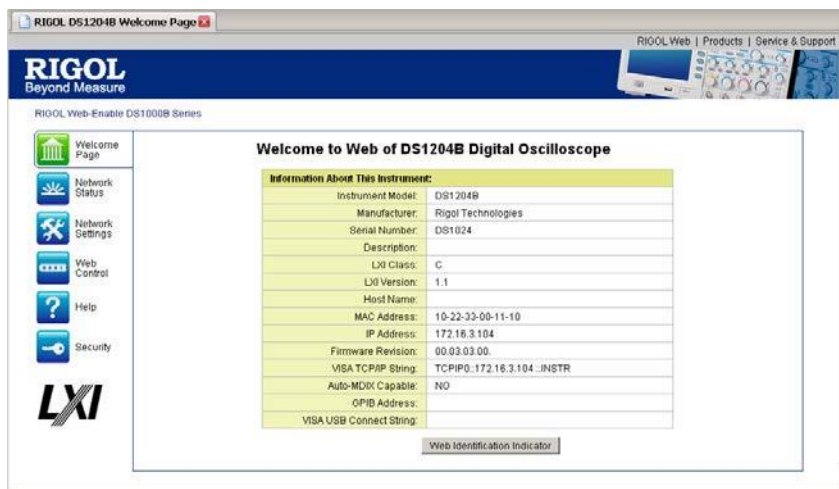

Figure 2-90 Remote control interface

Click “Web Control” and set the corresponding parameters listed in the window below using the mouse.



Figure 2-91 Remote control window

(2) By Commands

DS1000B is a USB TMC (USB Test & Measurement Class) instrument, which could be controlled by commands on the basis of NI-VISA (NI-National Instrument, VISA-Virtual Instrument Software Architecture) or Agilent-VISA (for the details about commands, refer to the relative Programming Guide). USB or network is recommended for the communication between the instrument and a PC to integrate it into your testing system.

The library related to VISA should be installed before using it. If both the NI-VISA and Agilent-VISA were installed in your computer, it would automatically identify the available VISA driver. Only one VISA driver is recommended to be used in a computer such as NI-VISA (visit www.ni.com to download). Here we show you NI-VISA as an example:

- **Make a connection by network**
- After the network is properly connected, the oscilloscope will automatically detect it and make configuration.
- In **Measurement & Automation Explorer**, select “Device and Interface” → “Create New”.

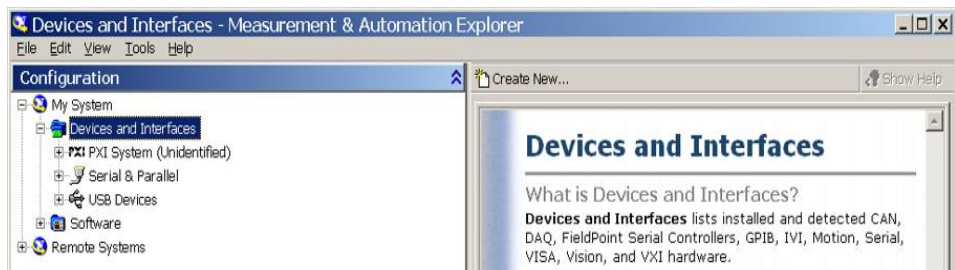

Figure 2-92
Measurement & Automation Explorer interface

- Select “VISA TCP/IP Resource” in the dialog “Create New...” appeared.

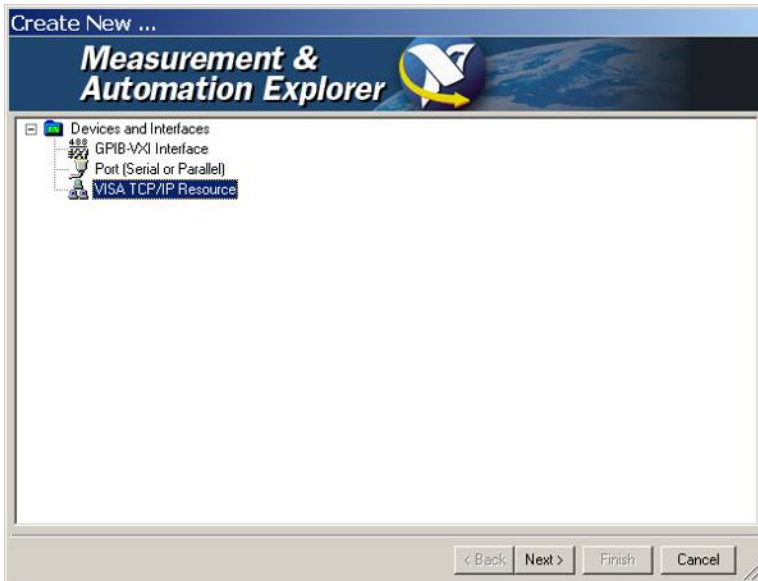

Figure 2-93
VISA TCP/IP Resource interface

- ❑ Click “Next” and select “Auto-detect of LAN Instrument”.

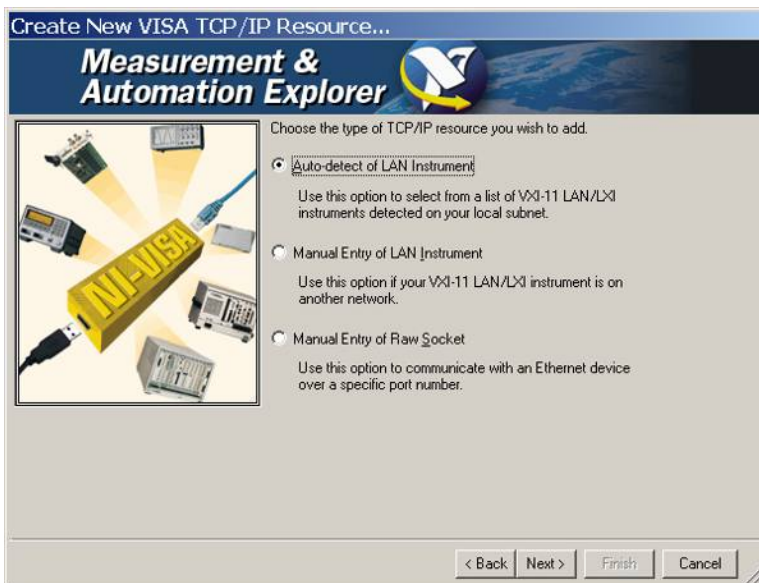

Figure 2-94
Auto-detect of LAN Instrument interface

- ❑ The software searching the available network device automatically.

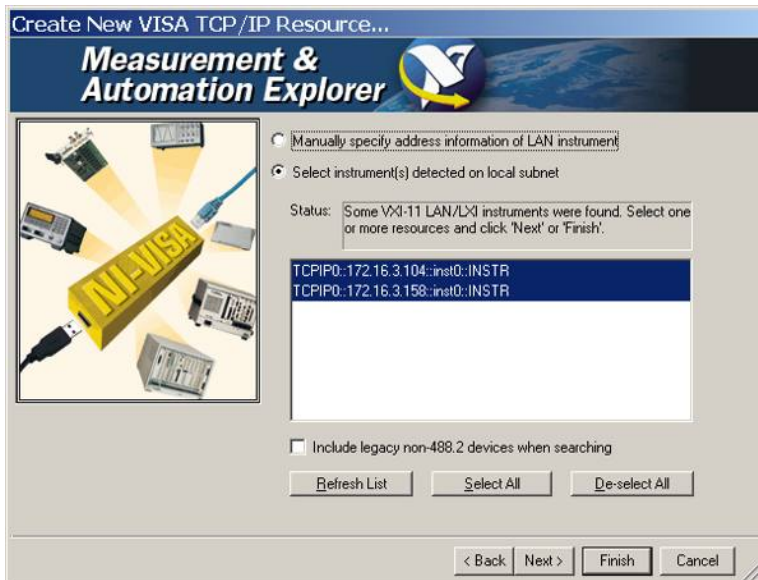

Figure 2-95

Search the network device interface

- ❑ Click “Finish” and you will see the oscilloscope that has been accessed to the network from the subdirectory “VISA TCP/IP Resource” under the main Explorer interface.

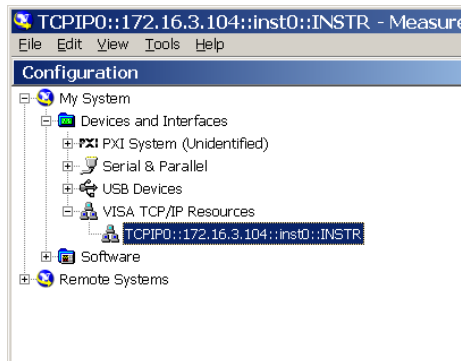

Figure 2-96

Subdirectory of VISA TCP/IP Resource

- ❑ Choose a relative resource and open the communication testing panel to send commands and read the data.

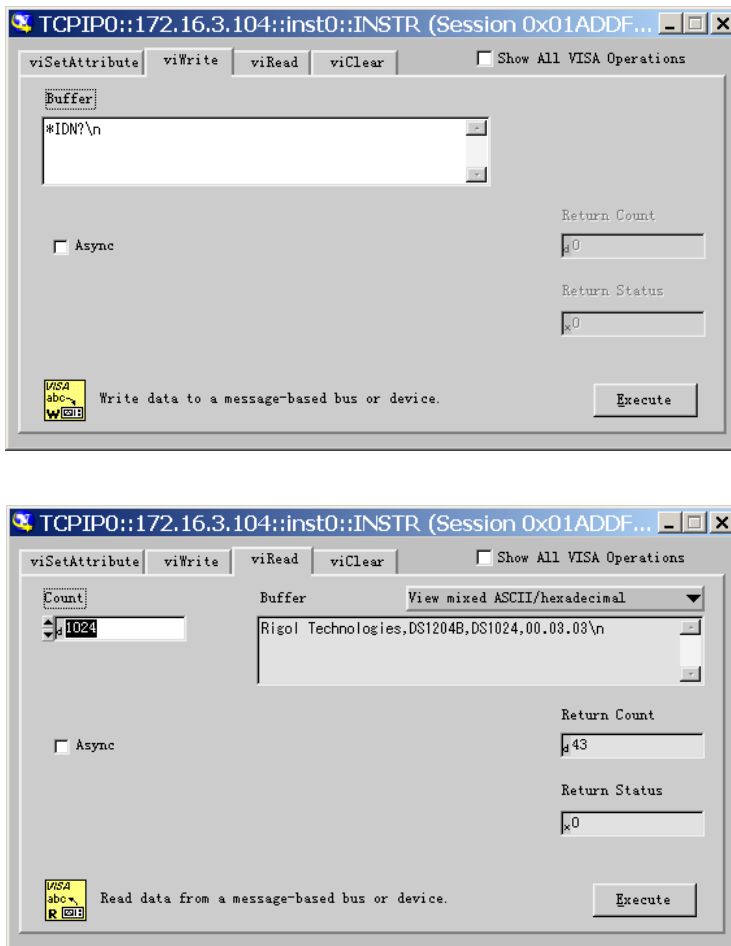

Figure 2-97
Communication testing dialog

- **Make a connection by USB**

- ❑ Connect the oscilloscope to a PC by using a USB data cable. Then, turn on the oscilloscope, at the moment, the computer will pop up a Hardware Installation wizard and please install the “USB Test and Measurement Device” according to the wizards.
- ❑ After installation, open **Measurement & Automation Explorer** and you will see the information about USB device that has been connected in the subdirectory.

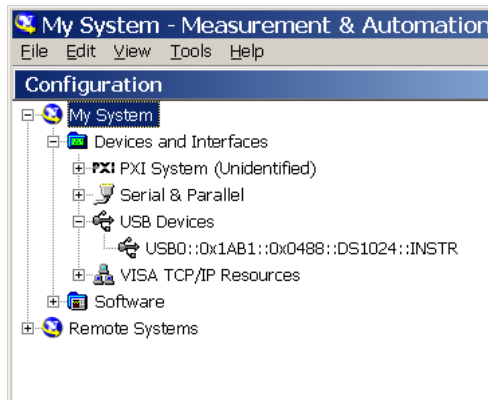

Figure 2-98
Measurement & Automation Explorer interface

- ❑ Select the responding resource and open the VISA Test Panel to send commands and read data.

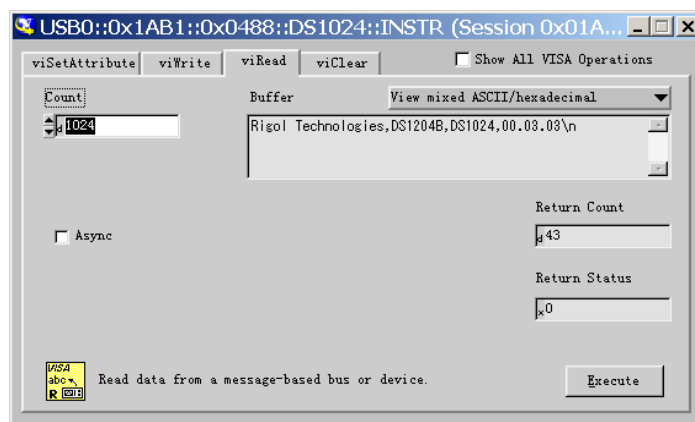
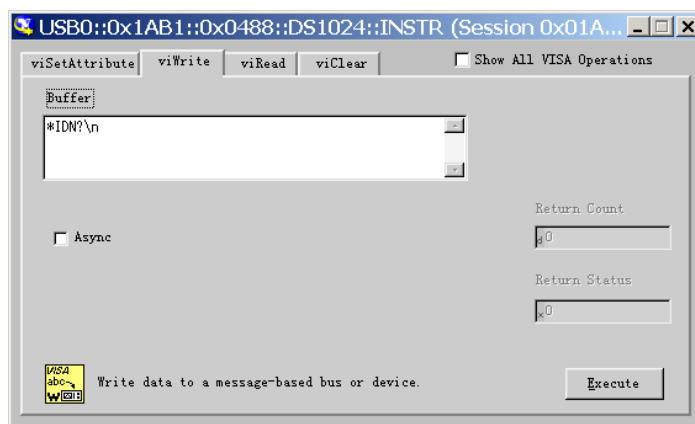

Figure 2-99 Communication testing dialog

Language

The DS1000B series oscilloscopes have multi-language user menu, choose as your desire.

Press **Utility** → **Language** to select the language. Press button No.4 until the desired language appears.



Figure 2-100 Language selection screen

Pass/Fail

The Pass/Fail function monitors changes of signals by comparing the input signal which is within the pre-defined mask. The testing results not only can be displayed on screen, but also can be alarmed by opening the system sound settings.

Press **Utility** → **Pass/Fail** to go to the following menu.

Figure 2-101 Table 2-55 The Pass/Fail menu (Page 1/2)

Menu	Setting	Comments
Enable Test	ON OFF	Turn on Pass/Fail test. Turn off Pass/Fail test.
Source	CH1, CH2, CH3, CH4	Select Pass/Fail test on CH1, CH2, CH3 or CH4.
Operate	▶ (RUN) ■ (STOP)	Pass/Fail test stopped, press to run. Pass/Fail test running, press to stop.
Msg display	ON OFF	Turn on Pass/Fail information display. Turn off Pass/Fail information display.

Figure 2-102 Table 2-56 The Pass/Fail menu (Page 2/2)

Menu	Settings	Comments
Output	Fail Fail + 🔊 Pass Pass + 🔊	Output when Fail condition detected. Output and beep when Fail condition detected. Output when Pass condition detected. Output and beep when Pass condition detected.
Stop on Output	ON OFF	Stop test when output occur. Continue test when output occur.
Mask Setting		Go to mask setting menu.

1. Mask setting

Press **Utility** → **Pass/Fail** → **Mask Setting** to go to the following menu.

Figure 2-103 Table 2-57 The Mask setting menu (Page 1/2)





Menu	Settings	Comments
X Mask	 <x div>	Set horizontal clearance to the waveform (0.04div-4.00div).
Y Mask	 <y div>	Set vertical clearance to the waveform (0.04div-4.00div).
Create Mask		Create a test mask according to the above clearance.
Location	Internal External	Set the memory location of the mask files.

Figure 2-104 Table 2-58 The Mask setting menu (Internal, Page 2/2)



Menu	Settings	Comments
Save		Store created test mask into internal memory.
Recall		Recall mask setting file from internal memory.
Imp./Exp.		Go to import/export menu (same as REF import/export menu. see table 2-15).

Figure 2-105 Table 2-59 The Mask setting menu (External, Page 2/2)

Mask	Menu	Settings	Comments
2/2	Save		Go to save menu (same as REF save menu, see table 2-16).
Save	Recall		Go to recall menu (see Table 2-63).
Recall	Import		Go to import menu. (Same as REF import menu, see table 2-18).
Import			
↑			

2. Recall

Press **Utility** → **Pass/Fail** → **Mask Setting** → **Recall** to recall the setting file from internal/external memory.

Figure 2-106 Table 2-60 The Recall menu

Recall	Menu	Settings	Comments
Explorer	Explorer	Path Directories Files	Switch among Path, Directory and File.
Files	Recall		Recall the specified file from external memory.
Recall			
↑			

NOTE: Pass/Fail function is unavailable in X-Y mode.

Waveform Recorder

Waveform recorder records input waveforms from CH1, CH2, CH3 and CH4 with a maximum record length of 800 frames. This performance can also be activated by the Pass/Fail test, which makes this function especially useful to capture abnormal signals in long term without keeping an eye watching it.

1. **OFF:** It will close all record functions.
2. **Record:** To record waveform by selected time interval till the last frame.

Press **Utility** → **Record** → **Mode** → **Record** to go to the following menu.

Figure 2-107 Table 2-61 The Record menu (Page 1/2)



Menu	Settings	Comments
Mode	OFF Record Play back Storage	Select record mode. Select play back mode. Select storage mode. Turn off all recorder functions.
Source	CH1, CH2 CH3, CH4 P/F-OUT ^[1]	Select record source channel.
End Frame	 <1-800>	Set number of record frames.
Operate	(Run) (Stop)	Record stopped, press to Start recording. Press to stop recording.

NOTE [1]: The waveform when Pass/Fail testing pass or fail.

Figure 2-108 Table 2-62 The Record menu (Page 2/2)



Menu	Settings	Comments
Interval	<1.00ms-1000s>	Set time interval between record frames.

3. Play Back: Play back the recorded waveforms.

Figure 2-109 Table 2-63 The Play Back menu (Page 1/2)



Menu	Settings	Comments
Operate	(Run)	Play stopped, press to Start playback.
	(Stop)	Press to stop playing.
Play mode		Set repeat play mode.
		Set single time play mode.
Interval	<1.00ms-20s>	Set up interval value between frames.

Figure 2-110 Table 2-64 The Play Back menu (Page 2/2)

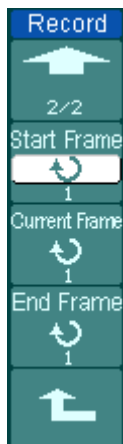

Menu	Settings	Comments
Start Frame	<1-800>	Set start frame.
Current Frame	<1-800>	Select current frame to be played.
End Frame	<1-800>	Set End frame.

Run/Stop Button

The **Run/Stop** button can also replay or continue the waveform display. The Current Frame will go forward one frame by pressing **Single** button in **Play back** mode.

- 4. **Storage:** Store recorded waveforms in non-volatile memory according to the setup frames.

Figure 2-111 Table 2-65 The Storage menu (Page 1/2)

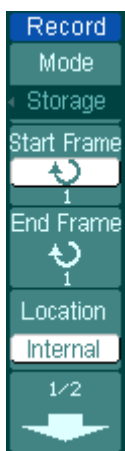



Menu	Settings	Comments
Start Frame	 <1-800>	Set first frame to be saved.
End Frame	 <1-800>	Set last frame to be saved.
Location	Internal external	Set up Store location.

Figure 2-112 Table 2-66 The Storage menu (Internal location Page 2/2)





Menu	Settings	Comments
Save		Save recorded waveform to internal memory location.
Recall		Recall recorded waveform from internal memory location.
Imp./Exp.		Go to import/export menu (Same as REF import/export menu. see table 2-14).

Figure 2-113 Table 2-67 The Storage menu (External location Page 2/2)

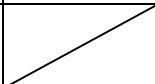
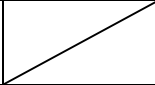

Menu	Settings	Comments
Save		Go to save menu (same as REF save menu. see table 2-160).
recall		Go to recall menu (see Table 2-63).
Import		Go to import menu. (Same as REF import menu, see table 2-18).

Print Setting

DS1000B series oscilloscopes support two print modes: “normal” and “PictBridge”. Please execute print operation according to the following steps:

1. Connect printer:

- If use PictBridge printer, please select “**PictBridge**” mode, and then connect the oscilloscopes regarded as “Device equipment” and printer via USB Device port on the rear panel.

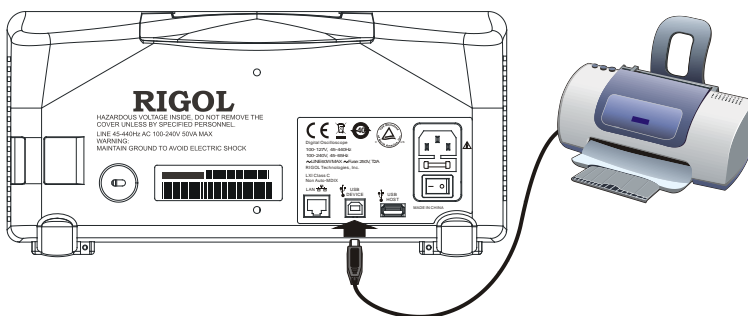

Figure 2-114 PictBridge print

- If use Normal printer, please select “**Normal**” mode, and then connect the oscilloscopes regarded as “Host equipment” and printer via USB Host port on the front panel.

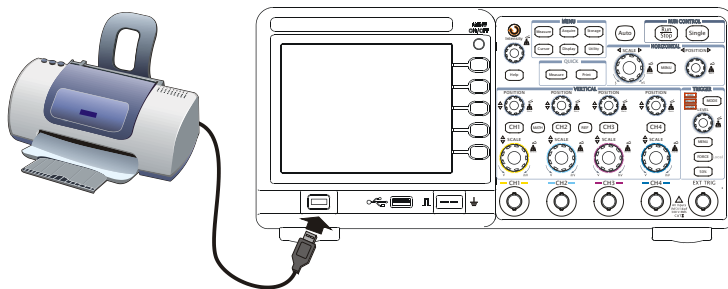



Figure 2-115 Normal print

2. To set up print parameters:

Press **Utility** → **Print set** to into a setting menu. Please setup the printer type and the print mode as the case may be, or else the instrument will refuse printing if they can't match well.

- Press **PrintMod** button, choose the print mode as Normal, and navigate into the following menu.

Figure 2-116 Table 2-68 Print Set menu (Normal mode)

	Menu	Settings	Comments
	PrintMod	Normal PictBridge	Set the print mode as normal. Set the print mode as PictBridge.
	Print		Execute the print operation.
	Inverted	ON OFF	Invert the color for print. Print original color.
	Palette	Gray scale Color	Set up the print color.

- Press **PrintMod** button, choose the print mode as PictBridge, and navigate into the following menu.

Figure 2-117 Table 2-69 Print Set menu (PictBridge mode, Page 1/4)

	Menu	Settings	Comments
	PrintMod	Normal PictBridge	Set the print mode as normal. Set the print mode as PictBridge.
	Print Continue		Execute the print operation. The menu will turn to "Continue" once appears recoverable error. To print continuously, press this button.
	Abort		Abort the printing.
	Status		Inquire about the current status of the printer.

Figure 2-118 Table 2-70 Print setup menu (PictBridge mode, Page 2/4)



Menu	Settings	Comments
Paper size	Default, A2, A3, A4, A5, A6, B5	Select the paper size for printing.
File type	Default Exif/Jpeg Bmp	To specify the image type for printing as Exif/Jpeg or Bmp format.
copies	1~999	To set the print copies from 1to 999.

Figure 2-119 Table 2-71 Print setup menu (PictBridge mode, Page 3/4)





Menu	Settings	Comments
Print Quality	Default Normal Draft fine	To specify the print quality.
Data print	Default ON OFF	To turn on or off the print date.
inverted	ON OFF	Turn on the inversion of printing color Turn off the inversion of printing color

Figure 2-120 Table 2-72 Print setup menu (PictBridge mode, Page 4/4)



Menu	Settings	Comments
palette	Grayscale Color	To set the print image as grayscale or color.

3. Print:

Make sure the Printer has been connected and the print settings are all ready before printing. Then, press **Utility** → **Print** or press  to execute print operation, If you want to go on printing, please use the  button.

Self-Calibration

The Self-Calibration adjusts the internal circuitry to get the best accuracy. Use this function to calibrate the vertical and horizontal systems. For maximum accuracy at any time, run this calibration if the ambient temperature changes by 5°C or more.

Before running this procedure, make sure that disconnect any probes or cables from all channel inputs, otherwise failure or damage to the oscilloscope may occur. Then, press the **Utility** → **Self-Cal**.



Figure 2-121 The Self-Calibration menu

NOTE: The oscilloscope must have been working or warm-up **at least 30-minutes** before running self-calibration to get best accuracy.

System Information

Press **Utility** → **System Info** to view the system information, including Model, Serial Number, Software version and installed module.

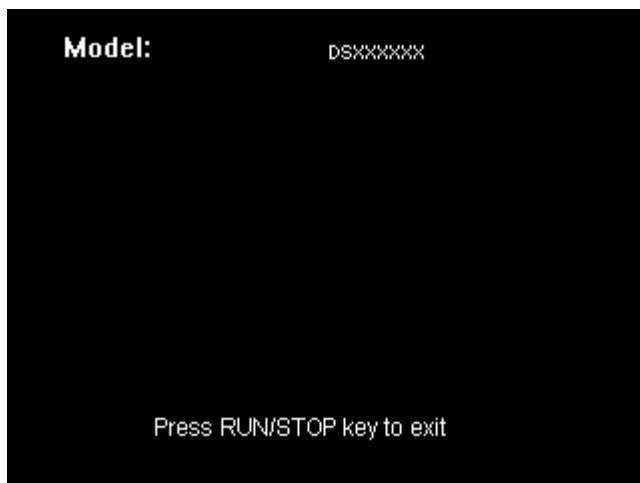

Figure 2-122 Information system interface

Preference

Press **Utility** → **Preference** to go to the following menu

Figure 2-123 Table 2-73 The Preference menu



Menu	Display	Comments
Screen saver	1 min ... 5 hour OFF	Set up screen saver timer.
Expand	Ground Center	Set up waveform vertical expand reference.
Stickykey		Turn the sticky status of CH1, CH2, CH3, CH4, MATH, REF, Trig.Lev. and Trig.Pos. on or off.
Default Load	Last set Default	Use the last setup in the next power on. Use the default setup of the system in the next power on.

Key Points

Screen saver: This function extends the life of LCD backlighting system.

Expand reference: When changing the volts/div. for channels, the signal expands or compresses around the signal ground level, or the center of the screen. When **Center** is selected, the waveform will expand or compress around the center of the display. When **Ground** is selected, the channel ground level will remain the same position on the display and waveform will zoom about the ground level.

Sticky key: If sticky feature is turned ON, when adjusting positions (CH1, CH2, CH3, CH4, MATH, REF, Trig.Lev. and Trig.Pos.), the waveform will stop at zero position until next adjustment, for the ease of getting back to initial positions.

Date and Time

DS1000B Series provide build-in system real-time date and time. Users can set the date and time as shown in the following figure.

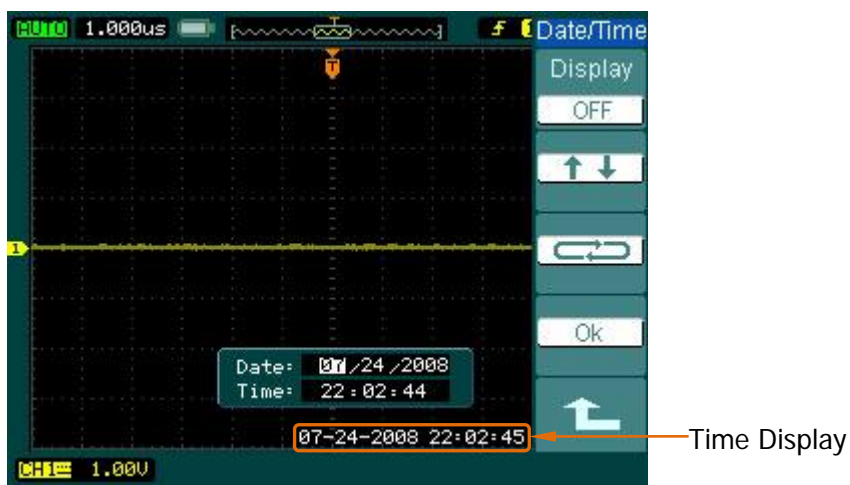

Figure 2-124 Date and time setting

Figure 2-125 Table 2-74 Time setting menu



Menu	Settings	Comments
Display	OFF ON	Close time display Open time display
↑ ↓		Move up/down the setting focus
↔		Move left/right the setting focus
OK		Save the current settings

To Measure Automatically

The **Measure** button in the menu area activates the automatic measurement function. The instruction below shows the powerful measurement function of DS1000B series oscilloscopes.

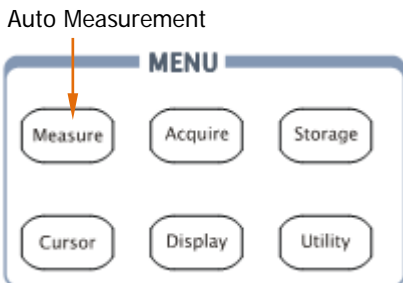

Figure 2-126
The Measure setup button

The oscilloscopes provide 22 auto measurements: Vpp, Vmax, Vmin, Vtop, Vbase, Vamp, Vavg, Vrms, Overshoot, Preshoot, Freq, Period, Rise Time, Fall Time, Delay A → Bf, Delay A → Bt, Phase A → Bf, Phase A → Bt, +Width, -Width, +Duty, -Duty (10 voltage and 12 timing measurements).

Press the **Measure** button to display the menu of the Automatic Measurements settings.

Figure 2-127 Table 2-75 The Measure menu (Page 1/2)



Menu	Settings	Comments
Source	CH1, CH2, CH3, CH4	Select CH1 or CH2 as source channel for measurement.
Voltage		Select measure voltage parameter.
Time		Select measure time parameter.
Clear		Clear measurement result on screen.

Figure 2-128 Table 2-76 The Measure menu (Page 2/2)



Menu	Settings	Comments
Display All	OFF ON	Turn off all measurements result. Turn on all measurements result.
QuickMea		To specify three quick measure items which you can choose among the above 22 measurements.
Delay/Phase Setup		To configure the delay and phase channels, in order to measure delay and phase value relative to time measurement between any two vertical channels form CH1 to CH4.

Quick Measurement Setup

Press **Measure** → **QuickMea** button, go to the quick measure menu.

Figure 2-129 Table 2-77 Quick measure menu

Quick M	Menu	Settings	Comments
Item1	Item1	/	To specify Item1, Item2 and Item3 respectively, each item can be chosen from 22 kinds of measure items.
Freq	Item2	/	
Item2	Item3	/	
Vpp			
Item3			
Vavg			
			

Delay/Phase Setup

Press **Measure** → **Delay/Phase Setup** button, and go to the delay/phase setup menu.

Figure 2-130 Table 2-78 The delay/phase setup menu.

Menu	Settings	Comments
Delay A	CH1 CH2 CH3 CH4	To set CHA of Delay measurement as one of CH1,CH2,CH3,CH4
Delay B		
Phase A		To set CHA of Phase measurement as one of CH1,CH2,CH3,CH4
Phase B		

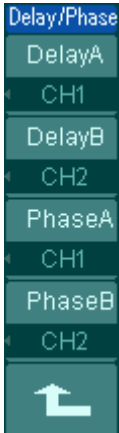

Voltage Measurements

The DS1000B series oscilloscopes provide automatic voltage measurements including V_{pp} , V_{max} , V_{min} , V_{avg} , V_{amp} , V_{rms} , V_{top} , V_{base} , Overshoot and Preshoot. Figure 2-131 below shows a pulse with some of the voltage measurement points.

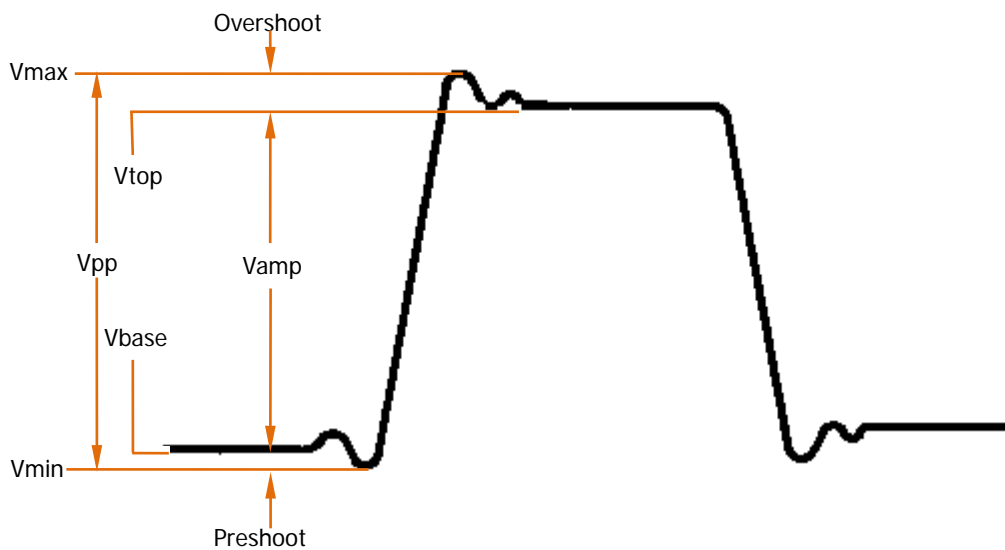

Figure 2-131 Voltage parameters

V_{pp} : Peak-to-Peak Voltage.

V_{max} : The maximum amplitude. The most positive peak voltage measured over the entire waveform.

V_{min} : The minimum amplitude. The most negative peak voltage measured over the entire waveform.

V_{amp} : Voltage between V_{top} and V_{base} of a waveform

V_{top} : Voltage of the waveform's flat top, useful for square/pulse waveforms.

V_{base} : Voltage of the waveform's flat base, useful for square/pulse waveforms.

Overshoot: Defined as $(V_{max}-V_{top})/V_{amp}$, useful for square and pulse waveforms.

Preshoot: Defined as $(V_{min}-V_{base})/V_{amp}$, useful for square and pulse waveforms.

Average: The arithmetic mean over the entire waveform.

V_{rms} : The true Root Mean Square voltage over the entire waveform.

Press **Measure** → **Voltage** button, and go to the following menu.

Figure 2-132 Table 2-79 The Voltage Measurement menu (Page 1/3)



Menu	Settings	Comments
Vmax		Measure maximum voltage of a waveform.
Vmin		Measure minimum voltage of a waveform.
Vpp		Measure Peak-to-Peak Voltage.
Vtop		Measure a flat top voltage of a square waveform.

Figure 2-133 Table 2-80 The Voltage Measurement menu (Page 2/3)

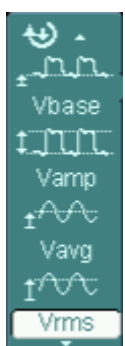

Menu	Settings	Comments
Vbase		Measure a flat base voltage of a square waveform.
Vamp		Measure voltage between Top and Base.
Vavg		Measure average voltage of a waveform.
Vrms		Measure Root Mean Square Voltage of a waveform.

Figure 2-134 Table 2-81 The Voltage Measurement menu (Page 3/3)



Menu	Settings	Comments
Overshoot		Measure overshoots in percentage of an edge.
Preshoot		Measure preshoot in percentage of an edge.

Time Measurements

The DS1000B series oscilloscopes provide 12 kinds of timing parameters auto-measurements: Frequency, Period, Rise Time, Fall Time, +Width, -Width, Delay A→B \uparrow , Delay A→B \downarrow , +Duty and -Duty, Phase A→B \uparrow , Phase A→B \downarrow .

Figure 2-135 shows a pulse with some of the time measurement points.

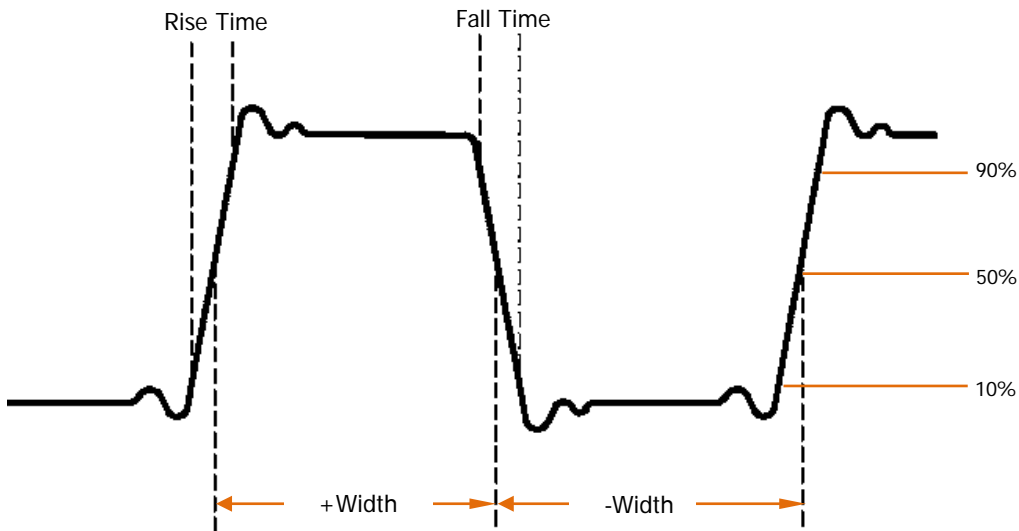

Figure 2-135 Time parameters

Rise Time: Time that the rising edge of the first pulse in the waveform takes to rise from 10% to 90% of its amplitude.

Fall Time: Time that the falling edge of the first pulse in the waveform takes to fall from 90% to 10% of its amplitude.

+Width: The width of the first positive pulse in 50% amplitude points.

-Width: The width of the first negative pulse in the 50% amplitude points.

Delay A→B \uparrow : The time delays between the channel A and channel B at the rising edge.

Delay A→B \downarrow : The time delays between the channel A and channel B at the falling edge.

Phase A→B \uparrow : The phase between the channel A and channel B at the rising edge.

Phase=(delay/source A period) \times 360°

Phase A→B \downarrow : The phase between the channel A and channel B at the falling edge.

+Duty: +Duty Cycle, defined as +Width/Period

-Duty: -Duty Cycle, defined as -Width/Period.

Press **Measure** → **Time** button, and go to the following menu

Figure 2-136 Table 2-82 The Time Measurement menu (Page 1/3)



Menu	Settings	Comments
Period		Measure Period of a waveform.
Freq		Measure Frequency of a waveform.
Rise time		Measure Rise Time of a rising edge.
Fall time		Measure Fall Time of a falling edge.

Figure 2-137 Table 2-83 The Time Measurement menu (Page 2/3)



Menu	Settings	Comments
+Width		Measure +Pulse Width of a pulse wave.
-Width		Measure –Pulse Width of a pulse wave.
+Duty		Measure +Duty Cycle of a pulse wave.
-Duty		Measure –Duty Cycle of a pulse wave.

Figure 2-138 Table 2-84 The Time Measurement menu (Page 3/3)

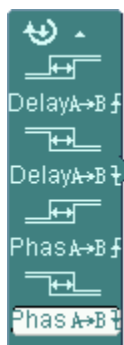

Menu	Settings	Comments
Delay A → B _f		Measure the signals delay between two channels at the rising edge.
Delay A → B _t		Measure the signals delay between two channels at the falling edge.
Phase A → B _f		Measure the phase difference between two channels at the rising edge
Phase A → B _t		Measure the phase difference between two channels at the falling edge

Key Points:

1. Select the signal channel for measuring. CH1, CH2, CH3, CH4 according to the interest. Press soft buttons as follows: **Measure**→**Source**→**CH1, CH2, CH3 , CH4**.
2. To see all measurement values, Press No.2 button to set the **Display All** to **ON**. 18 measurement parameters will be displayed on the screen.
3. Select parameters page for measuring; press No.2 or No.3 button to select voltage or time parameters pages by pressing soft button as follows: **Measure**→**Voltage** or **Time** →**Vmax, Vmin.....**
4. To get the measured value on the screen; select the parameters of interest by pressing the soft button on the right of the menu, and read the data on the bottom of the screen.
If the data is displayed as "*****", it means the parameter cannot be measured in current condition.
5. Clear the measure values: press No.4 button **Clear** to clear away all of the auto measure values would disappear from the screen.
6. In Display All mode, there are 18 types of parameters could be used and the measuring result up to 3 are shown below the screen. When the display area are filled up 3 results, the new one will be displayed on the very right instating of the earliest, meanwhile the other two results removed left in turn.

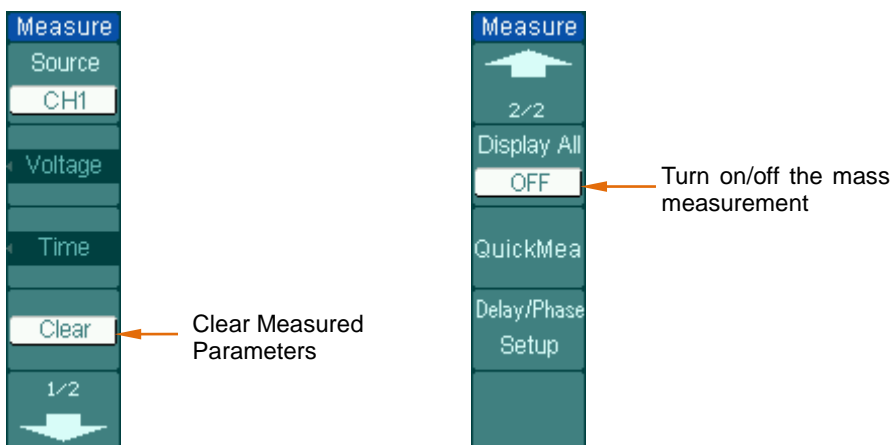

Figure 2-139 Explanation of the menu

To Measure with Cursors

Figure 2-140 shows the **Cursor** button on the front-panel.

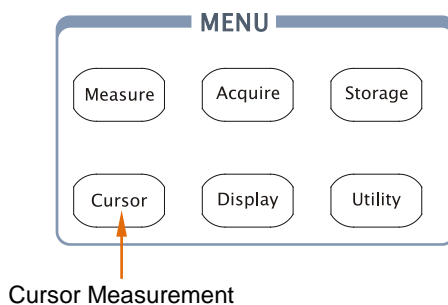

Figure 2-140 The Cursor setup button

The cursor measurement has three modes: Manual, Track and Auto Measure.

1. Manual

In this mode, the screen displays two parallel cursors. Move the cursors to make custom voltage or time measurements of the signal. The values are displayed on the boxes below the menu. Before using cursors, make sure to set the Signal Source as the channel for measuring.

2. Track

In this mode, the screen displays two cross cursors. The cross cursor sets the position on the waveform automatically. Adjust cursor's horizontal position on the waveform by rotating the multifunctional knob (↻). The oscilloscope displays the values of the coordinates on the boxes below the menu.

3. Auto Measure

This mode will take effect with Automatic Measurements. The instruments will display cursors while measuring parameters automatically. These cursors demonstrate the electrical meanings of these measurements.

NOTE: The Auto Measure mode for Cursor measuring will take no effect without automatic measurement.

Manual Mode

Press **Cursor** → **Mode** → **Manual** to display the manual mode menu.

Figure 2-141 Table 2-85 The Cursors menu



Menu	Settings	Comments
Mode	Manual	Adjust the cursor to measure X/Y parameters manually.
Type	X	Shown as vertical line to measure the time/frequency values.
	Y	Shown as horizontal line to measure the voltage values.
Source	CH1 CH2 CH3 CH4 MATH	Select the measurement signal source.

- Time values of a pair X cursors and time increment can be measured in manual mode when selecting **X** type. (Frequency values and its increment of a pair X cursors can be measured when selecting **MATH** source.)
- Voltage values of a pair Y cursors and time increment can be measured in manual mode when selecting **Y** type.

To do manual Cursor Measurements, please do as the following steps:

1. Select the Manual mode for cursor measurement by pressing soft button as: **Cursor** → **Mode** → **Manual**.
2. Select channel Source for measurements by pressing soft button as: **Cursor** → **Source** → **CH1**, **CH2**, **CH3**, **CH4**, **MATH**.
NOTE: While measuring the channel with MATH, the results are valued with “d” (division) as units.
3. Select the cursors type by pressing soft button as **Cursor** → **Type** → **X** or **Y**.
4. Move the cursors to adjust the increment between the cursors:(Details in the following Table)

Table 2-86 The Cursor menu

Cursor	Increment	Operation
Cursor A	X	Turn the multifunctional knob (↻) to move cursor A horizontally.
	Y	Turn the multifunctional knob (↻) to move cursor A vertically.
Cursor B	X	Turn the multifunctional knob (↻) to move cursor B horizontally.
	Y	Turn the multifunctional knob (↻) to move cursor B vertically.

NOTE: Cursor could be moved only when the curse function menu is displayed.

5. To get measurement values:

Position of Cursor A: Time cursor centered on the midpoint of screen; Voltage cursor centered on channel ground level.

Position of Cursor B: Same as above.

Horizontal space between cursor A and B (ΔX): Time between cursors ($1/\Delta X$), units in Hz, kHz, MHz, and GHz.

Vertical space between cursor A and B (ΔY): Voltage between cursors.

NOTE: The values will be automatically displayed on the right upper corner of screen when the cursor function menu is hidden or displaying other menus.

Term Explanations

Cursor Y: Cursors Y appear as horizontal lines on the display to measure vertical parameters. Usually it is used to measure the Volts. When the source is set as function, the units are assigned to the function.





Cursor X: Cursor X appears as vertical lines on the display to measure horizontal parameters. Usually it indicates the time of trigger excursion. When the source is set as FFT, X means frequency.

Track Mode

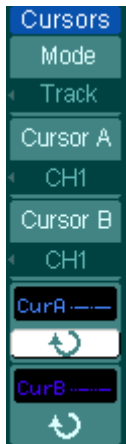
Press **Cursor** → **Mode** → **Track** to display the manual mode menu.

Figure 2-142 Table 2-87 Cursor descriptions



Menu	Settings	Comments
Mode	Track	Set Track mode in cursor measurement.
Cursor A	CH1 CH2 CH3 CH4 MATH None	Set Cursor A in conjunction with CH1. Set Cursor A in conjunction with CH2. Set Cursor A in conjunction with CH3. Set Cursor A in conjunction with CH4. Set Cursor A in conjunction with MATH. Turn off Cursor A i
Cursor B	CH1 CH2 CH3 CH4 MATH None	Set Cursor B in conjunction with CH1. Set Cursor B in conjunction with CH2. Set Cursor B in conjunction with CH3. Set Cursor B in conjunction with CH4. Set Cursor B in conjunction with MATH. Turn off Cursor B.
CurA (Cursor A)		Turn the multifunctional Knob () to move cursor A Horizontally.
CurB (Cursor B)		Turn the multifunctional knob () to move cursor B horizontally.

In cursor track mode, the cursors move together with the selected waveform.

To do Track mode Cursor Measurements, follow these steps:

1. Select the Track mode for cursor measurement by pressing soft button as: **Cursor** → **Mode** → **Track**.
2. Select channel Source for Cursor A and Cursor B by pressing soft button as: **Cursor** → **Cursor A** or **Cursor B** → **CH1**, **CH2**, **CH3**, **CH4**, **MATH** or **None**.
3. Move the cursors to adjust the horizontal positions of the cursors: (Details in the following Table)

Table 2-88 The Cursor usage

Cursor	Operation
Cursor A	Turn the multifunctional knob (↻) to move cursor A horizontally.
Cursor B	Turn the multifunctional knob (↻) to move Cursor B horizontally.

NOTE: Moving cursor horizontally is not allowed when other (not tracking cursor) menu is activated.

4. To get measurement values:

Position of Cursor A: Time cursor centered on the midpoint of screen; Voltage cursor centered on channel ground level.

Position of Cursor B: Time cursor centered on the midpoint of screen; Voltage cursor centered on channel ground level.

Read the horizontal space between Cursor A and B (ΔX): Time between cursors, units in seconds. ($1/\Delta X$), units in Hz, kHz, MHz, GHz

Vertical space between cursor A and B (ΔY): Voltage between cursors, units in V.

Auto mode

Press **Cursor** → **Mode** → **Auto** to display the manual mode menu.

Figure 2-143 Table 2-89 The Mode setting



Menu	Settings	Comments
Mode	Auto	Display the cursors for the current automatic measuring. (See the following figure).

There will be no cursor display if no parameters are chosen in Measure menu. The oscilloscope could move cursor automatically to measure 22 parameters in **Measure** menu.

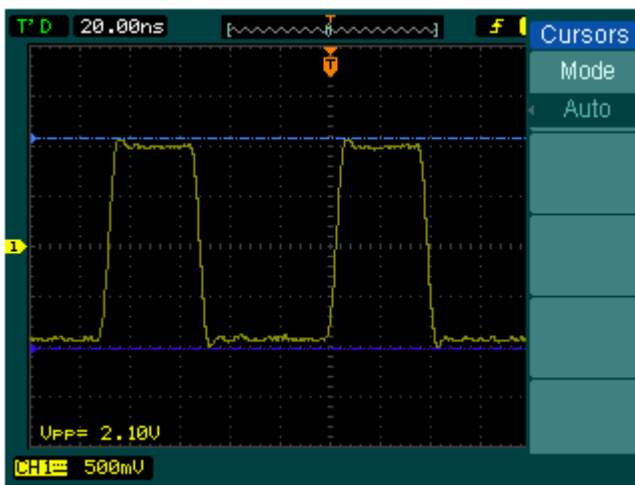



Figure 2-144
Auto Measure Mode of Cursor Measurement



To Use Run Control Buttons

The RUN control buttons include **Auto** (auto setting), **Run/Stop** and **Single**.

Auto: The **Auto** features automatic adjustments to produce a stable display of the input signal. Press **Auto** button, the following menu appears.

Figure 2-145 Table 2-90 The Auto menu

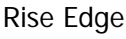

Menu	Settings	Comments
 Multi-Cycle	/	Press to display multi-cycle waveform on the screen.
 Single Cycle	/	Press to display single cycle waveform on the screen.
 Rise Edge	/	Press to display the waveform's rising edge and measure its rise time automatically.
 Fall Edge	/	Press to display falling edge of the waveform and measure its fall time automatically.
Undo	/	Press to cancel all the Auto Set actions, the oscilloscope will recover to its previous status.

Auto-Set functions

When the **Auto** is pressed the oscilloscope is configured to the following defaults:

Table 2-91 The Auto menu

Menu	Settings
Display format	Y-T
Acquire mode	Normal
Vertical Position	Adjusted to right position
Vertical "V/div"	Adjusted to right scale
Volts/Div	Coarse
Bandwidth limit	Full
Signal Invert	OFF
Horizontal position	Center
Horizontal "S/div"	Adjust to right position.
Trigger type	Edge
Trigger source	Find the channel with input signal automatically.
Trigger coupling	DC
Trigger voltage	Midpoint setting
Trigger mode	Auto

NOTE: The Bandwidth limit will turn on automatically as soon as measuring small signal.

Run/Stop: Run or Stop waveform acquiring.

NOTE: In Stop status, the volts/div and horizontal time base can be adjusted in a fixed limit. That is, to zoom in/out the signal in vertical and horizontal directions.

Single: When running, press this key to stop the oscilloscope, when stopped, press this key to make a single acquisition when the trigger occurs, then stop.

Chapter 3 Application Examples

Example 1: Taking Simple Measurements

The function is used to observe an unknown signal; to display, measure frequency, and peak-to-peak amplitude.

1. To quickly display a signal, please do the steps as follows:
 - (1) Set the probe and the channel attenuations to 10X.
 - (2) Connect signal to CH1 with the probe.
 - (3) Press the **Auto** button.

The oscilloscope sets the vertical, horizontal, and trigger controls at the best status automatically. To optimize the waveform display, adjust these controls manually to meet the requirements.

2. Selecting Automatic Measurements

The oscilloscope takes automatic measurements on most signals. To measure the frequency and the peak-to-peak amplitude, do these steps as follows:

(1) Measure peak-to-peak amplitude

Press **Measure** → **Source** → **CH1** to set the measurement source

Press **Voltage** → **Peak-Peak** to select the peak-to-peak measurements and the result will be displayed on the screen.

(2) Measure frequency

Press **Measure** → **Source** → **CH1** to set the measurement source

Press **Time** → **Freq** to select the frequency measurements and the result will be displayed on the screen.

NOTE: The frequency, period, and peak-to-peak measurements are shown on the screen and are updated periodically.

Example 2: View a Signal Delay Caused by a Circuit

This example is to test the input and output signals of a circuit and observe the signal delay. First, set the probe and the channel attenuation to 10X and connect CH1 probe to the input, CH2 to the output of the circuit. Do these steps as follow:

1. Display the signals (CH1 and CH2):
 - (1) Press the **Auto** button.
 - (2) Adjust the vertical and the horizontal scale by turning the **SCALE** knobs to set appropriate ranges for display.
 - (3) Press the **CH1** button to select Channel 1, and turn the vertical **POSITION** knob to adjust the vertical position of Channel 1 waveform.
 - (4) Press the **CH2** button to select Channel 2, and turn the vertical **POSITION** knob to adjust the vertical position of Channel 2 waveform.
2. Measure the delay time when a signal going through the circuit.

Auto-measuring the delay:
 Press **Measure** → **Source** → **CH1** to set the measurement source.
 Press **Time** to select the measurement Type.
 Press **Delay A → B** to display the result on the screen.

You can see the change of the waveform in the following figure:

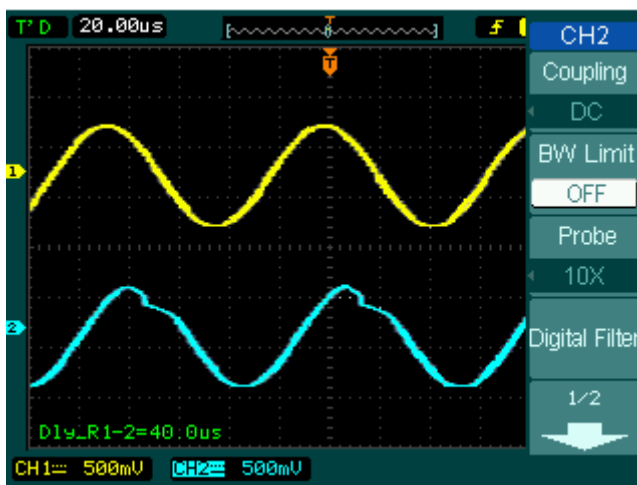

Figure 3-1 Waveform distortion

Example 3: Capture a Single-Shot Signal

To capture a single event, it needs to gather some pre-test knowledge of the signal in order to set up the trigger level and slope correctly. For example, if the event is derived from TTL logic, a trigger level of 2 volts should work on a rising edge. The following steps show how to use the oscilloscope to capture a single event.

1. Set the probe and the channel attenuations to 10X.
2. Set up the trigger.
 - (1) Press the **MENU** button in the Trigger control area to display the menu.
 - (2) Press **Edge** to select the trigger mode.
Press **Slope** to select **↑**.
Press **Source** to select **CH1**.
Press **Sweep** to select **Single**.
Press **Set Up** → **Coupling** to select **DC**.
 - (3) Turn the vertical and horizontal **SCALE** knobs to adjust the Volts/Div and the Time base in a proper range for the signal.
 - (4) Turn the **LEVEL** knob to adjust trigger level.
 - (5) Press **Run/Stop** button to start capturing. When the trigger conditions are met, data appears on the display representing the data points that the oscilloscope obtained with one acquisition.

This function helps to capture the occurrence easily, such as the noise with large amplitude; and set the trigger level higher a little above the normal level and press **Run/Stop** and wait. When noise occurs, the instrument will record the waveform before and after the trigger. Adjust the **POSITION** knob in the horizontal control area and change the level of the trigger position, will get the inverted delay trigger. It is useful to observe the waveform before the occurrence of the noise.

Example 4: To Reduce the Random Noise on a Signal

If the signal is noisy (Figure 3-2), set up the oscilloscope to reduce the noise on the waveform and avoid its interference to the signal.

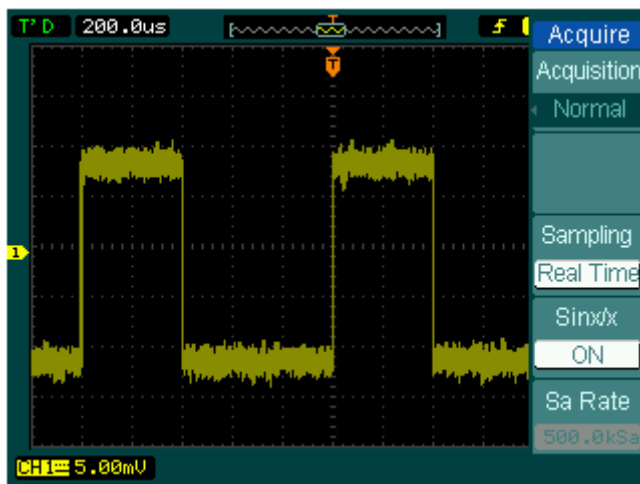

Figure 3-2 Signal with noises

1. Set the probe and the channel attenuations to 10X.
2. Connect a signal to the oscilloscope and obtain a stable display.
3. Improve the trigger by setting the Coupling.
 - (1) Press the **MENU** in the Trigger control area.
 - (2) Press **Set Up**→**Coupling** and select "LF Reject". Low frequency reject, namely adding a high pass filter, filters out the low-frequency signal components (lower than 10kHz) while allows high-frequency signal components to pass. Or press **Set Up**→**HF Reject** and select "ON". High frequency reject, namely adding a low pass filter, filters out the high-frequency signal components (greater than 100kHz, such as FM broadcast signal) while allows low frequency signal components to pass. Through **LF Reject** or **HF Reject**, low frequency or high frequency noise is rejected to obtain stable trigger.

4. To reduce the noise by setting the acquisition type and adjust the waveform intensity.
- (1) If there is noise within the signal and the waveform looks too wide, in this case, choose average acquisition. In this mode the waveform will be thin and easy to observe and measure.

To use average acquisition follows these steps.

- Press soft button as **Acquire** → Acquisition → Average
- Toggle the **Averages** soft button to select the number of averages that best eliminates the noise from the displayed waveform. It can be adjusted from 2 to 256. (See Figure 3-3)

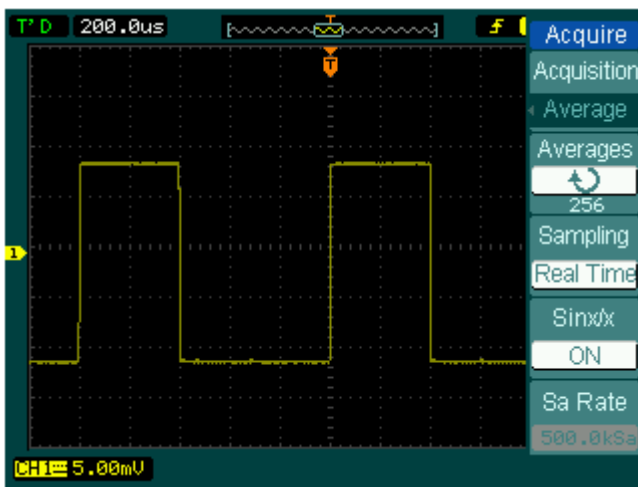

Figure 3-3 Signal without noises

- (2) To reduce the noise it can also be achieved by reducing the intensity of the display.

NOTE: It is normal that the refresh rate will slow down when the average acquisition mode is ON.

Example 5: Making Cursor Measurements

There are 22 build-in automatic measurements. They can also be conducted using cursors to make time and voltage measurements of a waveform quickly.

Measure the Peak Frequency of the First Sinc Waveform

To measure the rising frequency at the rising edge of a signal, do these steps:

1. Press **Cursor** key to see the Cursor menu.
2. Press **Mode** to set **Manual** mode.
3. Press **Type** to select **X**.
4. Turn (↻) knob to place cursor A on the first peak of the wave.
5. Turn (↻) knob to place cursor B on the second peak of the wave.

Observe the data in time and frequency displayed on the screen.

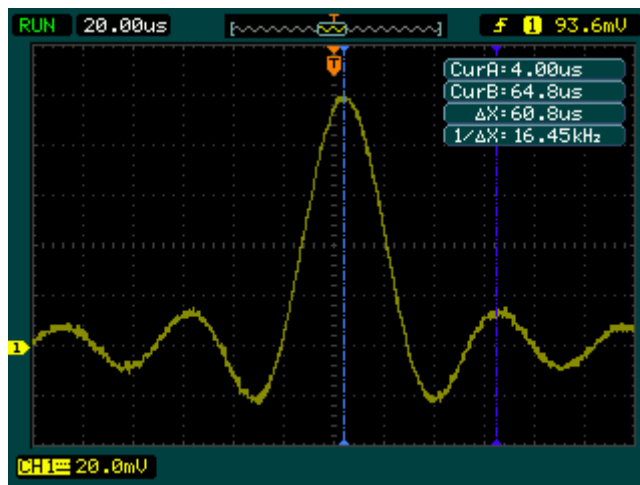

Figure 3-4 Waveform display

Measure the Amplitude of the First Waveform Peak of the Sinc.

Please follow these steps:

1. Press **Cursor** key to see the Cursor menu.
2. Press **Mode** to set **Manual** mode.
3. Press **Type** to select **Y**.
4. Turn (↻) knob to place cursor A on the first peak of the wave.
5. Turn (↻) knob to place cursor B on the second peak of the wave.

Observe the following measurements in the cursor menu: (See Figure 3-5)

- The delta voltage (peak-to-peak voltage of the waveform)
- The voltage at Cursor A
- The voltage at Cursor B

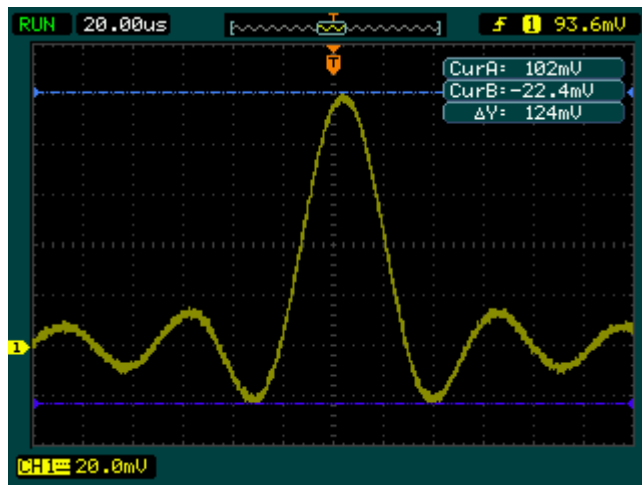

Figure 3-5 Waveform display

Example 6: The Application of the X-Y operation

Viewing Phase Changes through a Network

Theme: Connect the oscilloscope to monitor the input and output of the circuit and capture the phase changes.

To view the input and output of the circuit in an X-Y display, do these steps:

1. From the probe menu set the attenuation to 10X. Set the switch to 10X on the probes.
2. Connect the CH 1 probe to the input of the network, and connect the CH 2 probe to the output.
3. If the channels are not displayed, press the **CH1** and **CH2** buttons.
4. Press the **AUTO** button.
5. Adjust the vertical **SCALE** knob to display approximately the same amplitude signals on each channel.
6. Press the **MENU** in horizontal control area to display the menu.
7. Press the **Time Base** soft button to select **X-Y**.

The oscilloscope displays a luscious pattern representing the input and output characteristics of the circuit.

8. Adjust the vertical **SCALE** and **POSITION** knobs to a desirable waveform display.
9. Apply the Ellipse method to observe the phase difference between the two channels. (See Figure 3-6)

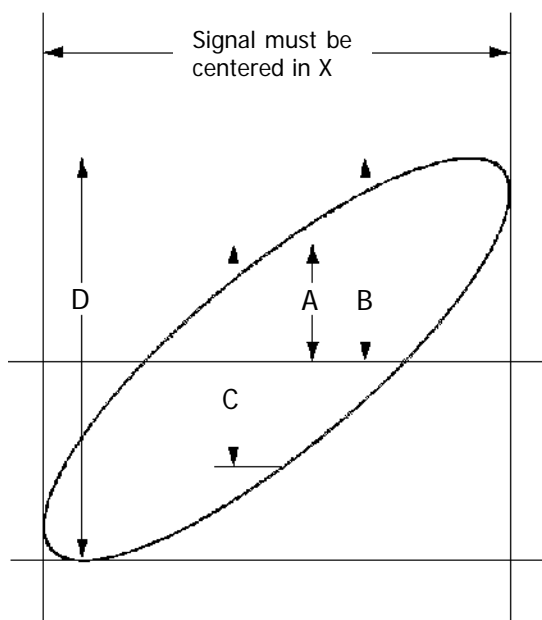

Figure 3-6
Ellipse method to observe the phase difference

$\sin\theta = A/B$ or C/D , where θ = phase shift (in degrees) between the two signals.
From the formula above, you could get:

$$\theta = \pm \arcsine (A/B) \text{ or } \pm \arcsine (C/D)$$

θ must be in the range of $(0 \sim \pi/2)$ or $(3\pi/2 \sim 2\pi)$ if the main axis of the ellipse is at I and III quadrant, If the main axis is at II and IV quadrant, θ must be in the range of $(\pi/2 \sim \pi)$ or $(\pi \sim 3\pi/2)$.

Example 7: Triggering on a Video Signal

Test a video circuit in the DVD set. Use video trigger to obtain a stable display.

Triggering on Video Fields

To trigger on the video fields, please do as the following steps:

1. Press the **MENU** key in the Trigger control area to see the Trigger menu.
2. Press **Mode** to select **Video**.
3. Press **Source** to select **CH1** as trigger source.
4. Press **Polarity** to select **↓**.
5. Press **Sync** as **Odd Field** or **Even Field**.
6. Adjust the **LEVEL** knob to set trigger level at the video sync pulse to get stable trigger.
7. Turn the horizontal **SCALE** knob to see a complete waveform on the screen.

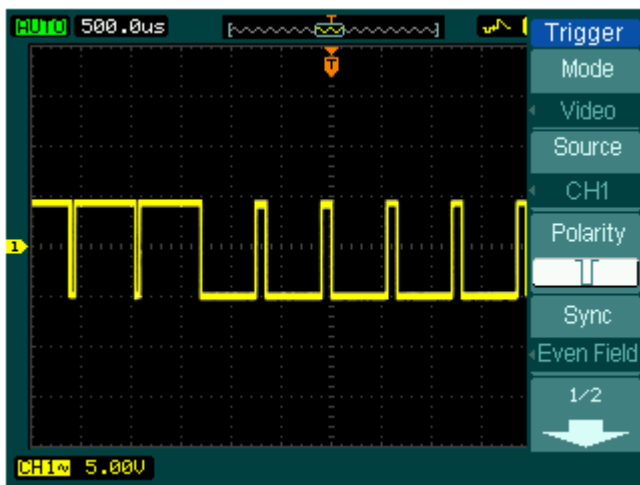

Figure 3-7 Triggering on Video Fields

DS1000B series triggers on the Odd field or Even field. To avoid confusion when Odd field and Even field trigger simultaneously, choose Odd field or Even field as step 5 above.

Triggering on the Video Lines

1. Press the **MENU** key in the Trigger control area to see the trigger menu.
2. Press **Mode** to select **Video**.
3. Press **Source** to select **CH1** as trigger source.
4. Press **Polarity** to select **↓**.
5. Press **Sync** to select **Line Num**.
6. Turn (↻) knob to trigger on a specified line number.
7. Adjust **LEVEL** to set trigger level at the video sync pulse to get a stable trigger.
8. Turn the horizontal **SCALE** knob to observe a complete waveform on the screen.

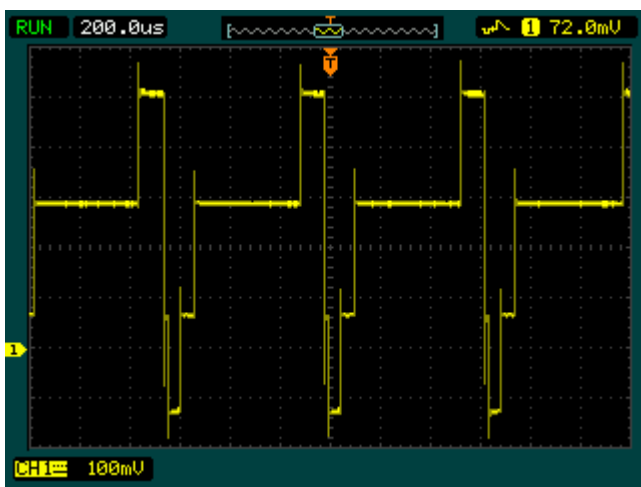

Figure 3-8 Triggering on the Video Lines

Example 8: FFT Cursor Measurement

FFT measurements include: Amplitude measurement (V_{RMS} or dBV_{RMS}) and Frequency measurement (Hz).

Do these steps as follows:

1. Press **Cursor** → Press No.1 button to set cursor mode to **Manual**.
2. Press No.2 button associated with **Type** to select **X** or **Y**.
3. Press button **MATH** → set operate mode as **FFT**.
4. Press **Cursor** → press No.3 button to specify source as **MATH**.
5. Turn (↻) knob to move the cursor A and cursor B to a point of interest.

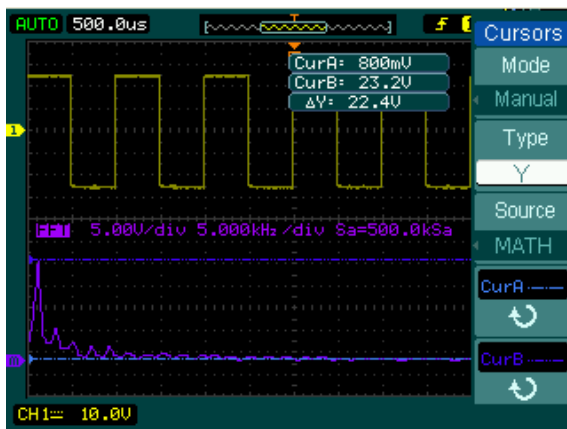

Figure 3-9 Cursor Measurement (Type Y)

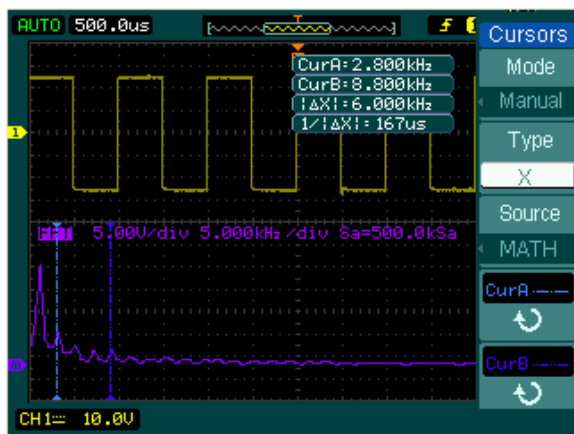



Figure 3-10 Cursor Measurement (Type X)

Example 9: Pass/Fail Test

In Pass/Fail Test, the oscilloscope compares the input signal to the established waveform mask.

Execute the steps as following:

1. Press **Utility** → **Pass/Fail**.
2. Press **Enable Test** and select **ON**.
3. Press **Mask Setting** and then:
Press **Recall** to a the saved mask or press **X Mask** and **Y Mask** to adjust the horizontal limit and vertical limit with the multifunctional knob  then press **Create Mask** to create a new mask.
4. Press **Output** to select the output condition: pass or fail and whether sound is included.
5. Press **Operate** to start the test.
6. Press **Msg Display** and select "ON" or "OFF". When "ON" is selected, the test results would be displayed at the upper left corner of the screen.

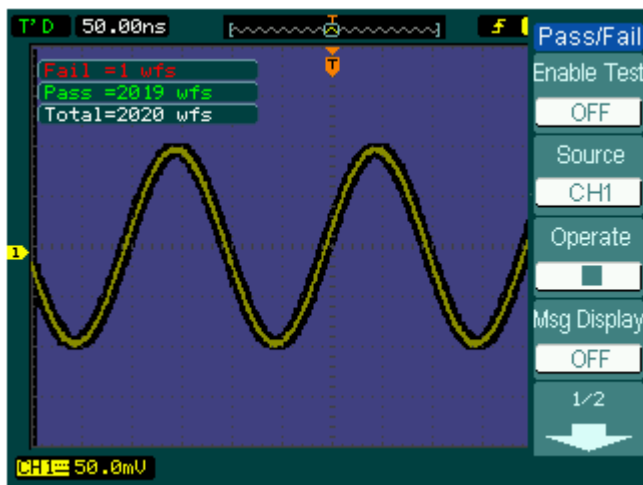

Figure 3-11 Waveform display

Chapter 4 Troubleshooting

1. After the oscilloscope is powered on, the screen remains dark (no display):

- (1) Check the power cord connection.
- (2) Ensure the power switch is turned on.
- (3) Check whether the fuse burns out or not.
- (4) After the above inspection, restart the oscilloscope.
- (5) If the problem still remains, please contact **RIGOL** for help.

2. After the signal acquisition the waveform does not appear:

- (1) Check the probes connected with the signals.
- (2) Check the probes connected to the channels firmly.
- (3) Check the probes connected with the object being tested.
- (4) Check the circuit generates signal at the test point (To judge whether channel or determinand in question, you can input the probe compensation output signal to a channel in question).
- (5) Repeat the acquisition.

3. The measurement result is 10 times higher or lower than the value expected.

Check if the probe attenuation is the same as the channel attenuation.

4. If the oscilloscope does not get a stable waveform display:

- (1) Check the Trigger Source and notice if it is set to the channel in use.
- (2) Check the Trigger Type. Use "Edge" for normal signals, and use "Video" for VIDEO signals.
- (3) Switch the coupling into **LF Reject** in order to filter out the low frequency noise which disturbs the trigger or press **HF Reject** and select "ON" to filter out the high frequency noise that disturbs the trigger.
- (4) Adjust the trigger **Sensitivity** and the **holdoff** time.

5. After pressing the **Run/Stop** button, the oscilloscope does not display any waveform on screen.

Check whether the **Trigger Mode** is set to "Normal" or "Single" and see whether the trigger level is out of the signal range. If yes, set the trigger level in proper range by turning the **LEVEL** knob or pressing the **50%** button. Or set

the Trigger Mode as "AUTO". Moreover, push **Auto** button to display the waveform on screen.

6. After the Acquisition is set to "Averages" or Display Persistence is set ON, the waveform refreshes slowly.

It is normal in these settings.

7. The signal is displayed as ladder like waveform.

- (1) The time base setting maybe is too low. Turn the horizontal **SCALE** knob to increase horizontal resolution to improve the display.
- (2) Maybe the display **Type** is set to **Vectors**, and set it to **Dots** mode to improve the display.

8. Unable to connect to PC or the PictBridge printer by USB:

- (1) When connected to PC, if the message "Unknown device" appears or prompting scanner or camera was found. Press **Utility** to choose the **I/O Setting** menu, you may see the **USB Device** menu has been set to be "PictBridge", you should switch it to "Auto Detect" or "Computer". If necessary, restart the oscilloscope.
- (2) If connecting to a PictBridge printer or the printing is unsuccessful, maybe the **USB Device** menu has been set to "Computer". You should switch it to be "Auto Detect" or "PictBridge". If necessary, restart the oscilloscope.

Chapter 5 Specifications

All specifications apply to the DS1000B Series Oscilloscopes unless noted otherwise. To meet these specifications, two conditions must first be met:

- The instrument must have been operating continuously for thirty minutes within the specified operating temperature.
- Must perform the Self Cal operation, accessible through the Utility menu, if the operating temperature changes by more than 5°C.

NOTE:

- All specifications are guaranteed unless noted "typical".

Technical Specifications

Acquisition		
Sampling Modes	Real-Time	Equivalent-time
Sampling Rate	2 GSa/s (half channel ^[1]) 1 GSa/s (each channel)	50 GSa/s ^[2]
Averages	N time acquisitions, all channels simultaneously, N is selectable from 2, 4, 8, 16, 32, 64, 128 and 256	

Inputs	
Input Coupling	DC, AC, GND
Input Impedance	1M Ω \pm 2.0% The input capacity is 18pF \pm 3pF
Probe Attenuation Factors	0.001X, 0.01X, 0.1X, 1X, 2X, 5X, 10X, 20X, 50X, 100X, 200X, 500X, 1000X
Maximum Input Voltage	Maximum Input Voltage of the analog channel: CAT I 300Vrms, 1000Vpk; transient overvoltage 1000Vpk CAT II 100Vrms, 1000Vpk RP2200 10:1, CAT II 300Vrms RP3200 10:1, CAT II 300Vrms RP3300 10:1, CAT II 300Vrms
Time delay between channel (typical)	500ps



Horizontal	
Sample Rate Range	3.65Sa/s-2GSa/s (Real-Time), 3.65Sa/s-50GSa/s (Equivalent-time)
Waveform interpolation	Sin(x)/x
Memory Depth	16k samples when horizontal timebase is 20ns/div or lower and 8k samples when horizontal timebase is 50ns/div or higher for half channel ^[1] 8k samples for each channel
Scan speed Range (Sec/div)	1ns/div~50s/div, DS1204B 2ns/div~50s/div, DS1104B 5ns/div~50s/div, DS1074B

	1-2-5 Sequence
Sample Rate and Delay Time Accuracy	$\pm 50\text{ppm}$ (over any $\geq 1\text{ms}$ time interval)
Delta Time Measurement Accuracy (Full Bandwidth)	Single-shot: $\pm(1 \text{ sample interval} + 50\text{ppm} \times \text{reading} + 0.6 \text{ ns})$ > 16 averages: $\pm(1 \text{ sample interval} + 50\text{ppm} \times \text{reading} + 0.4 \text{ ns})$

Vertical	
A/D converter	8-bit resolution, each channel samples simultaneously
Volts/div Range	2mV/div-10V/div at input BNC
Offset Range	$\pm 40\text{V}$ (250mV/div ~ 10V/div) $\pm 2\text{V}$ (2mV/div ~ 245mV/div)
Analog Bandwidth	70MHz(DS1074B) 100MHz(DS1104B) 200MHz(DS1204B)
Single-shot Bandwidth	70MHz(DS1074B) 100MHz(DS1104B) 200MHz(DS1204B)
Selectable Analog Bandwidth Limit	20MHz (typical)
Lower Frequency Limit (AC -3dB)	$\leq 5\text{Hz}$ (at input BNC)
Rise Time at BNC, typical	<1.75ns, <3.5ns, <5ns, On 200MHz, 100MHz, 70MHz respectively
Dynamic range	$\pm 5\text{div}$
DC Gain Accuracy	2mV/div~5mV/div: $\pm 4\%$ (Normal or Average acquisition mode) 10mV/div~10V/div: $\pm 3\%$ (Normal or Average acquisition mode)
DC Measurement Accuracy, Average Acquisition Mode	Average of ≥ 16 Waveforms with vertical position at zero: $\pm(\text{DC Gain Accuracy} \times \text{reading} + 0.1\text{div} + 1\text{mV})$ Average of ≥ 16 Waveforms with vertical position not at zero: $\pm[\text{DC Gain Accuracy} \times (\text{reading} + \text{vertical position}) + (1\% \text{ of vertical position}) + 0.2\text{div}]$ Add 2mV for settings from 2mV/div to 245 mV/div

RIGOL

	Add 50mV for settings from 250mV/div to 10V/div
Delta Volts Measurement Accuracy (Average Acquisition Mode)	Delta Volts between any two averages of 16 waveforms acquired under same setup and ambient conditions: $\pm(\text{DC Gain Accuracy} \times \text{reading} + 0.05 \text{ div})$

Trigger	
Trigger Sensitivity	0.1div-1.0div (adjustable)
Trigger Level Range	Internal ± 6 divisions from center of screen
	EXT $\pm 1.2\text{V}$
	EXT/5 $\pm 6\text{V}$
Trigger Level Accuracy (typical) applicable for the signal of rising and falling time $\geq 20\text{ns}$	Internal $\pm(0.3\text{div} \times \text{V/div})(\pm 4$ divisions from center of screen)
	EXT $\pm(6\%$ of setting + 40 mV)
	EXT/5 $\pm(6\%$ of setting + 200 mV)
Trigger Offset	Normal mode: pre-trigger(storage depth/(2 \times sampling) rate), delayed trigger 1s
	Slow Scan mode: pre-trigger 6div, delayed trigger 6div
Trigger Holdoff range	100ns~1.5s
HF Rejection	100kHz $\pm 20\%$
LF Rejection	10kHz $\pm 20\%$
Set Level to 50% (typical)	Input signal frequency $\geq 50\text{Hz}$
Edge Trigger	
Edge trigger slope	Rising, Falling, Rising + Falling
Pulse Trigger	
Trigger condition	(>, <, =) Positive pulse, (>, <, =) negative pulse
Pulse Width range	20ns ~10s
Video Trigger	
Video standard & line frequency	Support standard NTSC, PAL and SECAM broadcast systems. Line number range: 1~525 (NTSC) and 1~625 (PAL/SECAM)
Pattern Trigger	
Pattern setup	H, L, X,  , 
Alternate Trigger	

Trigger on CH1, CH2, CH3, CH4	Edge, Pulse, Video
----------------------------------	--------------------

Measurements		
Cursor	Manual	Voltage difference between cursors (ΔV) Time difference between cursors (ΔT) Reciprocal of ΔT in Hertz ($1/\Delta T$)
	Track	Voltage value for Y-axis waveform Time value for X-axis waveform
	Auto	Cursors are visible for Automatic Measurement
Auto Measure	Vpp, Vamp, Vmax, Vmin, Vtop, Vbase, Vavg, Vrms, Overshoot, Preshoot, Freq, Period, Rise Time, Fall Time, +Width, -Width, +Duty, -Duty, Delay A→B \bar{f} , Delay A→B \bar{t} , Phase A→B \bar{f} , Phase A→B \bar{t}	

NOTE:

[1] Half channel indicates selecting one of the channels in CH1 and CH2, or in CH3 and CH4.

[2] This is the highest specification, the specific specifications are as follows:

DS1204B: 50GSa/s

DS1104B: 25GSa/s

DS1074B: 10GSa/s

General Specifications

Display		
Display Type	5.7 inch. (145 mm) diagonal TFT Liquid Crystal Display	
Display Resolution	320 horizontal ×RGB×240 vertical pixels	
Display Color	64k color	
Display Contrast (typical)	150:1	
Backlight Brightness (typical)	300 nit	
Probe Compensator Output		
Output Voltage (typical)	Approximately 3Vpp (peak to peak value)	
Frequency (typical)	1kHz	
Power		
Supply Voltage	AC, 100~240 V, 45~440Hz, CAT II	
Power Consumption	Less than 50W	
Fuse	2A, T rating, 250 V	
Environmental		
Ambient Temperature	Operating 10°C ~ 40°C	
	Non-operating -20°C ~ +60°C	
Cooling Method	Fan force air flow	
Humidity	+35°C or below: ≤90% relative humidity	
	+35°C ~ +40°C: ≤60% relative humidity	
Altitude	Operating 3,000 m or below	
	Non-operating 15,000 m or below	
Mechanical		
Size	Width	325mm
	Height	159mm
	Depth	133 mm
Heavy	Without package	3kg
	Packaged	4.3 kg
IP Protection		
IP2X		
Calibration Interval		
The recommended calibration interval is one year		

Chapter 6 Appendixes

Appendix A: DS1000B series Accessories

Standard Accessories

- Probe×4 , 1:1 (10:1) Passive Probes
When the switch of probe is toggled to 1X attenuation setting, the probe has 6MHz bandwidth, according with 150V CAT II.
When the switch of probe is set to 10X attenuation setting ,the probe's bandwidth equals to the upper limit of the oscilloscope, according with 300V CAT II.
- A Power Cord that fits the standard of destination country.
- An USB Cable
- A CD-ROM (including User's Guide an application software)
- A Quick Guide

Optional Accessories:

- BNC Cable
- USB-GPIB Adapter
- 50Ω Impedance Adapter
- DS1000B special convenient soft bag

All accessories (standard and optional) are available by contacting your local RIGOL office.

Appendix B: Warranty

RIGOL warrants its products' mainframe and accessories in materials and workmanship within the warranty period. During the period concerned, **RIGOL** guarantees the free replacement or repair of products which are approved defective.

To get repair service or obtain a copy of the whole warranty statement, please contact with your nearest **RIGOL** sales and service office.

RIGOL do not provide any other warranty items except the one being provided by this summary and the warranty statement. The warranty items include but not being subjected to the hint guarantee items related to tradable characteristic and any particular purpose. **RIGOL** will not take any responsibility in cases regarding to indirect, particular and ensuing damage.

Appendix C: General Care and Cleaning

Do not store or leave the instrument in where the instrument will be exposed to direct sunlight for long periods of time.

Caution

To avoid damages to the instrument or probes, do not expose them to liquids which have causticity.

Cleaning

Clean the instrument and probes according to its operating conditions require. To clean the exterior surface, perform the following steps:

1. Disconnect the instrument from all power sources.
2. Clean the loose dust on the outside of the instrument and probes with a lint-free cloth (with a mild detergent and water). When clean the LCD, take care to avoid scarifying it.



WARNING

To avoid injury resulting from short circuit, make sure the instrument is completely dry before reconnecting into a power source.

Index

50%.....	1-16	Hanning Window.....	2-18
AC Coupling.....	2-6	HF Reject.....	2-46
AC Line.....	2-45	Horizontal.....	5-2
Accessories.....	6-2	I/O setup.....	2-66
Acquire.....	2-48	Inputs.....	5-2
Acquisition.....	5-2	Instant Execute Key.....	2-105
Alternative Trigger.....	2-39	Invert a waveform.....	2-13
Appendix.....	6-1	Language.....	2-74
AUTO.....	2-106	LF Reject.....	2-46
Auto Trigger.....	2-45	Measurements.....	5-4
Automatic Measurement.....	2-90	Normal Trigger.....	2-46
Average Acquisition.....	2-51	Nyquist Frequency.....	2-19
Bandwidth Limit.....	2-8	PictBridge.....	2-78
Blackman Window.....	2-18	Power.....	5-6
Channel Coupling.....	2-6	Pretrigger.....	2-46
Cleaning.....	6-3	Probe Attenuation.....	2-9
Coarse/Fine.....	1-12	Probe compensation.....	1-9
Cursor.....	2-99	Probe Compensator.....	5-6
Cursor Measurements.....	2-99	Pulse Trigger.....	2-34
DC Coupling.....	2-6	Random Noise.....	3-4
Display.....	5-6	Realtime Sampling.....	2-51
Display System.....	2-52	Rectangle Window.....	2-18
Edge Trigger.....	2-33	REF.....	2-20
Envelope.....	2-51	RUN/STOP.....	2-105
Equivalent Sampling.....	2-51	Sampling System.....	2-48
Ext and Ext/5.....	2-45	Save and Recal.....	2-55
Factory Setup.....	2-63	Self- Calibration.....	2-86
FFT.....	2-16	Single Trigger.....	2-46
FORCE.....	1-16	Slope Trigger.....	2-37
Front panel.....	1-3	Sync Pulses.....	2-36
Functional check.....	1-7	Trigger.....	5-4
GND Coupling.....	2-7	Trigger Control.....	1-15
Hamming Window.....	2-18	Trigger System.....	2-32

RIGOL

UTILITY.....	2-64	Vertical Window	1-11
Vertical.....	5-3	Video Signal.....	3-10
Vertical System	2-2	Video Trigger	2-35