User's Guide

RIGOL

Publication Number: UGC03120-1110

Feb. 2014

DM3058/DM3058E Digital Multimeter

Copyright Information

1. © 2008 RIGOL Technologies, Inc. All Rights Reserved.
2. **RIGOL** products are protected by patent law in and outside of P.R.C..
3. Information in this publication replaces all previously corresponding material.
4. RIGOL Technologies, Inc. reserves the right to modify or change part of or all the specifications and pricing policies at company's sole decision.

NOTE: RIGOL is registered trademark of RIGOL Technologies, Inc

Safety Notices

Review the following safety precautions carefully before operating the instrument to avoid any personal injuries or damages to the instrument and any products connected to it. To avoid potential hazards use the instrument as specified by this user's guide only.

The instrument should be serviced by qualified personnel only.

Avoid Fire or Personal Injury.

Use Proper Power Cord.

Only the power cord designed for the instrument as authorized in your country could be used.

Ground The Instrument.

The instrument is grounded through the grounding conductor of the power cord. To avoid electric shock the instrument grounding conductor(s) must be grounded properly before making connections to the input or output terminals of the instrument.

Observe All Terminal Ratings.

To avoid fire or shock hazard, observe all ratings and marks on the instrument. Follow the user's guide for further ratings information before making connections to the instrument.

Do Not Operate Without Covers.

Do not operate the instrument with covers or panels removed.

Use Proper Fuse.

Please use the fuse that its voltage and current ratings as specified for the instrument.

Avoid Circuit or Wire Exposure.

Do not touch exposed connections and components when power is on.

Do Not Operate With Suspected Failures.

If suspected damage occurs with the instrument, have it inspected by qualified service personnel before further operations.

Keep Well Ventilated.

Do Not Operate in Wet/Damp Conditions.

Do Not Operate in an Explosive atmosphere.

Keep Product Surfaces Clean and Dry.

The disturbance test of all the models meet the P/F values of A in the standard of EN 61326: 1997+A1+A2+A3, but can't meet the P/F values of B.

Input Terminal Protection Limitation

Protection limitation is defined for the input terminal:

1. Main input (HI and LO) terminal

HI and **LO** terminals are used for Voltage, Resistance, Capacitance, Continuity, Frequency and Diodes measurement. Two protection limitations are defined:

- 1) **HI-LO** protection limitation: 1000 VDC or 750 VAC. It is the maximum measurable voltage. The limitation can be expressed as 1000 Vpk.
- 2) **LO-ground** protection limitation. **LO** terminal can safely "float" 500 Vpk relative to the ground.

The maximum protection limitation of HI terminal relative to the ground is 1000 Vpk. Therefore, the sum of the "float" voltage and the measured voltage cannot exceed 1000 Vpk.

2. Sampling (HI Sense and LO Sense) terminal

HI Sense and **LO Sense** are used for 4-Wire Resistance Measurement. Two protection limitations are defined:

- 1) **HI Sense-LO Sense** protection limitation: 200Vpk.
- 2) **LO Sense-LO** protection limitation: 2Vpk.

3. Current input (I) terminal

I and **LO** terminal are used for current measurement. The maximum current which go through the **I** terminal is limited to 10A by the fuse on the rear panel.

NOTE: Voltage on the current input terminal corresponds to voltage on **LO** terminal. To obtain favorable protection, specified fuse should be used.

IEC Measurement Category II Overvoltage Protection

To protect against the danger of electric shock, DM3058/DM3058E provides overvoltage protection for line-voltage mains connections meeting both of the following conditions:

1. The HI and LO input terminals are connected to the mains under Measurement Category II conditions, defined below.
2. The mains are limited to a maximum line voltage of 600 VAC.

WARNING: IEC Measurement Category II includes electrical devices connected to mains at an outlet on a branch circuit. Such devices include most small appliances, test equipment, and other devices that plug into a branch outlet or socket.

DM3058/DM3058E may be used to make measurements with the HI and LO inputs connected to mains in such devices (up to 600 VAC), or to the branch outlet itself. However, DM3058/DM3058E may not be used with its HI and LO inputs connected to mains in permanently installed electrical devices such as the main circuit-breaker panel, sub-panel disconnected boxes, or permanently wired motors. Such devices and circuits are subject to overvoltage that may exceed the protection limits of DM3058/DM3058E.

NOTE: Voltages above 600 VAC may be measured only in circuits that are isolated from mains. However, transient overvoltage is also present on circuits that are isolated from mains. DM3058/DM3058E is designed to safely withstand occasional transient overvoltage up to 4000Vpk. Do not use this equipment to measure circuits where transient overvoltage could exceed this level.

Safety Terms and Symbols

Terms in this Manual. These terms may appear in this manual:



WARNING: Warning statements indicate the conditions or practices that could result in injury or loss of life.



CAUTION: Caution statements indicate the conditions or practices that could result in damage to this product or other property.



CAT I (1000V) IEC Measurement Category I. The maximum voltage can be measured by HI-LO terminal is 1000Vpk.



CAT II (600V): IEC Measurement Category II. Inputs may be connected to mains (up to 600VAC) under Category II over voltage conditions.

Terms on the Product. These terms may appear on the product:

DANGER indicates an injury or hazard may immediately happen.
WARNING indicates an injury or hazard may be accessible potentially.
CAUTION indicates a potential damage to the instrument or other property might occur.

Symbols on the Product. These symbols may appear on the product:



Hazardous Voltage



Safety Warning



Protective Earth Terminal



Chassis Ground



Test Ground

DM3058/DM3058E Overview

RIGOL DM3058/DM3058E is a 5½ dual-display instrument especially designed for high-precision, multifunction, and automation measurements. It realized a combination of basic measurement functions and math functions as well as sensor measurement function.

The DM3058/DM3058E holds a 256 x 64 lattice high-resolution monochrome LCD display screen with clear keyboard layout and operation hints to make it easier and agility to use. Besides, it supports multi-interface such as RS-232, USB, LAN (only for DM3058) and GPIB (only for DM3058).

Main Features:

- Real 5½ digits resolution.
- Three measurement speeds: 2.5 reading/s, 20 reading/s and 123 reading/s.
- Double Display function enables to display two types of characteristic for one signal synchronously.
- Two operation modes: Preset and Ordinary. Preset mode is able to store configuration quickly.
- DC Voltage Range between 200mV and 1000V.
- DC Current Range between 200μA and 10A.
- True-RMS, AC Voltage Range between 200mV and 750V.
- True-RMS, AC Voltage Current between 20mA and 10A.
- Resistance Range between 200Ω and 100MΩ for 2&4-Wire Resistance Measurement.
- Capacitance Range between 2nF and 10000μF.
- Frequency Range between 20Hz and 1MHz.
- Continuity and Diode Test.
- Sensor Measurement function, Built-in Thermocouple compensate in Cold Terminal.
- Abundant Math operations: Max, Min, Average, P/F, dBm, dB, Relative Measurement, Standard Deviation and Histogram.
- Support the storage of data and configuration via USB flash device.
- Support USB, GPIB (only for DM3058), RS-232 and LAN (only for DM3058) interfaces. Support USB-TMC, IEEE 488.2 standard, LXI-C class standard (only for DM3058) and SCPI language.
- In possession of compatible commands with both Agilent 34401A and Fluke

45.

- Record and save the history measurement results.
- Three kinds of management for Power Supply: PwrOn, Default and Switch.
- Enable to store 10 groups of system configurations in the internal memory and recall them when required.
- Backup or "Clone" all the configurations within instrument into other DM3058/DM3058E via USB flash device.
- Chinese and English menu and online help system.
- Provides with control software on PC and application software for sensor.

Document Overview

Chapt 1 Quick Start

Guide you to prepare your DM3058/DM3058E and know about the Front/Rear Panel and User interface.

Chapt 2 Panel Operation

Introduce you how to operate DM3058/DM3058E via Front Panel.

Chapt 3 Application Examples

Introduce you how to use strong measurement functions of this instrument easily through examples.

Chapt 4 Troubleshooting

Provide you some general troubleshooting.

Chapt 5 Measurement Tutorial

Guide you to eliminate the errors that may appear during your measurement and obtain accurate result.

Chapt 6 Characteristics

List specifications and characteristics.

Chapt 7 Appendix

Information about accessories, warranties, services and supports and the like.

Contents

DM3058/DM3058E Overview.....	VI
Chapter 1 Quick Start.....	1-1
General Inspection.....	1-2
Handle Adjustment	1-3
The Front Panel.....	1-4
The Rear Panel.....	1-5
Power On.....	1-6
User Interface	1-7
Double Display	1-7
Single Display.....	1-7
Chapter 2 Front Panel Operation.....	2-1
To Select Range.....	2-2
To Select Measurement Rate.....	2-4
Basic Measurement Functions	2-5
To Measure DC Voltage	2-6
To Measure AC Voltage.....	2-9
To Measure DC Current	2-11
To Measure AC Current.....	2-13
To Measure Resistance	2-15
To Measure Capacitance	2-20
To Test Continuity	2-22
To Check Diode	2-24
To Measure Frequency and Period	2-25
Any Sensor Measurement	2-29
Preset.....	2-37
Secondary Function	2-38
To Control Trigger Options	2-40
To Set up Measurement Parameters	2-41
Math Functions.....	2-44
Statistic Measurement	2-45
P/F Measurement	2-46
dBm Measurement.....	2-48
dB Measurement	2-49
Relative Operation	2-50

To Set Up Trigger Parameters.....	2-51
Auto Triggering.....	2-52
Single Triggering.....	2-54
External Triggering.....	2-55
Store and Recall	2-57
To Set Up the Utility.....	2-60
Commands.....	2-61
I/O Settings	2-62
System Settings.....	2-67
Test/Cal	2-72
Print	2-73
How to Use the Built-in Help System.....	2-74
Chapter 3 Application Examples	3-1
Example 1: Reading Statistic Functions	3-2
Example 2: Elimination Leads Impedance.....	3-3
Example 3: dBm Measurement.....	3-4
Example 4: dB Measurement	3-5
Example 5: P/F Test	3-6
Example 6: Thermocouple Setting and Measurement	3-7
Example 7: Reading Hold	3-11
Example 8: Store and Recall the Preset.....	3-12
Example 9: Mirror Image Configuration.....	3-13
Example 10: To Realize Remote Control via LXI (only for DM3058)	3-15
Chapter 4 Troubleshooting	4-1
Chapter 5 Measurement Tutorial	5-1
True RMS AC Measurements.....	5-1
Crest Factor Errors (non-sinusoidal inputs).....	5-3
Loading Errors (AC Volts)	5-4
Application of the Analog Filter.....	5-5
Chapter 6 Characteristics.....	6-1
General Technical Characteristics.....	6-1
Electric Technique Characteristics	6-2
DC Characteristics.....	6-2
AC Characteristics	6-4
Frequency/Period Characteristics	6-7
Capacitance Characteristics.....	6-8

Other Measurement Characteristics	6-9
Chapter 7 Appendix.....	7-1
Appendix A: DM3058/DM3058E Accessories	7-1
Appendix B: Warranty	7-2
Appendix C: General Care and Cleaning	7-3
Appendix D: Contact Us	7-4

Chapter 1 Quick Start

- General Inspection
- Handle Adjustment
- The Front Panel
- The Rear Panel
- Power On
- User Interface

General Inspection

1. Inspect the shipping container for damage.

Keep the damaged shipping container or cushioning material until the contents of the shipment have been checked for completeness and the instrument has been checked mechanically and electrically.

2. Check the accessories.

Accessories supplied with the instrument are listed in Appendix A of this guide.

If the contents are incomplete or damaged, please notify the **RIGOL** Sales Representative.

3. Inspect the instrument.

In case of any damage, or defect, or failure, notify the **RIGOL** Sales Representative.

If the shipping container is damaged, or the protective material shows signs of stress, notify the carrier as well as your **RIGOL** sales office. Keep the shipping materials for the carrier's inspection.

RIGOL offices will arrange reparation or replacement at **RIGOL's** option without waiting for claim settlement.

Handle Adjustment

In order to adjust the handle position of the multimeter, please grip the handle in both sides and pull it outward. Then, rotate the handle to the desired position as shown in the figures below.

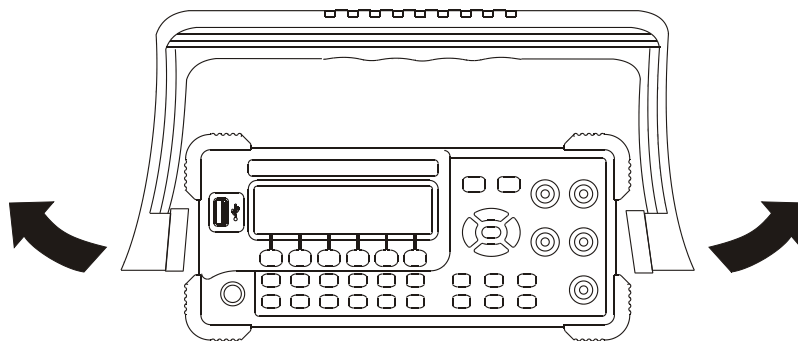

Figure 1-1 Adjust Handle

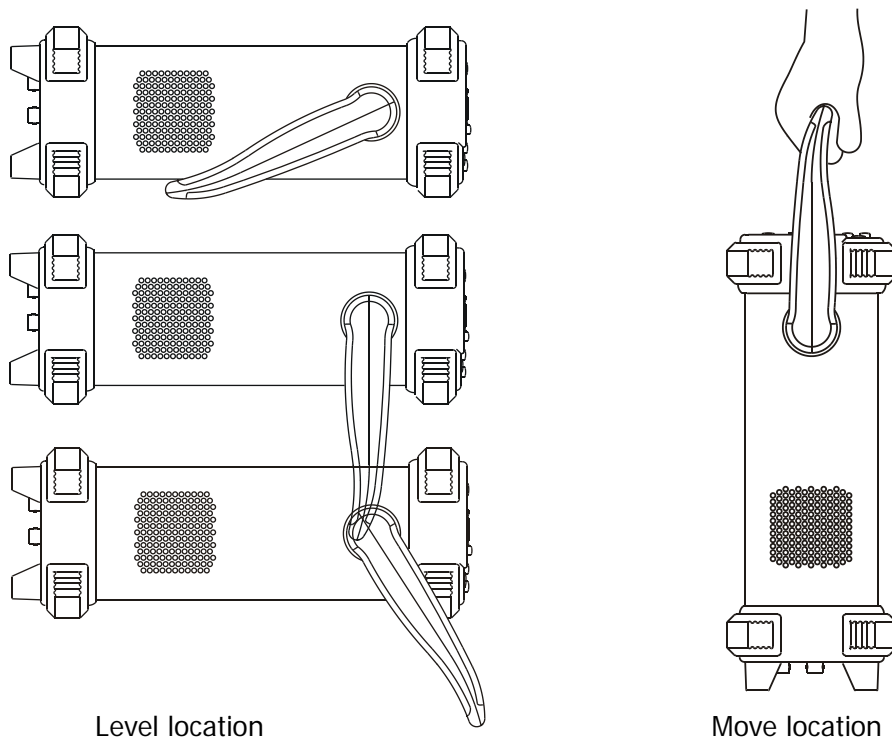

Figure 1-2 Adjustable location of Handle

The Front Panel

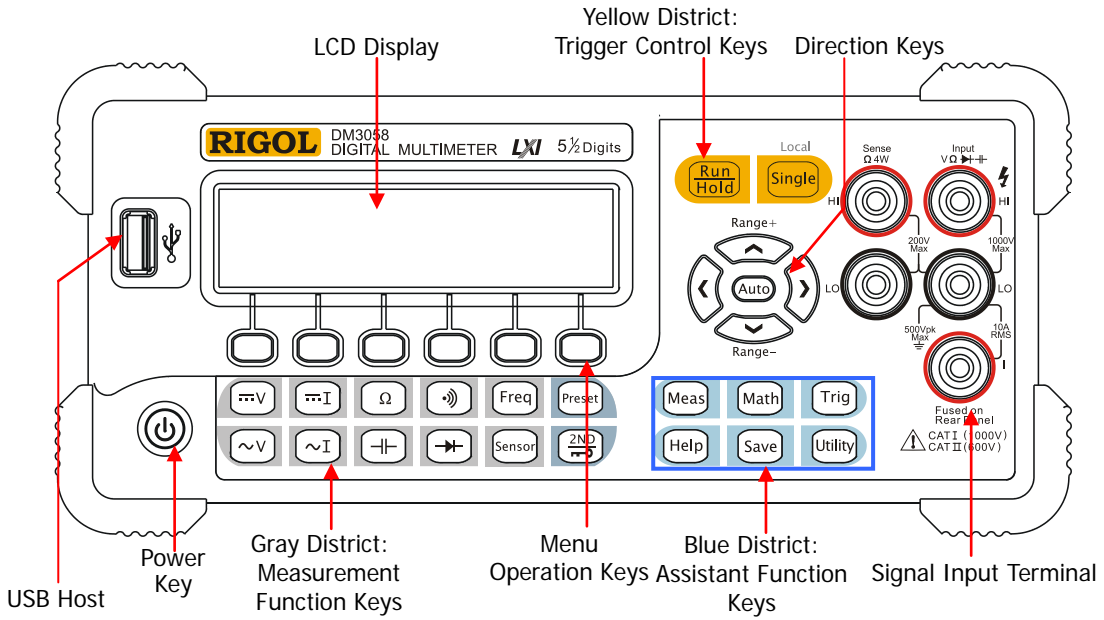

Figure 1-3 Front Panel Overview

The Rear Panel

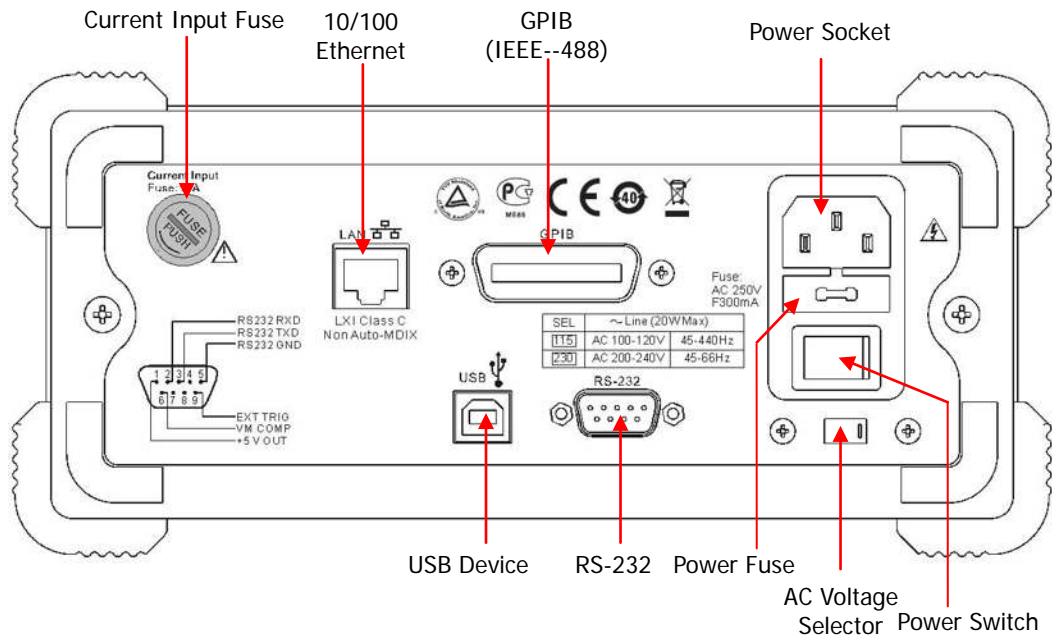







Figure 1-4 Rear Panel Overview

Explanation: DM3058E does not support GPIB and LAN interfaces.

Power On

Power on the instrument according to the following steps:

1. Adjust AC Voltage Selector to "115" (100~120V, 45~440Hz, AC) or "230" (200~240V, 45~60Hz, AC) in accordance with power standards in your country;
2. Connect the instrument to AC supply via power cord supplied by **RIGOL**;
3. Turn on the power switch on the rear panel;
4. Press the power key^[1] on the front panel, the instrument will be started a few seconds later.

Note ^[1]: Press  → ^[2] →  →  →  to disable the power key, so as to start the instrument after turning on the power switch on the rear panel.

Note ^[2]: The characters listed under shading indicate menu in the multimeter.

User Interface

Double Display

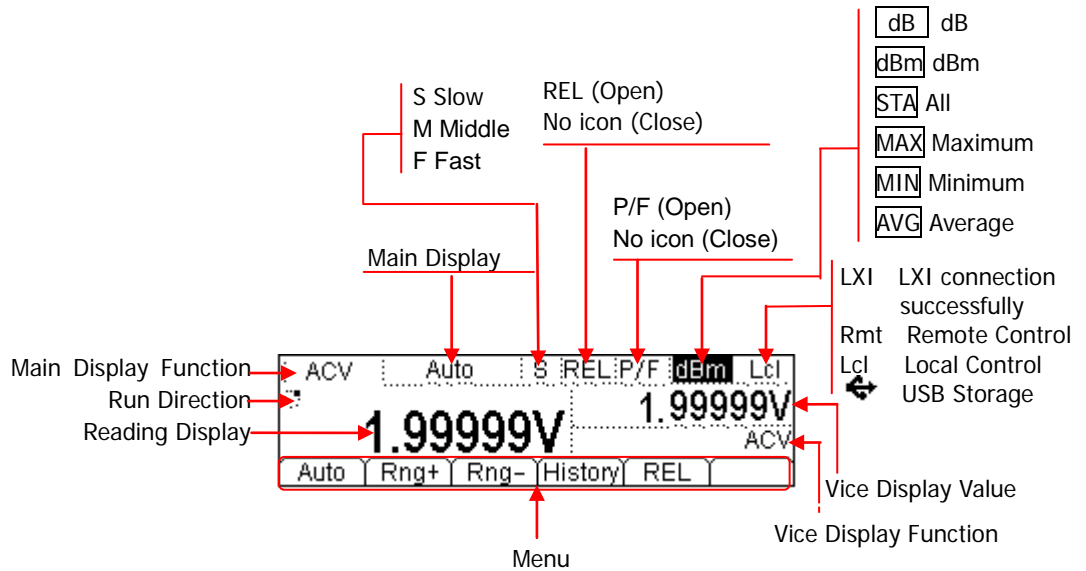

Single Display

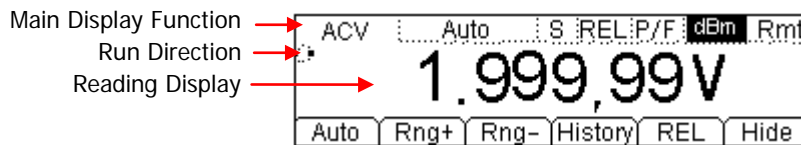



























Figure 1-5 User Interface

Chapter 2 Front Panel Operation

■ To Select Range			
■ To Select Measurement Rate			
■ To Measure DC Voltage			
■ To Measure AC Voltage			
■ To Measure DC Current			
■ To Measure AC Current			
■ To Measure Resistance			
■ To Measure Capacitance			
■ To Test Continuity			
■ To Check Diode			
■ To Measure Frequency and Period			
■ Any Sensor Measurement			
■ Preset			
■ Secondary Function			
■ To Control Trigger Options			
■ To Set up Measurement Parameters			
■ Math Functions			
■ To Set Up Trigger Parameters			
■ Store and Recall			
■ To Set Up the Utility			
■ How to Use the Built-in Help System			

To Select Range

For the multimeter, appropriate range could be selected according to the signals input by "Automatic" or "Manual". In Manual mode, you can obtain higher reading precision via range select keys on the right side of the Front Panel. See the figure below.

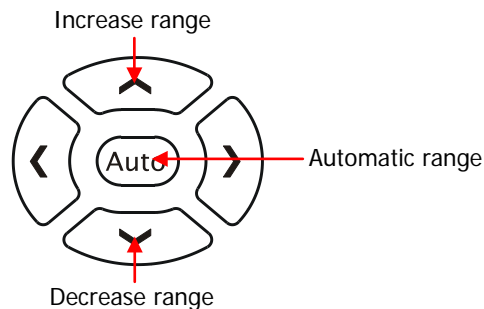

Figure 2-1 Range selection keys

Method 1:

Via Function keys on the Front Panel

Auto Range: Press **Auto** to choose Auto Range, meanwhile Manual Range is forbidden.

Manual Range: Press Up or Down direction keys to increase or decrease range gradually, at this moment, Auto Range is forbidden.

Method 2:

Via soft keys on the Measurement main interface shown in Figure 2-2.

Auto Range: Press **Auto** to choose Auto Range, meanwhile Manual Range is forbidden.

Manual Range: Press **Rng+** or **Rng-** to choose required range manually, at this moment, Auto Range is forbidden.

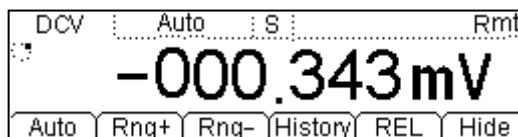

Figure 2-2 Range selection menus

Explanations:

- When the input signal is beyond the current scope of the measurement range, the multimeter will show "OVER LOAD".
- After restarting and remote reset, range options will turn back to default "Auto".
- You are suggested to select "Auto" range so as to protect the instrument against damage and get exact datum as much as possible when it is hard to predict the range of measurement.
- The range is fixed during testing the Continuity and Diodes. The range of Continuity is selected as 2k Ω while the Diodes are 2.4V.

NOTE

Other functions of the direction keys:

- In the Save interface, Up and Down keys are used to select location for the saving files.
- During inputting data, Up and Down keys are used to change the selected value. Each press for the up key, value will be increased 1, vice versa.
- At the input interface of data, Left and Right keys are used to switch the number of a numerical value. Each press for the Left key, former number will be selected, vice versa.

To Select Measurement Rate

The instrument provides three types of measurement rate: 2.5 reading/s, 20 reading/s and 123 reading/s.

2.5 reading/s belongs to "Slow" rate; the mark of Status Bar is "S" and the rate of refurbishing is 2.5Hz.

20 reading/s belongs to "Middle" rate, the mark of Status Bar is "M" and the rate of refurbishing is 20Hz.

123 reading/s belongs to "Fast" rate, the mark of Status Bar is "F" and the rate of refurbishing is 50Hz.

Measurement rate could be controlled by Left and Right direction key. Each press for the Left key, one level will be increased for rate, vice versa.

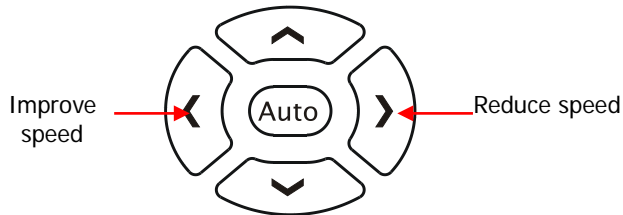

Figure 2-3 Rate selection keys

Explanations

1. Three reading rates are available for DCV, ACV, DCI, AC and OHM.
2. To set as linkage for both reading resolution and reading (measurement) rate.
 - 2.5 reading/s belongs to 5.5 digit resolution.
 - Both 20 reading/s and 123 reading/s belong to 4.5 digit resolution.
 - The reading resolution of Sensor is fixed at 5.5 digit and both "M" and "S" rate can be chosen.
 - The reading resolutions and measurement rates of both Diode and Continuity are fixed at 4.5 digit and "Fast" respectively.
 - The reading resolution and measurement rate of the Freq function are fixed at 5.5 digit and "Slow" respectively.
 - The reading resolution and measurement rate of the Cap function are fixed at 3.5 digit and "Slow" respectively.

Basic Measurement Functions

DM3058/DM3058E contains following basic functions:

- To Measure DC Voltage
- To Measure AC Voltage
- To Measure DC Current
- To Measure AC Current
- To Measure Resistance
- To Measure Capacitance
- To Test Continuity
- To Check Diode
- To Measure Frequency and Period
- Any Sensor Measurement

To Measure DC Voltage

The Multimeter enables to measure DC Voltage up to 1000V. For the details about how to connect and measure please refer to the following steps.

(NOTE: DC Voltage is always the selected function when the instrument is turned on)

Operating Steps:

1. Press  on the Front Panel to enter into the DC Voltage Measurement interface.

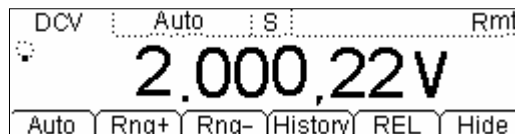

Figure 2-4 DC Voltage Measurement Interface

2. Connect the red lead to terminal Input-HI and black lead to terminal Input-LO as the figure below.

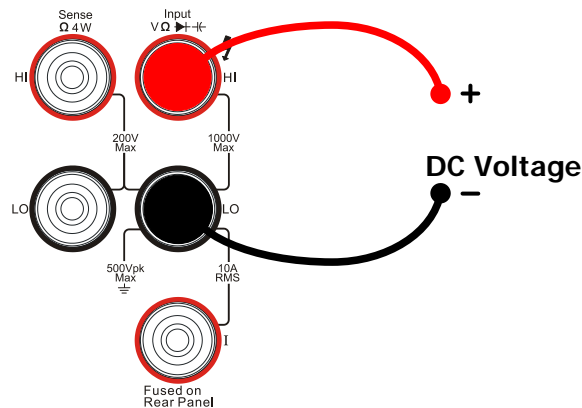

Figure 2-5 Sketch map for connecting

- Choose a proper Voltage range according to the measured circuit.

Table 2-1 Measurement Characteristics of DC Voltage

Ranges*	200mV, 2V, 20V, 200V, 1000V
Input Protection	1000V on all ranges (HI terminal)
Configurable Parameters	Range, DC input impedance, REL

NOTE*: All the ranges enable to obtain 20% value higher than original except 1000V. Besides, both Manual and Auto are available for setting every range. When inputting range is higher than 1000V at 1000V Level, "OVER LOAD" will be shown on the screen. 1000V input protection exists in every range.

- Set the DC input impedance
Press **Meas** → **Res** to set the DC resistance as "10 MΩ (default value)" or ">10 GΩ". Users can execute DC voltage measurement directly without modifying this parameter which has been setup before leaving factory.
- Set relative value (Optional)
Press **REL** to open or close Relative math function. When it is open, "REL" is shown over the screen and the reading displayed is a relative value which comes from the result of actual measurement value subtracts the value that has been set. (For the details about how to set, please refer to "**Math Functions**" in Chapter 2.)
- Read measurement result
Select required measurement (reading) rate by using Left or Right direction keys and read the measurement result.
- View history data
Press **History** to enter into the following interface and check the data getting from this measurement and saved.

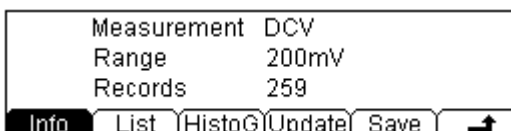

Figure 2-6 View interface of history data

There are three types of way for viewing historical data: "Info", "List" and "HistoG". Press **Save** after checking, by pressing **Update**, the History information will be refreshed to be current newest information.

To Measure AC Voltage

The Multimeter enables to measure AC Voltage up to 750V. For the details about how to connect and measure please refer to the following steps.

Operating Steps:

1. Press  to enter into the AC Voltage Measurement interface.



Figure 2-7 AC Voltage Measurement Interface

2. Connect the red lead to terminal Input-HI and black lead to terminal Input-LO as the figure below.

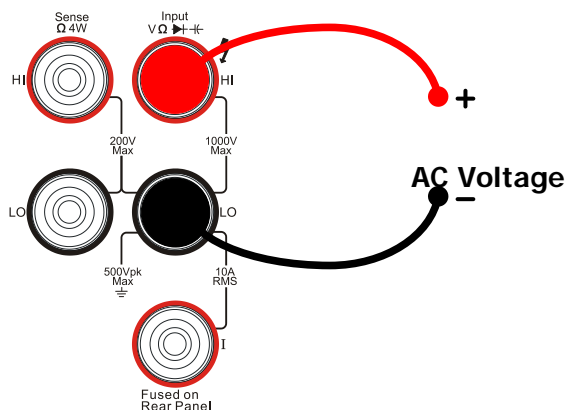

Figure 2-8 Sketch map for connecting

3. Choose a proper Voltage range according to the measured circuit

Table 2-2 Measurement Characteristics of AC Voltage

Ranges*	200mV, 2V, 20V, 200V, 750V
Input Protection	750Vrms on all ranges (HI terminal)
Configurable Parameters	Range, REL

NOTE*: All the ranges can obtain 20% value higher than original except 750V. Besides, both Manual and Auto are available for setting every range. When inputting range is higher than 750V at 750V Level, it will indicate "OVER LOAD". 750Vrms input protection exists in every range.

4. Set relative value (Optional)

Press **REL** to open or close Relative math function. When it is open, "REL" is shown over the screen and the reading displayed is a relative value which comes from the result of actual measurement value subtracts the value that has been set. (For the details about how to set, please refer to "**Math Functions**" in Chapter 2.)

5. Read measurement result

Select required measurement (reading) rate by using Left or Right direction keys and read the measurement result. By this time, press **2ND** and **Freq** to get the frequency value measured from inputted AC signal.

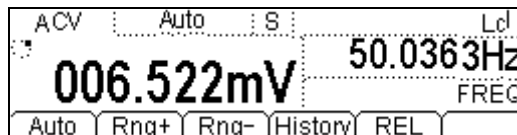

Figure 2-9 Double display

6. View history data

Press **History** to enter into the following interface and check the data getting from this measurement and save.



Figure 2-10

View interface of history information

There are three types of way for viewing historical date: "Info", "List" and "HistoG". Press **Save** after checking. By pressing **Update**, the History information will be refreshed to be current newest information.

To Measure DC Current

The Multimeter enables to measure DC Current up to 10A. For the details about how to connect and measure please refer to the following steps.

Operating Steps:

1. Press  to enter into the DC Current Measurement interface.

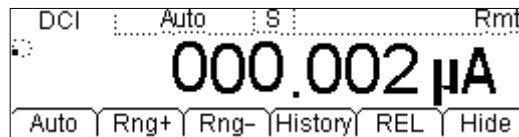

Figure 2-11 DC Current Measurement Interface

2. Connect the red lead to terminal Input-I and black lead to terminal Input-LO as the figure below.

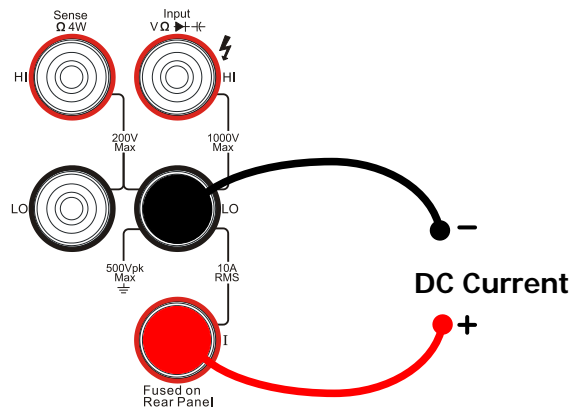

Figure 2-12 Sketch map for connecting

- Choose a proper Current range according to the measured circuit.

Table 2-3 Measurement Characteristics of DC Current

Ranges*	200μA, 2mA, 20mA, 200mA, 2A, 10A
Input Protection	10A (Rear Panel) 12A (Inside the instrument)
Configurable Parameters	Range, REL

NOTE*: All the ranges enable to obtain 20% value higher than original except 10A. Besides, both Manual and Auto are available for setting every range.

- Set relative value (Optional)
Press **REL** to open or close Relative math function. When it is open, "REL" is shown over the screen and the reading displayed is a relative value which comes from the result of actual measurement value subtracts the value that has been set. (For the details about how to set, please refer to "**Math Functions**" in Chapter 2.)
- Read measurement result
Select required measurement (reading) rate by using Left or Right direction keys and read the measurement result.
- View history data
Press **History** to enter into the following interface and check the data getting from this measurement and save.

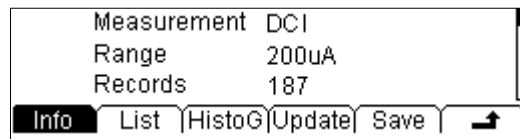

Figure 2-13
View Interface of History Information

There are three types of way for viewing historical date: "Info", "List" and "HistoG". Press **Save** after checking. By pressing **Update**, the History information will be refreshed to be current newest information.

To Measure AC Current

The Multimeter enables to measure AC Current up to 10A. For the details about how to connect and measure please refer to the following steps.

Operating Steps:

1. Press  to enter into AC Current Measurement interface.

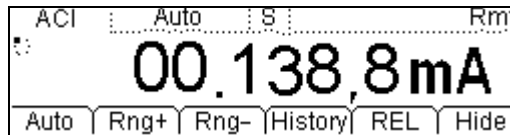

Figure 2-14 AC Current Measurement Interface

2. Connect the red lead to terminal Input-I and black lead to terminal Input-LO as the figure below.

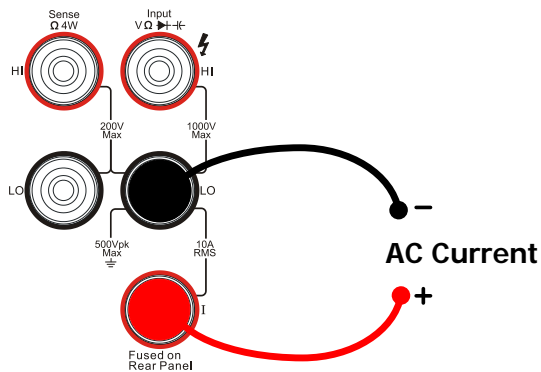

Figure 2-15 Sketch map for connecting

- Choose a proper Current range according to the measured circuit

Table 2-4 Measurement Characteristics of AC Current

Ranges*	20mA, 200mA, 2A, 10A
Input Protection	10A(Rear Panel), 250V(Fuse), 12A(Inside the instrument)
Configurable Parameters	Range, REL

NOTE*: All the ranges enable to obtain 20% value higher than original except 10A. Besides, both Manual and Auto are available for setting every range.

- Set relative value (Optional)
 Press **REL** to open or close Relative math function. When it is open, "REL" is shown over the screen and the reading displayed is a relative value which comes from the result of actual measurement value subtracts the value that has been set. (For the details about how to set, please refer to "**Math Functions**" in Chapter 2.)
- Read the measurement result
 Select required measurement (reading) rate by using Left or Right direction keys and read the measurement result.
- View history data
 Press **History** to enter into the following interface to check the data getting from this measurement and save.

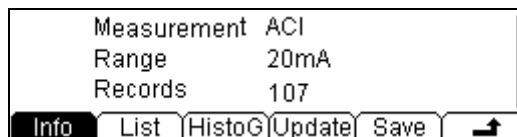

Figure 2-16 View interface of history information

There are three types of way for viewing historical date: "Info", "List" and "HistoG". Press **Save** after checking, by pressing **Update**, the History information will be refreshed to be current newest information.

To Measure Resistance

The multimeter provides 2-wire and 4-wire resistance measurement modes which are introduced separately in the following part.

2-Wire Resistance Measurement

Operating Steps:

1. Press Ω and select 2-Wire Resistance Measurement Mode to enter following interface.

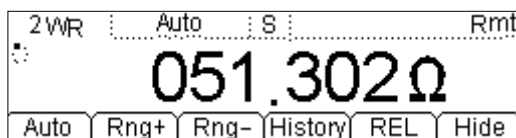

Figure 2-17 2-Wire Resistance Measurement Interface

2. Connect the red lead to terminal Input-HI and black lead to terminal Input-LO as the figure below.

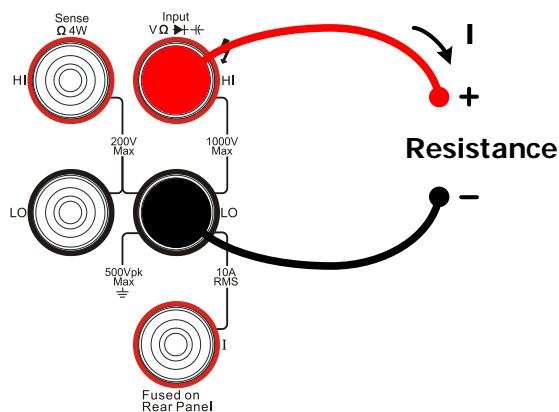

Figure 2-18 Sketch map for connecting

- Choose a proper Resistance range according to its scope.

Table 2-5 Measurement Characteristics of Resistance

Ranges*	200Ω, 2kΩ, 20kΩ, 200kΩ, 2MΩ, 10MΩ, 100MΩ
Open-circuit Voltage	<8V
Input Protection	1000V on every range (HI terminal)
Configurable Parameters	Range, REL

NOTE*: All the ranges enable to obtain 20% ranges higher than original. Besides, both Manual and Auto are available for setting every range.

- Set relative value (Optional)
Press **REL** to open or close Relative math function. When it is open, "REL" is shown over the screen and the reading displayed is a relative value which comes from the result of actual measurement value subtracts the value that has been set. (For the details about how to set, please refer to "**Math Functions**" in Chapter 2.)
- Read the measurement result
Select required measurement (reading) rate by using Left or Right direction keys and read the measurement result.
- View history data
Press **History** to enter into the following interface to check the data getting from this measurement and save.

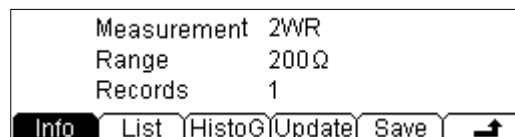

Figure 2-19 View interface of history information

There are three types of way for viewing historical date: "Info", "List" and "HistoG". Press **Save** after checking, by pressing **Update**, the History information will be refreshed to be current newest information.

NOTE

You are suggested to make use of Relative function when measuring small resistance to reduce or escape impedance error from Test leads.

4-Wire Resistance Measurement

When the measured resistance is smaller than $100\text{k}\Omega$, if both the resistance of Test leads and the contact resistance between probe and testing point are too big to be ignored as comparing with measured resistance, the error will be increased provided that you insist on measuring by via 2-Wire Resistance. So please change it to 4-Wire.

Operating Steps:

1. Press Ω twice to switch to 4-Wire Resistance Mode.

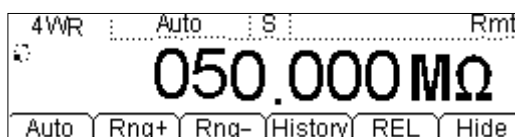

Figure 2-20 Measurement Interface

2. Connect the red leads to terminal Input-HI and HI Sense and black leads to terminal Input-LO and LO Sense as the figure below.

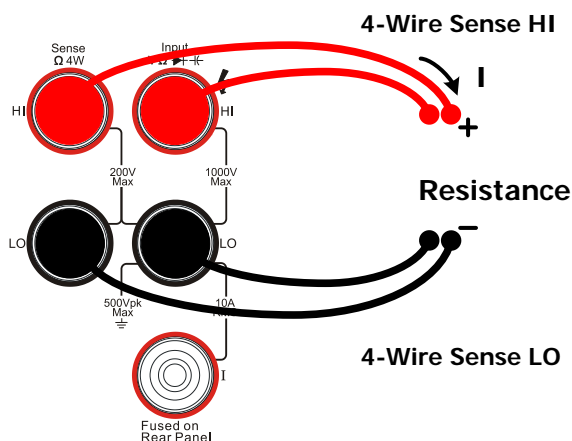

Figure 2-21 Sketch map for connecting

- Choose an appropriate resistance range according to its scope.

Table 2-6 Measurement Characteristics of 4-Wire Resistance

Ranges*	200Ω, 2kΩ, 20kΩ, 200kΩ, 2MΩ, 10MΩ, 100MΩ
Open-circuit Voltage	<8V
Import Protection	(1) 1000V on each range (HI terminal) (2) 200V on each range (HI Sense, LO Sense)
Configurable Parameters	Range, REL

NOTE*: All the ranges enable to obtain 20% ranges higher than original. Besides, both Manual and Auto are available for setting every range.

- Set relative value (Optional)
Press **REL** to open or close Relative math function. When it is open, "REL" is shown over the screen and the reading displayed is a relative value which comes from the result of actual measurement value subtracts the value that has been set. (For the details about how to set, please refer to "**Math Functions**" in Chapter 2.)
- Read the measurement result
Select required measurement (reading) rate by using Left or Right direction keys and read the measurement result.
- View history data
Press **History** to enter into the following interface and check the data getting from this measurement and save.

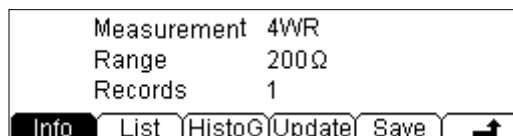

Figure 2-22 History Information

There are three types of way for viewing historical date: "Info", "List" and "HistoG". Press **Save** after checking. By pressing **Update**, the History information will be refreshed to be current newest information.

NOTE

Please do not put the terminals of the resistance on the conductive plane or in your hand to avoid error.

The bigger of the resistance, the more affection it will be brought.

To Measure Capacitance

The DM3058/DM3058E Digital Multimeter has the ability to test Capacitance up to 10000 μ F.

Following practice provides you a guide to get familiar with the Capacitance measurement technique.

Operating Steps:

1. Press  to enter into Capacitance measurement interface.

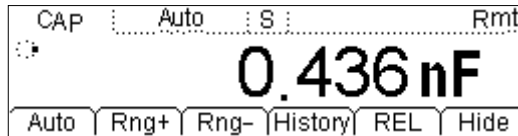

Figure 2-23
Capacitance Measurement Interface

2. Connect red lead to both terminal Input-HI and anode of the capacitance and black lead to both terminal Input-LO and cathode of the capacitance as the figure below.

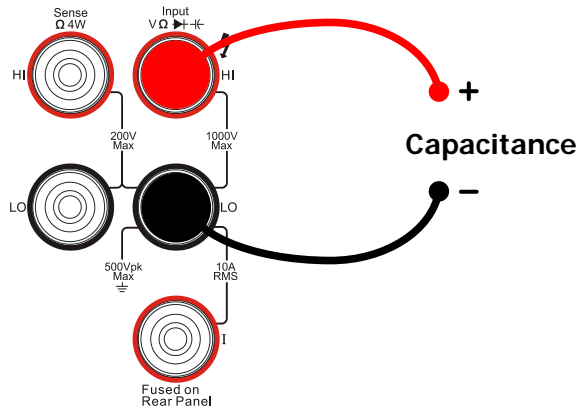

Figure 2-24 Sketch map for connecting

- Choose an appropriate measurement range according to its scope.

Table 2-7 Capacitance Measurement Characteristics

Ranges*	2nF, 20nF, 200nF, 2 μ F, 200 μ F, 10000 μ F
Input Protection	1000V on all ranges (HI terminal)
Configurable Parameters	Range, REL

NOTE*: All the ranges enable to obtain 20% ranges higher than original. Besides, both Manual and Auto are available for setting every range.

- Set relative value (Optional)
Press **REL** to open or close Relative math function. When it is open, "REL" is shown over the screen and the reading displayed is a relative value which comes from the result of actual measurement value subtracts the value that has been set. (For the details about how to set, please refer to "**Math Functions**" in Chapter 2.)
- Read the measurement result
Capacitance measurement is fixed at "Slow" rate, 3.5 digits resolution. Therefore, you cannot adjust the reading rate when reading the result.
- View history data
Press **History** to enter into the following interface and check the data getting from this measurement and save.

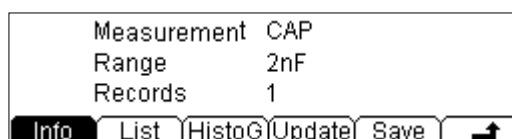

Figure 2-25 View interface of History information

There are three types of way for viewing historical date: "Info", "List" and "HistoG". Press **Save** after checking. By pressing **Update**, the History information will be refreshed to be current newest information.

NOTE

Before measuring the electrolytic capacitance, you should make the two legs of the electrolytic capacitance short circuit and let it be discharged.

To Test Continuity

When the measured resistance in circuit is lower than selected one, it is considered being connected by instrument. Next, we will introduce you how to test continuity for circuit by using DM3058/DM3058E step by step to make you familiar with this technique.

Operating Steps:

1. Press  to enter into the following interface.

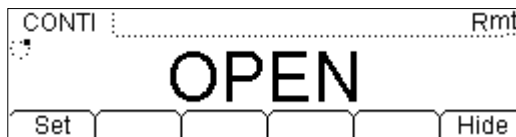

Figure 2-26 Continuity Testing Interface

2. Connect test leads as the figure below. Red lead connects with HI terminal; Black lead connects with LO terminal.

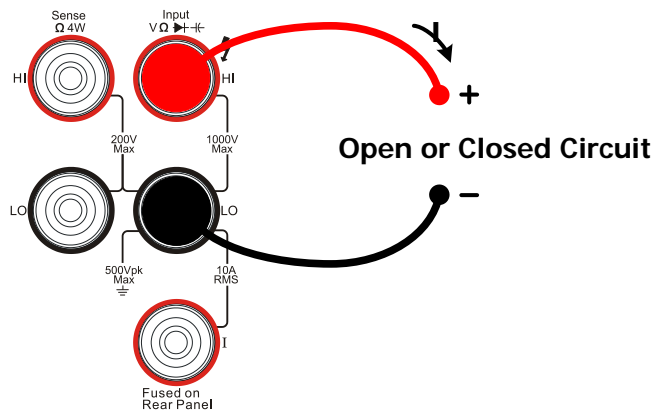

Figure 2-27 Sketch map for testing

3. Set the Short-circuit resistance.
Press **Set** to set up the resistance of short-circuit. The default value is set as 10Ω when leaving factory. Users may carry on the Continuity measurement directly without modification.

Table 2-8 Continuity Measurement Characteristics

Test Current	1mA
Range	Fixed at 2k Ω
Open-circuit Voltage	<8V
Input Protection	1000V (HI terminal)
Beep Condition	$0 \leq R_{\text{testing}} \leq \text{Short-circuit impedance};$ $1\Omega \leq \text{Short-circuit impedance} \leq 2\text{k}\Omega$

To Check Diode

Operating Steps:

1. Press  to enter into the following interface.



Figure 2-28 Testing interface of Diode

2. Connect red lead to both terminal Input-HI and anode of the Diode and black lead to both terminal Input-LO and cathode of the Diode as the figure below.

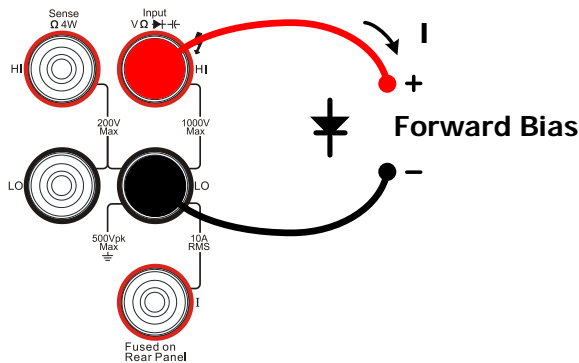

Figure 2-29 Sketch map for connecting

3. Check the connection state of Diode.
When connecting, the instrument will beep one time (If Sound is open).

Table 2-9 Check Diodes Characteristics

Test Current	1mA
Range	Fixed at 2.0V
Open-circuit Voltage	<8V
Input Protection	1000V (HI terminal)
Beep Condition	$0.1V \leq V_{\text{measured}} \leq 2.0V$

To Measure Frequency and Period

The Frequency or Period of a signal could be obtained by Secondary Function during testing its voltage or current or by function button **Freq**. The following practice provides a guide to get familiar with the Frequency and Period measurement.

To Measure Frequency

Operating Steps:

1. Press **Freq** to enter into the following interface.

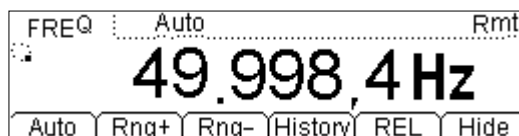

Figure 2-30 Frequency Measurement Interface

2. Connect test leads as the figure below. Red test lead connects with terminal HI; Black test lead connects with terminal LO.

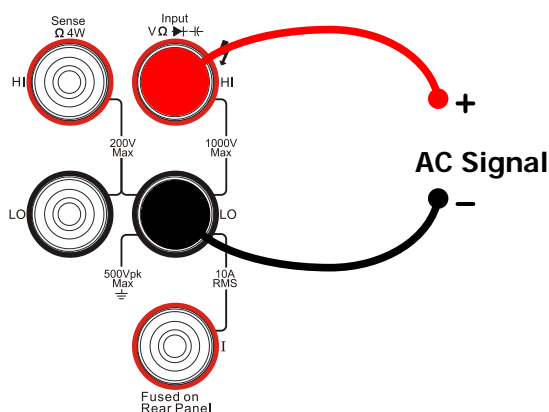

Figure 2-31 Sketch map for connecting

Table 2-10 Frequency Test Characteristics

Ranges	200mV, 2V, 20V, 200V, 750V
Input Signal Range	20Hz ~ 1MHz
Input Protection	750V _{RMS} on all ranges (HI terminal)
Configurable Parameters	REL

3. Set the relative value (Optional).
 Press **REL** to open or close Relative operation function. When it is open, "REL" is shown over the screen and the reading displayed is a relative value which comes from the result of Actual measurement value subtracts the value that has been set. (For the details about how to set, please refer to "**Math Functions**" in Chapter 2.)

4. Read measurement value
 Frequency measurement is fixed at "Slow" rate, 5.5 digits resolution. Therefore, you cannot adjust the reading rate when reading the result.

5. View history data
 Press **History** to enter into the following interface and check the data getting from this measurement and saved.



Figure 2-32 View interface of History information

There are three types of way for viewing historical date: "Info", "List" and "HistoG". Press **Save** after checking. By pressing **Update**, the History information will be refreshed to be current newest information.

To Measure Period

Operating Steps:

1. Press **Freq** until enter into the following interface.

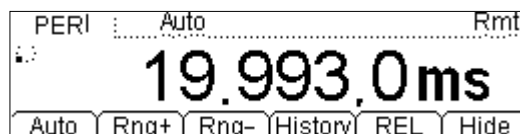

Figure 2-33 Period Measurement Interface

2. Connect the red lead to terminal-HI and black lead to terminal LO as the figure below.

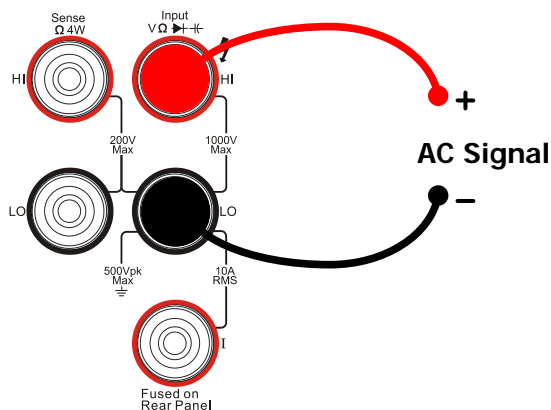

Figure 2-34 Sketch map for connecting

Table 2-11 Period Characteristic

Ranges	200mV, 2V, 20V, 200V, 750V
Measurement Range	1 μ s~0.05s
Input Protection	750V _{RMS} (HI)
Configurable Parameters	REL

3. Set the relative value (Optional)
Press **REL** to open or close Relative operation function. When it is open, "REL" is shown over the screen and the reading displayed is a relative value which comes from the result of Actual measurement value subtracts the value that has been set. (For the details about how to set, please refer to "**Math Functions**" in Chapter 2.)

4. Read the measurement value
Period measurement is fixed at "Slow" rate, 5.5 digits resolution. Therefore, you cannot adjust the reading rate when reading the result.

5. View history data
Press **History** to enter into the following interface and check the data getting from this measurement and save.



Figure 2-35
View Interface of History Information

There are three types of way for viewing historical date: "Info", "List" and "HistoG". Press **Save** after checking. By pressing **Update**, the History information will be refreshed to be current newest information.

Any Sensor Measurement

By using any sensor measurement, you can connect Pressure Sensor, Flux Sensor or Temperature Sensor easily. Its principle is that transmit measured physical quantity to a facile measured one such as Voltage, Resistance and Current by these steps. First, pre-input the needed data; secondly, transform or modify it according to the interior arithmetic of Multimeter. Afterward, a measured physical quantity of Sensor is shown on the screen directly and you can edit or modify its display unit at will.

The multimeter supports DCV, DCI, and Freq, 2WR, 4WR and Thermocouple TC 6 kinds of Sensor in all. Meanwhile, there are 10 groups of basic Sensor preset within the instrument.

Connection

Different Sensor has different connecting ways. As the Voltage Sensor, Resistance Sensor, Thermocouple Sensor and Frequency Sensor, please Connect the red lead to terminal Input-HI and black lead to terminal Input-LO as the figure below.

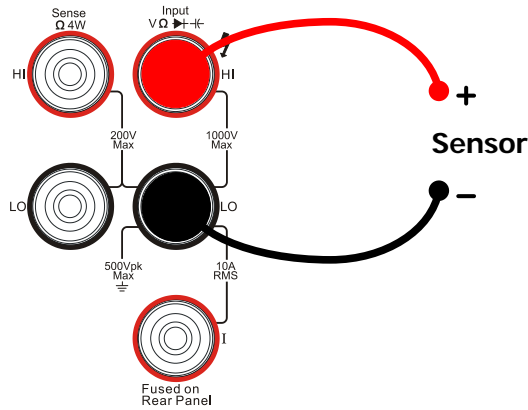

Figure 2-36 Sketch map for connecting

As the Current Sensor, please connect the red lead to terminal Input-I and black lead to terminal Input-LO as the figure below.

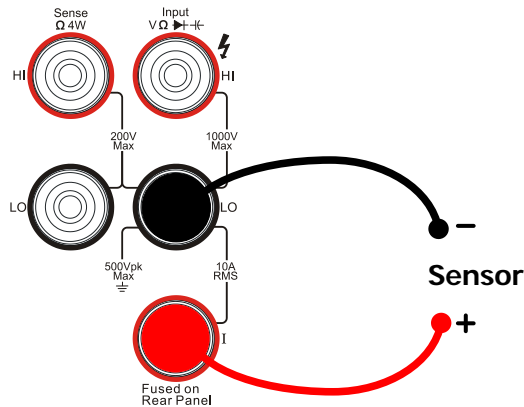



Figure 2-37 Current Sensor Connecting

Basic measurement method

Press  to enter into the following interface.

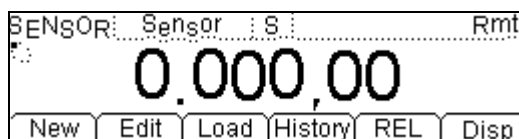

Figure 2-38
Measurement Interface of Sensor

Table 2-12 Characteristics of Sensor

Function	Description
New	Built a new configuration file of Sensor
Edit	Edit an existing configuration file
Load	Load an existing configuration file
History	Check newest 1000 measurement datum
REL	Open/Close Relative Operation
Disp	Set sensor measurement display mode

1. Press **New** to create a new Sensor.

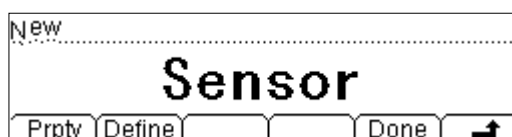

Figure 2-39 New interface

- (1) Press **Prpty** to enter into the input interface.

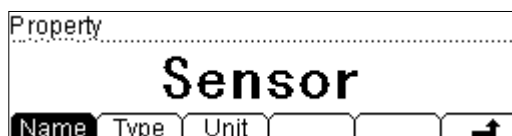

Figure 2-40 Property Interface

- Press **Name** to create an appropriate name for the new sensor.

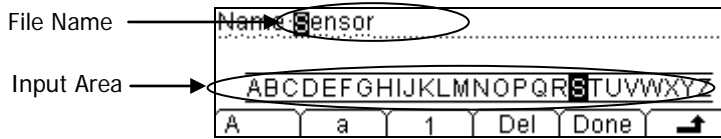

Figure 2-41 Name edit interface

File Name Input Method:

- Use the up/down direction keys to select the File Name or Input Area.
- Use the left/right direction keys to move the cursor to the position (File Name Area) or character (Input Area).
- Press **A**, **a** and **1** to select the Capital letter, Lowercase letter or Numbers.
- The **Del** function can only delete the letter on which the cursor taking place.
- Press **Done** to save current file.
- Press **↩** to return to the **Prpty** interface.

- Press **Type** to select the type of easy-to-measure physical quantity (**DCV**, **DCI**, **2WR**, **4WR**, **FREQ** and **TC**). Press the corresponding menu to select the type and then, press **↩** to return to the **Prpty** interface.

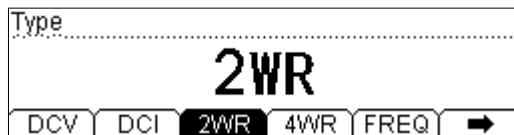

Figure 2-42 Type selection interface

- Press **Unit** button to select the unit (**°**, **°C**, **°F** and **%**) for the measured physical quantity. Furthermore, you can define a desired unit using the **USER** function.

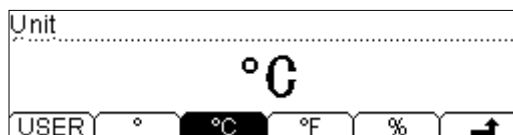

Figure 2-43 Unit selection interface

Explanations:

User-defined unit is limited within two characters.

Switch to the character which needs to be edited by the left/right direction keys.

Select required characters by the up/down direction keys from A-Z and a-z.

- Press **↩** to return to the **New** interface and do next steps.
- (2) Press **Define** to input corresponding data. Different kind of Sensor has different relationship of corresponding data. It is not necessary to input plenty reference value if the corresponding relationship has more smoothness and good linearity curve. Then press **Add** to input reference data.
- Press **Meas** to input the data measured from Sensor by Direction keys.

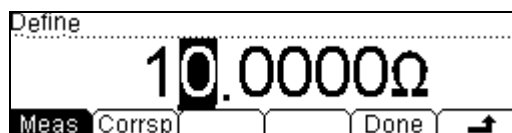

Figure 2-44 Input data

- Press **Corrsp** to input the corresponding data by Direction keys.

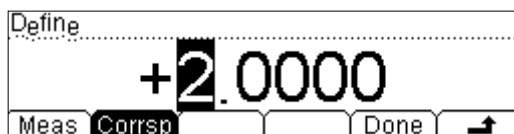

Figure 2-45 Input data

- Press **Done** to finish the input for first group of data and go back to View Interface of Reference value. Please pay attention that **↗** indicates the approximate arithmetic of datum between this data and next one. The arithmetic of first data sect is default as "Line" which can be modified by clicking **Edit**.

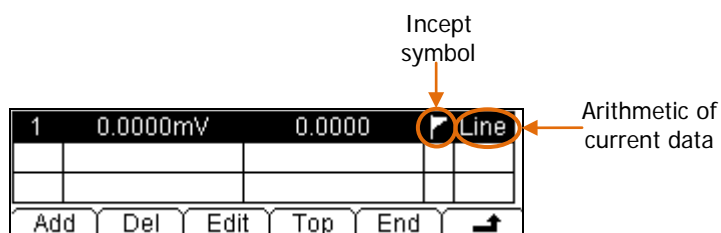



Figure 2-46 View interface of Reference data

- Reprress **Add** to input second group of data. From this group you can press **SEG** → "Open" → **Arith** and select arithmetic.



Figure 2-47 On/Off section interface of Arithmetic

- Press  to finish the parameter settings and return to the **New** interface (figure 2-39).

(3) Press **Done** (figure 2-39), it will appear **Save** and **Apply** options.

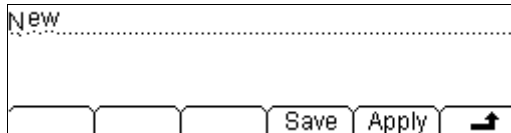

Figure 2-48 Finishing interface

- Press **Save** and input needed File Name.

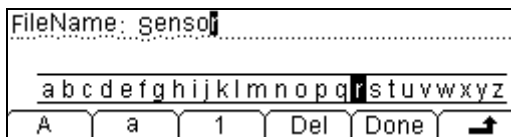

Figure 2-49 Finishing interface

- Press **Done** and store the parameter of Sensor as appointed name for future using.

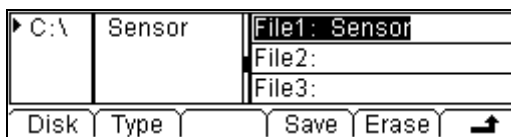



Figure 2-50 Save Interface

- Press  and return to the **New** interface.
- Press **Apply** as shown in figure 2-48 and load settings into current Sensor and use it directly.

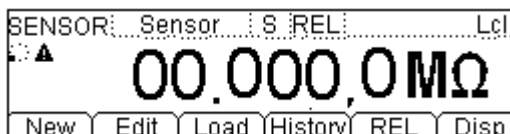

Figure 2-51 Apply new Sensor

After application, the data appearing in the interface is unavailable by "▲".

2. If you found there are some problems existing please press **Edit** to modify.

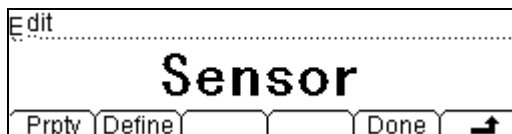

Figure 2-52 Edit configuration file of Sensor

3. Press **Load** to recall configuration file within Sensor.
4. Press **History** to enter into the following interface to check the data getting from this measurement and save.

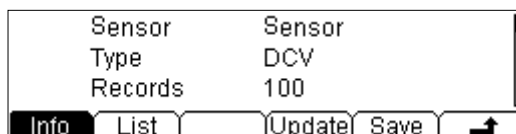

Figure 2-53 View interface of History Information

There are three types of way for viewing historical date: "Info" and "List". Press **Save** after checking, by pressing **Update**, the History information will be refreshed to be current newest information.

5. Set relative value (optional)
Press **REL** to open or close Relative operation. When it is open, "REL" is shown over the screen and the reading displayed is a relative value which comes from the result of actual measurement value subtracts the value that has been set. (For the details about how to set, please refer to "**Math Functions**" in Chapter 2.)
6. Press **Disp** to set the display mode for the measurement result: only display the measured result (select **Meas**); only display the corresponding result (select **Corrsp**); when **All** is selected, the measured result will be shown on the Vice display and the corresponding result will be shown on the Main display.

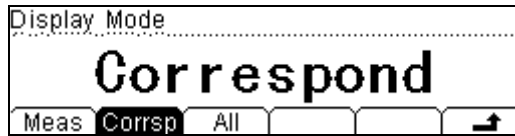

Figure 2-54 Display mode

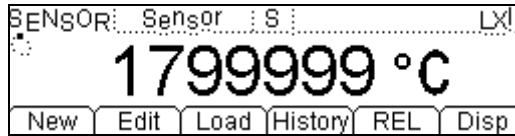



Figure 2-55 Display the value

Preset

Preset mode is provided to avoid error operation via testing product line. In any operation mode, please press  to enter into following menu.

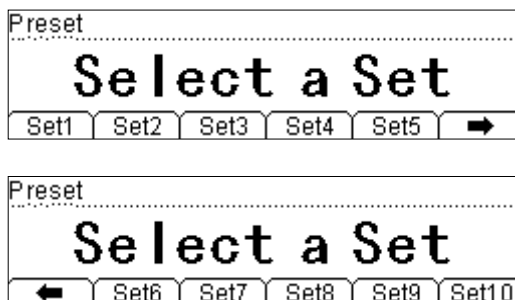





Figure 2-56 Interface of Preset

Ten sets existing in preset mode and all of them are corresponding with the 10 configuration files in configuration memorizer respectively.

Press **Set n** ($n=1\sim 10$) to recall the corresponding settings and exit Preset menu.

Explanations:

- A click will be emitted by instrument after you press any preset configuration key if an effective configuration is existing in its Location of corresponding key, meanwhile, current measurement configuration will be refreshed to the one has been stored. If the selective configuration location is empty, the instrument will emit "click → pause → click" and then go back to primary testing state.
- Press  →  → **Set n** , current measurement configuration would be saved into corresponding location and named "Set n " as a default.
- Besides, you can also recall or save preset configuration by using  function.

Secondary Function

Secondary function button  is used to open double display, save current instrument settings and open the REL setting interface quickly.

1. Open Double Display

Press , this button will shine and the instrument is going to wait for the secondary operation. By this time, if you press a function key, it will be displayed in the Vice Display (for available combination, see table 2-13).

Table 2-13 Available Main/Vice Function Combination (shade is available)

		Main Display Function								
		DCV	DCI	ACV	ACI	FREQ	PERIOD	2WR	4WR	Cap
Vice Display Function	DCV									
	DCI									
	ACV									
	ACI									
	FREQ									
	PERIOD									
	2WR									
	4WR									
	Cap									

Explanations:

- (1) If the same measurement function is used in both Main and Vice Display
 - The readings in both of the display will update at the same time.
 - If Math function (STA, REL, dBm and dB) is used in Main Display, when opening Vice Display, the result will be shown in Main Display and the measurement value before math operation is shown in Vice Display.
 - If Math function (P/F) is used in Main Display, when open Vice Display, P/F operation will be closed automatically and Vice Display will show the second selected function normally.

- (2) If different measurement functions are used in both Main and Vice Display
 - The readings in both of the display will update alternately.
 - If Math function (STA, P/F, dBm and dB) is used in Main Display, when open

Vice Display, math operation will be closed automatically and Vice Display will show the second selected function normally.

- If Math function (REL) is used in Main Display, when open Vice Display, the result will still be shown in Main Display and Vice Display will show the second selected function normally.
- (3) If Sensor is used in Main Display, set the display mode (Sensor → Disp → All), then the result (corresponding value) will be shown in Main Display and the current measurement value is shown in Vice Display.
- (4) Auto Range is adopted by Vice Display. If the same measurement function is used in both the display, so does the range.
- (5) Measured data in Vice Display cannot be saved into "History".



2. Save Current Settings Quickly

Press **Preset** → **2ND** **MO**, and then press any **Setn** key, the instrument will store current instrument settings to corresponding memory with default filename "Setn". You can also finish this operation through the **Save** function (see the Store and Recall section).

3. Open REL Settings Interface Quickly

In general measurement interface, press **2ND** **MO**, then press the **REL** menu to enter **Figure 2-65 Relative operation setting interface** immediately.

To Control Trigger Options

 or  could be used to trigger the multimeter. Auto trigger is considered as a default when the power is on. Then  key will be lightening which indicates this function has been started.

Optional trigger modes of the multimeter contain Auto Trigger, Single Trigger and Hold Trigger.

Auto Trigger

Once you press  one time, Auto Trigger will be started to capture continuous readings automatically.

Single Trigger

Press  on the Front Panel, Single Trigger will be started one time and generate an effective reading.

Holding Trigger

Press  key, it allows capturing and holding a stable reading on the front panel display.

NOTE

Press  in Remote Mode to switch back to the local mode.

To Set up Measurement Parameters

Press **Meas** to set measurement parameters for DC Voltage, DC Current and Continuity.

The parameters have been configured when the multimeter leaving factory. So you can either measure directly or modify them to meet your requirements.

AC Filter

AC Filter is applicable for DC Voltage and DC Current measurement.

While either DC Voltage or DC Current function is selected, press **Meas** → **Filter**, enter the menu shown below. If AC component existing in inputted DC signal, it can be filtered by AC Filter so as to make the data more exactly.

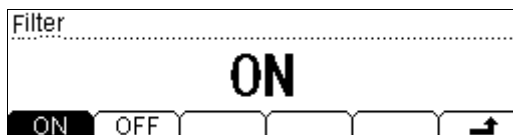

Figure 2-57 Open/Close AC Filter

DC Input Impedance

DC input impedance is applicable for DC voltage measurement.

Press **Meas** → **Res** enter the menu shown below when select DC voltage measure function.

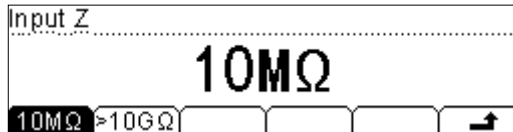

Figure 2-58 Choose DC Impedance

Table 2-14 DC Input Impedance Menu Description

Function Menu	Description
10MΩ	Set up the DC Input Impedance to 10MΩ.
>10GΩ	Set up the DC Input Impedance to >10GΩ.
↗	Save all changes, back to a higher level menu.

The options of input impedance for DC voltage measurements are 10MΩ and >10GΩ. 10MΩ impedance is general for the multimeter, but for 200mV and 2V ranges, >10GΩ should be chosen for better result. The current selection will be saved in nonvolatile memory.

DC input impedance selection:

- While the DC input impedance is selected to **10MΩ**, the input impedance of all measurement range is 10MΩ;
- While the DC input impedance is selected to **>10GΩ**, the input impedance for 200mV and 2V measurement range is >10GΩ; for 20V, 200V and 1000V measurement range is kept at 10MΩ.
- The DC input impedance default is 10 MΩ; settings of DC input impedance are stored in the nonvolatile memory.

Short-circuit Resistance

Set up the short-circuit resistance value in the short-circuit test menu. When the measured resistance is lower than the short-circuit resistance, the circuit is considered as connected, and the beeper sounds (if sound is on). The short-circuit resistance is only applicable to the continuity test.

Press **Meas** → **Conti**, enter the menu shown below:

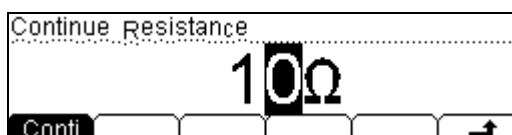

Figure 2-59 Set up the short-circuit resistance

Use direction keys to change the parameter values:

Press left and right directional keys to choose different digits. Press up and down keys to change the current digit value.

Continue Resistance

- The range of short-circuit resistance is $1\Omega\sim 2000\Omega$. The default value is 10Ω .
- The short-circuit resistance value is stored in the nonvolatile memory and the resistance remains unchanged after power-off.

Math Functions

The multimeter provides five math functions: STA, P/F, dBm, dB and REL testing.

Math functions can only be used in DC voltage, AC voltage, DC current, AC current, resistance, frequency/period and sensor measurement. Among the functions, dBm and dB are only used in DC voltage and AC voltage measurement.

Press **Math** key, the display shows:

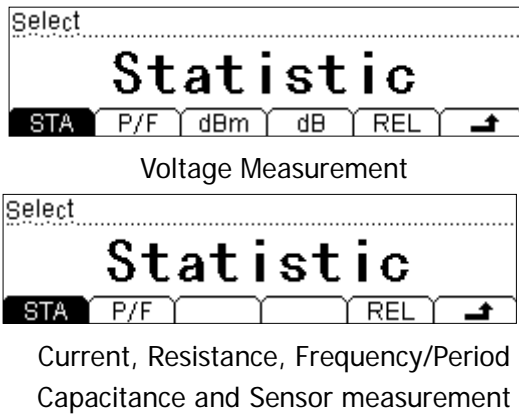

Figure 2-60 Math function

Table 2-15 Math Function Menu Description

Function Menu	Settings	Description
STA		Reading statistic functions, including: Max, Min, Average, and number of measurement.
P/F		The P/F test function performs pass/fail testing according to the specified upper and lower limits.
dBm		The dBm function is logarithmic, and is based on a calculation of power delivered to reference impedance.
dB		The dB measurement is the difference between the input signal and a stored relative value.
REL	ON OFF	Turn on /Turn off the REL function.
↗		Save all changes, back to a higher level menu.

Statistic Measurement

The Statistic function is for DC voltage, AC voltage, DC current, AC current, resistance, frequency/period, capacitance and sensor measurement.

The front panel can display the statistical data for any set of readings: average (AVG), maximum (MAX), minimum (MIN), and which can read with All functions and the number of samples taken (Total).

Press **Math** → **STA**, the display shows:

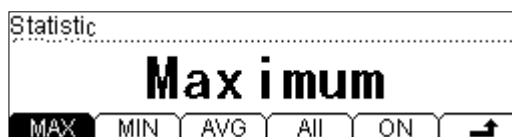

Figure 2-61 Stat. Math

Table 2-16 Statistic Measurement Menu Function Description

Function Menu	Settings	Description
MAX		To show the maximum statistic value of current measurement
MIN		To show the minimum statistic value of current measurement
AVG		To show the average statistic value of current measurement
All		To show all statistic values of current measurement
ON	ON OFF	Turn on/off the selected statistic measurement
↗		Save all changes, back to a higher level menu.

Statistic function

- In statistic function, the first reading is usually set to the maximum or minimum value. When getting more readings, current displaying value is always the maximum/minimum reading among all the measured values.
- The maximum, minimum, average and reading quantities are stored in volatile memory.

P/F Measurement

P/F function is available to prompt signals beyond ranges according to the upper and lower parameters. Following are some measurement functions which are able to do limit operation: DC Voltage, AC Voltage, DC current, AC current, Resistance, Frequency, Capacitance and Sensor.

Press **Math** → P/F, the display shows:

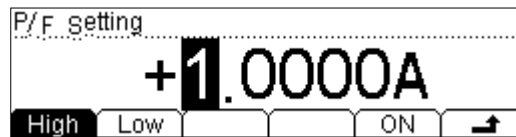

Figure 2-62 P/F Setting

Table 2-17 P/F Measurement Menu Function Description

Function Menu	Settings	Description
High		Set the desired Upper limit.
Low		Set the desired Lower limit.
ON		Open P/F Measurement, Status bar shows "P/F".
↗		Save all changes, back to a higher level menu.

1. Set P/F

Select **High** or **Low**, and then switch to the needed digit by Left or Right Direction keys and input numerical value by Up and Down Direction keys. Use Left key to pitch on symbol on the left side when setting Positive or Negative and switch them by Up and Down Direction keys.

2. Unit

The unit of P/F is decided by the current measurement function.

3. Over P/F hint

When the readings exceed selected upper limit, the vice-screen will show "HI FAIL".

When the readings exceed selected lower limit, the Vice display will show "LO FAIL."

When the readings exceed either upper or lower limit, an alarm will be given (when the sound is open).

The range of P/F function:

- The P/F range is -120%~ +120% of the current measurement range.
- The upper limit value should be always bigger than the lower limit value.
- The upper and lower values are stored in volatile memory. They will be set to defaults when power on.

dBm Measurement

This function applies to AC voltage and DC voltage measurements only. The dBm function is logarithmic, and is based on a calculation of power delivered to a reference resistance, relative to 1 mill watt.

Press **Math** → **dBm**, the display shows:

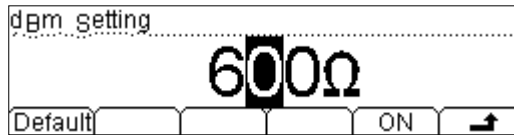

Figure 2-63 dBm setting

Table 2-18 dB Measurement Function Menu Function Description

Function Menu	Settings	Description
Default		Use the default value. The range of parameter is 2Ω ~ 8000Ω.
ON		Open dBm Measurement. Status bar shows "dBm".
↗		Save all changes, back to a higher level menu.

The computation method of the dBm:

$$\text{dBm} = 10 \times \text{Log}_{10} [(\text{Reading}^2 / R_{\text{REF}}) / 0.001\text{W}]$$

dB Measurement

The dB function applies to AC voltage and DC voltage measurements only. Each dB measurement is different between the input signal and a stored relative value, with both values converted to dBm.

Press Math → dB , enter the menu shown below:

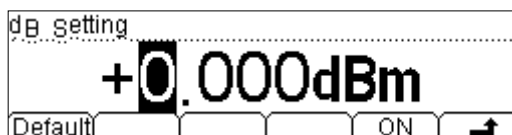

Figure 2-64 dB Setting

Table 2-19 dB Measurement Function Menu Function Description

Function Menu	Settings	Description
Default		The default value is 0 dBm.
ON		Open dB Measurement. Status bar shows "dB".
\rightarrow		Save all changes, back to a higher level menu.

The computation method of the dB:

$$\text{dB} = 10 \times \text{Log}_{10} \left[\left(\frac{\text{Reading}^2}{R_{\text{REF}}} \right) / 0.001\text{W} \right] - (\text{dB setting value})$$

R_{REF} expressed measuring the resistance value in the actual electric circuit.

Range of the dB setting value: -120 dBm ~ +120 dBm. The default is 0 dBm.

NOTE:

- Input a value in dB setting interface by direction button, and then store it as dB setting value.
- Settings of dB value are stored in volatile memory.

Relative Operation

Relative operation is used for relative measurement. Actual measurement reading is the depression between measurement value and preset value.

Press **Meas** → **REL** to enter into the following interface.

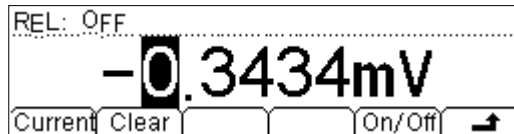

Figure 2-65 Relative operation setting interface

Table 2-20 REL operation function menu

Function Menu	Settings	Explanation
Current		To select current measurement value as preset value.
Clear		Reposition the preset value to 0.
On/Off		Open/Close this function. When opening, "REL" will be shown.
↗		Save all the changes and go back to last menu.

Main display = Measurement value – preset value

The Multimeter allows operating for following parameters: DC Voltage, AC Voltage, DC Current, AC Current, Resistance, Frequency/Period, Capacitance and Sensor.

Set preset value

- Press **2ND** → **REL** on the operating interface directly to enter into the "Preset Value" setting interface.
- Select **Current**, press **On/Off** to start REL operation, and then the readings in current set will be stored as a reference value.
- Users can input needed preset value by direction keys in the corresponding setting interface.

To Set Up Trigger Parameters

The optional Trigger methods of the multimeter include Auto Trigger, Single Trigger and External Trigger. The default trigger mode is Auto.

Press  to capture continuous readings automatically. If you repress it once more, a stable reading will be captured and hold.

Press , Single Trigger will be generated on time, and an effective reading will be captured.



Press  to set parameters for every trigger. In the following interface of Parameter setting, after you select **Auto**, **Single**, **Ext** or **VMC** on the menu, the current trigger mode shown in the parameter area will be changed accordingly and display relative parameter for current trigger.





Figure 2-66 Interface of triggering parameter

Table 2-21 Function Menu of triggering parameter

Function Menu	Settings	Description
Auto		Set interval of the auto trigger and hold range of the hold trigger. Besides, the measurement is continuous in auto trigger mode.
Single		Set Single manual trigger parameter.
Ext		Set external triggering.
VMC		Set the output signal pulse width at sampling ending output signal.
		Save all changes, back to a higher level menu.

Auto Triggering

“Interval” parameter needs to be set in auto trigger mode. Press  on the front panel to enable the auto trigger and acquire continue readings. Furthermore, auto trigger is the default mode at digital multimeter power on.

Press  → Auto, the display shows:

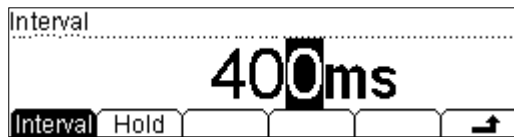



Figure 2-67 Setting interface of Auto Trigger

Table 2-22 Auto Trigger Function Menu Description

Function Menu	Settings	Description
Interval		Set interval time in 400~2000ms.
Hold	ON/OFF	Turn the Reading Hold function ON or OFF.
		Save all changes, back to a higher level menu.

1. Interval

- The interval means the waiting time before sampling since trigger signal has been sent. The interval is different under different measure speed.
Fast: the default interval is 8ms, setting range is 8ms~2000ms.
Middle: the default interval is 50ms, setting range is 50ms~2000ms.
Slow: the default interval is 400ms, setting range is 400ms~2000ms.
 The default measure speed is slow, so the default interval is 400ms.
- The interval is stored in volatile memory.

2. Reading Hold

- The reading hold mode captures and holds a reading on the front panel display when a stable reading is detected. The system Hold ranges are 0.01%, 0.1%, 1%, and 10%.

- Press  two times until this button is glittery, then a trigger will be hold and a stable reading will be captured and hold on the screen.

Press  → **Auto** → **Hold**, the display shows:

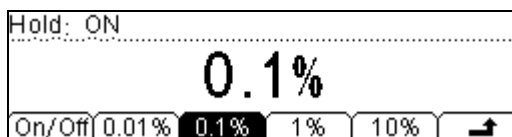



Figure 2-68 Manu interface of Reading Hold

Table 2-23 Reading Hold Function Menu Description

Function Menu	Settings	Description
On/Off		Turn on/off the reading hold function.
0.01%		Set the hold scope as 0.01%.
0.1%		Set the hold scope as 0.1%.
1%		Set the hold scope as 1%.
10%		Set the hold scope as 10%.
		Save all changes, back to a higher level menu.

Reading Hold Function

Start the Reading Hold Function, the hold measurement use the following rules judge the reading count:

When $\text{Max} () - \text{Min} () \leq \text{hold range} \times \text{Readings}$, the multimeter hold Reading on the display.

The display update a new reading basing on the current value and the three preceding measurements before the reading was hold:

Max (Reading, ReadingN-1, ReadingN-2, ReadingN-3)



Min (Reading, ReadingN-1, ReadingN-2, ReadingN-3)

NOTE:

- The default value of hold range is 0.1%, and the range setting is stored in volatile memory.
- When Reading Hold started, the input resistance was set to 10MΩ for all DC voltage ranges to reduce noise arising from the open-loop testing.

Single Triggering

The multimeter takes one reading, or a number of readings specified by a sample count you enter, each time press .

Press  → **Single** to enter into the following interface. Then Input needed sample counts by Direction keys. After setting please press **Done** to open Single Trigger, at this time **Done** is hiding and  is lighten.

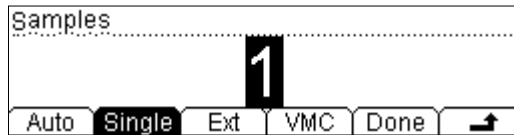

Figure 2-69 Settings of sample count

Sample Count

- Sample Count indicates the count of point sampled while the instrument getting a signal of Single Trigger.
- The range of sampling point should be between 1 and 2000.
- The default of Sample Count is 1.

External Triggering

The external trigger signal will be input via the ninth pin of RS232 interface on the rear panel. It requires setting the following parameter: the **Rise** edge and the **Fall** edge.

Press **Trig** → **Ext**, the display shows:

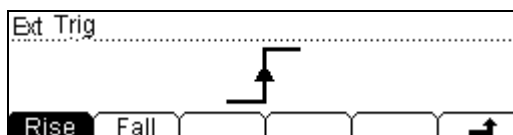

Figure 2-70 The Interface of the External Triggering

Table 2-24 Function Menu of External Triggering

Function Menu	Settings	Explanation
Rise		Set the External Trigger Mode as Rising Edge.
Fall		Set the External Trigger Mode as Falling Edge.
↗		Save all the changes and go back to last menu.

1. To run External Trigger

After setting the parameter, press **↗** to go back to last Menu and run External Trigger by pressing **Done**. Now, **Run/Hold** and **Single** on the Front Panel will be crushed out, the instrument enter into the External Trigger Mode.

2. To set Output

In External Trigger Mode, the instrument could output a pulse signal through the six pin of RS232 interface on the rear panel after finishing sampling data. By the way, the polarity and output pulse width of this signal could be adjusted.

Press **Trig** → **VMC**, the display shows:

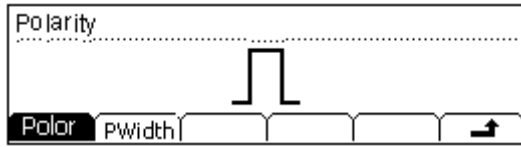

Figure 2-71 Set Output Pulse

Table 2-25 The Explanation of the External Triggering

Function Menu	Settings	Explanation
Polar	Pos Neg	Setting the pulse signal's polarity.
PWidth		Setting the pulse width.
↵		Store the changing and back to the higher menu.

The VMC function output

- At external triggering mode, when the data sampling is over, the instrument will output a pulse signal to indicate operation completed.
- At external triggering mode, when P/F operating is ON, the instrument will export a pulse signal to indicate out of limitation.

Store and Recall

The Storage and Recall function enables users to save, load, and delete the instrument parameter and data files in the local storage as well as in USB storage.



Press  key, the display shows:



Figure 2-72 Store and Recall Interface

Table 2-26 Storage and Recall Function Menu Description

Function Menu	Settings	Description
Disk	C:\ A:\	Choose internal (C:\) or external (A:\) storage.
Type	MIRR_CFG Sys Setting Meas Data MEAS_CSV Sensor Sensor Data	Choose the type of the files. (MIRR_CFG and MEAS_CSV should be stored to external storage).
Read		Load the selected file.
Save		Save the file to the specified location.
Erase		Delete the selected file.
		Save all changes, back to a higher level menu.

1. Choose the file location

Select local (C: \) or USB flash device (A: \) position to store files by switching **Disk** menu continuously.

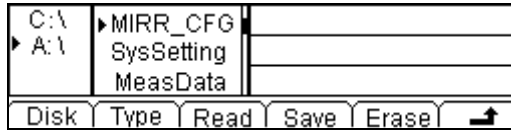

Figure 2-73 USB flash device storage Interface



NOTE: When storage the files to A-Disc, Please do not remove the USB flash device.

2. Choose the storage type of the files



Choose the type of files that required to operation by Switching **Type** menu continuously, which includes: MIRR_CFG, SysSetting, MeasData, MEAS_CSV, Sensor and SensorData. Such as to select **MeasData** to enter the following interface:



Figure 2-74 Select File type

Press **Type** to switch file type to read or save corresponding files.

3. File Operation

Use  and  buttons on the front panel to select file storage position among File1 to File10, then, press **Read**, **Save** and **Erase** buttons to do the corresponding operation. Press **Save** to enter the following interface.

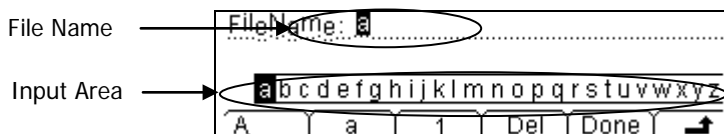

Figure 2-75 Input File Name

File Name Input Method:

1. Use the up/down direction keys to select the File Name or Input Area, and the operation area could be signed by black shading.
2. Use the left/right direction keys to move the cursor to the position (File Name Area) or character (Input Area).
3. Press **A**, **a** and **1** to select the Capital letter, Lowercase letter or Numbers.
4. The **Del** function can only delete the letter on which the cursor taking place.
5. Press **Done** to save current file.

To Set Up the Utility

The Utility function establishes system parameters, interface parameters, and calibration.



Figure 2-76 Setting Interface

Table 2-27 Utility Function Menu Description

Function Menu	Settings	Function Menu
Cmd		To choose the commands
I/O		To set up I/O and LAN parameters.
System		To set up system information configuration.
T/C		Test and calibration function.
Print		Open/Close pint function.
↗		Save all the changes to end current operation

Commands

The multimeter is compatible with three types of commands which are Rigol DM3058 commands, Agilent 34401A Commands and Fluke 45 Commands. Rigol Commands is the default.

Press  → **Cmd** to enter the following interface to choose needed Commands.

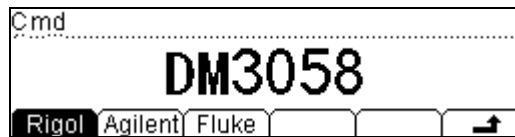



Figure 2-77 Selection Interface

I/O Settings

Press  → I/O, the display shows:

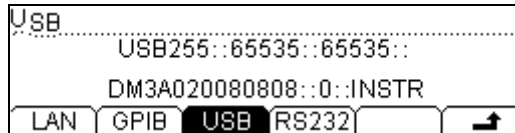



Figure 2-78 Interface Setting

Table 2-28 I/O Setting Function Menu Description

Function Menu	Settings	Description
LAN*		Set up LAN interface.
GPIB*		Set up GPIB I/O interface. The bound of value is 0~30.
USB		Check USB interface ID.
RS232		Set up RS-232 I/O interface.
		Save all changes, back to a higher level menu.

Operation introduction:

- Remote control through GPIB (IEEE-488)*, USB, RS-232 or LAN* interface can be configured.
- Each time, only one of the GPIB, USB and RS-232 interfaces can be enabled.

Note*: only for DM3058.

1. Set Up LAN Parameter (only for DM3058)

Follow the procedures to set up a LAN configuration and remote interface from the Front Panel.

Press  → I/O → LAN, the display shows:

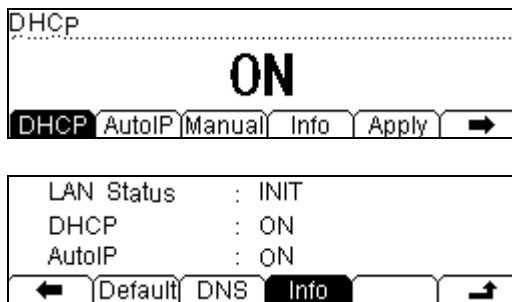

Figure 2-79 LAN Settings

Table 2-29 LAN Parameter Function Menu Description

Function Menu	Settings	Description
DHCP		Open or Close DHCP.
Auto IP		IP address will be set from 169.254.0.1 to 169.254.255.254 automatically, and Subnet Mask will be 255.255.0.0.
Manual IP		Set IP address, Mask and Gateway manually.
Info		View MAC address and other parameters.
Apply		Apply current LAN settings.
Default		Resume default settings.
DNS		Set DNS server address.
↗		Save all changes, back to a higher level menu.

Settings of the IP address have three methods which can be sorted by priority: DHCP, Auto IP and Manual IP.

- To use DHCP, turn "ON" DHCP;
- To use Auto IP, turn "OFF" DHCP and select Auto IP;
- To use Manual IP, turn "OFF" DHCP and select Manual IP to set the IP address manually, see the figure below.

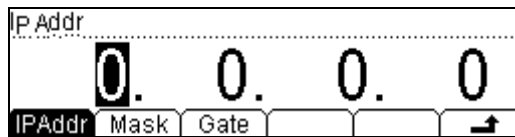

Figure 2-80 Manual IP Setting

Table 2-30 IP Setting Menu Description

Function Menu	Settings	Description
IPAddr		Setup IP address.
Mask		Setup Subnet Mask.
Gate		Setup default Gateway.
↗		Save all the changes and go back to last Menu.

2. Set Up GPIB Parameter (only for DM3058)

Each device on the GPIB (IEEE-488) interface must have a unique address. You can set the address of multimeter to any integral value between 0 and 30. The default address is "7" when the instrument is shipped from the factory.

Press **Utility** → **I/O** → **GPIB**, enter the menu shown below:

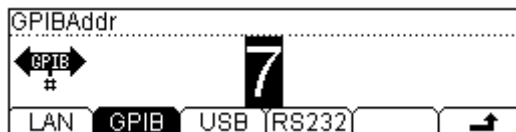



Figure 2-81 GPIB Setting

3. Set Up RS-232 Parameters

Choose RS-232 (serial data interface) interface. Properly configure the baud rate and parity to make parameters the same as that settled in your computer. Make sure the connection line is unbroken. The configuration is saved in non-volatile memory and shown in the following menu.

Press  → I/O → RS232, enter the menu shown below:

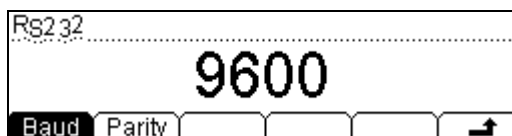



Figure 2-82 RS-232

Table 2-31 RS-232 Parameter Function Menu Explanation

Function Menu	Settings	Explanation
Baud	1200 2400 4800 9600 19200 38400 57600 115200	Set RS-232 baud rate
Parity	None Odd Even	The parity check include: None, Odd check, and Even check.
		Save all changes, back to a higher level menu.

Baud rate:

Properly configure the baud rate to make parameters the same as that settled in your computer.

Available baud rate values are 1200, 2400, 4800, 9600, 19200, 38400, 57600 and 115200. The default value is 9600.

Parity:

Properly configure the parity to make it the same as that settled in your computer. There are three parameters: None, Odd, Even, the default is "None". The current choice is stored in nonvolatile memory.

RIGOL

NOTE: When RS-232 interface is used, the parity of multimeter:

None parity: the digits sent by PC should be 8;

Odd/Even parity: the digits sent by PC should be 7.

System Settings

Press  → System, enter the menu shown below:



Figure 2-83 The Interface of Setting the System Function

Table 2-32 System Settings Function Menu Explanation

Function Menu	Settings	Explanation
Lang	中文简 English	Select the display interface language.
Disp	Bright Contr Invert	Set up the display.
Sound		Switch beeper sound On/Off.
Format	Deciml Separte	Set up digit display format.
Cfg	PwrOn Default Switch	Set up the power on setting. Set up the multimeter to factory setting. Enable or Disable the front power switch.

1. Select languages

The multimeter supports two kinds of languages for users.

Press  → Sys → Lang, enter the menu shown below:

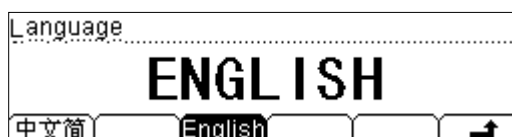

Figure 2-84 choose Language

2. Set Up the Display

Press **Utility** → **Sys** → **Disp**, enter the menu shown below:

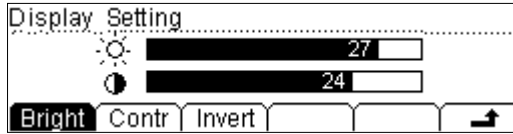

Figure 2-85 Display settings

Table 2-33 Display Settings Function Menu Explanation

Function Menu	Settings	Explanation
Bright*		Increase or decrease the display light with left and right keys.
Contr*		Increase or decrease the display contrast with left and right keys.
Invert		Set to invert display mode.
↗		Save all changes, back to a higher level menu.

NOTE*: The configuration of Bright and Contrast are saving in non-volatile memory.

3. Beeper On/Off

Press **Utility** → **Sys** → **Sound**, enter the menu shown below. Turn on /Turn off the sound of button and information cue, the sound in short circuit measure can be closed. The current choice is saved in nonvolatile memory.

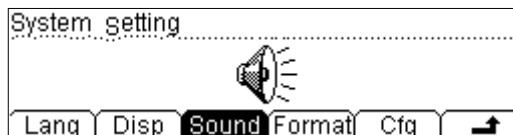



Figure 2-86 Sound settings

4. Set Number Format

Press  → System → Format to enter into following Menu to setup.

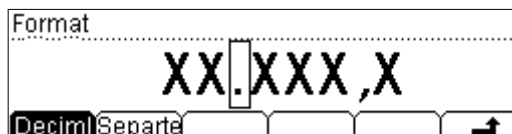



Figure 2-87 Set Number Format

Table 2-34 Function Menu for setting **Number Format**

Function Menu	Setting	Explanation
Deciml	· ,	Expresses radix point with "·" or ",".
Separte	' None Space	Expresses separator with " ' ", space or none.
		Save all the changes and go back to last Menu

Take a parameter of AC Current as example, if you select **Decimal** as "·" and **Separator** as " ' ", then it will shown according to the following format.

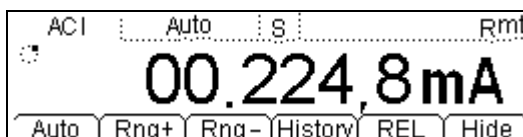

Figure 2-88 Date format

Decimal and **Separator** cannot be selected as the same format, that is if the **Decimal** is " ' ", then the **Separator** can only be selected as "·", "None" or "Space". So there are six different types of way totally to show Number Format.

5. Configuration

Press **Utility** → **System** → **Cfg** to enter into the following interface.

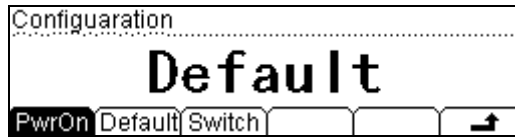

Figure 2-89 Choose power supply

(1) PwrOn

Set the Power On state of the instrument. You can choose “**Default**” or “**Last**”.

- The configuration is effective when you restart the multimeter.
- DC Voltage is always the selected function when the instrument is turned on even if you have selected “**Default**” or “**Last**” as the Power On state.

(2) Default

Press **Utility** → **System** → **Cfg** → **Default** → **Done**, and then restart the system to factory default state. The Parameter shown below:

Table 2-35 Parameter Lists of Factory Defaults:

Measurement Parameter	Factory Defaults Setting
* Continue Resistance	10Ω
Filter	OFF
DC Resistance	10MΩ
Digit Resolution	5 ½
Measurement Function	DCV
range	Auto

Math Function	Factory Defaults Setting
Math Stats	Close
Math	Statistic
Math Register	All registers cleared
* dBm Resistance	*600Ω

Trigger Parameter	Factory Defaults Setting
Interval	400ms
Samples	1
Hold	0.1%
Trigger Sources	Auto Trigger

System Operations	Factor Defaults Setting
* Sound	* Open
* Separate	“, ”
Language	English
Display	Natural model
Error queue	Errors cleared
Instrument parameter and data	No change

Interface	Factor Defaults Setting
* GPIB address (only for DM3058)	*7
* I/O	*USB
*Baud	*9600 baud
*Parity bit	* no (8 digits)

Calibration	Factor Defaults Setting
Calibration Stats	Password

NOTE*: Parameter with (*) are saved in non-volatile Reading Storage

(3) Switch

The front panel soft switch could be set to two working modes (enable or disable) to set whether the front panel power switch is valid at power-on.

Test/Cal

Press  → Cal, enter the following interface:

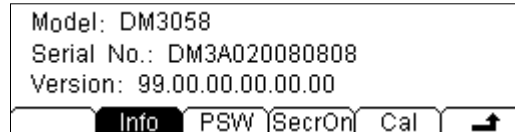



Figure 2-90 Inspective Interface

Table 2-36 Inspection Manu

Function Manue	Settings	Explanation
Info		Check relative information about the instrument
PSW		Input Adjust password
SecurOn		Open or Close Safety Lock
Cal		Calibrate every range about the instrument
		Save all the changes and go back to last Manu

NOTES:

- Safety Lock is open before inputting password.
- After input right password, Safety Lock will be open automatically.
- This instrument has been calibrated before leaving factory. To perform a calibration, please contact with the Technical Support Department of **RIGOL** for help.

Print

This function helps users to send out the measure values through RS-232 interface.

Press  → **print**, enter the following interface:

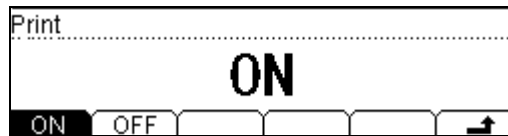



Figure 2-91 Print interface

How to Use the Built-in Help System

The built-in help system provides application description of each button on the front panel.

Press  button, the display shows below:

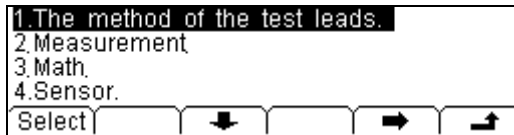









Figure 2-92 Help menu



Figure 2-93 Operation menu

Table 2-37 Help Function Menu Description

Function Menu	Settings	Description
Select		To select the help information you want.
		Move up the cursor and select the help menu.
		Move down the cursor and select the help menu.
		Enter the last page help menu.
		Enter the next page help menu.
		Back to a higher level menu.

NOTE: The arrowhead  and  are hidden before any operation is token. The method of obtaining the help of the keyword:

-
- 1. The method of the test leads**
How to connect the leads in different measurements.
 - 2. Measurement**
Getting the functions, the measurement steps and the method of adjusting the range and resolution.
 - 3. Math**
How to use the math function while you are measuring.
 - 4. Sensor measure**
How to measure with the sensor.
 - 5. Storage and recall**
How to store and read the data/parameter/ sensors/scan task.
 - 6. To set the Utility**
The method of setting the Utility.
 - 7. I/O interface**
Use method of setting the I/O interface.
 - 8. Online Help**
Press and hold the key for more than 3 seconds at any operation interface to obtain Help information of the key.
 - 9. To change the electric power fuse**
How to change the electric power fuse.
 - 10. Support**
Getting the technique support.

Chapter 3 Application Examples

- Example 1: Reading Statistic Functions
- Example 2: Elimination Leads Impedance
- Example 3: dBm Measurement
- Example 4: dB Measurement
- Example 5: P/F Test
- Example 6: Thermocouple Setting and Measurement
- Example 7: Reading Hold
- Example 8: Store and Recall the Preset
- Example 9: Mirror Image Configuration
- Example 10: To Realize Remote Control via LXI (only for DM3058)

Example 1: Reading Statistic Functions

How to realize the statistic function of maximum value for readings during measuring.

During the maximum value statistic calculation, the first reading is taken as the maximum value and being shown on the display. It will be refreshed to new maximum value sub sequentially.

Operating Steps:

1. Press $\sim V$ button, select AC Voltage measurement function. Choose an appropriate measurement range.
2. Connect test leads as Figure 2-8.
3. Set the Statistic measurement function parameters.
4. Press Math \rightarrow Stats \rightarrow MAX \rightarrow ON to statistic maximum value from the measurement result.
5. Lead test leads into the circuit and start to measure.

As shown below, current Statistic State is "MAX" and current reading is the maximum of all. See the figures below, the maximum value will refresh with sample counts.

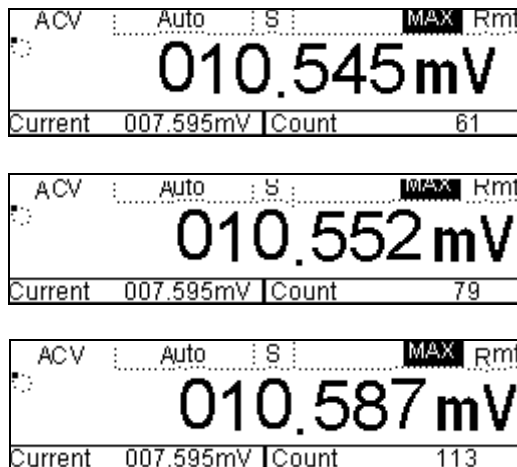

Figure 3-1 Statistic Maximum

Example 2: Elimination Leads Impedance

REL Operation could eliminate impedance errors from leads when measuring smaller resistance.

Operating Steps:

1. Press Ω button, select Resistance (2WR) measurement function.
2. Connect test leads as Figure 2-18.
3. Choose an appropriate resistance range based on the measurement range. The default is Auto Range.
4. Lead impedance will be shown on the screen as follow after connecting with two leads together.

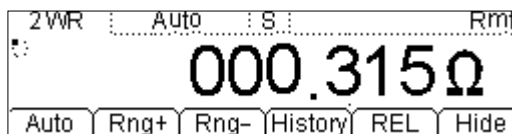

Figure 3-2 Lead impedance

5. Set parameters for Relative operation.
 - (1) Press Math → **REL** → **Current** and set the present value as current value.

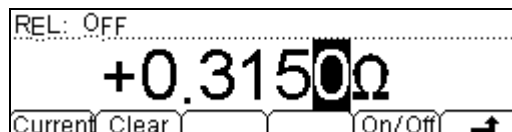

Figure 3-3 Parameter settings

- (2) Press **On/Off** to open Relative measurement function.
- (3) Press \rightarrow continuously and go back to main interface, then you will obtain final lead impedance.

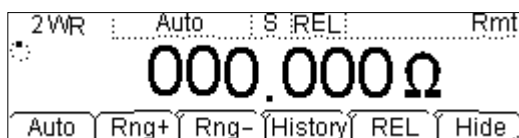

Figure 3-4 Lead impedance after operation

- (4) Besides, The **REL** on the measurement interface could also open Relative operation.

Example 3: dBm Measurement

dBm is commonly used in audio signal measurement. Next, we will show you how to measure dBm value.

Operating Steps:

1. Press $\sim V$ button to start AC Voltage Measurement and choose an appropriate voltage range.
 2. Connect test leads as Figure 2-8.
 3. Set parameters of dBm operation.
- (1) Press Math → **dBm** to set the selective value of dBm as a reference value within supposed circuit by using direction keys.

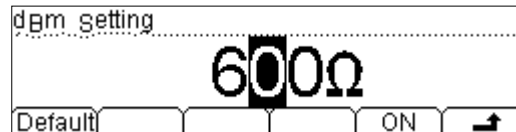

Figure 3-5

Select Reference resistance as measurement value

- (2) Press **ON** to turn on dBm measurement function. At this time, the reading shown on the screen is the Power value of reference resistance.

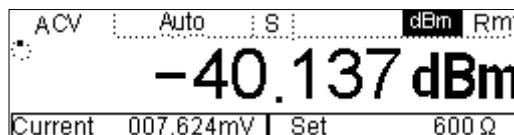

Figure 3-6 Operation result

Example 4: dB Measurement

As a common measuring unit, dB has been widely used in electrical engineering, radio science, mechanics, shock and vibration, mechanical power and acoustics areas. Next, we will show you how to measure dB between two circuits.

Operating Steps:

Method1:

Measure dBm_1 and dBm_2 existing in two circuits separately refers to Example 3, and then dB could be got:

$$\text{dB} = \text{dBm}_1 - \text{dBm}_2$$

Method2:

1. Press $\sim V$ button to start AC Voltage Measurement and choose an appropriate voltage range.
2. Connect test leads as Figure 2-8.
3. Set up dBm_2 according to Example 3.
4. Press $\text{Math} \rightarrow \text{dB}$, set parameters of dB operation (dBm_1).

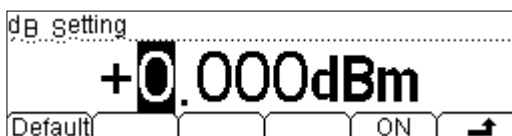

Figure 3-7 Set the set value of dB

5. Press $\text{Math} \rightarrow \text{ON}$ to open dB measurement function. At this time, the reading shown on the screen is the Power difference between two circuits.

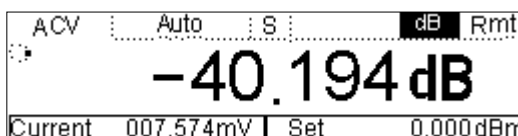

Figure 3-8 Operation result

Example 5: P/F Test

P/F Operation hints you the signal is overstep its range according to the selected High/Low Limit parameters; meanwhile the buzzer makes a sound to alarm (if Sound is open)

Operating Steps:

1. Press $\sim V$ button to start AC Voltage Measurement and choose an appropriate voltage range.
2. Connect test leads as Figure 2-8.
3. Set the High/Low Limit Value.

(1) Press **Math** → **P/F** → **High** to set the high limit value.

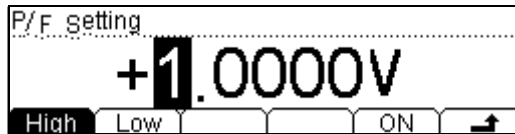

Figure 3-9 Set the High Limit Value

(2) Press **Math** → **P/F** → **Low** to set the low limit value.

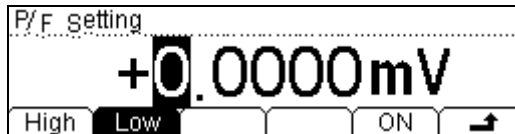

Figure 3-10 Set the Low Limit Value

(3) Press **ON** to start P/F testing. As shown in Figure 3-11, The test result is "PASS" as the measured value is between 0V and 1V.

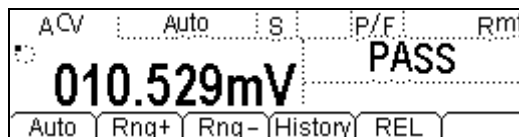

Figure 3-11 P/F Test result

Example 6: Thermocouple Setting and Measurement

Thermocouple is a common temperature sensor. Type, voltage and cold-side temperature are available for thermocouple measurement.

The instrument can measure temperature of HI and LO terminals (cold-side), and calculate absolute temperature of hot-side. Besides, only the relationship between thermocouple voltage and cold-side temperature is need to be input according thermocouple type when you set the thermocouple sensor.

Operating Steps:

About the connection of Sensor please refer to "To Measure Sensor" in chapter 2.

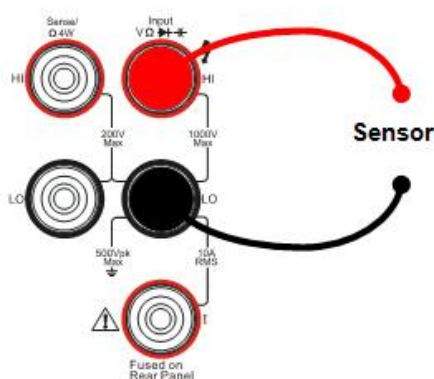

Figure 3-12 Sketch map for connecting

1. Press **Sensor** → **New** to enter into the setting interface.

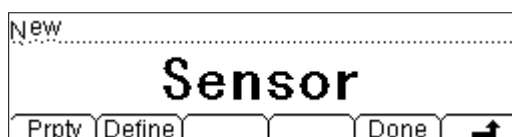

Figure 3-13 New interface

2. Press **Prpty** to enter into the edit interface of Property.

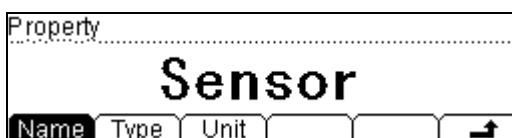

Figure 3-14 Edit interface

- (1) Press **Name** and input the name of this sensor: SensorT. Then, go back to Edit interface of Property via clicking **Done**.

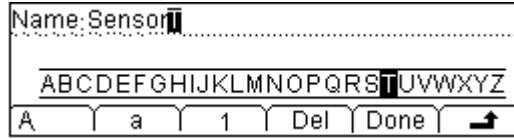

Figure 3-15 Edit interface of Name

- (2) Press **Type**, to select the type of the sensor: TC.

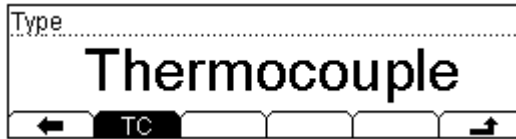

Figure 3-16 Edit interface of Type

- (3) Press **Unit** → °C, select the unit of the sensor: °C. Save and return to sensor **New** interface by pressing **Done** after property parameter input.

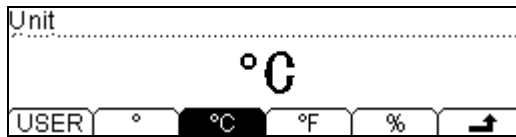

Figure 3-17 Edit interface of Unit

3. Press **Define** button, the interface shows below:

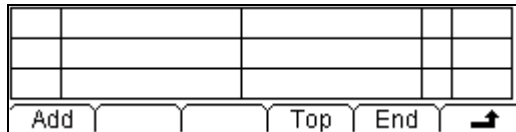

Figure 3-18 Edit interface of Reference value

4. Press **Add** button, input the first group of reference value: 1V, 1°C.

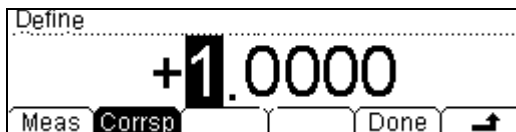

Figure 3-19 Input the first group of reference value

5. Press **Done** to get a fist group of reference value.

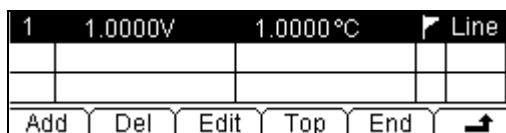

Figure 3-20 first group of reference value

6. Press **Add** button, input the second group of reference value: 2V, 2°C.

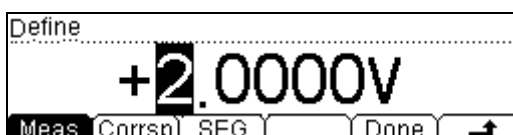

Figure 3-21

Input the second group of reference value

7. Press **Done** to save data, getting two groups of reference values.

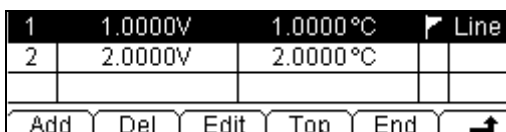

Figure 3-22 Edit interface of reference value

It allows deleting and editing the reference values that had been entered, select the group of reference value then press **Del** or **Edit** to perform the operations required. When you finish inputting all the data, press **→** and save all the changes, back to a higher level menu.

8. Press **→** → **Done** to finish sensor file edit and enter the save and apply interface.

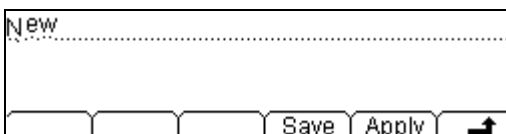

Figure 3-23 Finish interface

9. Press **Save** to load Sensor's file has been saved to the Memory of DM3058/DM3058E. For the details please refer to **Storage and Recall**.

Select **Apply** to load settings into current Sensor and use it directly.

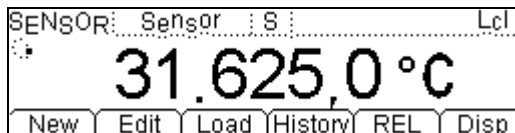

Figure 3-24 Apply interface

- 10. Press **Disp** and select Display mode of measurement result as **All** to view measurement value and its corresponding value.



Figure 3-25 measure mode

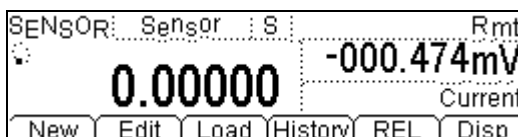



Figure 3-26 measure value

Example 7: Reading Hold

Reading Hold can help user to obtain a stable reading and hold it on the display of Front Panel. The reading would be hold all the same although testing pen had been withdrew. Then we will introduce how to keep the readings displayed on screen.

Operating Steps:

1. Press  to start DC Voltage Measurement and choose an appropriate range.
2. Connect test leads as Figure 2-5.
3. Set Parameters of Holding Trigger.
 - (1) Press  → **Auto** → **Hold** → **On/Off** → **0.1%**, Holding range: 0.1%

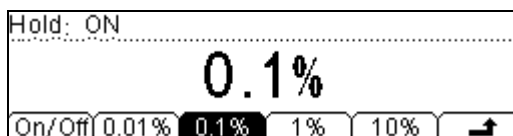





Figure 3-27 Reading holding interface

- (2) Press  to save all changes.
- (3) Reprress  to finish setting and close menu.
4. Press  two times to start Hold function.
5. Connecting test leads into circuit and start measuring.

Example 8: Store and Recall the Preset

Suppose the input power supply is AC 220V, output is DC12V, error is permitted within $\pm 0.5V$ during testing the power supply.

Operating Steps:

1. Press  and then select 750V level by **Rng+/-** or Up/Down direction keys.

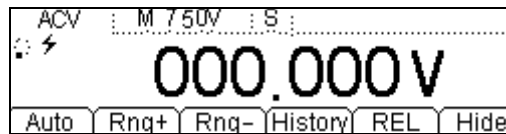



Figure 3-28 Manual measure interface

2. Save settings into Set1.

Press  to enter Preset menu as shown in the figure below.

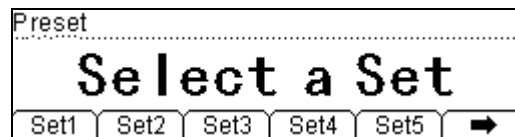



Figure 3-29 Preset menu interface

Press  → **Set1** and store these settings into the first System Configuration file, then press .

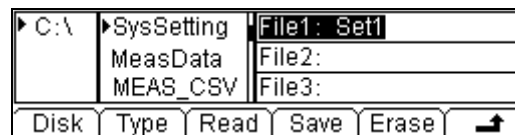



Figure 3-30 Configuration save interface

3. Press  and then select 20V level by **Rng+/-** or Up/Down direction keys to test output voltage.
4. Open **P/F** operation, set High limit as 12.5V and Low limit as 11.5V so as to test whether the output DC 12V is exceed or not.
5. Save settings in step 3&4 to Set2 by using the method shown in step 2.
Now the preset storage is finished. Press  → **Set1** or **Set2** to recall the settings when needed in later applications.

Example 9: Mirror Image Configuration

In virtue of this function, all the “System Configuration” and “Sensor Configuration” could be backup via USB flash device or clone to other DM3058/DM3058E. Up to 10 System Configuration files and 10 Sensor Configuration files could be stored in the instrument. Then, we will take an example about the storage of 2 system configuration and 2 sensor configuration files to explain in the following passage.

Operating Steps:

1. Store Configuration files “Set1” and “Set2”. The details have been mentioned in last example, please refer to.
2. Create a new Sensor Configuration file. Please refer to “Example 6”.
3. Press **Save** to store Sensor file that has been selected into the interior Memory of DM3058/DM3058E, then you will get a file named “a”. Please create another file “b” in the same way.

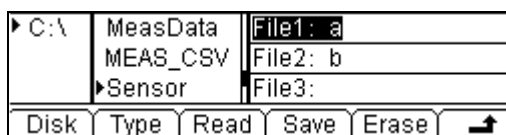

Figure 3-31 Save interface

4. Save the “System Configuration” and “Sensor Configuration” files to USB flash device in the format of “MIRR_CFG”. Insert a USB flash device; select **Location** as A:\ and **Type** as MIRR_CFG”:

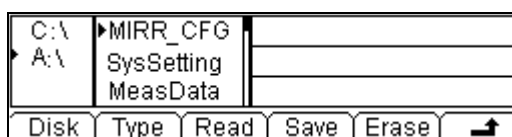

Figure 3-32 Mirror Image interface

Press **Save** and input file name as “m”, then a Mirror Image Configuration file will be obtained.



Figure 3-33 Mirror Image Configuration file

5. At present, the m.mir file contains 2 system configuration files which are "Set1" and "Set2" and 2 sensor configuration files which are "a" and "b".
 - (1) You can delete the configuration files in DM3058/DM3058E and read (Read) the m.mir file again to re-release the files to the corresponding location inside DM3058/DM3058E.
 - (2) Also, you can "clone" the configuration stored to other DM3058/DM3058E via USB flash device.

Example 10: To Realize Remote Control via LXI (only for DM3058)

Remote Control function based on LXI can help users to operate instrument remotely by internet. LAN setting offers three kinds of ways to get IP address: DHCP, Auto IP and Manual IP, which enable users into the remote control system. The detailed operation steps are given in the following part:

Operating Steps:

1. Press  → I/O → LAN → Auto IP, the instrument will get IP address automatically.

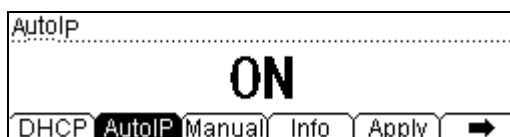



Figure 3-34 Auto IP

2. Choose **info**; view the internet setting message by  and  on the front panel.

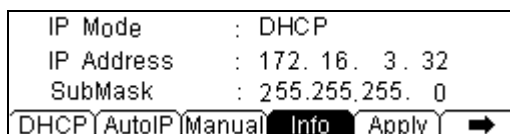

Figure 3-35 Network setting interface

3. Please input the IP address into the IE browser to open the main interface of the remote control system as shown in the figure on the next page.



Figure 3-36 Welcome page

Remote control system offers 6 kinds of operations to users. You can choose any one by the menus on left of main interface.

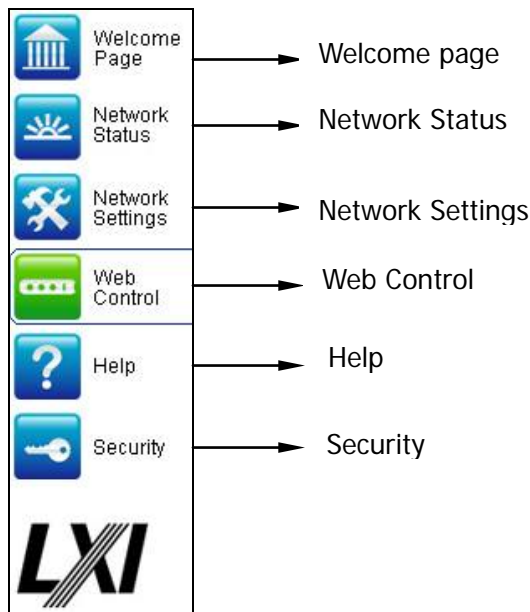

Figure 3-37 Remote control system menus

- Choose “Web control”, and then an interface will pop up as follows. You can click the buttons to control instrument remotely. If you want to exit the system, please close the web, and press local button on instrument.

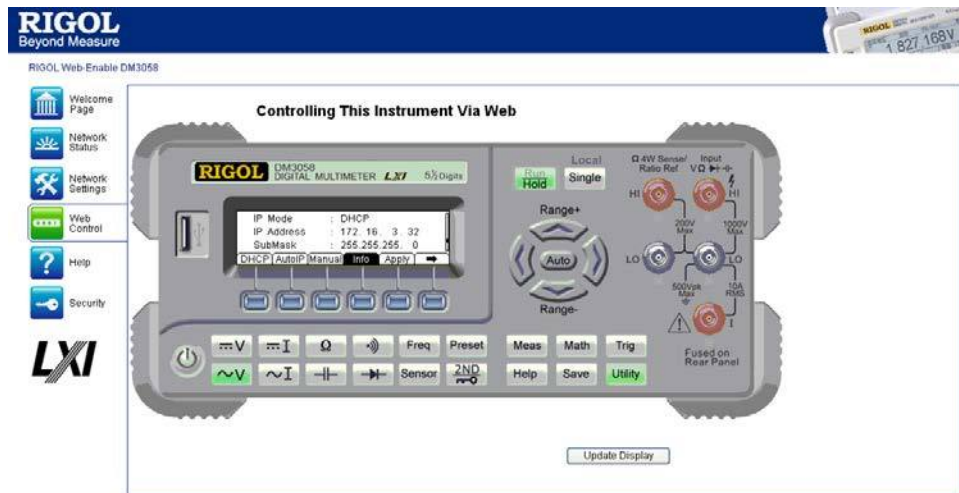

Figure 3-38 Operation interface

Chapter 4 Troubleshooting

1. When pressing the power switch, the multimeter is still in blank screen with nothing displaying:

- (1) Check if the power is correctly connected.
- (2) Check if the main power switch on the rear panel has been turn on.
- (3) Check if the safety fuse has been blown, replace with a new one if necessary.
- (4) Having done with the above steps, restart the instrument.
- (5) If it still cannot work properly, please contact the local **RIGOL** Support center, let's serve for you.

2. When connecting a current signal, the reading has no change:

- (1) Check if the test lead is correctly connected to current jack or the LO jack.
- (2) Check if the safety fuse in the current location on the rear panel has been blown.
- (3) Check if the measure location has switched to the DCI or ACI place correctly.
- (4) Check whether the input is ACI but the shelves location is DCI.

3. When connecting a DC signal, the reading display is abnormality:

- (1) Check if the test lead is correctly connected with the current jack and the LO jack.
- (2) Check if the safety fuse in the current location on the rear panel has been blown.
- (3) Check the measure location has switched to the DCI or DCV place correctly.
- (4) Check whether the input is DCI but the shelves location is ACI.

Chapter 5 Measurement Tutorial

True RMS AC Measurements

The AC measurement of DM3058/DM3058E has true RMS response. The power dissipated in a resistor within a time is proportional to the square of the measured true RMS voltage, independent of wave shape. This multimeter can accurately measure true RMS voltage or current, as long as the wave shape contains negligible energy above the multimeter's effective bandwidth. The effective AC voltage bandwidth of DM3058/DM3058E is 800kHz and the effective AC current bandwidth is 100kHz.

The multimeter's AC voltage and AC current functions measure the "AC coupled" true RMS value, that is to measure the RMS value of the AC component (DC component is rejected) of the input signal.

For sine waves, triangle waves, and square waves, the AC and AC+DC values are equal since these waveforms do not contain a DC offset. See table 5-1 below.

Table 5-1 True RMS AC Measurement of Sine, Triangle and Square waves

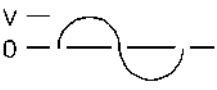
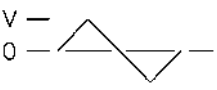
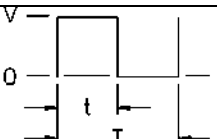
Waveform	Crest Factor (C.F.)	AC RMS	AC+DC RMS
 <p>A diagram of a sine wave. The vertical axis is labeled 'V' and '0'. The wave oscillates around the zero line.</p>	$\sqrt{2}$	$\frac{V}{\sqrt{2}}$	$\frac{V}{\sqrt{2}}$
 <p>A diagram of a triangle wave. The vertical axis is labeled 'V' and '0'. The wave oscillates around the zero line.</p>	$\sqrt{3}$	$\frac{V}{\sqrt{3}}$	$\frac{V}{\sqrt{3}}$
 <p>A diagram of a square wave. The vertical axis is labeled 'V' and '0'. The pulse width is labeled 't' and the period is labeled 'T'.</p>	$\sqrt{\frac{T}{t}}$	$\frac{V}{C.F.} \times \sqrt{1 - \left(\frac{1}{C.F.}\right)^2}$	$\frac{V}{C.F.}$

Non-symmetrical waveforms, such as pulse trains, contain DC voltages which are rejected by AC coupled true RMS measurements.

An AC coupled true RMS measurement is desirable in situations where you are measuring small AC signals in the presence of DC offsets. For example: measuring

AC ripple present on DC power supplies. There are situations, however, where you might want to know the AC+DC true RMS value. You can determine this value by combining results from DC and AC measurements as shown below. You should perform the DC measurement using 5.5 digit mode for best AC rejection.

$$RMS_{(AC+DC)} = \sqrt{AC^2 + DC^2}$$

Crest Factor Errors (non-sinusoidal inputs)

A common misconception is that "since an ac multimeter is true RMS, its sine wave accuracy specifications apply to all waveforms." Actually, the shape of the input signal can dramatically affect measurement accuracy. A common way to describe signal wave shapes is "crest factor". Crest factor is the ratio of the peak value to RMS value of a waveform.

Generally speaking, the greater the crest factor, the greater the energy contained in high frequency harmonics. All multimeters have errors that are crest factor dependent. Crest factor errors for DM3058/DM3058E are listed in the **AC Characteristics** section in chapter 6. Please note that the crest factor errors do not apply for input signals below 100Hz.

You can estimate the measurement error due to signal crest factor as shown below:

Total Error = Error (Sine wave) + Error (Crest factor) + Error (Bandwidth)

Error (Sine wave): error for sine wave as shown in chapter 6.

Error (Crest factor): crest factor additional error as shown in chapter 6.

Error (Bandwidth): estimated bandwidth error as shown below:

$$\text{Bandwidth Error} = \frac{-C.F.^2 \times F}{4\pi \times BW} \times 100\% \quad (\% \text{ reading})$$

C.F. : signal crest factor

F : fundamental frequency of pulse

BW : effective bandwidth of the multimeter

Example:

Calculate the approximate measurement error for a pulse train input with a crest factor of 2 and a fundamental frequency of 20kHz. For this example, assume the multimeter's 1-year accuracy specifications: $\pm (0.05\% \times \text{reading} + 0.03\% \times \text{range})$.

$$\begin{aligned} \text{Total Error} &= (0.05\% \times \text{reading} + 0.03\% \times \text{range}) + (0.05\% \times \text{range}) \\ &\quad + (0.8\% \times \text{reading}) \\ &= 0.85\% \times \text{reading} + 0.08\% \times \text{range} \end{aligned}$$

Loading Errors (AC Volts)

In the AC Voltage function, the input of DM3058/DM3058E appears as a $1\text{M}\Omega$ resistance in parallel with 100 pF of capacitance. The test lead that you use to connect signals to the multimeter will also add additional capacitance and loading. Table 5-2 shows the multimeter's approximate input resistance at various frequencies.

Table 5-2 Approximate input resistance at various frequencies

Input Frequency	Input Resistance
100Hz	$1\text{M}\Omega$
1kHz	$850\text{k}\Omega$
10kHz	$160\text{k}\Omega$
100kHz	$16\text{k}\Omega$

For low frequencies:

$$\text{Error (\%)} = \frac{-R_s}{R_s + 1\text{M}\Omega} \times 100\%$$

Additional error for high frequencies:

$$\text{Error (\%)} = \left[\frac{1}{\sqrt{1 + (2\pi \times F \times R_s \times C_{in})^2}} - 1 \right] \times 100\%$$

R_s : source resistance

F : input frequency

C_{in} : input capacitance (100 pF) plus test lead capacitance

Application of the Analog Filter

The analog filter of DM3058/DM3058E can be used to reduce the influence of the AC component in DC measurement. For most measurement, the filter may not require, but sometimes it can improve the DC measurement. For instance, if the DC electrical source to be measured has a big AC ripple, it can be reduced by the analog filter.

The analog filter cannot be used to filter the internal noise of the multimeter. It has no use in DCI opening measurement, DCV short measurement or in measurement of the output from a precise DC calibration instrument, on the contrary, it may lead in additional noise and a bigger reading offset. To reduce the offset, the multimeter should be cleared under the selected range and reading rate when using the analog filter. If you cannot clear the multimeter, the measured results will have errors as shown in table 5-3 and 5-4. For other ranges and reading rates, the additional error generated the filter can be omitted.

Table 5-3 Analog Filter Error in DCV measurement

Range	Reading Rate	Additional Analog Filter Error
200mV	Slow	10 μ V
	Medium	20 μ V
	Fast	20 μ V
2V	Slow	15 μ V
	Medium	20 μ V
	Fast	20 μ V
20V	Slow	0.8mV
	Medium	1mV
	Fast	1mV

Table 5-4 Analog Filter Error in DCI measurement

Range	Reading Rate	Additional Analog Filter Error
200 μ A	Slow	0.002% range
	Medium	0.005% range
	Fast	0.005% range
20mA, 2A	Slow	0.040% range
	Medium	0.060% range
	Fast	0.080% range
200mA	Slow	0.004% range
	Medium	0.010% range
	Fast	0.010% range
10A	Slow	0.008% range
	Medium	0.010% range
	Fast	0.010% range

Chapter 6 Characteristics

General Technical Characteristics

Power Supply:

AC 100V~120V, 45Hz~440Hz

AC 200V~240V, 45Hz~66Hz

Power consumption: 20VA peak value

Mechanical:

Height × Width × Depth: 107.0mm×231.6mm ×290.5mm

Weight: 2.5kg

Display:

256×64 LCD display, support dual display, menu, Chinese and English languages, operation help.

Working Environment:

Precision 0~50°C, 80% R.H. at 40°C, No coagulation

Storage Temperature: -20~70°C

Impact and Shake: According with MIL-T-28800E, III class, 5 Level (Only Sine)

Height above sea level: upper limit 3000m

Safety:

According with IEC61010-1: 2001.

Measure CAT I 1000V, CAT II 600V.

Class of pollution: 2.

Remote Interface:

GPIB (only for DM3058), 10/100Mbit LAN (only for DM3058), USB2.0 Full Speed Device & Host (support USB flash device), RS232.

Programming Language:

RIGOL DM3058 SCPI, Fluke 45, Agilent 34401A.

LXI Compatibility: LXI Class C, Version 1.1 (only for DM3058).

Warm-up Time: 30min.

Electric Technique Characteristics

DC Characteristics

Accuracy Specifications (% of reading + % of range)^[1]

Function	Range ^[2]	Test Current or Burden Voltage	1 Year 23°C±5°C	Temperature Coefficient 0 °C to 18 °C 28 °C to 55 °C
DC Voltage	200.000mV		0.015 + 0.004	0.0015+0.0005
	2.00000V		0.015 + 0.003	0.0010+0.0005
	20.0000V		0.015 + 0.004	0.0020+0.0005
	200.000V		0.015 + 0.003	0.0015+0.0005
	1000.00V ^[4]		0.015 + 0.003	0.0015+0.0005
DC Current	200.000µA	<8mV	0.055 + 0.005	0.003+0.001
	2.00000mA	<80mV	0.055 + 0.005	0.002+0.001
	20.0000mA	<0.05V	0.095 + 0.020	0.008+0.001
	200.000mA	<0.5V	0.070 + 0.008	0.005+0.001
	2.00000A	<0.1V	0.170 + 0.020	0.013+0.001
	10.0000A ^[5]	<0.3V	0.250 + 0.010	0.008+0.001
Resistance^[3]	200.000Ω	1mA	0.030 + 0.005	0.0030+0.0006
	2.00000kΩ	1mA	0.020 + 0.003	0.0030+0.0005
	20.0000kΩ	100µA	0.020 + 0.003	0.0030+0.0005
	200.000kΩ	10µA	0.020 + 0.003	0.0030+0.0005
	2.00000MΩ	1µA	0.040 + 0.004	0.0040+0.0005
	10.0000MΩ	200nA	0.250 + 0.003	0.0100+0.0005
100.000MΩ	200nA 10MΩ	1.75 + 0.004	0.2000+0.0005	
Diode Test	2.0000V ^[6]	1mA	0.05 + 0.01	0.0050+0.0005
Continuity	2000Ω	1mA	0.05 + 0.01	0.0050+0.0005

- [1] Specifications are for 30 minute warm-up, "slow" measurement rate and 18 °C ~ 28 °C calibration temperature.
- [2] 20% over range on all ranges, except DCV 1000V, ACV 750V, DCI and ACI 10A range.
- [3] Specifications are for 4-wire resistance function, or 2-wire resistance using REL operation. Without REL operation, add 0.2 Ω additional errors in 2-wire resistance function.
- [4] For each additional 1 volt over ± 500 VDC add 0.02 mV of error.
- [5] For current terminal, > 7A DC or AC RMS for 30 seconds ON and 30 seconds OFF.
- [6] Accuracy specifications are for the voltage measured at the input terminals only. 1 mA test current is typical. Variation in the current source will create some variation in the voltage drop across a diode junction.

DC Voltage

Input Resistance:	200mV and 2V range	10M Ω or >10G Ω selectable (Input signals which exceed $\pm 2.5V$ in these ranges will pass the 100k Ω (typical) clamp resistance.)
	20V, 200V and 1000V range	10M $\Omega \pm 2\%$
Input offset current:	<90pA, 25 $^{\circ}C$	
Input Protection:	1000V on all ranges	
CMRR (common mode rejection ratio):	120dB (For the 1k Ω unbalanced resistance in LO lead, maximum $\pm 500VDC$).	
NMRR (normal mode rejection ratio):	60dB at "slow" measurement rate Add 20dB when open the "AC filter" (Settling time adds 0.35s (source impedance near zero))	

Resistance

Measurement Method:	Selectable 4-wire or 2-wire. Current source referenced to LO input.
Open-circuit Voltage:	Limit in <8V.
Max. Lead Resistance:	10% of range per lead for 200 Ω , 1k Ω per lead (4-wire ohms) on all other ranges.
Input Protection:	1000V on all ranges.

DC Current

Shunt Resistor:	200 μA sampling voltage <8mV 2mA sampling voltage <80mV 1 Ω for 20mA, 200mA 0.01 Ω for 2A, 10A
Input Protection:	Externally accessible 10A, 250V fast-melt fuse Internal 12A, 250V slow-melt fuse

Continuity / Diode Test

Measurement Method:	1mA $\pm 5\%$ current source, <8V open-circuit voltage
Response Time:	123 samples / sec, with beeper
Continuity Threshold:	Adjustable from 1 Ω to 2000 Ω
Input Protection:	1000V

Setting time attentions:

Settling time in voltage measurement is affected by the source impedance, media characteristics of the cable and input signals.

AC Characteristics

Accuracy Specifications (% of reading + % of range)^[1]

Function	Range ^[2]	Frequency Range	1 Year 23°C±5°C	Temperature Coefficient 0 °C to 18 °C 28 °C to 55 °C
True RMS AC Voltage ^[3]	200.000mV	20Hz - 45Hz	1.5 + 0.10	0.01+0.005
		45Hz - 20kHz	0.2 + 0.05	0.01+0.005
		20kHz - 50kHz	1.0 + 0.05	0.01+0.005
		50kHz - 100kHz	3.0 + 0.05	0.05+0.010
	2.00000V	20Hz - 45Hz	1.5 + 0.10	0.01+0.005
		45Hz - 20kHz	0.2 + 0.05	0.01+0.005
		20kHz - 50kHz	1.0 + 0.05	0.01+0.005
		50kHz - 100kHz	3.0 + 0.05	0.05+0.010
	20.0000V	20Hz - 45Hz	1.5 + 0.10	0.01+0.005
		45Hz - 20kHz	0.2 + 0.05	0.01+0.005
		20kHz - 50kHz	1.0 + 0.05	0.01+0.005
		50kHz - 100kHz	3.0 + 0.05	0.05+0.010
	200.000V	20Hz - 45Hz	1.5 + 0.10	0.01+0.005
		45Hz - 20kHz	0.2 + 0.05	0.01+0.005
		20kHz - 50kHz	1.0 + 0.05	0.01+0.005
		50kHz - 100kHz	3.0 + 0.05	0.05+0.010
	750.000V	20Hz - 45Hz	1.5 + 0.10	0.01+0.005
		45Hz - 20kHz	0.2 + 0.05	0.01+0.005
		20kHz - 50kHz	1.0 + 0.05	0.01+0.005
		50kHz - 100kHz	3.0 + 0.05	0.05+0.010
True RMS AC Current ^[4]	20.0000mA	20Hz-45Hz	1.5 + 0.10	0.015+0.015
		45Hz-2kHz	0.50 + 0.10	0.015+0.006
		2kHz-10kHz	2.50 + 0.20	0.015+0.006
	200.000mA	20Hz-45Hz	1.50 + 0.10	0.015+0.005
		45Hz-2kHz	0.30 + 0.10	0.015+0.005
		2kHz-10kHz	2.50 + 0.20	0.015+0.005
	2.00000A	20Hz-45Hz	1.50 + 0.20	0.015+0.005
		45Hz-2kHz	0.50 + 0.20	0.015+0.005
		2kHz-10kHz	2.50 + 0.20	0.015+0.005
	10.0000A ^[5]	20Hz-45Hz	1.50 + 0.15	0.015+0.005
		45Hz-2kHz	0.50 + 0.15	0.015+0.005
		2kHz-5kHz	2.50 + 0.20	0.015+0.005

Additional wave crest factor error (not Sine)^[6]

Wave crest coefficient	Error (% range)
1 - 2	0.05
2 - 3	0.2

- [1] Specifications are for 30 minute warm-up, "slow" measurement rate and 18°C - 28°C calibration temperature.
- [2] 20% over range on all ranges, except DCV 1000V, ACV 750V, DCI and ACI 10A range.
- [3] Specifications are for sine wave input >5% of range. 750V range is limited to 8×10^7 Volt-Hz. For inputs from 1% to 5% of range and <50 kHz, add 0.1% of range additional error. For 50 kHz to 100 kHz, add 0.13% of range.
- [4] Specifications are for sine wave input >5% of range. Add 0.1% of the range for the sine wave input is 1%–5% of the range.
- [5] For continuous current which is higher than DC 7A or AC RMS 7A, disconnecting for 30s after 30s connection.
- [6] For frequency <100 kHz. Please refer to the "*Crest Factor Errors (non-sinusoidal inputs)*" section described on Page 5-3 for bandwidth error of other frequency.

True RMS AC Voltage

Measurement Method:	AC coupled true-RMS-measure, the DC component of input with up to 1000V on any range.
Crest factor:	Crest factor on full range ≤ 3
Input Impedance:	$1\text{M}\Omega \pm 2\%$ in parallel with 100pF on any ranges
Input Protection:	750Vrms on all ranges
AC filter bandwidth:	20Hz~100kHz
CMRR (common mode rejection ratio):	60dB (For the $1\text{k}\Omega$ unbalanced resistance in LO lead and <60Hz, maximum $\pm 500\text{VDC}$).

True RMS AC Current

Measurement Method:	DC coupled to the fuse and shunt. AC coupled true RMS measurement (measures the ac component only)
Crest factor:	Crest factor on full range ≤ 3
Max. Input:	The DC + AC current peak value <300% of the range. The RMS current including DC current is <10A.
Shunt Resistor:	0.01Ω for 2A, 10A 1Ω for 20mA, 200mA
Input Protection:	Externally accessible 10A, 250V fast-melt fuse Internal 12A, 250V slow-melt fuse

Setting time attentions:

Make sure the RC circuit of input terminal has been completely stable (up to 1s) before accurate measurement.

Input >300Vrms (or >5Arms) will cause the self heating of the signal conditioning component to

RIGOL

generate error, this error is included in the characteristics of the instrument. Internal temperature variation results from the self heating will cause additional error on ac range, this error is lower than 0.02% reading, and it will disappear after a few minutes.

Frequency/Period Characteristics

Accuracy Specifications (% of reading + % of range)^[1]

Function	Range	Frequency Range	1 Year 23°C±5°C	Temperature Coefficient 0 °C to 18 °C 28 °C to 55 °C
Frequency Period	200mV to 750V ^[2]	20Hz-2kHz	0.01+0.003	0.002+0.001
		2kHz-20kHz	0.01+0.003	0.002+0.001
		20kHz-200kHz	0.01+0.003	0.002+0.001
		200kHz-1MHz	0.01+0.006	0.002+0.002
	20mA to 10A ^[3]	20Hz-2kHz	0.01+0.003	0.002+0.001
		2kHz-10kHz	0.01+0.003	0.002+0.001

[1] Specifications are for 30 minute warm-up.

[2] Unless otherwise noted, for frequency ≤100 kHz, the specifications are for AC input voltage of 15% to 120% of range. For frequency >100 kHz, the specifications are for AC input voltage of 40% to 120% of range. 750 V range is limited to 750Vrms. 200 mV range is full range input or input that is larger than the full range. For 30 mV to 200 mV inputs, multiply % of reading error by 10.

[3] Unless otherwise noted, the specifications are for AC input current from 15% to 120% of range except where noted. 20mA range specifications are for full scale. For inputs from 5mA to 20mA, multiply total % of reading error by 10. 10A range is for AC input current from 25% to 100% of range.

Measurement Characteristics

Frequency and Period

Measurement Method: Reciprocal-counting technique. AC-coupled input using the ac voltage or ac current measurement function.

Measurement attentions:

All frequency counters are susceptible to error when measuring low-voltage, low-frequency signals. Shielding inputs from external noise pickup is critical for minimizing measurement errors.

Setting time attentions:

Errors will occur when attempting to measure the frequency or period of an input following a dc offset voltage change. The input blocking RC time constant must be allowed to fully settle (up to 1 sec) before the most accurate measurements are possible.

Capacitance Characteristics

Accuracy Specifications (% of reading + % of range)^[1,2]

Function	Range ^[2]	Test Current	1 Year 23°C±5°C	Temperature Coefficient 0 °C to 18 °C 28 °C to 55 °C
Capacitance	2.000nF	200nA	3 + 1.0	0.08+0.002
	20.00nF	200nA	1 + 0.5	0.02+0.001
	200.0nF	2µA	1 + 0.5	0.02+0.001
	2.000µF	10µA	1 + 0.5	0.02+0.001
	200µF	100µA	1 + 0.5	0.02+0.001
	10000µF	1mA	2 + 0.5	0.02+0.001

NOTE:

- [1] Specifications are for 30 minute warm-up using REL operation. Additional errors may occur for non-film capacitors.
- [2] Specifications are for 1% to 110% of range on 2 nF range and 10% to 110% of range on all other ranges.

Measurement Characteristics

Capacitance

Measurement Method: Current input with measurement of resulting ramp.

Connection Type: 2-wire

Input Protection: 1000V on all ranges

Measurement attentions:

Measurement of small capacitance is easily affected by external noise thus to cause measurement error, disable input will reduce this error.

Other Measurement Characteristics

Triggering and Memory

Samples per Trigger:	1 to 2,000
Trigger Delay:	8ms to 2000ms
External trigger input:	
Input Level:	TTL compatible (High level when left trigger input open)
Trigger Condition:	Selectable Rising/Falling edges.
Input Impedance:	>20k Ω , in parallel with 400pF, DC-coupled
Min Pulse Width:	500 μ s
VMC Output:	
Electric Level:	TTL compensate (Input \geq 1k Ω load)
Output polarity:	positive, negative(selectable)
Output impedance:	200 Ω , typical

Arbitrary sensor measurement

Support thermocouple, DC voltage, DC current, resistance (2-wire or 4-wire), capacitance and frequency output type sensors. Build in thermocouple cold side compensate.

Cold junction compensation: $\pm 3^{\circ}\text{C}$.

Preset ITS-90 transform of B, E, J, K, N, R, S and T thermocouple and transform of platinum Pt100, Pt385 resistance temperature sensor.

Math function

Pass/Fail, RELative, Maximum/Minimum/Average, dBm, dB, Hold, Histogram, standard deviation.

History function

Volatile Memory: 2000 reading history record.

Nonvolatile Memory:

10 groups history data storage (2000 readings/group)

10 groups sensor data storage (1000 readings/group)

10 groups instrument settings storage

10 groups sensor settings storage

Support USB flash device external storage extend

Chapter 7 Appendix

Appendix A: DM3058/DM3058E Accessories

Standard Accessories:

- A Power Cord that fits the standard of destination country.
- Two test leads (black and red)
- Two Alligator Clips (black and red)
- An USB Data Wire
- Two backup fuses
- A Quick Guide
- A CD-ROM (User's Guide and Application software)

Choice Accessories:

- Kelvin Test Clip
- RS232 Cable

NOTE:

- To avoid affecting the product performance, the length of USB data wire, LAN Cable and RS232 Cable connected to the instrument should be less than 3m.
- All the accessories are available by contacting your local **RIGOL** office.

Appendix B: Warranty

RIGOL warrants that the products that it manufactures and sells will be free from defects in materials and workmanship for a period of three (3) years from the date of shipment from an authorized **RIGOL** distributor. If a product proves defective within the respective period, **RIGOL** will provide repair or replacement as described in the complete warranty statement.

To arrange for service or obtain a copy of the complete warranty statement, please contact your nearest **RIGOL** sales and service office.

RIGOL do not provide any other warranty items except the one being provided by this summary and the warranty statement. The warranty items include but not being subjected to the hint guarantee items related to tradable characteristic and any particular purpose.

RIGOL will not take any responsibility in cases regarding to indirect, particular and ensuing damage.

Appendix C: General Care and Cleaning

General Maintenance

Do not store or leave the instrument in where the instrument will be exposed to direct sunlight for long periods of time.

Caution

To avoid damages to the instrument, do not expose them to liquids which have causticity.

Cleaning

Clean the instrument often based on its operating conditions requirement. To clean the exterior surface, perform the following steps:

1. Disconnect the instrument from all power sources.
2. Clean the loose dust on the outside of the instrument with a lint- free cloth (with a mild detergent and water). When clean the LCD, take care to avoid scarifying it.



WARNING: To avoid injury resulting from short circuit, make sure the instrument is completely dry before reconnecting into a power source.

Appendix D: Contact Us

If you have any problem or requirement when using our products or this manual, please contact RIGOL Technologies, Inc.

E-mail: service@rigol.com

Website: www.rigol.com