

Table of Contents

1	Introduction	5
2	Safety Measures	6
	2.1	Definition of signal warnings and symbols 6
	2.2	Product specific safety notes 6
3	Design and Function	9
	3.1	Overview 9
	3.2	Sensor connections 9
	3.3	T-Pad and hard keys 9
	3.4	Interface connection 11
	3.5	Display icons 11
	3.6	LED 13
	3.7	Acoustic signal 13
4	Putting into Operation	14
	4.1	Scope of delivery 14
	4.2	Installing the batteries 15
	4.3	Installing power supply 16
	4.4	Connecting sensors 17
	4.5	Installing optional equipment 18
	4.5.1	Electrode holder 18
	4.5.2	Meter base stabilizing unit 18
	4.5.3	Wrist strap 19
	4.6	Switching the instrument on and off 20
5	Instrument Setup	21
	5.1	Data storage 21
	5.1.1	Storage mode 21
	5.1.2	Storage destination 21
	5.2	System settings 22
	5.2.1	Language 22
	5.2.2	Time and date 22
	5.2.3	Access control 22
	5.2.4	Sounds and visuals 23
	5.2.5	User modes 23
	5.2.6	Power management 24
	5.3	Factory reset 24
	5.4	Instrument self-test 24
6	pH/Ion Settings	25
	6.1	Calibration settings 26
	6.1.1	Buffer Group/Standard 26
	6.1.1.1	Predefined groups 26
	6.1.1.2	Customized group 27
	6.1.1.3	Ion-standard 28
	6.1.2	Calibration mode 29
	6.1.3	Calibration reminder 29
	6.2	Measurement settings 30
	6.2.1	Resolution 30
	6.2.2	Stability criterion 30
	6.2.3	Ion measurement unit 30

	6.2.4	Ion type	31
	6.2.5	Rel. mV offset	32
	6.3	Endpoint type	33
	6.4	Interval readings	33
	6.5	Temperature settings	34
	6.6	Measurement limits	34
7	IDs		35
	7.1	Sample ID	35
	7.2	User ID	35
	7.3	Sensor ID	36
8	Sensor Calibration		37
	8.1	Performing a 1-point calibration	37
	8.2	Performing a 2-point calibration	37
	8.3	Performing a 3-, 4- or 5-point calibration	37
9	Sample Measurement		38
	9.1	Selecting a measurement unit	38
	9.2	Performing a pH measurement	38
	9.3	Performing a mV or rel. mV measurement	39
	9.4	Performing an ion measurement	40
10	Data Management		41
	10.1	Data menu structure	41
	10.2	Measurement data	41
	10.3	Calibration data	42
	10.4	ISM data	42
	10.5	Data export to PC	43
11	Maintenance		44
	11.1	Electrode maintenance	44
	11.2	Software update	44
	11.3	Repair of the instrument	44
	11.4	Disposal	44
12	Technical Data		45
13	Product Portfolio		47
	13.1	Meter and kit versions	47
	13.2	Accessories	47
14	Appendix		49
	14.1	Buffers	49

1 Introduction

Thank you for purchasing this high quality METTLER TOLEDO portable meter. Everywhere you measure pH, conductivity or dissolved oxygen - the Seven2Go™ portables are designed to offer you fast quality data, one-handed operation and an investment that lasts. Whether you work in the laboratory, at-line or outdoors, the Seven2Go™ meters will provide you with high quality measurement everywhere you go. The Seven2Go™ offers many exciting features, including:

- Simple and intuitive menus that shorten steps needed for setting up measurements and calibration
- T-pad hard keys for comfortable and fast navigation
- Rubber side-guards for comfortable, one-handed operation
- IP67 rating for the entire measurement system, including meter, sensor and the connection cables
- Useful accessories such as the electrode clip, the meter base stabilizing unit, the wrist strap and the uGo™ carrying case with hermetically sealed interior for easy cleaning

2 Safety Measures

2.1 Definition of signal warnings and symbols

Safety notes are marked with signal words and warning symbols. These show safety issues and warnings. Ignoring the safety notes may lead to personal injury, damage to the instrument, malfunctions and false results.

Signal words

WARNING	for a hazardous situation with medium risk, possibly resulting in severe injuries or death if not avoided.
CAUTION	for a hazardous situation with low risk, resulting in damage to the device or the property or in loss of data, or minor or medium injuries if not avoided.
Attention	(no symbol) for important information about the product.
Note	(no symbol) for useful information about the product.

Warning symbols



General hazard



Toxic substance



Inflammable or explosive substance

2.2 Product specific safety notes

Your instrument represents state-of-the-art technology and complies with all recognized safety rules, however, certain hazards may arise in extraneous circumstances. Do not open the housing of the instrument; it does not contain any parts that can be maintained, repaired or replaced by the user. If you ever have problems with your instrument, contact your authorized METTLER TOLEDO dealer or service representative.

Intended use



This instrument is designed for a wide range of applications in various areas and is suitable for measuring pH (S2, S8), conductivity (S3, S7) or dissolved oxygen (S4, S9).

The use therefore requires knowledge and experience in working with toxic and caustic substances as well as knowledge and experience working with application-specific reagents, which may be toxic or hazardous.

The manufacturer shall not be held liable for any damage resulting from incorrect usage divergent to the operating instructions. Furthermore, the manufacturer's technical specifications and limits must be adhered to at all times and in no way exceeded.

Location



The instrument has been developed for indoor and outdoor operation and may not be used in explosive environments.

Use the instrument in a location which is suitable for the operation, protected from direct sunlight and corrosive gases. Avoid powerful vibrations, excessive temperature fluctuations and temperatures below 0 °C and above 40 °C.

Protective Clothing

It is advisable to wear protective clothing in the laboratory when working with hazardous or toxic substances.



A lab coat should be worn.



Suitable eye protection such as goggles should be worn.



Use appropriate gloves when handling chemicals or hazardous substances, checking their integrity before use.

Safety notes



WARNING

Chemicals

All relevant safety measures are to be observed when working with chemicals.

- a) Set up the instrument in a well-ventilated location.
 - b) Any spills should be wiped off immediately.
 - c) When using chemicals and solvents, comply with the instructions of the producer and the general lab safety rules.
-



WARNING

Flammable solvents

All relevant safety measures must be observed when working with flammable solvents and chemicals.

- a) Keep all sources of flame away from the workplace.
 - b) When using chemicals and solvents, comply with the instructions of the producer and the general lab safety rules.
-

FCC Rules

This device complies with Part 15 of the FCC Rules and Radio Interference Requirements of the Canadian Department of Communications. Operation is subject to the following conditions: (1) this device may not cause harmful interference, and (2) this device must accept any interference received, including interference that may cause undesired operation.

This equipment has been tested and found to comply with the limits for a Class A digital device, pursuant to Part 15 of the FCC rules. These limits are designed to provide reasonable protection against harmful interference when the equipment is operated in a commercial environment. This equipment generates, uses, and can radiate radio frequency energy and, if not installed and used in accordance with the instruction manual, may cause harmful interference to radio communications. Operation of this equipment in a residential area is likely to cause harmful interference in which case the user will be required to correct the interference at his own expense.

3 Design and Function

3.1 Overview

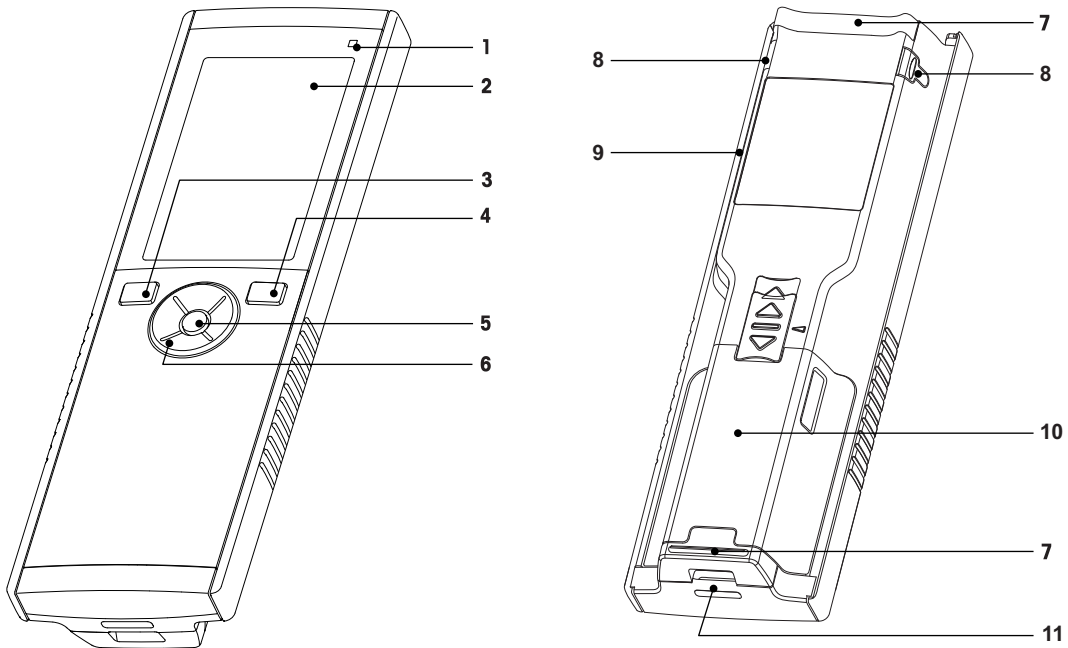

- | | |
|---|---|
| <ul style="list-style-type: none"> 1 Status LED (only Pro-series) 2 Display 3 Calibration key 4 On/Off key 5 Read key 6 T-Pad | <ul style="list-style-type: none"> 7 Rubber feet 8 Fixing points for electrode holder 9 Micro-USB port (only Pro-series) 10 Battery compartment 11 Slot for wrist strap |
|---|---|

3.2 Sensor connections

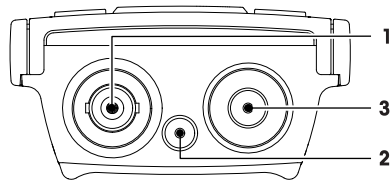



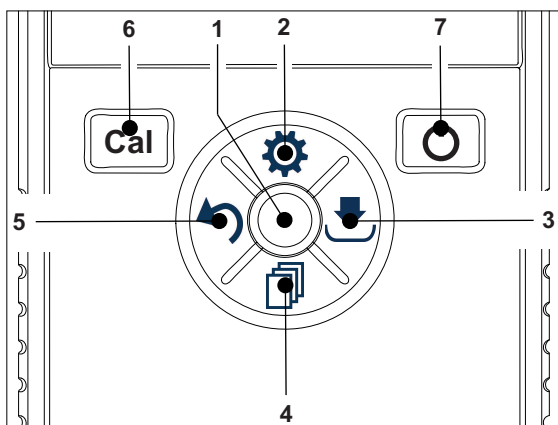

- 1** BNC socket for mV/pH signal input
- 2** Socket for reference electrode (2 mm banana)
- 3** RCA (Cinch) socket for temperature input





3.3 T-Pad and hard keys







In Standard Screen

	Key	Press and Release	Press and hold
1	Read	Start and manually stop a measurement	Activate/Deactivate uFocus™
2	Settings/Up 	Open setup menu	---
3	Store/Right 	Save last measurement data	---
4	Mode/Down 	Switch measurement mode	---
5	Recall/Left 	Recall measurement data	---
6	Cal	Start calibration	Recall last calibration result
7	On/Off 	---	Switch instrument on (hold for 1 second) or off (hold for 3 seconds)

In calibration mode (indicated by)

	Key	Press and Release	Press and hold
1	Read	Manually stop calibration Save calibration result Exit calibration mode	Activate/Deactivate uFocus™
2	Settings/Up 	---	---
3	Store / Right 	---	---
4	Mode/Down 	---	---
5	Recall/Left 	---	Discard calibration result
6	Cal	---	---
7	On/Off 	---	---

Settings and data menu

	Key	Press and release	Press and hold
1	Read	Select submenu Confirm setting	Exit menu
2	Settings / Up 	Edit value (increase) Navigate between menu points	Fast value increase
3	Store / Right 	Navigate between menu tabs (only in top level per tab)	---
4	Mode / Down 	Edit value (decrease) Navigate between menu points	Fast value decrease
5	Recall / Left 	Navigate between menu tabs (only in top level per tab) One level up (if not in top level) Move left (in input fields)	One level up (if entering value into input field)
6	Cal	---	---
7	On / Off 	---	---

3.4 Interface connection

The Micro-USB interface can be used for data transfer to a connected PC (LabX direct software) and for external power supply. It is not possible to charge the batteries.

- 1 Micro-USB port

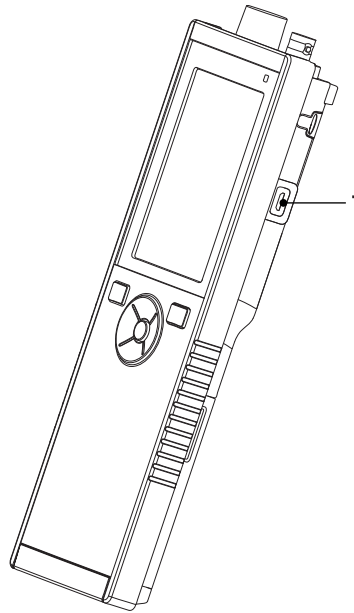









See also

- Installing power supply (page 16)

3.5 Display icons

Icon	Description
	Power status <ul style="list-style-type: none"> ■ 100% (fully charged) ■ 75% ■ 50% ■ 25% ■ 0% (fully discharged) ⚡ External power supply connected (USB)
	USB-PC connection: LabX@direct
	User mode <ul style="list-style-type: none"> Ⓜ Routine Ⓜ Expert Ⓜ Outdoor
	Storage mode <ul style="list-style-type: none"> Ⓜ Automatic Ⓜ Manual
	Interval Reading is on
	GLP format is used
	ISM sensor has been detected and is properly connected

Icon	Description
	Sensor state <input checked="" type="checkbox"/> Slope: 95-105% / Offset: \pm 0-20 mV (Electrode in good condition) <input checked="" type="checkbox"/> Slope: 90-94% / Offset: \pm 20-35 mV (Electrode needs cleaning) <input checked="" type="checkbox"/> Slope: 85-89% / Offset: > 35 mV (Electrode is faulty) <input type="checkbox"/> Slope: <85% or >105% (Electrode is defect)
	Warning / Error occurred
	Sample ID
	Buffer Group
	User ID
	Sensor ID
	Endpoint type <input checked="" type="checkbox"/> Automatic <input type="checkbox"/> Timed <input type="checkbox"/> Manual
	Endpoint criteria <input type="radio"/> fast <input type="radio"/> normal <input checked="" type="radio"/> strict
	Wait icon

3.6 LED

To use the LED, it has to be enabled in the instrument setup, see section Sounds and visuals (page 23). The LED indicates different information of the device:

- Alarm Messages
- Measurement endpoint
- System Info

Instrument State	LED green	LED red	LED orange	Meaning
Instrument turn ON	On for 5 s			<ul style="list-style-type: none"> • Instrument boot up
		Blinking		<ul style="list-style-type: none"> • Instrument has failed to boot correctly or failure after booting • Error message appears
Instrument running without calibration or measurement in progress		Blinking		<ul style="list-style-type: none"> • Calibration has expired and user has defined instrument to be blocked if sensor expires - error message displayed • Any other error occurred and is displayed
Measurement Mode	Pulsing			<ul style="list-style-type: none"> • Measurement in progress
	Solid			<ul style="list-style-type: none"> • Measurement complete
		Blinking		<ul style="list-style-type: none"> • Measurement outside limits • Error occurred
Calibration Mode	Pulsing			<ul style="list-style-type: none"> • Calibration in progress
	Solid			<ul style="list-style-type: none"> • Calibration complete
		Blinking		<ul style="list-style-type: none"> • Calibration not successful • Error occurred
Data Transfer	Pulsing			<ul style="list-style-type: none"> • Data transfer in progress
	Solid			<ul style="list-style-type: none"> • Data transfer complete
		Blinking		<ul style="list-style-type: none"> • Data transfer not successful • Error occurred
Sleep Mode			Solid	<ul style="list-style-type: none"> • Meter in Sleep Mode • Press On/Off to re-activate meter

3.7 Acoustic signal

To use the acoustic signals, they have to be enabled in the instrument setup (see section Sounds and visuals (page 23)). You can enable or disable the acoustic signal for the following features:

- Keypress
- Alarm Messages
- Measurement endpoint

4 Putting into Operation

4.1 Scope of delivery

Check the completeness of the delivery. The following parts belong to the standard equipment of your new instrument. Further parts may be included depending on the ordered kit versions.

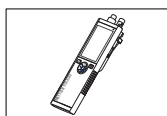

S8 instrument
for pH/Ion measurement

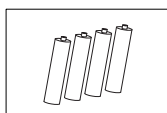

Battery LR3/AA 1.5V
4 pcs.

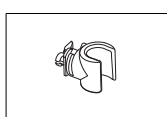

Electrode holder

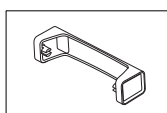

Meter base unit



CD-ROM including operating instructions

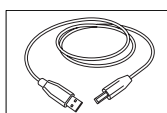

USB-A to micro-USB cable for connection to PC,
length = 1 m

See also

- Product Portfolio (page 47)

4.2 Installing the batteries

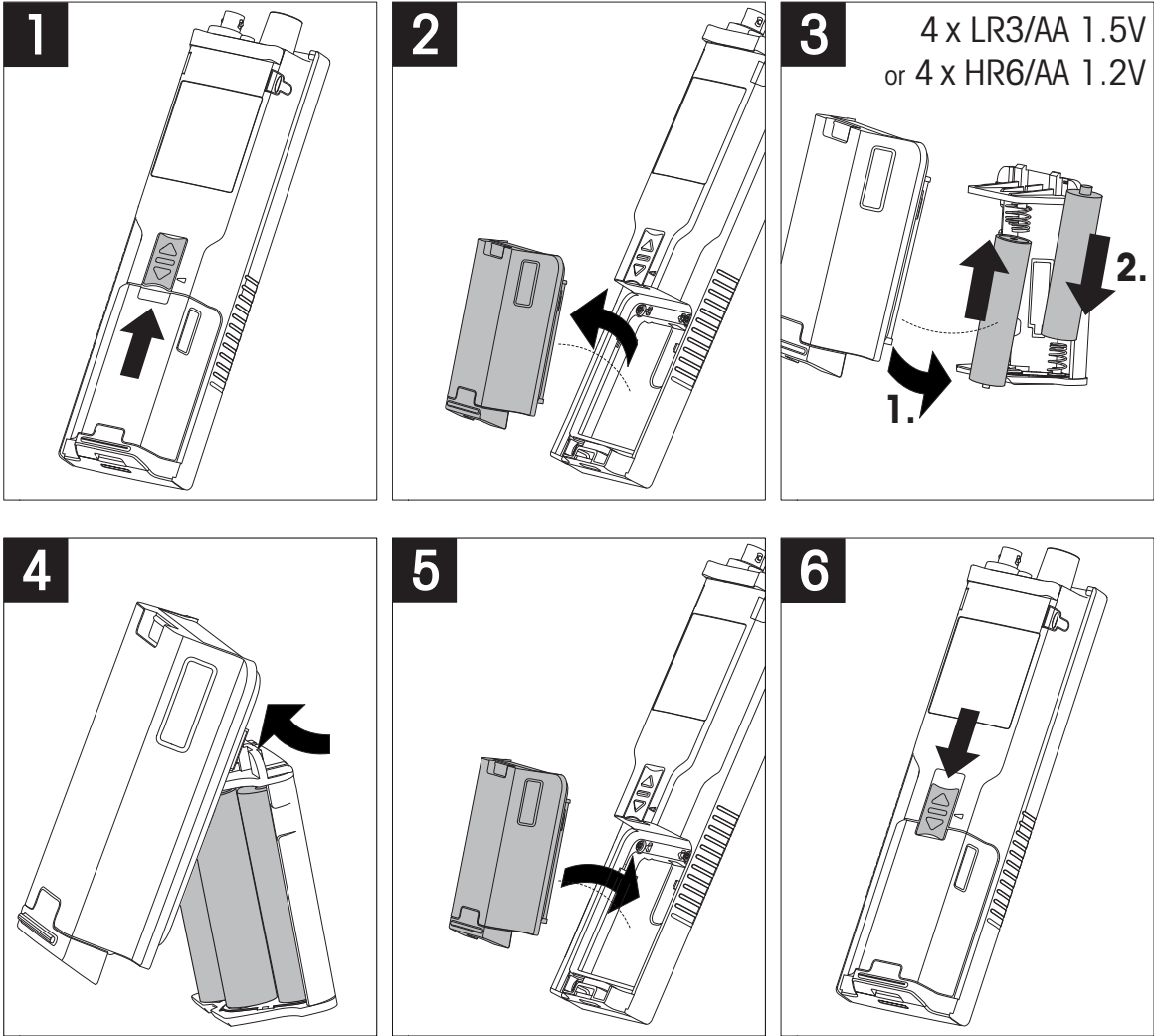

4.3 Installing power supply

The instrument is not supplied with an AC adapter.

Alternatively, the instrument can be supplied by an external power supply unit (not included in the scope of delivery) via the Micro-USB socket. Use an AC adapter that is suitable for all line voltages in the range of 100 to 240 V, 50/60 Hz and incorporates a USB socket. For connection, a suitable USB cable with an Micro-USB plug is required.

While the instrument is powered by the external power supply, the batteries are not being used. The icon  is shown on the screen.

Attention

- Take care that the AC adapter does not come into contact with liquids!
- The power plug must be accessible at all times!

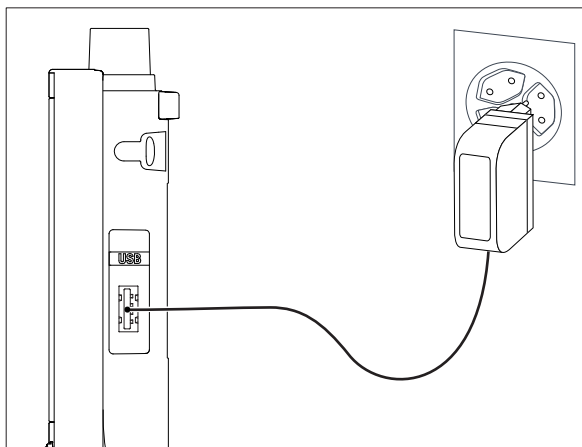

- 1 Connect the cable of the AC adapter with the Micro-USB socket of the instrument.
- 2 Plug the AC adapter into the wall socket.

4.4 Connecting sensors

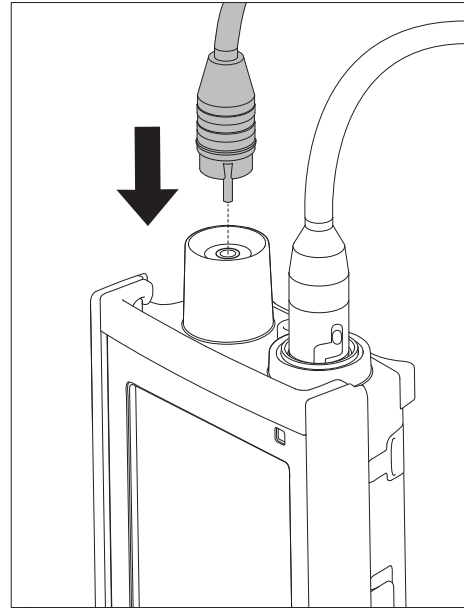
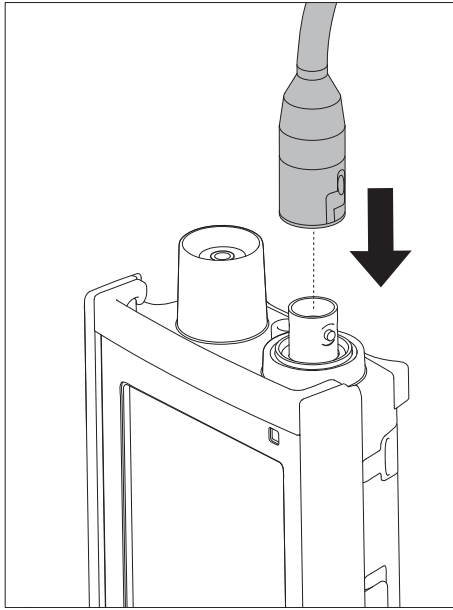

ISM® sensor

When connecting an ISM® sensor to the meter, one of the following conditions has to be met for the calibration data to be transferred automatically from the chip of the sensor into the meter and usage for further measurements. After attaching the ISM® sensor the following steps must be followed:

- Switch on the meter.
- Press **Read** key or press **Cal** key.

The icon **ISM** appears on the display. The sensor ID of the sensor chip is registered and appears on the display.

The calibration history and the sensor-data can be reviewed in the data menu.

Note

- We strongly recommend to switch off the meter when disconnecting an ISM sensor! In doing so, you make sure that the sensor is not removed while the instrument is reading data from or writing data to the ISM-chip of the sensor.

4.5 Installing optional equipment

4.5.1 Electrode holder

For a safe placing of the electrode you can mount an electrode holder on the side of the instrument. The electrode holder is part of delivery. You can mount it on either sides of the instrument for your personal handling.

- 1 Remove the protective clips (1).

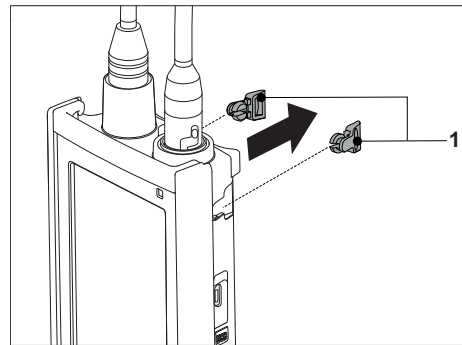

- 2 Push the electrode holder (1) into the recess (2) of the instrument.

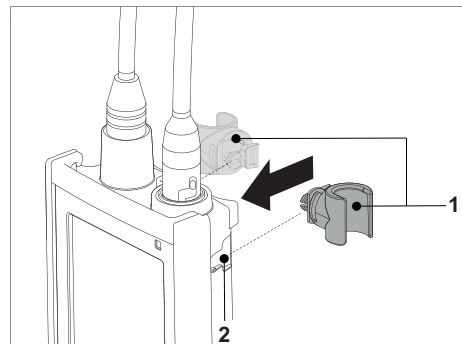

4.5.2 Meter base stabilizing unit

The meter base stabilizing unit should be mounted when using the instrument on a desk. It ensures a more firm and secure stand when pressing the keys.

- 1 Remove the protective clips (1).

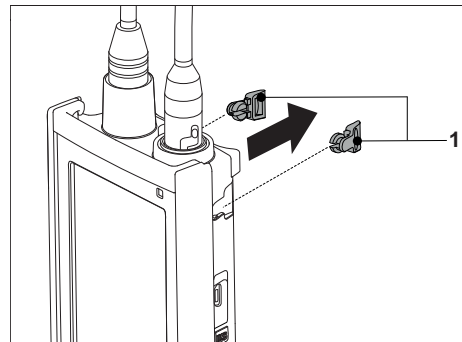

- 2 Push the meter base stabilizing unit (1) into the recesses (2) of the instrument.

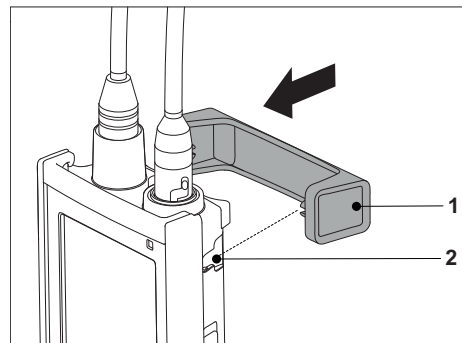

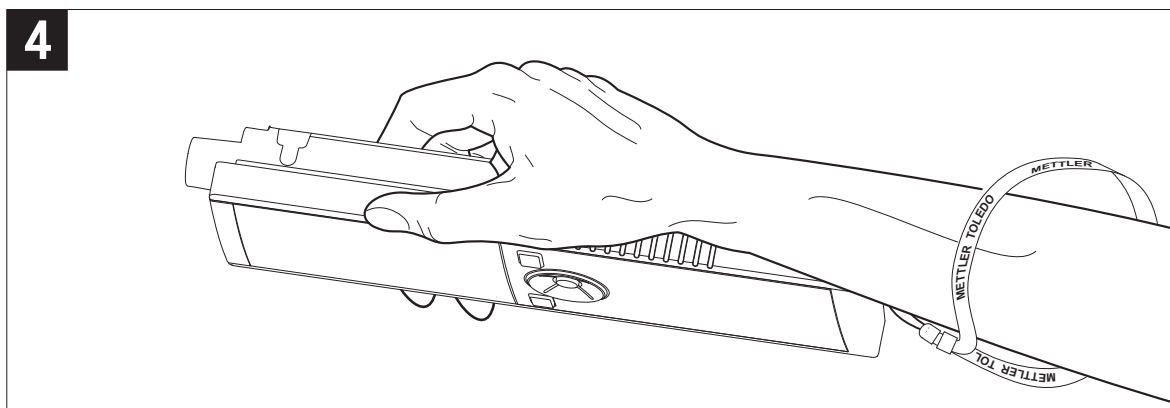
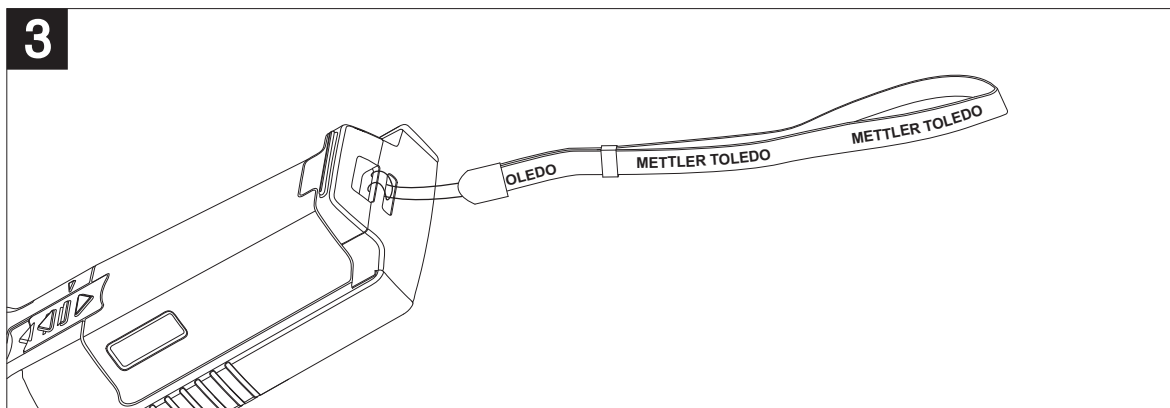
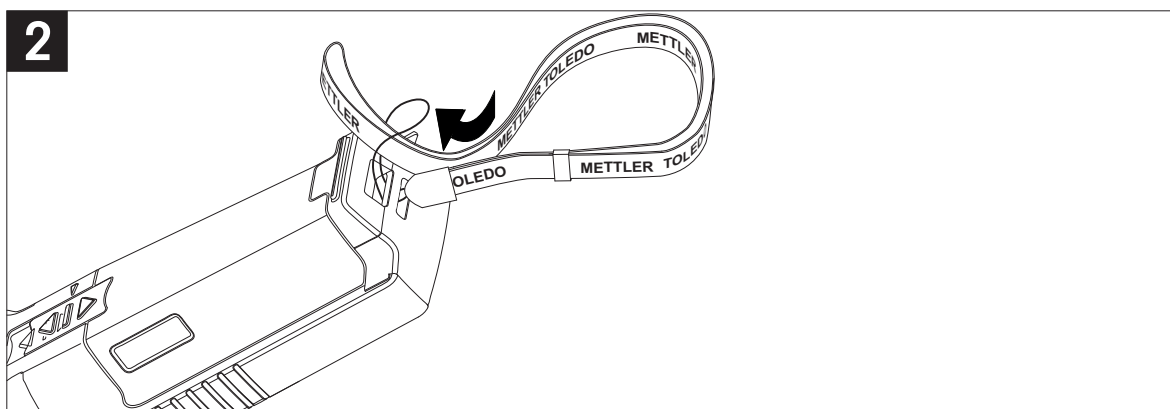
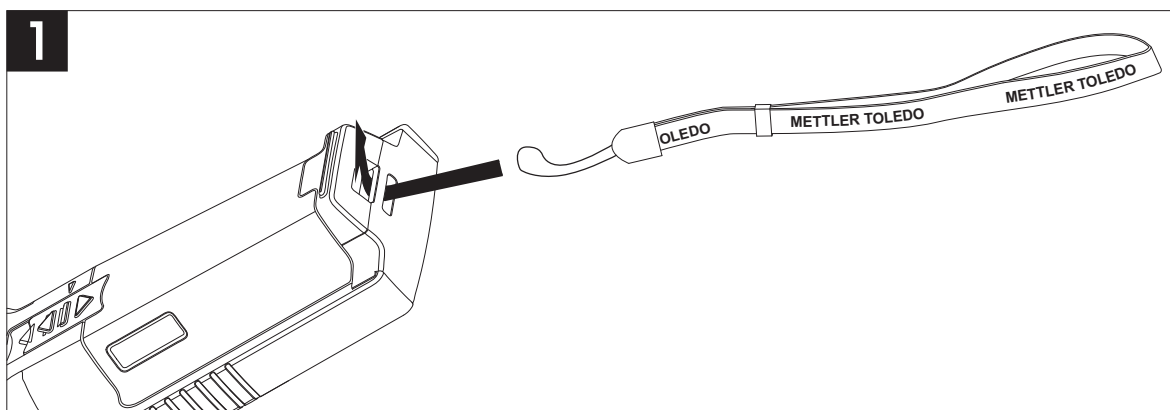

4.5.3 Wrist strap

For better protection against damage caused by dropping, you can mount the wrist strap as shown in the following diagrams.



4.6 Switching the instrument on and off

- 1 Press  to switch on the instrument.
 - ⇒ The firmware version, the serial number and the current date are displayed for about 5 seconds. After that the instrument is ready for use.
- 2 Press  for 3 seconds and release to switch off the instrument.

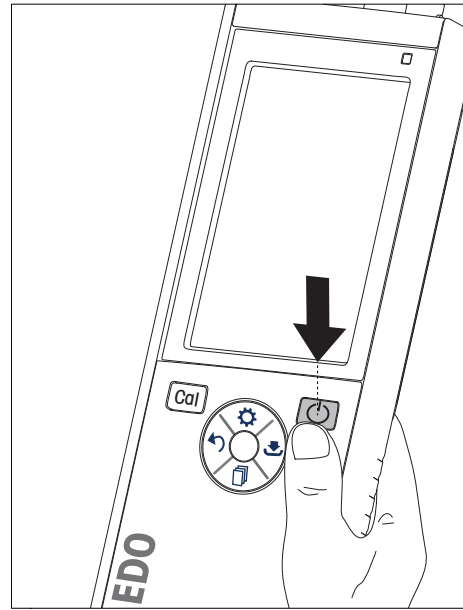



Note

- By default after 10 minutes not in use, the instrument changes to sleep mode. This can be changed in the setup.
- When starting the meter for the first time, the display for entering time and date appears automatically. These settings can be changed later again.

See also

- Power management (page 24)
- Time and date (page 22)

5 Instrument Setup

- 1 Press  to enter the menu.
- 2 Go to .

Menu structure

1.	Data Storage
1.1	Storage Mode
1.1.1	Automatic Storage
1.1.2	Manual Storage
1.2	Storage Destination
1.2.1	Memory
1.2.2	LabX Direct
1.2.3	Memory + LabX Direct
2.	System Settings
2.1	Language
2.2	Time and Date
2.3	Access Control
2.4	Sounds & Visuals
2.5	User Mode
2.6	Power Management
3.	Factory Reset
4.	Instrument Self-test

5.1 Data storage

5.1.1 Storage mode

- **Automatic storage:**
In this storage mode, all measurement results are getting saved automatically to the selected storage destination.
- **Manual storage:**
In this mode, the user has to save a measurement result manually by pressing . For this, the user gets a message on the display after every measurement.

5.1.2 Storage destination

There are different possibilities to store the measurement results. The Seven2Go pro meter provides 2000 internal memory locations (**M0001 - M2000**).

- **Memory:**
The measurement results are saved in the internal memory.
- **LabX Direct:**
The measurement results are transferred only to LabX Direct. For this a PC connection via USB is required. The PC software LabX®direct must be setup accordingly.
- **Memory + LabX Direct:**
The measurement results are saved in the internal memory and transferred to LabX®Direct. For this a PC connection via USB is required. The PC software LabX®direct must be setup accordingly.

5.2 System settings

5.2.1 Language

The following languages are available for the system:

- English
- German
- French
- Spanish
- Italian
- Portuguese
- Polish
- Russian
- Chinese
- Japanese
- Korean
- Thai

5.2.2 Time and date

When starting the meter for the first time, the display for entering time and date appears automatically. In the system settings, two time and four date display formats are available:

- **Time**
 - 24-hour format (for example, 06:56 and 18:56)
 - 12-hour format (for example, 06:56 AM and 06:56 PM)
- **Date**
 - 28-11-2013 (day-month-year)
 - 11-28-2013 (month-day-year)
 - 28-Nov-2013 (day-month-year)
 - 28/11/2013 (day-month-year)

5.2.3 Access control

PIN settings are available for:

- **System Settings**
- **Deletion of Data**
- **Instrument Login**

A maximum of 6 characters can be entered as PIN. When enabling an access control, the PIN must be defined and re-entered for verification.

Note

- Access control for system settings cannot be disabled as long as the instrument is operated in routine mode!

See also

- User modes (page 23)

5.2.4 Sounds and visuals

An acoustic signal can be switched on or off for the following three cases:

- Key is pressed
- Alarm/warning message appears
- Measurement is stable and has endpointed (stability signal appears)

The LED can be switched on or off for the following three cases:

- Alarm message
- Measurement endpoint
- System info

5.2.5 User modes

The meter has three user modes:

Routine Mode:

Limited access rights. The user can only perform measurements, calibrations, review results and change basic settings. The concept of the routine mode is a GLP feature which ensures that important settings and stored data cannot be deleted or unintentionally changed. The following operations are blocked in routine mode:

- Deletion of data
- Measurement and Calibration settings (except choosing reference temperature)
- Create sensor ID
- Factory reset
- Instrument self-test
- System settings can be accessed by entering PIN code (by default 000000)

Expert Mode:

The factory default setting enables all functions of the meter.

Outdoor Mode:

The user has full access rights (like in expert mode). The screen is always in uFocus view and the following parameters are set to specific values to reduce battery consumption:

- Auto dimming after 20 s
- Auto shutdown after 10 min
- All LED signals off

5.2.6 Power management

Screen Brightness:

The screen brightness can be set from levels 1 to 16.

Auto Dimming:

You can activate the auto dimming function for power saving. For this you can define a time period from 5 - 300 s. This is the time when the period backlight is switched off after the instrument is not in use.

Energy Saving:

You can activate either auto sleep or auto shutdown for saving energy.

Auto Sleep

The instrument changes into the sleep modus (standby) after a defined time of not in use. The instrument does not shut down automatically. You can define a time period between 5 - 99 minutes. The orange LED light indicates that the instrument currently is in sleep mode. Press  to activate the meter.

Auto Shutdown

The instrument shuts down automatically after a defined time of not in use. You can define a time period between 5 - 99 minutes.





5.3 Factory reset



Note



Loss of data!

With a factory reset all settings will be set to default values and all data memories will be deleted.

- 1 Press  to enter the setup menu.
- 2 Go to  > **Factory Reset**.
- 3 Press **Read** to confirm the factory reset or press  to cancel.
 - ⇒ When confirmed, all settings have default values and the memory is fully cleared.
- 4 Press and hold  to exit the setup menu.

5.4 Instrument self-test

The instrument self-test allows to check if display, LED, beep and keys are working correctly.

- 1 Press  to enter the setup menu.
 - 2 Go to  > **Instrument Self-test**.
 - 3 Press **Read** to start the self-test.
 - ⇒ **Display:** All pixels of the display are shown black for 2 seconds, then white for 2 seconds.
 - ⇒ **LED:** The LED changes color to green, orange and flashing red.
 - ⇒ **Beep and keys:** The icons for the seven keys are shown on the screen, each keypress lets its icon disappear while a beep sounds. The keys must be pressed within 20 seconds.
- ⇒ If the self-test is successful, **OK** appears on the screen and the LED is green for 2 seconds. Otherwise **Self-test failure** appears and the LED flashes red. In both cases the instrument then goes back to normal mode.

6 pH/Ion Settings

1 Press  to enter the menu.

2 Go to **pH/Ion**.

1.	Calibration Settings
1.1	Buffer Group / Standard
1.1.1	Predefined Buffer Groups
1.1.2	Customized Buffer Groups
1.1.3	Ion-standards
1.2	Calibration Mode
1.2.1	Segmented
1.2.2	Linear
1.3	Calibration Reminder
2.	Measurement Settings
2.1	Resolution
2.2	Stability Criterion
2.3	Ion Measurement Unit
2.4	Ion Type
2.5	Rel. mV Offset
2.5.1	Enter Offset Value
2.5.2	Test a Reference Sample
3.	Endpoint Type
4.	Interval Readings
5.	Temperature Settings
5.1	Set MTC Temperature
5.2	Temperature Unit
6.	Measurement Limits
6.1	pH Limit
6.2	mV Limit
6.3	Rel. mV Limit
6.4	Ion Limit
6.5	Temperature Limit

6.1 Calibration settings

6.1.1 Buffer Group/Standard

6.1.1.1 Predefined groups

The following pre-defined buffer groups are available:

- MT USA (Ref. 25 °C)
- MT Europe (Ref. 25 °C)
- MERCK (Ref. 20 °C)
- DIN(19266)/NIST (Ref. 25 °C)
- DIN(10267) (Ref. 25 °C)
- JIG119 (Ref. 25 °C)
- Technical (Ref. 25 °C)
- JIS Z 8802 (Ref. 25 °C)

1 Press  to enter the setup menu.

2 Go to **pH/Ion** > **Calibration Settings** > **Buffer Group / Std.** > **Predefined Groups**.

3 Select a standard using  and .

4 Press **Read** to confirm.

⇒ A table with the specific buffers is shown on the screen.

5 Press **Read** to confirm.





6 Press  twice.

7 Press and hold  to exit the setup menu.

6.1.1.2 Customized group

This option is for users who would like to use their own buffer solutions for calibration of the pH sensor. Up to 5 temperature-dependent values can be entered in the table. You can enter buffers in the range of pH -2.000 to pH 20.000.

When switching from a predefined buffer to customized buffer, you should always save the table even if no values have changed.

- 1 Press  to enter the setup menu.
- 2 Go to **pH/Ion > Calibration Settings > Buffer Group / Std. > Customized Group**.
⇒ All values in the table can be modified. To do so follow these steps:
- 3 Select a temperature value by using  and  and press **Read**.
- 4 Change the selected temperature step by step using the TPad keys and press **Read** to confirm.
- 5 Navigate down to the next temperature and modify it in the same manner.
- 6 Repeat this for all five temperature values. To delete any value, press and hold **Read**.
- 7 Navigate to the column of the first buffer solution using the TPad keys.
- 8 Enter or modify the correct pH value for each temperature value in the above described way.
- 9 Navigate further right to proceed with second, third, fourth and fifth buffer solution. Clear all cells of the last columns if you use less than five buffers.
- 10 Navigate to Save and press **Read** to save your changes.
- 11 Press  twice.
- 12 Press and hold  to exit the setup menu.





Note

- The table must not have empty cells except at the bottom and at the right.
- The temperatures must be strictly increasing from top to bottom of the table.
- There must be a difference of at least 5 °C between two temperatures and at least 1 pH unit between two buffer solutions. Otherwise the error message **Wrong settings** pops-up when saving.
- Calibration is only possible within the defined temperature range (± 0.5 °C). For example, calibration at 26 °C fails if only pH values at 20 °C and 25 °C are defined.

6.1.1.3 Ion-standard

Concentrations for up to 5 ion-standards with one standard temperature can be defined. The ion-concentration unit for measurements and calibration can be defined. Six concentration units are available:

- mmol/L
- mol/L
- ppm
- mg/L
- %
- pX



- 1 Press  to enter the setup menu.
- 2 Go to **pH/Ion > Calibration Settings > Buffer Group / Std. > Ion-standards**.
- 3 Choose the concentration unit you want to define.
- 4 Press **Read** to change the calibration temperature (standard = 25 °C).
- 5 Change the temperature digit by digit using the TPad keys and press **Read** to confirm.
- 6 Press  to switch to Standard 1 and press **Read** to edit the Standard value.
- 7 Change the Standard value digit by digit using the TPad keys and press **Read** to confirm.
- 8 Repeat the previous step on Standard 2 - Standard 5. To delete any value, press and hold **Read**.
- 9 Go to **Save** and press **Read** to save your changes.
- 10 Press  twice.
- 11 Press and hold  to exit the setup menu.

Note

- The table must not have empty cells except at the bottom.
- Calibration must happen exactly in the order the standards are entered. It is strongly recommended to start with the lowest concentration.
- Calibration is only possible in at the defined temperature (± 0.5 °C).





6.1.2 Calibration mode

There are two calibration modes available:

- **Segmented:**
The calibration curve is made up of linear segments joining the individual calibration points. If high accuracy is required, the segment method is recommended.
 - **Linear:**
The calibration curve is determined using linear regression. This method is recommended for samples with widely varying values.
- 1 Press  to enter the setup menu.
 - 2 Go to **pH/Ion > Calibration Settings > Calibration Mode**.
 - 3 Select the calibration mode (**Segmented/Linear**).
 - 4 Press **Read** to confirm.
 - 5 Press .
 - 6 Press and hold  to exit the setup menu.

6.1.3 Calibration reminder

When the calibration reminder is activated, the user is reminded to perform a new calibration after a certain user-defined interval (maximum 9999 h) has elapsed.





- 1 Press  to enter the setup menu.
- 2 Go to **pH/Ion > Calibration Settings > Calibration Reminder**.
- 3 Choose **On** or **Off** by using  and .
- 4 Press **Read** to confirm.
 - ⇒ Another screen appears to enter the interval time.
- 5 Enter the interval time by using the TPad keys and press **Read** to save.
 - ⇒ Another screen appears to select calibration expiration date. Select as of when the sensor should be blocked for further measurements as soon as the entered interval has elapsed.
 - ⇒ **Immediately:**
The meter is immediately blocked for measurement when the predefined interval has elapsed.
 - ⇒ **Exp: Reminder + 1 h:**
The meter is blocked for measurement 1 hour after the predefined interval has elapsed.
 - ⇒ **Exp: Reminder + 2 h:**
The meter is blocked for measurement 2 hours after the predefined interval has elapsed.
 - ⇒ **Continue Reading:**
The user can continue measuring when the predefined interval has elapsed.
- 6 Press **Read** to confirm.
- 7 Press .
- 8 Press and hold  to exit the setup menu.

6.2 Measurement settings

6.2.1 Resolution

The resolution of up to 3 decimal places for pH and mV can be chosen in the setup.





	X	X.X	X.XX	X.XXX
pH		•	•	•
mV	•	•		

- 1 Press  to enter the setup menu.
- 2 Go to **pH/Ion > Measurement Settings > Resolution**.
- 3 Choose **pH** or **mV**.
- 4 Choose the resolution by using  and  and press **Read** to confirm.
- 5 Press  twice.
- 6 Press and hold  to exit the setup menu.

6.2.2 Stability criterion

You can set 3 different stability criterias on your device:

- **Fast** :
Value varies less than 0.6 mV during 4 seconds which corresponds to 0.1 pH.
- **Medium** :
Value varies less than 0.1 mV during 6 seconds which corresponds to 0.05 pH.
- **Strict** :
Value varies less than 0.03 mV during 8 seconds or less than 0.1 mV during 20 seconds.

- 1 Press  to enter the setup menu.
 - 2 Go to **pH/Ion > Measurement Settings > Stability Criterion**.
 - 3 Choose the stability criterion by using  and  and press **Read** to confirm..
 - 4 Press .
 - 5 Press and hold  to exit the setup menu.
- ⇒ The specific icon is shown on the screen.

6.2.3 Ion measurement unit

The ion concentration unit for measurements and calibration can be selected between the following six units:

- mmol/L
- mol/L
- ppm
- mg/L
- %
- pX

Note



- Because the molar mass of the ion of interest is known, the meter can even be used to measure in mmol/L, mol/L or pX when calibrated with ppm, mg/L or % - or vice-versa.

6.2.4 Ion type

When using an ion sensor to which a sensor ID has been assigned, the ion type that has been assigned to this sensor ID is automatically used. However, in case one would like to measure without a sensor ID, it is important to assign the correct ion type. This is because the theoretical slope depends on the charge of the ion and the conversion of measurement units depends on the molar mass.

Eight specific and four general ion types are available:



- F- (fluoride)
- Cl- (chloride)
- CN- (cyanide)
- NO₃- (nitrate)
- Na+ (sodium)
- K+ (potassium)
- Ca²⁺ (Calcium)
- Cu²⁺ (cuprous)
- Ion-
- Ion+
- Ion²⁻
- Ion²⁺

- 1 Press  to enter the setup menu.
- 2 Go to **pH/Ion > Measurement Settings > Ion Type**.
- 3 Choose the ion type and press **Read** to confirm.
- 4 If a non-specific ion is selected, its molar mass (0.001 to 1000 g/mol) must be entered digit by digit using the TPad keys. Press **Read** to save the value.
- 5 Press .
- 6 Press and hold  to exit the setup menu.



6.2.5 Rel. mV offset

In the **Rel. mV Offset** mode, the offset value is subtracted from the measured value. Either an offset value can be entered (-1999 ... +1999) or it can be determined by measuring the mV reduction potential of a reference sample.

Entering the Rel. mV Offset:

- 1 Press  to enter the setup menu.
- 2 Go to **pH/Ion > Measurement Settings > Rel. mV Offset**.
- 3 Select **Enter Offset Value** for entering an offset value.
- 4 Enter an offset value digit by digit by using the TPad keys.
- 5 Press **Read** to confirm.
- 6 Press  twice.
- 7 Press and hold  to exit the setup menu.



Determining the Rel. mV Offset:

- 1 Press  to enter the setup menu.
- 2 Go to **pH/Ion > Measurement Settings > Rel. mV Offset**.
- 3 Select **Test a Ref. Sample** if you want to measure a reference sample.
- 4 Place the sensor into the sample and press **Read** to start the measurement.
 - ⇒ The decimal point and - depending on the endpoint format setting - **A** (automatic), **T** (timed) or **M** (manual) are blinking during the measurement.
- 5 When the measurement has endpointed, the display freezes.
 - ⇒ The measurement result is displayed.
- 6 Press **Read** to save the measurement data.
- 7 Press  twice.
- 8 Press and hold  to exit the setup menu.

6.3 Endpoint type



Auto Endpoint

With the automatic endpoint the meter defines the end of an individual reading depending on programmed stability criterion for the signal. This ensures an easy, quick and precise measurement.

- 1 Press  to enter the setup menu.
- 2 Go to **pH/Ion > Endpoint Type**.
- 3 Select **Auto EP** and press **Read** to confirm.
- 4 Press .
- 5 Press and hold  to exit the setup menu.



Manual Endpoint

In this mode, the user is required to stop the measurement reading manually.

- 1 Press  to enter the setup menu.
- 2 Go to **pH/Ion > Endpoint Type**.
- 3 Select **Manual EP** and press **Read** to confirm.
- 4 Press .
- 5 Press and hold  to exit the setup menu.

Timed Endpoint

The measurement stops after the defined time, which can be set between 5 s and 3600 s.



- 1 Press  to enter the setup menu.
- 2 Go to **pH/Ion > Endpoint Type**.
- 3 Select **Timed EP** and press **Read** to confirm.
- 4 Press .
- 5 Press and hold  to exit the setup menu.

6.4 Interval readings

A reading is taken every time after a certain interval (1 – 2400 s) defined in the menu has elapsed. The measurement series stops according to the selected endpoint format or manually by pressing **Read**. When timed-interval reading is **On**, ^{Int.} appears on the screen.

Example:

To measure the pH value every 30 s during 5 min, set the interval time to 30 s and the endpoint type to timed with a measurement time of 5 min.



- 1 Press  to enter the setup menu.
- 2 Go to **pH/Ion > Interval Readings**.
- 3 Select **On** and press **Read** to confirm.
- 4 If interval readings has been enabled, enter the interval time digit by digit using the TPad keys.
- 5 Press **Read** save.
- 6 Press and hold  to exit the setup menu.

6.5 Temperature settings

If a temperature probe is recognized by the meter, **ATC** and the sample temperature are displayed. In case an electrode without temperature sensor is used, **MTC** is displayed and the sample temperature should be entered manually.

For pH and ion measurement, the meter uses this temperature to correct the readings according to the Nernst equation.

To set a MTC temperature follow these steps:



- 1 Press  to enter the setup menu.
- 2 Go to **pH/Ion > Temperature Settings > Set MTC Temperature**.
- 3 Enter the MTC temperature by using the TPad keys and press **Read** to save.
- 4 Press .
- 5 Press and hold  to exit the setup menu.

Note

- In **ATC** mode, the entered **MTC** temperature has no effect on the measurement.

Setting the temperature unit:

You can set the temperature unit to °C or °F.













- 1 Press  to enter the setup menu.
- 2 Go to **pH/Ion > Temperature Settings > Temperature Unit**.
- 3 Select the temperature unit and press **Read** to save.
- 4 Press .
- 5 Press and hold  to exit the setup menu.

6.6 Measurement limits

You can define limits (max. and min.) for every kind of measurement:

- **pH Limit**
- **mV Limit**
- **Rel. mV Limit**
- **Ion Limit**
- **Temperature Limit**

To set a measurement limit follow these steps:

- 1 Press  to enter the setup menu.
- 2 Go to **pH/Ion > Measurement Limits**.
- 3 Choose the desired measurement by using  and  and press **Read** to confirm.
- 4 Select **Yes** to activate the limit and press **Read** to confirm.
- 5 Press **Read** to activate or deactivate the max. Limit.
- 6 Press  and then press **Read** to select the max. limit value.
- 7 Change the max. limit value by using  and  and press **Read** to save.
- 8 Press  to switch to the min. limit.
- 9 Press **Read** to activate or deactivate the min. Limit.
- 10 Press  and then press **Read** to select the min. limit value.
- 11 Change the min. limit value by using  and  and press **Read** to save.
- 12 Go to **Save** and press **Read** to save your settings.
- 13 Press .
- 14 Press and hold  to exit the setup menu.

7 IDs

- 1 Press  to enter the menu.
- 2 Go to **ID**.

Menu structure

1.	Sample ID
1.1	Enter Sample ID
1.2	Auto Sequential
1.3	Select Sample ID
1.4	Delete Sample ID
2.	User ID
2.1	Enter User ID
2.2	Select User ID
2.3	Delete User ID
3.	Sensor ID / SN
3.1	Enter Sensor ID / SN
3.2	Select Sensor ID

7.1 Sample ID

- 1 Press  to enter the setup menu.
- 2 Go to **ID Settings > Sample ID**.

Go to **Enter Sample ID** to enter a new sample ID. An alphanumeric sample ID with up to 12 characters can be entered.

Auto sequential:

1. **Auto Sequential = On**
Using this setting will automatically increment the sample ID by 1 for each reading. If the last character of the sample ID is not a number, then the number 1 will be added to the sample ID with the second sample. This requires the sample ID to have less than 12 characters.
2. **Auto Sequential = Off**
The sample ID is not incremented automatically.

To select a sample ID out of a list of already entered sample IDs, go to **Select Sample ID**. A maximum of 10 sample IDs are stored in memory and listed for selection. If the maximum of 10 has already been entered, either any sample ID is deleted manually or the oldest ID will automatically be overwritten by the new ID.

To delete an existing sample ID out of the list, go to **Delete Sample ID**. Choose the sample ID you want to delete and press **Read**.

7.2 User ID

- 1 Press  to enter the setup menu.
- 2 Go to **ID Settings > User ID**.

Select **Enter User ID** to enter a new user ID. An alphanumeric user ID with up to 12 characters can be entered.

To select a user ID out of the list, go to **Select User ID**. A maximum of 10 user IDs are stored in memory and listed for selection. If the maximum of 10 has already been entered, either a user ID is deleted manually or the oldest ID will automatically be overwritten by the new ID.

To delete an existing user ID out of the list, go to **Delete User ID**. Choose the user ID you want to delete and press **Read**.

7.3 Sensor ID

- 1 Press  to enter the setup menu.
- 2 Go to **ID Settings > Sensor ID / SN**.

Select **Enter Sensor ID / SN** to enter a new sensor ID and serial number (SN). An alphanumeric sensor ID and SN with up to 12 characters can be entered.

To select a sensor ID out of the list, go to **Select Sensor ID**. A maximum of 10 sensor IDs are stored in the memory and listed for selection. If the maximum of 10 has already been entered, the oldest ID will automatically be overwritten by the new ID.



Note

- To delete a sensor from the list, delete its calibration data, see section Calibration data (page 42).

8 Sensor Calibration

The following procedure explain how to calibrate a pH electrode or an ion-selective electrode. Redox electrodes cannot be calibrated.

8.1 Performing a 1-point calibration

- ▶ A sensor is connected to the instrument.
 - ▶ The correct calibration standard and calibration mode (linear or segmented) is defined in the settings (see section Calibration settings (page 26)).
- 1 Place the sensor in a calibration standard and press **Cal** to enter the calibration menu.
 - ⇒  appears on the display.
 - 2 Press **Read** to start the calibration.
 - ⇒ Depending on the set endpoint format, the letter **A** (auto), **T** (timed) or **M** (manual) is blinking during the calibration.
 - ⇒ When the endpoint is reached, the display freezes automatically. Independent on the set endpoint format, **Read** can be pressed to endpoint the calibration manually.
 - ⇒ The calibration result is displayed.
 - 3 Press **Read** to save the calibration data or press  to cancel.

Note

- With the 1-point calibration only the offset is adjusted. If the sensor was previously calibrated with multi-point calibration the previously stored slope will remain. Otherwise the theoretical slope (-59.16 mV/pH) will be used.

8.2 Performing a 2-point calibration

- ▶ A sensor is connected to the instrument.
 - ▶ The correct calibration standard and calibration mode (linear or segmented) is defined in the settings (see section Calibration settings (page 26)).
- 1 Perform the first point calibration as described in the section Performing a 1-point calibration (page 37).
 - 2 Rinse the sensor with deionized water.
 - 3 Place the sensor in the second calibration standard and press **Cal** to start the calibration.
 - ⇒ Depending on the set endpoint format, the letter **A** (auto), **T** (timed) or **M** (manual) is blinking during the calibration.
 - ⇒ When the endpoint is reached, the display freezes automatically. Independent on the set endpoint format, **Read** can be pressed to endpoint the calibration manually.
 - 4 Press **Read** to save the calibration data or press  to cancel.

8.3 Performing a 3-, 4- or 5-point calibration

- ▶ A sensor is connected to the instrument.
 - ▶ The correct calibration standard and calibration mode (linear or segmented) is defined in the settings (see section Calibration settings (page 26)).
- 1 Perform the same steps as described in the section Performing a 2-point calibration (page 37).
 - 2 Repeat steps 2 and 3 of the section Performing a 2-point calibration (page 37) for the third, then the fourth, and finally the fifth standard.

9 Sample Measurement



9.1 Selecting a measurement unit

With the S8 pH/Ion meter it is possible to measure the following parameters of a sample:

- pH
- mV
- rel. mV
- Ion

To change the measurement mode, press  as often as the desired appears.

9.2 Performing a pH measurement

- ▶ A pH electrode is connected to the instrument.
 - ▶ The electrode is calibrated.
 - ▶ The following measurement settings are done:
 - Resolution
 - Stability criterion
 - Endpoint type
 - MTC temperature (if no temperature probe is used)
 - Data storage mode and location
- 1 Press  once or several times to switch between the measurement modes until the unit (pH) is displayed.
 - 2 Place the electrode into the sample and press **Read** to start the measurement.
 - ⇒ The decimal point and - depending on the endpoint format setting - **A** (automatic), **T** (timed) or **M** (manual) are blinking during the measurement.
 - 3 When the measurement has endpointed, the display freezes. Independent on the set endpoint format, **Read** can be pressed to endpoint the measurement manually.
 - ⇒ The measurement result is displayed.
 - ⇒ If Data Storage Mode is set to **Automatic Storage**, the complete measurement data is automatically transferred to the set storage destination.
 - 4 If Data Storage Mode is set to **Manual Storage**, press  to transfer the data to the set storage location.

Information on the display:

The following symbols appear on the display, depending on the endpoint setting.

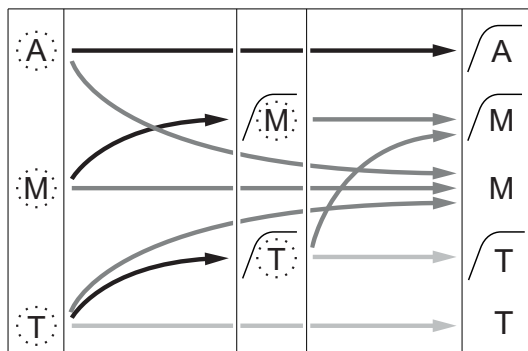

Measurement stopped automatically, reading was stable

Measurement stopped manually, reading was stable



Measurement stopped manually, reading was not stable

Measurement stopped after time, reading was stable

Measurement stopped after time, reading was not stable

- Defined measurement time elapsed
- User presses **Read**
- Signal becomes stable

9.3 Performing a mV or rel. mV measurement



- ▶ A redox electrode is connected to the instrument.
 - ▶ The electrode is calibrated.
 - ▶ The following measurement settings are done:
 - Resolution
 - Stability criterion
 - Rel. mV offset (if measuring rel. mV)
 - Endpoint type
 - MTC temperature
 - Data storage mode and location
- 1 Press  once or several times to switch between the measurement modes until the relevant unit (mV or rel. mV) is displayed.
 - 2 Place the sensor into the sample and press **Read** to start the measurement.
 - ⇒ The decimal point and - depending on the endpoint format setting - **A** (automatic), **T** (timed) or **M** (manual) are blinking during the measurement.
 - 3 When the measurement has endpointed, the display freezes. Independent on the set endpoint format, **Read** can be pressed to endpoint the measurement manually.
 - ⇒ The measurement result is displayed.
 - ⇒ If Data Storage Mode is set to **Automatic Storage**, the complete measurement data is automatically transferred to the set storage destination.
 - 4 If Data Storage Mode is set to **Manual Storage**, press  to transfer the data to the set storage location.

Information on the display:

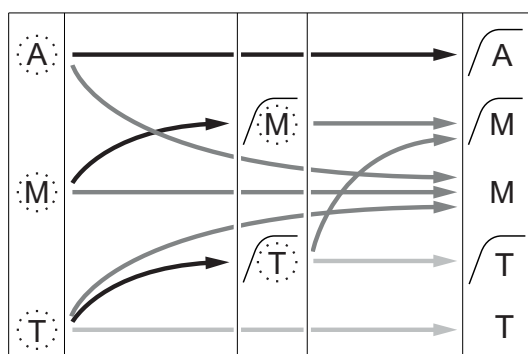
The following symbols appear on the display, depending on the endpoint setting.





- Measurement stopped automatically, reading was stable
- Measurement stopped manually, reading was stable
- Measurement stopped manually, reading was not stable
- Measurement stopped after time, reading was stable
- Measurement stopped after time, reading was not stable

-  Defined measurement time elapsed
-  User presses **Read**
-  Signal becomes stable

See also

- Performing a pH measurement (page 38)

9.4 Performing an ion measurement

- ▶ An ion-selective electrode is connected to the instrument.
 - ▶ The electrode is calibrated.
 - ▶ The following measurement settings are done:
 - Stability criterion
 - Ion measurement unit
 - Ion type
 - Endpoint type
 - MTC temperature
 - Data storage mode and location
- 1 Prepare the sample according to the ion-selective electrode's manual (i.e. add correct ISA solution).
 - 2 Press  once or several times to switch between the measurement modes until the relevant unit (mmol/L, mol/L, ppm, mg/L, %, pX) and chosen ion is displayed.
 - 3 Place the sensor into the sample and press **Read** to start the measurement. It is strongly recommended to stir the sample during measurement.
 - ⇒ The decimal point and - depending on the endpoint format setting - **A** (automatic), **T** (timed) or **M** (manual) are blinking during the measurement.
 - 4 When the measurement has endpointed, the display freezes. Independent on the set endpoint format, **Read** can be pressed to endpoint the measurement manually.
 - ⇒ The measurement result is displayed.
 - ⇒ If Data Storage Mode is set to **Automatic Storage**, the complete measurement data is automatically transferred to the set storage destination.
 - 5 If Data Storage Mode is set to **Manual Storage**, press  to transfer the data to the set storage location.

Information on the display:

The following symbols appear on the display, depending on the endpoint setting.

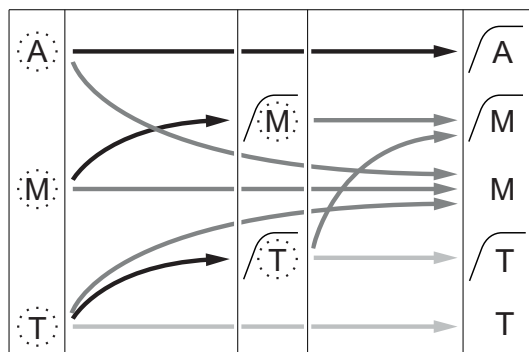

Measurement stopped automatically, reading was stable

Measurement stopped manually, reading was stable

Measurement stopped manually, reading was not stable

Measurement stopped after time, reading was stable

Measurement stopped after time, reading was not stable

 Defined measurement time elapsed

 User presses **Read**

 Signal becomes stable

10 Data Management

10.1 Data menu structure

Press **↵** to enter and also to exit the setup menu.

1.	Measurement Data
1.1	Review
1.2	Transfer
1.3	Delete
2.	Calibration Data
2.1	pH
2.1.1	Review
2.1.2	Transfer
2.1.3	Delete
2.2	Ion
2.2.1	Review
2.2.2	Transfer
2.2.3	Delete
3.	ISM Data
3.1	Initial Calibration Data
3.2	Calibration History
3.3	Electrode Records
3.4	Reset ISM

10.2 Measurement data

Review > All

Transfer > All

Delete > All:

All stored measurement data can be reviewed, transferred or deleted. The most recent data saved appears on the display.

Review > Partial

Transfer > Partial

Delete > Partial:

Partially selected measurement data can be reviewed, transferred or deleted. The measurement data can be filtered according to 4 criteria.

- Date/Time
- Sample ID
- Measurement mode
- Memory number

Note

- When filtering by date/time, the date must always be entered. If the time 00:00 is used, all results from the whole day are showed/transferred/deleted. Otherwise only the results exactly at the given date and time are affected.

Delete > All After Transfer:

All stored measurement data can be transferred to a PC with software LabX@direct. The measurement data will be deleted automatically after transfer.

10.3 Calibration data

Review:

The stored calibration data of the selected sensor can be reviewed.

Transfer:

All stored calibration data of the selected sensor can be transferred to a PC with software LabX@direct.

Delete:

The calibration data of the selected sensor is deleted. As the same time the sensor ID is deleted from the sensor ID list.

Note

- It is not possible to delete the active sensor. Choose a different one from the sensor ID list first.

10.4 ISM data

Seven2Go meters incorporate Intelligent Sensor Management (ISM[®]) technology. This ingenious functionality provides extra security, safety and eliminates mistakes. The most important features are:

Extra security!

- After connecting the ISM[®] sensor, the sensor is automatically recognized and the sensor ID and serial number are transferred from the sensor chip to the meter. The data is also printed on the GLP printout.
- After calibration of the ISM[®] sensor, the calibration data is automatically stored from the meter to the sensor chip. The most recent data is always stored where it should be – on the sensor chip!

Extra safety!

After connecting the ISM[®] sensor, the five most recent calibrations are transferred to the meter. These can be reviewed to see the development of the sensor over time. This information provides an indication if the sensor should be cleaned or renewed.

Eliminate mistakes!

After connecting an ISM[®] sensor, the last set of calibration data is automatically used for measurements.

Additional features are described below.

In the ISM data menu you have the following submenus:

Initial calibration data

When an ISM[®] sensor is connected, the initial calibration data in the sensor can be reviewed or transferred. The following data is included:

- Initial name of electrode (for example, InLab[®] Expert Pro ISM)
- Serial number (SN) and ordering number
- Slope between pH 4 and 7
- Zero point (offset value)
- Membrane resistance
- Response time to achieve 98% signal change between pH 4 and 7
- Temperature tolerance

Calibration history

The last 5 calibrations data stored in ISM[®] sensor including current calibration can be reviewed or transferred.

Electrode Records

Beside the initial electrode name and serial number, the maximum temperature the sensor measured and the date when this happened can be reviewed.

Reset ISM[®]





The calibration history in this menu can be deleted. This menu is protected by a deletion PIN. Upon delivery, the PIN for deletion is set to 000000. Change the PIN to prevent unauthorized access.

10.5 Data export to PC

It is possible to transfer either all data or a user-defined set of data from the memory to a PC by using LabX@direct. The settings between the instrument and PC are adjusted automatically because USB connection is plug-and-play.

The following section describes how to proceed with the different configurations.

Data transfer from the meter to LabX@direct

- 1 Connect the instrument via USB-B to the PC.
⇒  appears on the display.
- 2 Press  to enter the setup menu.
- 3 Go to  > **Data Storage** > **Storage Destination** and select **LabX Direct**.
- 4 Press  for 3 s to leave the setup menu.
- 5 Open the software **LabX@direct pH** and select the correct instrument.
- 6 Press  to enter the data menu.
- 7 Go to **Measurement Data** > **Transfer** and select the data you want to transfer.
⇒ The transfer starts automatically after the data content is selected.

11 Maintenance

11.1 Electrode maintenance

- Make sure pH electrodes are always kept filled with the appropriate filling solution.
- For maximum accuracy, any filling solution that may have crystallized and encrusted the outside of the electrode should be removed with deionized water.
- Always store the electrode according to the manufacturer's instructions and do not allow it to dry out.

If the electrode slope falls rapidly, or if the response becomes sluggish, the following procedures may help. Try one of the following, depending on your sample. Run a new calibration after treatment.

Symptom	Procedure
Fat or oil build-up.	Degrease the membrane with cotton wool soaked in either acetone or a soap solution.
Membrane has dried out.	Soak the tip of the electrode overnight in 0.1M HCl.
Protein build-up in the diaphragm.	Remove deposits by soaking the electrode in an HCl/pepsin solution.
Silver sulfide contamination.	Remove deposits by soaking electrode in a thiourea solution.

Note

- Cleaning and filling solutions should be handled with the same care as that given to toxic or corrosive substances.

11.2 Software update

A software update can only be done by an authorized METTLER TOLEDO Service agent!

11.3 Repair of the instrument

Seven2Go meters can be repaired. Please ask the METTLER TOLEDO Service department for more information.

11.4 Disposal

In conformance with the European Directive 2002/96/EC on Waste Electrical and Electronic Equipment (WEEE) this device may not be disposed of in domestic waste. This also applies to countries outside the EU, per their specific requirements.

Please dispose of this product in accordance with local regulations at the collecting point specified for electrical and electronic equipment. If you have any questions, please contact the responsible authority or the distributor from which you purchased this device. Should this device be passed on to other parties (for private or professional use), the content of this regulation must also be related.

Thank you for your contribution to environmental protection.



12 Technical Data

General

Power rating (batteries)	Batteries	4 x LR6/AA 1.5 V Alkaline - or - 4 x HR6/AA 1.3 V NiMH rechargeable
	Battery life (Standby)	200... 250 hrs
Power rating (USB powered)	Connection	Micro-USB
	Rating	5 V $\overline{\text{DC}}$, 200 mA
Dimensions	Height	222 mm
	Width	70 mm
	Depth	35 mm
	Weight	290 g
Display	LCD	Graphic LCD display
Interfaces	PC connection	Micro-USB
Ambient conditions	Ambient temperature	0...40 °C
	Relative humidity	5%...85% (non-condensing) at 31 °C, linearly descending to 50% at 40 °C
	Overvoltage category	Class II
	Pollution degree	2
	Maximum operating altitude	Up to 2000 m
	Range of application	For indoor and outdoor use
Materials	Housing	ABS/PC reinforced
	Window	Polymethyl methacrylate (PMMA)
Data security / storage	ISM®	Yes
	Memory size	2000 (GLP conform)

Measurement

Parameters	pH, mV, rel. mV	
Sensor inputs	pH/mV	BNC
	Reference electrode	2 mm banana
	Temperature	RCA cinch
pH	Measuring range	-2...20
	Resolution	0.001 / 0.01 / 0.1
	Accuracy (sensor input)	± 0.002
ORP, Redox	Measuring range	-2000..2000 mV
	Resolution	0.1 mV
	Accuracy (sensor input)	± 0.1 / 1 mV
	Units	mV, rel. mV
Ion	Measuring range	1.00e-09...9.99e+09
	Resolution	3 or 4 digits (auto-range)
	Accuracy (sensor input)	± 0.5%
	Units	mg/L, mmol/L, mol/L, %, ppm, pX
Temperature	Measuring range	-5...130 °C (ATC)
		-30...130 °C (MTC)
	Resolution	0.1 °C
	Accuracy (sensor input)	± 0.2 °C
		± 0.5 °C if T < 0 °C or T > 105 °C
ATC/MTC	Yes	

Calibration (pH)	Calibration points	5
	Predefined buffer groups	8
	User-defined buffer groups	Yes (1)
	Automatic buffer recognition	Yes
	Calibration methods	Linear, segmented
Calibration (Ion)	Calibration points	5
	User-defined Ion-standards	1
	Calibration methods	Linear, segmented

13 Product Portfolio

13.1 Meter and kit versions

Parts	Order No.
Seven2Go™ pH/Ion meter S8 ONLY ¹⁾	30207874
S8-Standard Kit Seven2Go™ pH/Ion meter S8-Standard Kit with InLab® Expert Pro-ISM®	30207875
S8-Field Kit Seven2Go™ pH/Ion meter S8-Field Kit with InLab® Expert Pro-ISM and uGo™ carrying case	30207877
S8-Biotech Kit Seven2Go™ pH/Ion meter S8-Biotechnology Kit with InLab® Routine Pro-ISM	30207878
S8-Fluoride Kit Seven2Go™ pH/Ion meter S8-Fluoride Kit2 with perfectION™ Fluoride and uGo™ carrying case	30207879

¹⁾ **Including:**

- 1 x CD with operating instructions
- 1 x QuickGuide
- 1 x Declaration of conformity
- 1 x Test certificate
- 1 x Wrist strap
- 1 x Electrode assembly
- 1 x USB cable
- 1 x Meter base
- 1 x LabX direct CD
- 1 x Set of buffers

13.2 Accessories

Parts	Order No.
uGo™ carrying case	30122300
Seven2Go™ meter benchtop stabilizing base	30122303
Seven2Go™ electrode clip and electrode clip covers (4 pcs.)	30137805
Seven2Go™ wrist strap	30122304
Electrode arm uPlace™ (complete)	30019823
Power adapter for USB cable (to operate instrument without batteries)	30207980
InLab® Expert Pro-ISM, 3-in-1 pH sensor, PEEK shaft, ATC, low-maintenance, fixed cable 1.8 m	51344102
InLab® Solids Pro, 3-in-1 pH sensor, glass shaft, puncture electrode tip, ATC, low-maintenance, fixed cable 1.8m	51343156
InLab® Routine Pro-ISM, 3-in-1 pH sensor, glass shaft, ATC, refillable, MultiPin head	51343054
InLab® Versatile Pro, 3-in-1 pH sensor, Polysulfone shaft, ATC, refillable, fixed cable 1.2 m, not IP67	51343031
Electrode cable MultiPin-BNC/RCA (IP67) for electrodes with MultiPin head, ISM ready	30209921

Solutions	Order No.
pH 2.00 buffer sachets, 30 x 20 mL	30111134
pH 2.00 buffer solution, 250 mL	51350002
pH 2.00 buffer solution, 6 x 250 mL	51350016
pH 4.01 buffer sachets, 30 x 20 mL	51302069
pH 4.01 buffer solution, 250 mL	51350004
pH 4.01 buffer solution, 6 x 250 mL	51350018
pH 7.00 buffer sachets, 30 x 20 mL	51302047
pH 7.00 buffer solution, 250 mL	51350006
pH 7.00 buffer solution, 6 x 250 mL	51350020
pH 9.21 buffer sachets, 30 x 20 mL	51302070
pH 9.21 buffer solution, 250 mL	51350008
pH 9.21 buffer solution, 6 x 250 mL	51350022
pH 10.01 buffer sachets, 30 x 20 mL	51302079
pH 10.01 buffer solution, 250 mL	51350010
pH 10.01 buffer solution, 6 x 250 mL	51350024
pH 11.00 buffer sachets, 30 x 20 mL	30111135
pH 11.00 buffer solution, 250 mL	51350012
pH 11.00 buffer solution, 6 x 250 mL	51350026
Rainbow sachets I (10 sachets of pH 4.01 / 7.00 / 9.21)	51302068
Rainbow sachets II (10 sachets of pH 4.01 / 7.00 / 10.00)	51302080
Rainbow bottles I (2 x 250 mL of pH 4.01 / 7.00 / 9.21)	30095312
Rainbow bottles II (2 x 250 mL of pH 4.01 / 7.00 / 10.00)	30095313
InLab storage solution (for all InLab pH and redox electrodes), 250 mL	30111142
Electrolyte 3 mol/L KCl, 25 mL	51343180
Electrolyte 3 mol/L KCl, 250 mL	51350072
Electrolyte 3 mol/L KCl, 6 x 250 mL	51350080
HCl/Pepsin solution (removes protein contamination), 250 mL	51350100
Regeneration solution for pH electrodes, 25 mL	51350104
Thiourea solution (removes silver sulfide contamination), 250 mL	51350102
Software	Order No.
LabX®direct pH PC software	51302876

14 Appendix

14.1 Buffers

METTLER TOLEDO USA (Ref. 25°C)

T [°C]	1.68	4.01	7.00	10.01
5	1.67	4.00	7.09	10.25
10	1.67	4.00	7.06	10.18
15	1.67	4.00	7.04	10.12
20	1.68	4.00	7.02	10.06
25	1.68	4.01	7.00	10.01
30	1.68	4.01	6.99	9.97
35	1.69	4.02	6.98	9.93
40	1.69	4.03	6.97	9.89
45	1.70	4.04	6.97	9.86
50	1.71	4.06	6.97	9.83

METTLER TOLEDO Europe (Ref. 25°C)

T [°C]	2.00	4.01	7.00	9.21	11.00
5	2.02	4.01	7.09	9.45	11.72
10	2.01	4.00	7.06	9.38	11.54
15	2.00	4.00	7.04	9.32	11.36
20	2.00	4.00	7.02	9.26	11.18
25	2.00	4.01	7.00	9.21	11.00
30	1.99	4.01	6.99	9.16	10.82
35	1.99	4.02	6.98	9.11	10.64
40	1.98	4.03	6.97	9.06	10.46
45	1.98	4.04	6.97	9.03	10.28
50	1.98	4.06	6.97	8.99	10.10

MERCK (Ref. 20°C)

T [°C]	2.00	4.00	7.00	9.00	12.00
5	2.01	4.04	7.07	9.16	12.41
10	2.01	4.02	7.05	9.11	12.26
15	2.00	4.01	7.02	9.05	12.10
20	2.00	4.00	7.00	9.00	12.00
25	2.00	4.01	6.98	8.95	11.88
30	2.00	4.01	6.98	8.91	11.72
35	2.00	4.01	6.96	8.88	11.67
40	2.00	4.01	6.95	8.85	11.54
45	2.00	4.01	6.95	8.82	11.44
50	2.00	4.00	6.95	8.79	11.33

JIS Z 8802 (Ref. 25°C)

T [°C]	1.679	4.008	6.865	9.180
5	1.668	3.999	6.951	9.395
10	1.670	3.998	6.923	9.332
15	1.672	3.999	6.900	9.276
20	1.675	4.002	6.881	9.225
25	1.679	4.008	6.865	9.180
30	1.683	4.015	6.853	9.139
35	1.688	4.024	6.844	9.102
40	1.694	4.035	6.838	9.068
45	1.700	4.047	6.834	9.038
50	1.707	4.060	6.833	9.011

DIN(19266) NIST (Ref. 25°C)

T [°C]	1.68	4.008	6.865	9.183	12.454
5	1.668	4.004	6.950	9.392	13.207
10	1.670	4.001	6.922	9.331	13.003
15	1.672	4.001	6.900	9.277	12.810
20	1.676	4.003	6.880	9.228	12.627
25	1.680	4.008	6.865	9.183	12.454
30	1.685	4.015	6.853	9.144	12.289
35	1.691	4.026	6.845	9.110	12.133
40	1.697	4.036	6.837	9.076	11.984
45	1.704	4.049	6.834	9.046	11.841
50	1.712	4.064	6.833	9.018	11.705

DIN(19267) (Ref. 25°C)

T [°C]	1.09	4.65	6.79	9.23	12.75
5	1.08	4.67	6.87	9.43	13.63
10	1.09	4.66	6.84	9.37	13.37
15	1.09	4.66	6.82	9.32	13.16
20	1.09	4.65	6.80	9.27	12.96
25	1.09	4.65	6.79	9.23	12.75
30	1.10	4.65	6.78	9.18	12.61
35	1.10	4.65	6.77	9.13	12.45
40	1.10	4.66	6.76	9.09	12.29
45	1.10	4.67	6.76	9.04	12.09
50	1.11	4.68	6.76	9.00	11.98

JJG119 (Ref. 25°C)

T [°C]	1.680	4.003	6.864	9.182	12.460
5	1.669	3.999	6.949	9.391	13.210
10	1.671	3.996	6.921	9.330	13.011
15	1.673	3.996	6.898	9.276	12.820
20	1.676	3.998	6.879	9.226	12.637
25	1.680	4.003	6.864	9.182	12.460
30	1.684	4.010	6.852	9.142	12.292
35	1.688	4.019	6.844	9.105	12.130
40	1.694	4.029	6.838	9.072	11.975
45	1.700	4.042	6.834	9.042	11.828
50	1.706	4.055	6.833	9.015	11.697

Technical (Ref. 25°C)

T [°C]	2.00	4.01	7.00	10.00
5	2.01	4.01	7.09	10.65
10	2.00	4.00	7.06	10.39
15	2.00	4.00	7.04	10.26
20	2.00	4.00	7.02	10.13
25	2.00	4.01	7.00	10.00
30	1.99	4.01	6.99	9.87
35	1.99	4.02	6.98	9.74
40	1.98	4.03	6.97	9.61
45	1.98	4.04	6.97	9.48
50	1.98	4.06	6.97	9.35

To protect your product's future:

METTLER TOLEDO Service assures the quality, measuring accuracy and preservation of value of this product for years to come.

Please request full details about our attractive terms of service.

www.mt.com/ph

For more information

Mettler-Toledo AG, Analytical

CH-8603 Schwerzenbach, Switzerland

Tel. +41 (0)44 806 77 11

Fax +41 (0)44 806 73 50

www.mt.com

Subject to technical changes.

© Mettler-Toledo AG 08/2014

30219749A

