

# Balor 17F-12

sCMOS

Capture More. Further. Faster.

## Key Applications

- ✓ Orbital Debris Tracking
- ✓ Asteroid Tracking
- ✓ Solar Studies
- ✓ Exoplanet Discovery
- ✓ Supernovae Detection
- ✓ Atmospheric Studies
- ✓ Speckle/Lucky Imaging
- ✓ Large Sky Surveys

## Key Specifications

- ✓ Low noise sCMOS
- ✓ 16.9 MP - Very large Field of View
- ✓ Exceptionally fast 18.5 ms readout
- ✓ Up to 54 fps
- ✓ Vacuum protected - minimal downtime
- ✓ Shutter-free technology

# Introducing Balor

## A Revolutionary, Very Large Field of View, Fast Readout sCMOS Detector for Astronomy



Many challenges in modern astronomy require not only high resolution, large field of view and superb sensitivity - they also require speed. However, large area CCD technology is very much performance-limited in this regard, typically requiring more than 40 seconds to readout a single frame with low noise.

The **NEW Balor sCMOS platform** addresses this fundamental application shortfall, perfect for measuring photometric and astrometric variability across timescales ranging from milliseconds to tens of seconds.

***Exceptionally fast 18.5 ms readout. Avoid lengthy readout periods...  
Capture photons instead!***

**Balor 17F-12**, utilizing a sensor that is unique to Andor, is capable of ripping along at up to 54 frames per second at full 16.9 MP resolution, whilst remarkably, maintaining an exceptionally low < 3 electrons read noise. The large 12  $\mu\text{m}$  pixels offer large well depth and an on-chip multi-amplifier design means the whole photometric range, from the noise floor up to the saturation limit, can be captured with one image, ideal for quantifying across a range of magnitudes.

With a **70mm sensor diagonal**, Balor 17F-12 is the largest commercially available sCMOS camera, designed for '**dynamic astronomy**' applications such as Orbital Debris tracking, Solar Astronomy, Solar System Object detection, Exoplanet Discovery, Atmospheric Studies and Fast Time Resolution Astrophysics. Balor also lends itself particularly well to the 'atmospheric freezing' techniques of Lucky/Speckle Imaging, enabling resolution enhancement of ground-based astronomy over a much larger field of view than is readily achievable through use of adaptive optics.

The perfect solution for **Large Sky Surveys** that measure photometric and astrometric **variability** across timescales ranging from **milliseconds** to **tens of seconds**.



Cover Image Credit: The Daniel K. Inouye Solar Telescope has produced the highest resolution image of the Sun's surface ever taken using Balor sCMOS. In this picture taken at 789 nm, we can see features as small as 30 km (18 miles) in size for the first time ever. The image shows a pattern of turbulent, "boiling" gas that covers the entire sun. The cell-like structures - each about the size of Texas - are the signature of violent motions that transport heat from the inside of the sun to its surface. Hot solar material (plasma) rises in the bright centers of "cells," cools off and then sinks below the surface in dark lanes in a process known as convection. In these dark lanes we can also see the tiny, bright markers of magnetic fields. Never before seen to this clarity, these bright specks are thought to channel energy up into the outer layers of the solar atmosphere called the corona. These bright spots may be at the core of why the solar corona is more than a million degrees! This image covers an area 36,500 x 36,500 km (22,600 x 22,600 miles, 51 x 51 arcseconds). Credit: NSO/AURA/NSF

## Balor in Irish Mythology

Long ago, in ancient times, supernatural beings called the Fomorians ruled over Ireland. Balor, the deadliest and most feared of the Fomorian kings, wreaked destruction on anything that dared to cross his deadly gaze. But in the battle of Mag Tuired, Balor fell when a spear was cast through his eye. Face down, his body burned a hole in the earth, which filled with water to become Loch na Súil: The lake of the eye.

As a new day dawns, the great Balor has been resurrected to help Astronomers fight a different battle. A battle of exploration beyond the boundaries of our planetary home. [Find out more here.](#)



## Features & Benefits Summary

Feature	Benefit
<b>49.5 x 49.2 mm sensor</b>	Very large field of view from 16.9 Megapixel, 12 $\mu\text{m}$ pixel pitch sensor.
<b>18.5 millisecond readout</b>	Readout a 4k x 4k sensor 2500x faster than a CCD. Spend time capturing scarce photons instead!
<b>Up to 54 fps</b>	Unique solution for a range of high time-resolution observing challenges, without compromising noise or FOV.
<b>Extended Dynamic Range and &gt; 99.7% Linearity</b>	Superb quantitative accuracy across a wide range of magnitudes within a single image.
<b>Readout noise ~ 2.9 e-</b>	Exceptionally low noise, even at max frame rate, suited to short exposure, low light observational challenges.
<b>80 000 e- well depth</b>	High well depth for quantification of bright signals.
<b>UltraVac™ 0.1</b>	Critical for sustained vacuum integrity and to maintain unequalled cooling and QE performance, year after year.
<b>CoaXPress as standard</b>	4 Lane CXP-6 interface enabling the highest frame rates over distances up to 30 m.
<b>Rolling and Global shutter supported</b>	Maximum exposure and readout flexibility across all applications. Global Shutter for snapshot capture of fast moving/changing events.
<b>No mechanical shutter</b>	Balor requires no mechanical shutter, thus avoids the downtime associated with shutter replacements.
<b>IRIG-B GPS timestamp</b>	Image GPS timestamp with 10 ns resolution for syncing across multiple instruments and multiple observation sites.
<b>Fully Enclosed Casing (optional)</b>	Reduced thermal bloom from Liquid Cooled Only variant; minimal effect on nearby optics and enclosed environmental temperature.

# Key Features

## Very Large Field of View

70 mm sensor diagonal covers more sky at high resolution, improving statistics of detection. Ideal for large sky surveys.

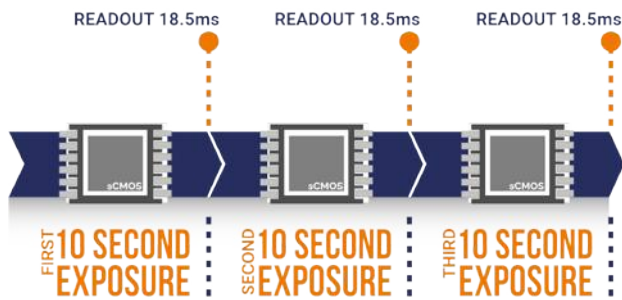

## Fast Sensor Readout

Taking only 18.5 milliseconds per full frame readout, Balor 17F-12 can measure variability across a wide range of timescales, including fast solar dynamics. Also possible to maximize SNR by using longer exposures (10 - 60 s) and still achieve frame cycle times much faster than CCDs - ideal for exoplanet discovery!

## Extended Dynamic Range

Large pixel well-depth and an on-chip multi-amplifier design means the whole photometric range, from the noise floor up to the saturation limit, can be captured with one image. The wide dynamic range is complemented by enhanced on-head intelligence to deliver linearity > 99.7%, for unparalleled quantitative accuracy of measurement across the full signal range. Such capability is ideal for photometric accuracy of light curve measurements across a wide range of magnitudes.

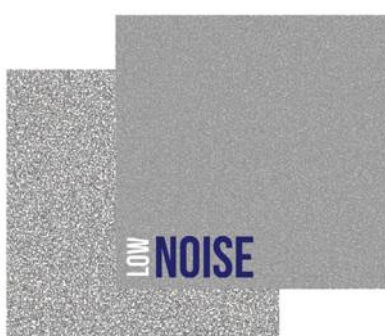

## Low Noise

The parallel readout architecture and innovative pixel design enables Balor to drive very low read noise performance, < 3 e-, while still achieving maximum readout speed. Ideal for detecting weak signal from small Solar System objects.

# Key Features

## Vacuum Sensor Enclosure

sCMOS cameras from other manufacturers use O-ring sealed, back-filled sensor enclosures, susceptible to moisture ingress and routine factory maintenance. Andor is the only manufacturer of vacuum enclosed sCMOS cameras, based on our proven UltraVac™ process, offering superior cooling and ultimate sensor protection. Expect the vacuum to hold firm, year after year.

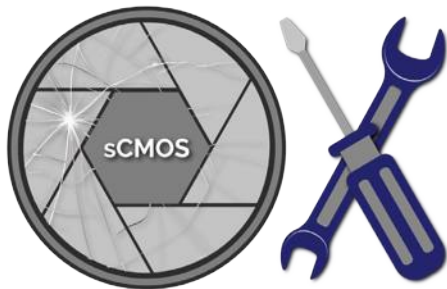
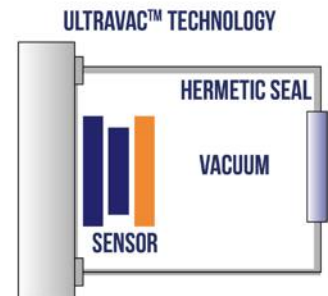

## No Mechanical Shutter

Applications that involve frequent cycling of mechanical shutters, such as exoplanet studies, require routine shutter replacements and associated down time. Balor offers on-sensor Rolling and Global Shutter options, thus overcomes the need for mechanical shutters. Furthermore, this avoids the exposure gradient effects associated with that of an iris shutter, thus much better for accurate photometry.

## IRIG-B GPS Timestamp

GPS timestamp with 10 nanosecond granularity, for temporal synchronisation across multiple instruments or multiple sites.



## Low Maintenance Astronomy

The vacuum enclosure and shutter-free longevity benefits of Balor are particularly relevant to the needs of astronomers, where cameras are often in remote unmanned observing locations and need to operate without service intervention, over long durations of time. This ultimately translates not only into greater experimental efficiency, but also into a lower cost of ownership.

# Application Focus

## Solar Studies

It is vital we attempt to understand the underlying processes behind our nearest star! Balor allows ground-breaking observations of the solar atmosphere with unprecedented spatial and temporal resolution. Solar astronomers can study the nuances of dynamic events such as magnetic reconnection with stunning accuracy, while also having the large-format capability to view entire flux ropes and sunspots without mosaicking.



## Orbital Debris

Orbital Debris, or Space Debris, are terms for the mass of defunct human-made objects in Earth orbit, such as old satellites and spent rocket stages. There are about 500,000 pieces of 'space junk' down to items about 1.3 cm wide in orbit. Of those, about 21,000 objects are larger than 10 cm in diameter. Balor's very large area offers a superb detector solution for ground based Orbital Debris tracking, capable of searching more sky while maintaining high resolving capability. Low noise enables high-quality data capture of even relatively small (and dim) objects, and rapid frame rates enable temporal oversampling of fast moving/rotating objects.



## Solar System Objects

A Near-Earth Object (NEO) is any small Solar System body whose orbit brings it into proximity with Earth. Over 20,000 known Near Earth Asteroids have been discovered, of which almost 1000 are larger than 1 km. The inventory is much less complete for smaller objects, which still have potential for large scale damage. While asteroids are constantly eliminated from our solar system, new asteroids continue to enter it! Thus, NEO surveys are required as an ongoing discipline in astronomy. The very large field of view, low noise and fast readout of Balor are ideal for increasing the probability of successful object detection, either via direct visualisation or occultation.

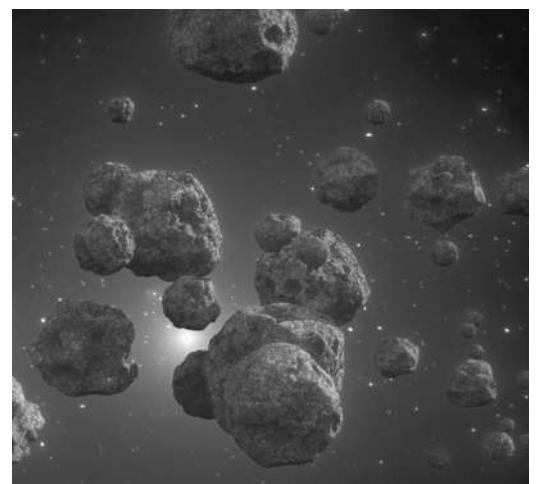

# Application Focus

## Exoplanet Discovery

### Enhanced SNR and Temporal Resolution

Photometric exposure times in the tens of seconds are commonplace for transit or radial velocity measurements. When performed with a 4k x 4k format CCD with 4 output ports, a low noise readout requires an additional 45 seconds on top of the exposure. Balor has an 18.5 ms low noise readout, approximately 2500x faster than a CCD!

The exposure scheme below shows how, using a 10 sec exposure time, the measurement cycle time can be significantly shortened with Balor. Even when we lengthen the Balor exposure time to 15 sec to achieve the same SNR as a back-illuminated CCD, the duty cycle remains much shorter. Thus, Balor is an opportunity for enhanced SNR and temporal resolution combined. Balor also avoids the need for routine replacement of mechanical shutters.

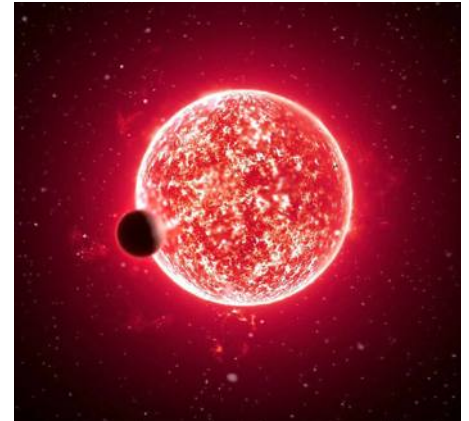

### Balor 4k x 4k sCMOS - 'low noise readout'

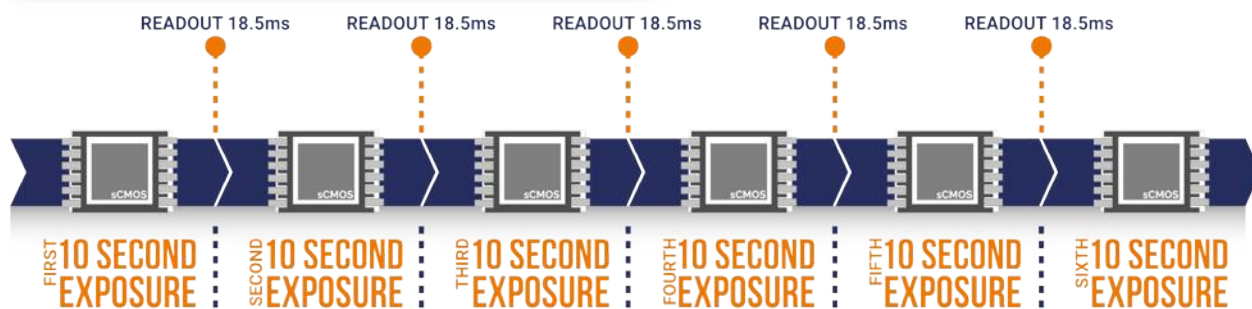

### 4k x 4k CCD (4 output ports) - 'low noise readout'

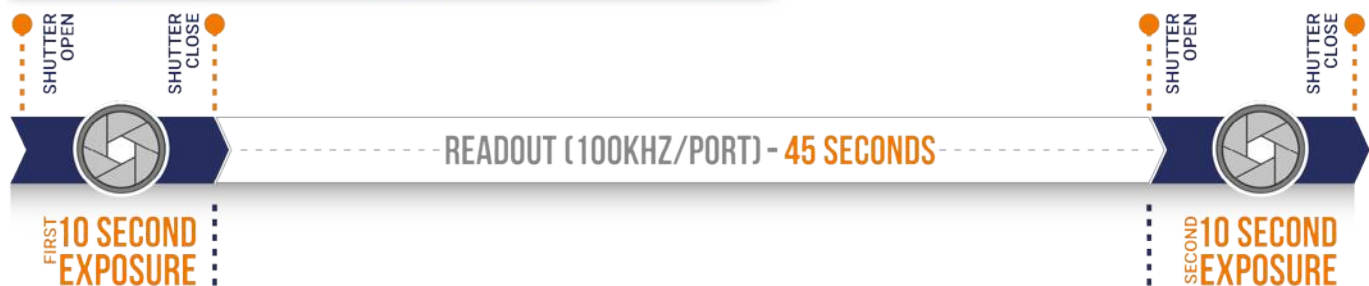

## Resolution Enhancement

Balor lends itself particularly well to 'Atmospheric Freezing' techniques of Lucky/Speckle Imaging, enabling resolution enhancement of ground-based astronomy over a much larger field of view than is readily achievable through use of adaptive optics. The 54 fps (full array) with 100% duty cycle means that enhanced resolution images can be generated within a few seconds of acquisition. Faster speeds through ROIs can be employed to perform enhanced resolution photometry with sub-second temporal resolution.

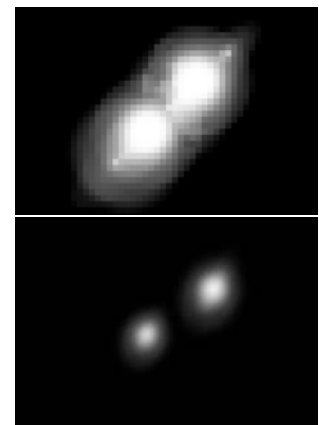

# Technical Data

## System Specifications <sup>•2</sup>

<b>Sensor Type</b>	Large area, Front-illuminated sCMOS
<b>Array Size</b>	4128 (W) x 4104 (H)
<b>Pixel Size</b>	12 x 12 $\mu\text{m}$
<b>Image Area</b>	49.5 mm x 49.2 mm (69.9 mm diagonal)
<b>Readout Modes</b>	Rolling Shutter and Global Shutter
<b>System window type</b>	AR coated UV grade fused silica window (>98% transmission)
<b>Interface</b>	CoaXPress (4 Lane CXP-6)
<b>I/O</b>	Fire Row1, Fire Row N, Fire All, Fire Any, Arm, Shutter, Ext Trigger
<b>Trigger Modes</b>	Internal, External, External Start, External Exposure, Software

## Advanced Performance Specifications <sup>•2</sup>

	Rolling Shutter	Global Shutter
<b>Dark Current <sup>*4</sup></b>	0.35 e <sup>-</sup> /pix/sec (@ 0°C) 0.08 e <sup>-</sup> /pix/sec (@ -10°C) 0.03 e <sup>-</sup> /pix/sec (@ -30°C)	0.5 e <sup>-</sup> /pix/sec (@ 0°C) 0.15 e <sup>-</sup> /pix/sec (@ -10°C) 0.065 e <sup>-</sup> /pix/sec (@ -30°C)
<b>Read Noise (e<sup>-</sup>) median</b>	2.9 e <sup>-</sup>	4.3 e <sup>-</sup>
<b>Active area pixel well depth</b>	80 000 e <sup>-</sup>	
<b>Peak QE <sup>*5</sup></b>	61% (@ ~ 600 nm)	
<b>Photon response non-uniformity (PRNU)</b>	< 0.5% (@ half well depth)	
<b>Region of Interest</b>	User-definable, 1 pixel granularity	
<b>Linearity <sup>*6</sup></b>	> 99.7%	
<b>Data Range</b>	16-bit	
<b>f-number</b>	0.35 (Cone Angle 110°)	

## Cooling Options and Specifications <sup>•3</sup>

Balor has two variants for cooling: Liquid Cooled Only and Flexi Cooled. Flexi offers both air and liquid cooling capability, and both variants offer the same liquid cooling temperature of -30°C. However, the Liquid Cooled Only variant is supplied without air vents, useful for minimizing any residual thermal bloom from the camera body in extremely temperature controlled environments, such as in Radial Velocity experiments.

During air cooling, the user must be aware of the ambient air temperature and altitude at which the camera is operated as both will have an impact on the extent of sensor cooling. The table below offers a guide to selecting the available sensor cooling set points under different environmental conditions. The table also shows the recommended liquid temperature with minimum flow rate of 2 L·min<sup>-1</sup> in order to achieve -30°C sensor temperature for both the Liquid Cooled Only and Flexi cooled systems.

Sensor Temperature	-30°C (Liquid)	-10°C (Air)	0°C (Air)
<b>Altitude</b>	<b>Liquid cooling</b> (recommended coolant temperature)	<b>Air Cooling</b> (maximum ambient air temperature)	
<b>Sea level</b>	16°C	25°C	30°C
<b>&lt; 3000 m</b>	16°C	15°C	20°C
<b>&lt; 6000 m</b>	16°C	5°C	10°C



## QE Curve

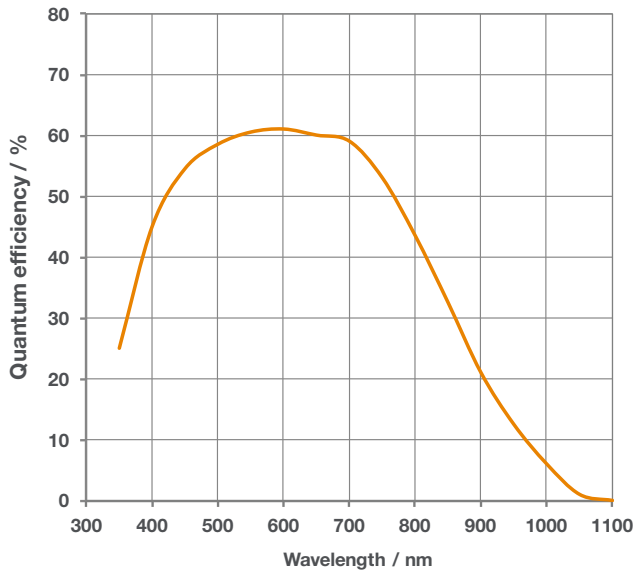

**Balor 17F-12 does not suffer etaloning effects across the important NIR wavelength range, preserving accurate photometry and spectroscopy**

## Frame Rates

### Imaging ROI: Rolling Shutter [Global Shutter]

ROI Size (W x H)	Max Frame Rate (fps)	
	16-bit 100% Duty Cycle*	16-bit
4128 x 4104	54 [34]	44 [34]
2048 x 2048	108 [68]	88 [68]
1920 x 1080	205 [126]	167 [127]
1024 x 1024	216 [132]	176 [134]
512 x 512	431 [252]	350 [258]
128 x 128	1684 [785]	1337 [840]

Note: All frame rates assume internal trigger.

## Development of Balor

Balor was initiated through the solar physics research programmes undertaken at Queen's University Belfast, and developed in collaboration with staff in the Queen's Astrophysics Research Centre, University College London, Armagh Observatory, Northumbria University, University of Glasgow, University of Sheffield, University of St Andrews, University of Warwick and the US National Solar Observatory, from funding provided by the Science and Technology Facilities Council, part of UK Research and Innovation.

## Flexible Connectivity

- 1 CoaXPress**  
CoaXPress (4 lane) offers the highest speed data interface
  - 2 IRIG-B**  
Compatible with IRIG-B standard (GPS with 10 ns resolution)
  - 3 I/O (TTL / Logic)**  
Connector type: D-type, provided with SMB - BNC cable  
Fire (Output), External Trigger (Input), Shutter (Output), Aux Out 1\*, Aux Out 2\* and ARM\*. \* Requires optional 7-way cable.
  - W Water Cooling**  
Connection to recirculator or other water/liquid cooling system
  - P Power**  
Connection to PSUs refer to power requirements on page 12
- Notes:** Ensure 100 mm clearance around camera vents (Flexi model only) and power supply vents.

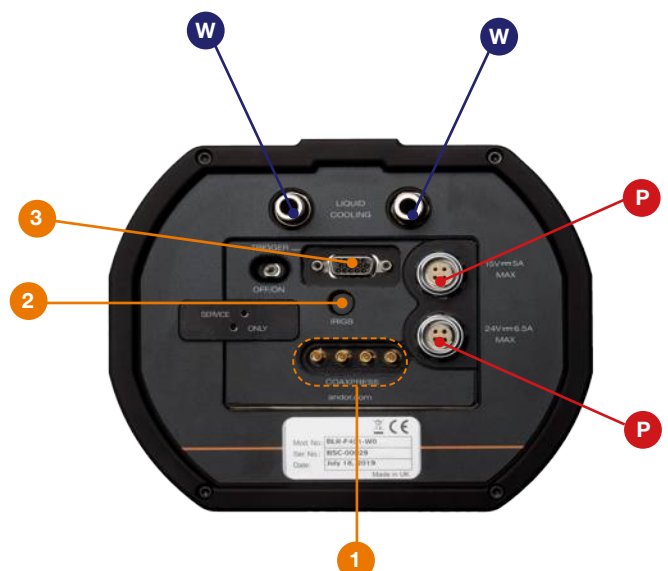

# Creating The Optimum Product for You



BLR- F401 - **W**  
example shown

**Step 1. Choose the sensor type option**

There is one sensor type available for the Balor 17F-12:

Description	Code
16.9 Megapixel Front-illuminated sCMOS camera	F401

Sensor Type

**Step 2. Choose the cooling option**

Description	Code
Flexi Cooling model (liquid or air) (cooling -30°C with liquid coolant; cooling -10°C with air cooling)	F
Liquid Cooled Only model (cooling -30°C with liquid coolant)	W

Cooling

**Step 3. Select the required software**

**Balor 17F-12 requires at least one of the following software options:**

**Solis for Imaging** 64-bit enabled application for Windows (8, 8.1 and 10), offering complete functionality for data acquisition and processing. AndorBasic provides macro language control of data acquisition, processing, display and export.

**Andor SDK** Andor SDK3 A software development kit that allows you to control the Andor sCMOS cameras from your own application. Available as 64-bit libraries for Windows (8, 8.1 and 10) and Linux. Compatible with C/C++, LabView and Matlab.

**Linux:** Linux CentOS 7.5 64-bit (with kernel version no higher than 4.6)

**Step 4. Select accessories**

Description	Order Code
Trigger cable, D-type to BNC, 7-way multi I/O timing interface cable gives access to all I/O functions.	ACC-ACZ-05612
CoaXPress cable: 25 m (4x cable composite)	ACC-ASE-14327
CoaXPress cables: 30 m cables (set of 4x individual cables supplied)	ACC-ASE-14330-4
IRiG-B BNC to SMA Cable: 2 m	CABL-BNC020SMA

Accessories

Please contact your local sales representative regarding other options such as different mounting types, camera window options or other customizations you may require for system integration or your specific application.

## Have you found what you are looking for?

**Need more sensitivity?** (a) The [Marana 4.2-11](#) back-illuminated sCMOS camera combines a large field of view sensor with up to 95% QE, ideal for tracking the smallest objects and for measuring photometric variability on very dim stars. (b) The [iXon Ultra EMCCD](#) platform offers single photon sensitivity and 95% back-illuminated QE, further boosted by cooling to as low as -100°C, ideal for the most light starved of faster frame rate applications (1 fps up to 100's fps).



**Need a larger dynamic range?** (a) The [iKon-XL 231](#) with CCD 231-84 sensor offers down to 2 e- read noise and 350,000 e- well depth. (b) For high dynamic range at faster frame rates, the Marana sCMOS is capable of measuring photometric variability with superb accuracy, across a wide range of magnitudes.

**Need improved sensitivity in the Near IR region?** The [iKon-XL 231](#) with CCD 231-84 sensor offers deep-depletion options that provide optimal sensitivity in the Near IR, ideal for photometry of cooler dwarf stars.

**Need smaller pixels?** For telescopes that are optimized for Nyquist with smaller pixels, the [Neo](#) and [Zyla](#) sCMOS cameras offer sensors with 6.5 µm pixel pitch.

# Mechanical Drawings

Dimensions in mm [inches]

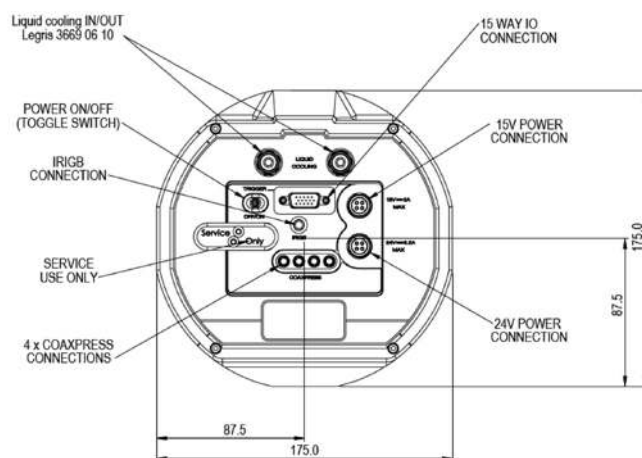
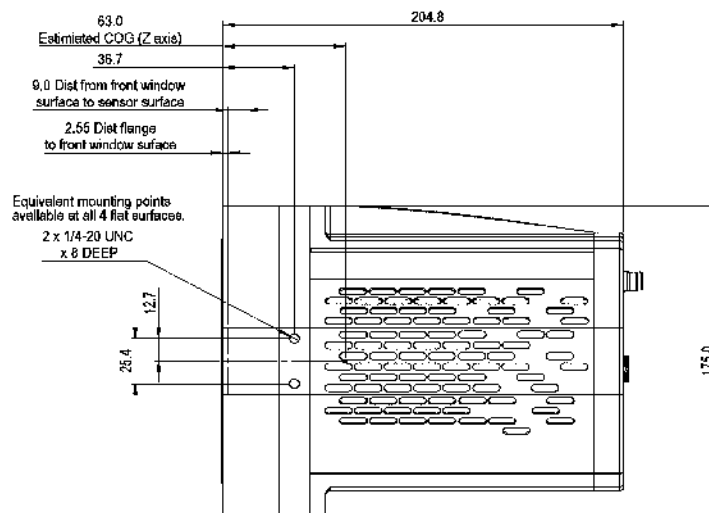
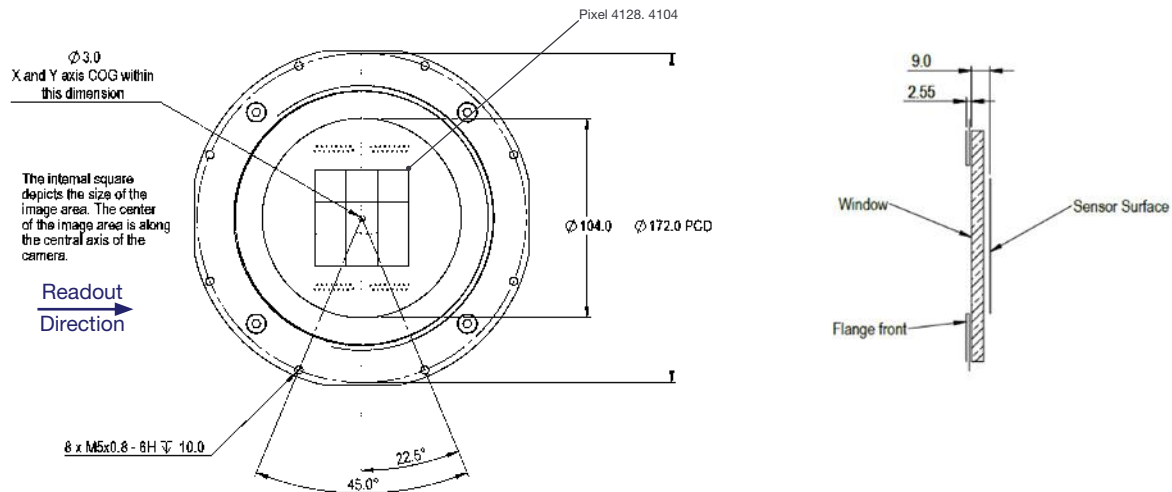

## Weight (approx):

Liquid Cooled Only: ~9 kg

Flexi Cooled: ~9 kg

Abbreviation	Meaning
--------------	---------

COG	Centre of Gravity
PCD	Pitch Circle Diameter
UNC	Unified National Coarse Thread Standard

Note: air vents are not present in the housing of the Liquid Cooled Only model (not shown). This option can be selected for minimal thermal bloom.

# Order Today

Need more information? At Andor we are committed to finding the correct solution for you. With a dedicated team of technical advisors, we are able to offer you one-to-one guidance and technical support on all Andor products.

For a full listing of our local sales offices, please see: [andor.com/contact](http://andor.com/contact)

## Our regional headquarters are:

### Europe

Belfast, Northern Ireland  
Phone +44 (28) 9023 7126  
Fax +44 (28) 9031 0792

### Japan

Tokyo  
Phone +81 (3) 6732 8968  
Fax +81 (3) 6732 8939

### North America

Concord, MA, USA  
Phone +1 (860) 290 9211  
Fax +1 (860) 290 9566

### China

Beijing  
Phone +86 (10) 5884 7900  
Fax +86 (10) 5884 7901

## Items shipped with your camera

- 1x Cyton-CXP card
- 1x CoaXPress cable (3 m)
- 1x Trigger cable (BNC to SMB: 2 m)
- 1x Trigger cable (3-way, D-type to BNC: 1.5 m)
- 2x Country specific power cords
- 2x PSU (15 V: 1.5 m, 24 V: 1.2 m)
- 1x User manuals in electronic format
- 1x Quickstart Guide
- 1x Individual system performance booklet

## Footnotes

1. Assembled in a state-of-the-art facility, Andor's UltraVac™ vacuum process combines a permanent hermetic vacuum seal (no o-rings), with a stringent protocol and proprietary materials to minimize outgassing. Outgassing is the release of trapped gases that would otherwise degrade cooling performance and potentially cause sensor failure.
2. Figures are typical and target specifications and therefore subject to change.
3. Specified minimum temperature with coolant assumes coolant temperature of 16°C at a flow rate of 2 litres per minute, measured at the camera head. Air cooling performance is at the ambient temperature listed. Note that cooling performance may be affected by the distance between camera head and coolant system.
4. Dark current are typical median values, measurement is averaged over the sensor area excluding any regions of blemishes.
5. Quantum efficiency as supplied by the sensor manufacturer.
6. Linearity is measured from a plot of Signal vs. Exposure Time as per EMVA 3.0.
7. 100% duty cycle, after each row is read out, the next exposure is immediate.

[andor.com](http://andor.com)

### Minimum Computer Requirements:

- 3.0 GHz quad core processor or equivalent
- 16 GB RAM
- Hard drive: 3 GB/sec or greater write speed recommended for the data rate associated with the max. frame rates. 200 MB free hard disc to install software
- x8 PCIe Gen 2 slot
- Windows (8, 8.1 and 10) or Linux 64-bit OS

### Operating & Storage Conditions:

- Operating Temperature: -30°C to +30°C ambient
- Operating Altitude: up to 6000 m
- Relative Humidity: <70% (non-condensing)
- Storage Temperature: -30°C to 50°C

### Power Requirements:

- 100 - 240 VAC, 50 - 60 Hz
- Power Consumption: 236 W max



Windows is a registered trademark of Microsoft Corporation.  
Labview is a registered trademark of National Instruments.  
Matlab is a registered trademark of The MathWorks Inc.